



519

TV

519

T.			U_f		U_a	U_g	\emptyset	
			V	A			V	mm
CRM 151	Maz	1	2	1,4	12000 13000	-59 ÷ -127 -300	15 maximum	381
CRM 152 A	Maz	2	2	1,4				
CRM 152 B	Maz	2	2	1,4				
C 15 B	Bri	3	2	2,5	10000	-60 ÷ -140	15	381
MT 136	CDC	4	4	1	6000	-27 ÷ -57	14	356
MT 136 A	CDC	4	4	1				
MT 336 A	CDC	2	6,3	0,8	{ 10000 15000	-15 ÷ -55 0 ÷ -125	14 maximum	356
65	Cos	5	4	1,1	5000	-42	15	381
65 K	Cos	6	4	1,1				
65 K/2	Cos	6	4	1,1				
40 ЛК 1 Б	СССР	7	6,3	0,55	12000	-60 ÷ -100	13 $\frac{13}{16}$	350
85 K	Cos	6	6,3	0,6	9000	-50	15	381
7201 A	GEC	2	6,3	0,3	14000	-70	14	356

T.	Fig.	A	B	C	D	E
		mm	mm	mm	mm	mm
CRM 151	2		381	403	175	35
CRM 152 A/B	2		381	306	190	35
MT 336 A	2		356	300	200	37
40 ЛК 1 Б	1	350	406	292	210	35

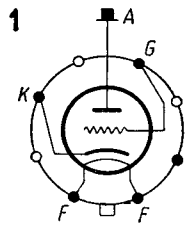
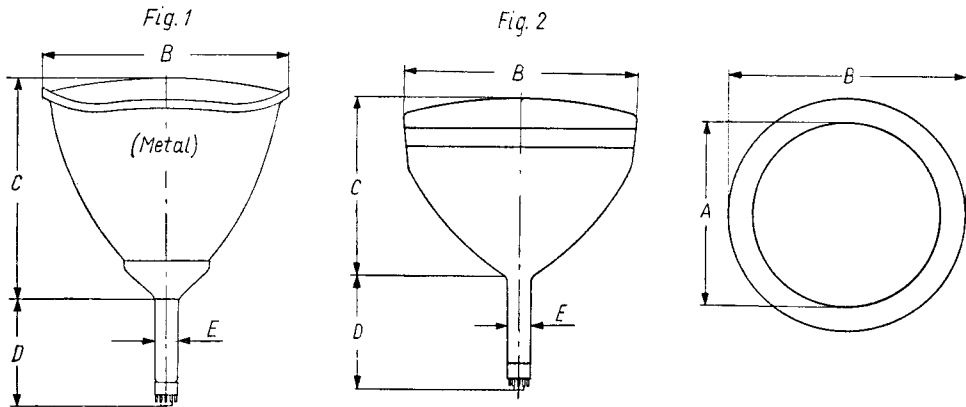

CRM 151

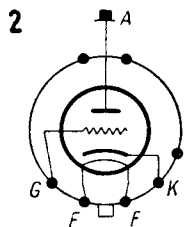

CRM 152A

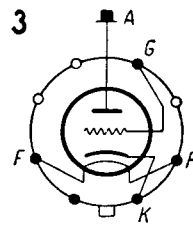

C15B

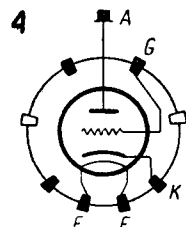

MT 136

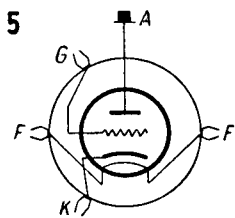

65

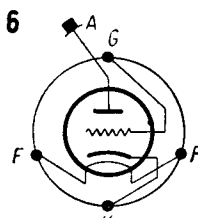

65K

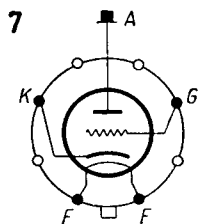

40ЛК1Б

