



EIMAC

A Division of Varian Associates
SAN CARLOS, CALIFORNIA

750TL
MEDIUM-MU TRIODE
•
MODULATOR
OSCILLATOR
AMPLIFIER

The Eimac 750TL is a medium-mu power triode intended for use as an amplifier, oscillator, or modulator. It has a maximum plate dissipation rating of 750 watts and a maximum plate voltage rating of 10,000 volts at frequencies up to 40 Mc. The 750TL is cooled by air-circulation and radiation.

The 750TL in class-C r-f service will deliver up to 3000 watts plate power output with 125 watts driving power. Two 750TL's in class-AB₂ modulator service will deliver up to 3500 watts maximum-signal plate power output with 46 watts driving power.

GENERAL CHARACTERISTICS

ELECTRICAL

	Min.	Nom.	Max.	
Filament: Thoriated Tungsten				
Voltage	-	7.5	-	volts
Current	-	20.0	-	22.7 amperes
Amplification Factor	-	14.5	-	16.5
Direct Interelectrode Capacitances:				
Grid-Plate	-	5.0	-	7.0 μ f
Grid-Filament	-	7.0	-	10.0 μ f
Plate-Filament	-	0.9	-	1.5 μ f
Transconductance ($I_b=250$ ma., $E_b=5000$ v.)	-	3500	-	μ mhos
Frequency for Maximum Ratings	-	-	-	40 mc

MECHANICAL

Base	-	-	-	-	-	-	-	-	Special 4-pin
Connections	-	-	-	-	-	-	-	-	See outline drawing
Socket	-	-	-	-	-	-	-	-	Johnson type No. 124-214 or equivalent
Mounting Position	-	-	-	-	-	-	-	-	Vertical, base down or up
Cooling	-	-	-	-	-	-	-	-	Air-circulation and radiation

Recommended Plate and Grid Heat-Dissipating Connectors	-	-	-	-	-	-	-	-	-	Eimac HR-8
Maximum Overall Dimensions:										
Length	-	-	-	-	-	-	-	-	-	17.0 inches
Diameter	-	-	-	-	-	-	-	-	-	7.13 inches
Net Weight (Average)	-	-	-	-	-	-	-	-	-	2.9 pounds
Shipping Weight (Average)	-	-	-	-	-	-	-	-	-	13 pounds

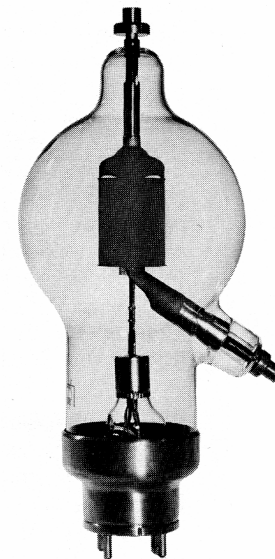

AUDIO-FREQUENCY POWER AMPLIFIER OR MODULATOR

Class-AB₂ (Sinusoidal wave)

MAXIMUM RATINGS (Per tube)

D-C PLATE VOLTAGE	-	-	-	-	10,000 MAX. VOLTS
D-C PLATE CURRENT	-	-	-	-	1000 MAX. MA
PLATE DISSIPATION	-	-	-	-	750 MAX. WATTS
GRID DISSIPATION	-	-	-	-	100 MAX. WATTS

TYPICAL OPERATION (Two tubes unless otherwise specified)

D-C Plate Voltage	-	-	-	4000	5000	6000	volts
D-C Grid Voltage ¹	-	-	-	-230	-320	-390	volts
Zero-Signal D-C Plate Current	-	-	-	250	200	166	ma.
Max-Signal D-C Plate Current	-	-	-	950	860	834	ma
Effective Load, Plate-to-Plate	-	-	-	8270	12,300	16,300	ohms
Peak A-F Grid Voltage (per tube)	-	-	-	490	560	650	volts
Max-Signal Driving Power*	-	-	-	38	28	46	watts
Max-Signal Plate Power Input	-	-	-	3800	4300	5000	watts
Max-Signal Plate Power Output	-	-	-	2300	2800	3500	watts

¹Adjust to stated zero-signal plate current.

RADIO-FREQUENCY POWER AMPLIFIER OR OSCILLATOR

Class-C Telephony or FM Telephony (Key-down conditions, per tube)

MAXIMUM RATINGS (Frequencies up to 40 Mc.)

D-C PLATE VOLTAGE	-	-	-	-	10,000 MAX. VOLTS
D-C PLATE CURRENT	-	-	-	-	1000 MAX. MA
PLATE DISSIPATION	-	-	-	-	750 MAX. WATTS
GRID DISSIPATION	-	-	-	-	100 MAX. WATTS

TYPICAL OPERATION (Frequencies up to 40 Mc.)

D-C Plate Voltage	-	-	-	3000	4000	5000	6000	volts
D-C Grid Voltage	-	-	-	-350	-450	-550	-700	volts
D-C Plate Current	-	-	-	713	625	600	625	ma
D-C Grid Current*	-	-	-	120	90	90	105	ma
Peak R-F Grid Voltage	-	-	-	805	885	985	1040	volts
Driving Power*	-	-	-	97	83	86	125	watts
Grid Dissipation*	-	-	-	55	40	38	50	watts
Plate Power Input	-	-	-	2140	2500	3000	3750	watts
Plate Power Output	-	-	-	1390	1750	2250	3000	watts

PLATE-MODULATED RADIO-FREQUENCY AMPLIFIER

CLASS-C TELEPHONY (Carrier conditions, per tube)

MAXIMUM RATINGS (Frequencies up to 40 Mc.)

D-C PLATE VOLTAGE	-	-	-	-	8000 MAX. VOLTS
D-C PLATE CURRENT	-	-	-	-	800 MAX. MA
PLATE DISSIPATION	-	-	-	-	500 MAX. WATTS
GRID DISSIPATION	-	-	-	-	100 MAX. WATTS

TYPICAL OPERATION (Frequencies up to 40 Mc.)

D-C Plate Voltage	-	-	-	3000	4000	5000	6000	volts
D-C Grid Voltage	-	-	-	-500	-650	-800	-950	volts
D-C Plate Current	-	-	-	415	400	400	415	ma
D-C Grid Current*	-	-	-	55	60	55	60	ma
Peak R-F Grid Voltage	-	-	-	830	985	1150	1330	volts
Driving Power*	-	-	-	45	50	60	75	watts
Grid Dissipation*	-	-	-	15	15	16	20	watts
Plate Power Input	-	-	-	1250	1600	2000	2500	watts
Plate Power Output	-	-	-	750	1100	1500	2000	watts

*Approximate values

IF IT IS DESIRED TO OPERATE THIS TUBE UNDER CONDITIONS WIDELY DIFFERENT FROM THOSE GIVEN UNDER "TYPICAL OPERATION" POSSIBLY EXCEEDING THE MAXIMUM RATINGS GIVEN FOR CW SERVICE, WRITE EIMAC DIVISION OF VARIAN ASSOCIATES, FOR INFORMATION AND RECOMMENDATIONS



APPLICATION

MECHANICAL

Mounting—The 750TL must be mounted vertically, base down or up. The plate and grid leads should be flexible. The tube must be protected from vibration and shock.

Cooling—Heat Dissipating Connectors (Eimac HR-8 or equivalent) must be used at the plate and grid terminals of the 750TL. Unobstructed circulation of air around the tube is required in sufficient quantity to prevent the seal temperatures from exceeding 225° C. Forced ventilation of compartments or equipment in which the tube is located is usually desirable. Forced movement of air across the tube seals and envelope is always beneficial, though not necessarily required.

Tube temperatures may be measured with the aid of "Tempilaq", a temperature-sensitive lacquer manufactured by the Tempil Corporation, 132 West 22nd Street, New York 11, N. Y.

ELECTRICAL

Filament Voltage—For maximum tube life the filament voltage, as measured directly at the filament pins, should be the rated value of 7.5 volts. Variations should be kept within the range of 7.5 to 7.85 volts. All four socket terminals should be used, placing two in parallel for each filament connection.

Bias Voltage—Although there is no maximum limit placed on the bias voltage which may be used with the

750TL, there is little advantage in using bias voltages in excess of those given under "Typical Operation", except in certain very specialized applications.

When grid-leak bias is used, suitable protective means must be provided to prevent excessive plate dissipation in the event of loss of excitation, and the grid-leak resistor should be made adjustable to facilitate maintaining the bias voltage and plate current at the desired value from tube to tube.

Grid Dissipation—Grid dissipation may be calculated from the following expression:

$$P_g = e_{emp} I_c$$

where: P_g = Grid dissipation,
 e_{emp} = Peak positive grid voltage, and
 I_c = D-C grid current.

e_{emp} may be measured by means of a suitable peak voltmeter connected between filament and grid. In equipment in which the plate loading varies widely, such as oscillators used for radio-frequency heating, care should be taken to make certain that the grid dissipation does not exceed the maximum rating of 100 watts under any conditions of loading.

Plate Dissipation—Under normal operating conditions, the plate dissipation of the 750TL should not be allowed to exceed the maximum rating. Plate dissipation in excess of the maximum rating is permissible for short periods of time, such as during tuning procedures.

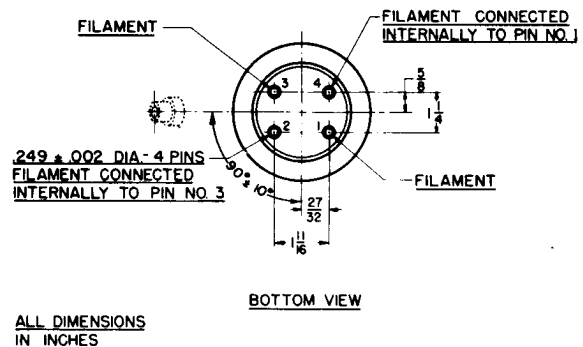
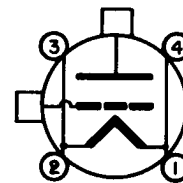
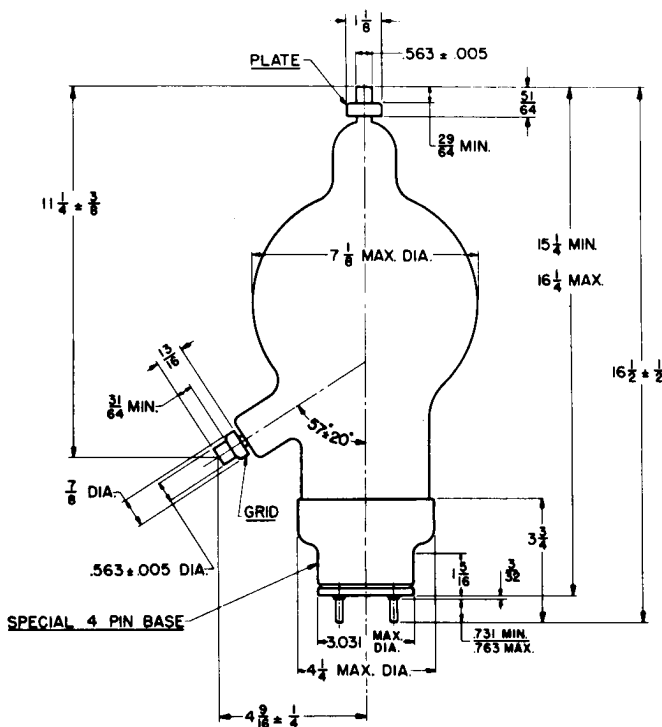

ALL DIMENSIONS IN INCHES

DRIVING POWER vs. POWER OUTPUT

The three charts on this page show the relationship of plate efficiency, power output and approximate grid driving power at plate voltages of 4000, 5000 and 6000 volts. These charts show combined grid and bias losses only. The driving power and power output figures do not include circuit losses. The plate dissipation in watts is indicated by P_p . Points A, B and C are identical to the typical Class-C operating conditions shown on the first page under 4000, 5000 and 6000 volts, respectively.

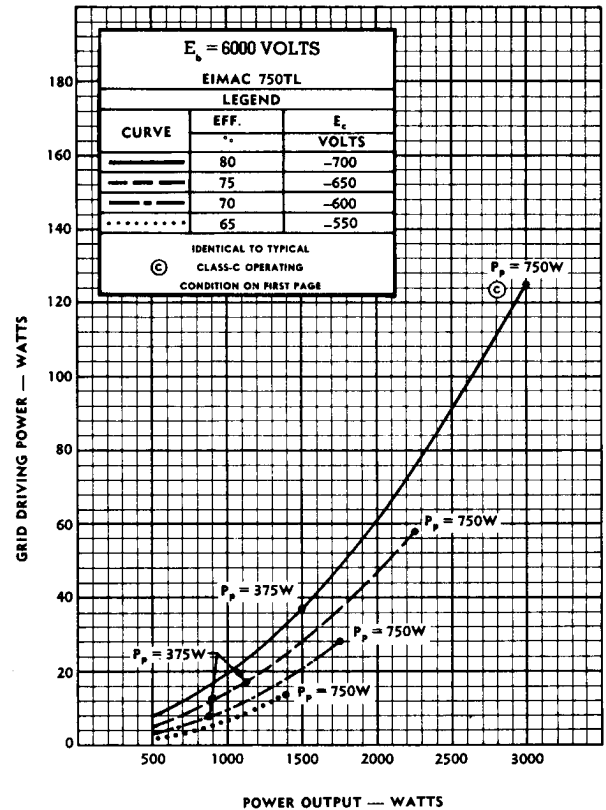
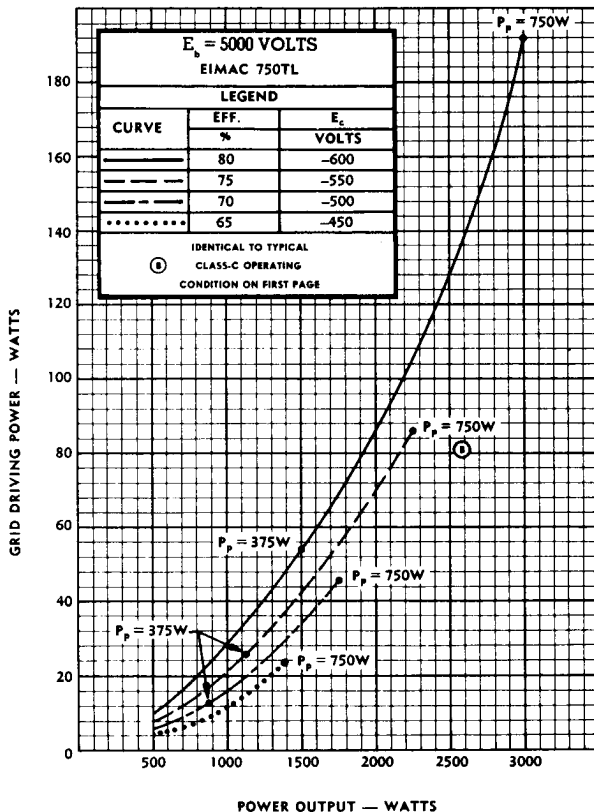
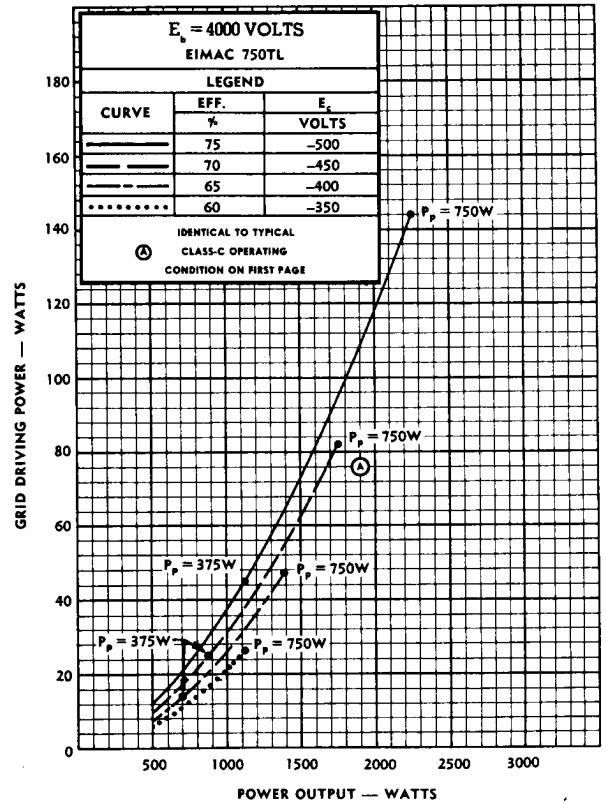



750TL

EIMAC 750TL

**TYPICAL
CONSTANT CURRENT
CHARACTERISTICS**

--- GRID CURRENT — AMPERES
— PLATE CURRENT — AMPERES

