

GAMMATRON TYPE 57

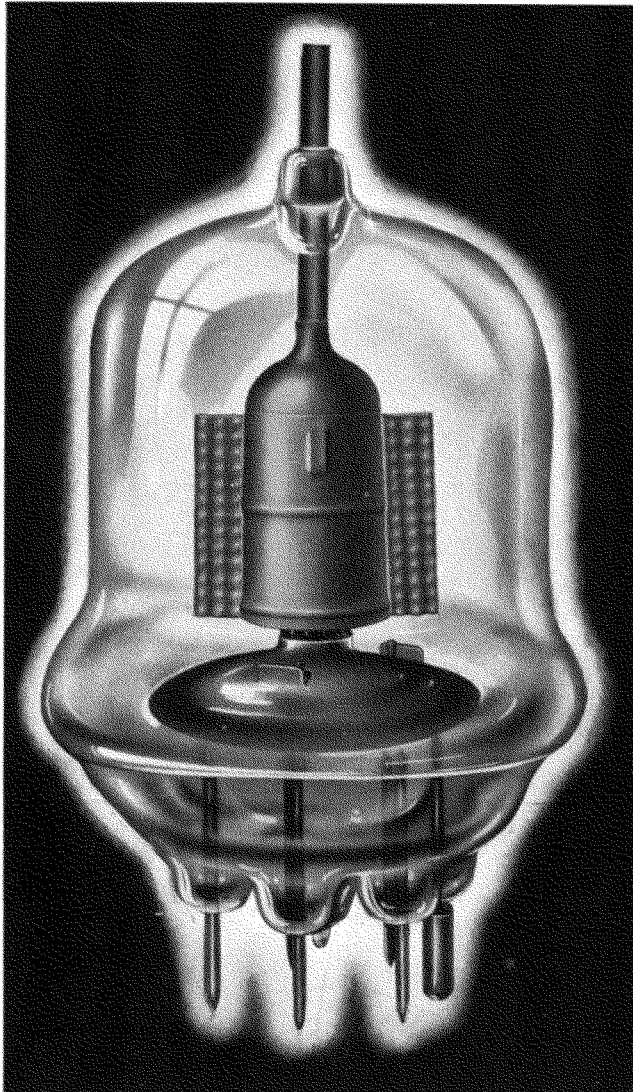

BEAM PENTODE

50 watt radiation cooled beam pentode. Exceptional very high frequency performance.

ELECTRICAL DATA

Plate Dissipation	50 Watts
Maximum Screen Input	25 Watts
Filament Voltage	5.0 Volts
Filament Current	5.0 Amps.

INTERELECTRODE CAPACITIES

Plate-Grid Capacity05 Mmfd.
Input Capacity	7.29 Mmfd.
Output Capacity	3.13 Mmfd.

PHYSICAL DATA

Plate	Enclosed Cylindrical Tantalum
Grids	Vertical Bar Tantalum
Filament	Thoriated Tungsten
Socket	Johnson #101 or #247
Envelope	Nonex Glass
Net Weight	2 $\frac{1}{4}$ Ounces
Shipping Weight	6 Ounces
Maximum Height	4 $\frac{1}{16}$ Inches
Maximum Diameter	2 $\frac{3}{8}$ Inches

The type HK-57 is capable of very high frequency operation and does not require neutralization. It has very low driving power requirements, will stand high plate and screen voltages, and will stand large momentary overloads. These features are made possible through the use of tantalum plate and grid elements and an advanced design by Heintz and Kaufman Ltd. engineers. The HK-57 is the only multi-element tube in its class capable of this kind of performance.

High mutual conductance in combination with high voltage capabilities makes the grid driving power requirements of the HK-57 very low. And under many conditions the power consumed is negligible. This feature reduces the number and size of the preliminary stages required in any transmitter resulting in savings and advantages that are obvious.

The plate and grid leads are short and sturdy, resulting in low lead inductance. The suppressor grid and screen grid are each supported with two parallel leads. All four leads are terminated on the base so that they may be individually bypassed to ground. The feed back capacity is extremely low and thus it is possible to operate the HK-57 even at very high frequencies without neutralization. This feature makes the HK-57 adaptable to instant band switching circuits and such circuits may be designed with a minimum of controls.

Installation into practical circuits is facilitated by the unique physical design of the HK-57. The input and output circuits are readily isolated and complete shielding is assured when the base shell is grounded.

TYPE HK-57

The information on this and the following page does not represent exact conditions of operation to be imposed for any particular situation. Because tubes are used under many widely different conditions Heintz and Kaufman will gladly furnish information for applications which differ appreciably from the illustrative examples given.

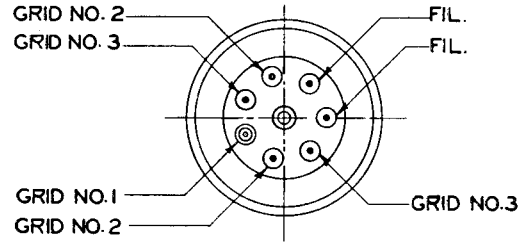
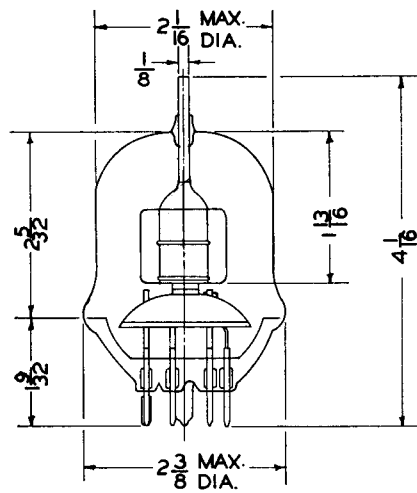

RADIO FREQUENCY POWER AMPLIFIER CLASS "C" UNMODULATED

	Maximum Rating Per Tube	TYPICAL OPERATION, 1 TUBE*				
		250	166	125	Watts	
Power Output18	.15	.14	Watts	
Driving Power		3000	2000	1500	Volts	
D.C. Plate Volts	3000	100	110	105	M. A.	
D.C. Plate Current	150	-0-	+30	+30	Volts	
D.C. Suppressor Voltage		-0-	1	4	M. A.	
D.C. Suppressor Current		500	450	450	Volts	
D.C. Screen Voltage	500	2	2	4	M. A.	
D.C. Screen Current	20	400	-175	-145	-145	Volts
D.C. Control Grid Voltage	400	1	1	1	M. A.	
D.C. Control Grid Current	15	195	160	160	Volts	
Peak R.F. Control Voltage		50†	50	32	Watts	
Plate Dissipation	50†	300	300	216	157	Watts
D.C. Plate Input	300					

*Other values to obtain similar results may be used provided the maximum ratings are not exceeded.
†Continuous rating. Intermittent rating 75 watts.

RADIO FREQUENCY POWER AMPLIFIER CLASS "C" PLATE MODULATED

(100% Modulation Peaks, 60% Average Value)

	Maximum Rating Per Tube	TYPICAL CARRIER CONDITIONS, 1 TUBE				
		200	135	125	Watts	
Power Output18	.2	.2	Watts	
Driving Power		2500	2000	1500	Volts	
D.C. Plate Volts	3000	96	88	105	M. A.	
D.C. Plate Current	135	-0-	+30	+30	Volts	
D.C. Suppressor Volts		-0-	3	4	M. A.	
D.C. Suppressor Current		500	450	450	Volts	
D.C. Screen Volts	500	2	2	4	M. A.	
D.C. Screen Current	20	400	-175	-145	-145	Volts
D.C. Control Grid Volts	400	1	1.5	1.5	M. A.	
D.C. Control Grid Current	15	190	165	165	Volts	
Peak R.F. Control Voltage		40	40	32	Watts	
Plate Dissipation	40	240	175	157	Watts	
D.C. Plate Input	250					

Gammatron Tubes

RADIO FREQUENCY POWER AMPLIFIER CLASS "C" SUPPRESSOR GRID MODULATED

TYPICAL CARRIER CONDITIONS, 1 TUBE

Power Output	90	50	23	Watts
Driving Power	0.6	0.3	0.2	Watts
Audio Power	100	140	121	Milliwatts
D.C. Plate Voltage	2000	1500	1000	Volts
D.C. Plate Current	80	58	40	M. A.
D.C. Suppressor Voltage	-190	-150	-120	Volts
D.C. Screen Voltage*	450	400	350	Volts
D.C. Screen Current	14	11	12	M. A.
Screen Series Resistor†	110,000	100,000	56,000	Ohms
D.C. Control Grid Voltage	-240	-210	-180	Volts
D.C. Control Grid Current	2.5	1.5	1.0	M. A.
Peak R.F. Driving Voltage	265	230	200	Volts
Peak A.F. Modulating Voltage	240	182	160	Volts
Plate Dissipation	50	25	17	Watts
Suppressor Circuit Resistance‡	300,000	120,000	100,000	Ohms
Modulation Percentage	94	95	94	%

*Screen voltage obtained from plate source through specified dropping resistor.

†Screen series resistor value specified provides the regulation required.

‡Load shown to modulator.

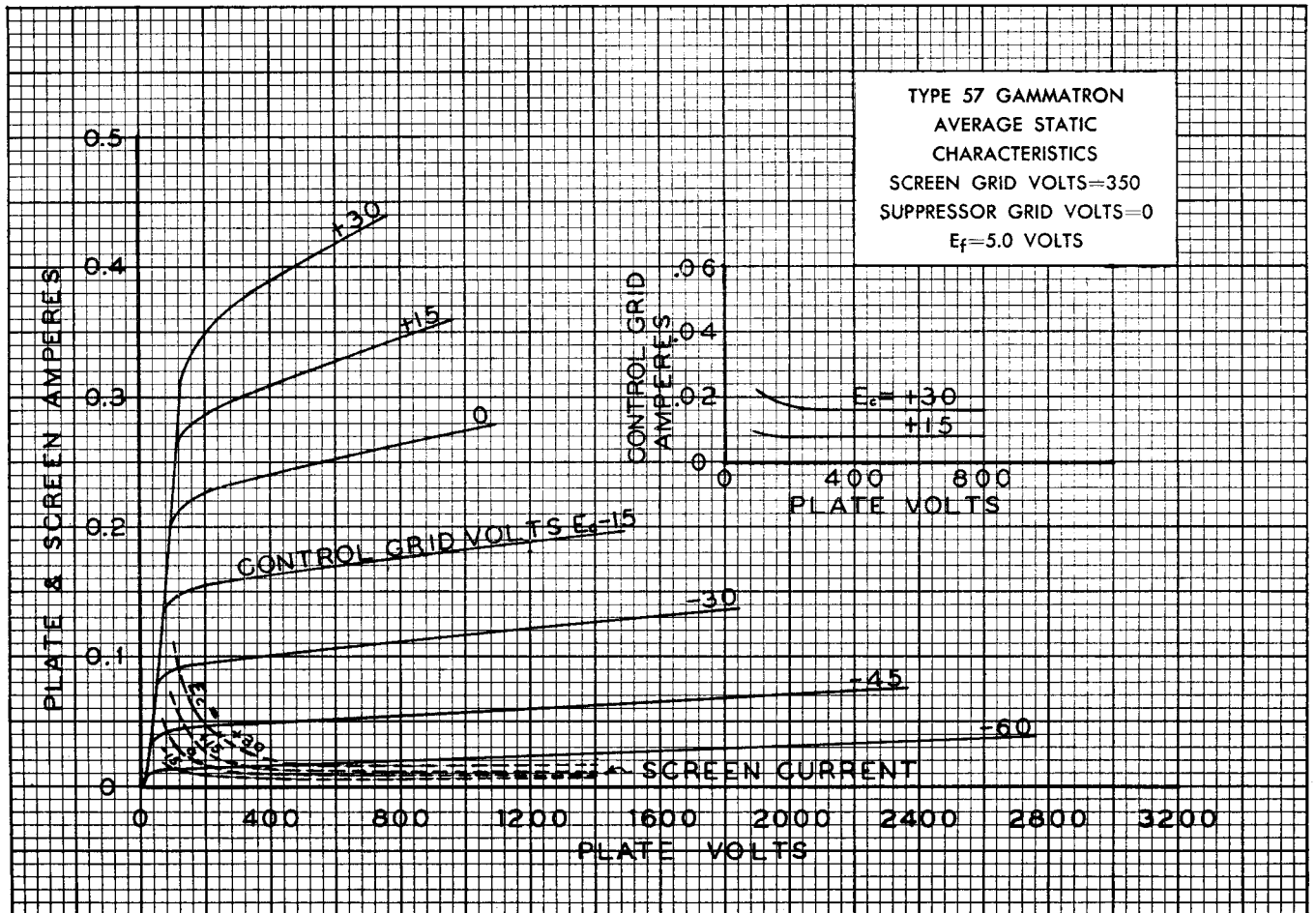

Gammatron Tubes

