

1940  
CATALOG  
and MANUAL

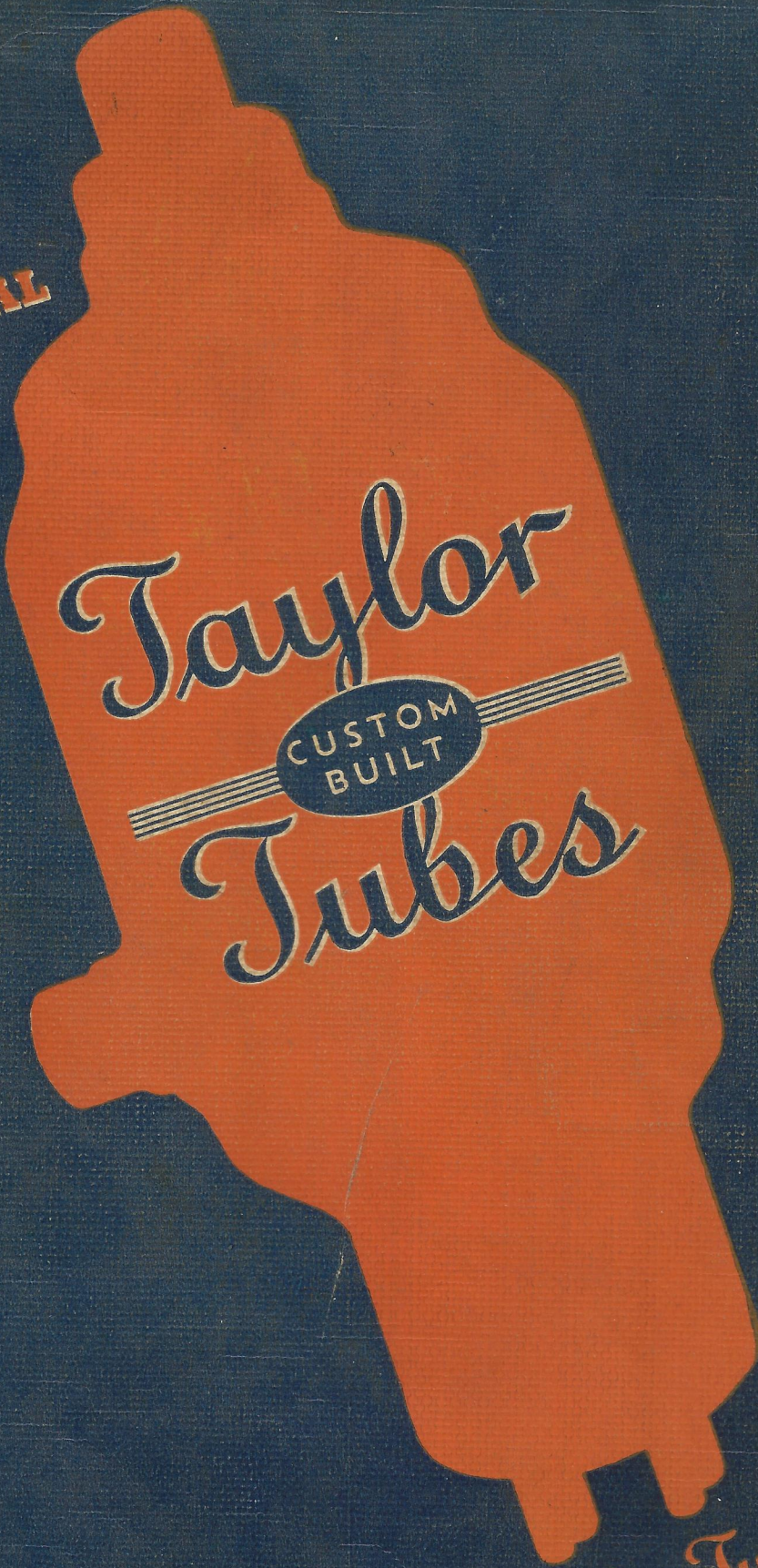

Taylor  
CUSTOM  
BUILT  
Tubes

Taylor Tubes, Inc.  
2341-43 WABANSIA AVENUE  
CHICAGO, ILLINOIS



## TAYLOR TUBES ARE SOLD THROUGH DISTRIBUTORS

There are TAYLOR TUBE Distributors in every logical distribution point throughout the U. S. and many foreign countries. We have attempted to see that all amateur and Broadcast Engineers could easily obtain TAYLOR TUBES when desired; and at the same time, tried to limit the distribution so that each Distributor would have a market large enough to afford carrying the complete line of TAYLOR TUBES.

All TAYLOR TUBE Distributors have been selected

with full consideration of their ability to serve and their reputation for fair dealing. We are extremely proud of the fact that Distributors not only sell TAYLOR TUBES—they RECOMMEND THEM above all others. We feel Radio Amateurs generally should recognize that the Radio Parts Distributors are their Best Friends—anxious at all times to extend the greatest possible cooperation on every transaction.

THERE IS A TAYLOR TUBE DISTRIBUTOR NEAR YOU.

## TAYLOR TUBE RATINGS HAVE F. C. C. APPROVAL

### INDEX

	Page		Page
General Information.....	1	814 Characteristics.....	18
TZ40 Characteristics.....	2	HD203A ".....	18
T40 ".....	3	841SW ".....	18
TW150 ".....	4	756 ".....	19
TW75 ".....	5	HD211C ".....	19
TZ20 ".....	6	HD203C ".....	19
T20 ".....	7	838 ".....	19
T21 ".....	8	825 ".....	19
T55 ".....	9	303C ".....	19
203Z ".....	10	TF100 ".....	19
805 ".....	11	866JR ".....	19
T200 ".....	12	830B ".....	19
T125 ".....	13	General Tube Information.....	20 to 27
203A ".....	14	Circuit Information.....	20 to 27
211 ".....	14	L/C Ratio Data.....	26
211C ".....	14	Transmitter Considerations.....	27
845 ".....	14	175 Watt Transmitter—T55.....	28, 29, 30, 31
822 ".....	15	Portable Transmitter.....	32
872A ".....	16	Safety KW Transmitter.....	33 to 37
875A ".....	16	275 DeLuxe Dual Unit Rig.....	38 to 45
249B ".....	17	TW75 Amplifier.....	46 to 47
866 ".....	17	Tube Comparison Chart.....	48
204A ".....	18		



# Taylor

HEAVY

CUSTOM  
BUILT

DUTY

# Tubes



**WARREN G. TAYLOR**  
President



**FRANK J. HAJEK—W9ECA**  
Sec. & Treas.



**JOSEPH F. HAJEK**  
Vice Pres.

## TAYLOR TUBES SETS THE PACE!

### 1940 MANUAL AND CATALOG

**1932**—The 825, a 25 watt Triode for \$4.95.

**1933**—A Quality 866 for \$1.65.  
(Competitive price was \$7.50.)  
756—Higher mu version of the 825.

**1934**—HD-203A—plate lead at top. Floating Anode at regular 203A price.

**1935**—822—A Super HD-203A capable of delivering over 500 watts of Audio in Class B.

**1936**—T-55 introduced and instantly became the Champion in its class.

**1937**—T-20 and TZ-20 made their bow and 20,000 were sold in the first year. 203Z announced.

**1938**—The Wonder Tubes T-40 and TZ-40 made their sensational appearance and set a new standard in Transmitting Tube Value.

**1939**—Shielded type 866 at new low price of \$1.50. Thin-wall Carbon Anode TW-150 brought out.

**1940**—TW-75 appears—with assurances of continued engineering and merchandising advances by the Leader—Taylor Tubes.

This list of achievements definitely proves that Taylor Tubes is living up to its policy of "More Watts per Dollar". In setting the pace, it is only natural that some of our Tubes will be copied—we expect that as it is one of the penalties of leadership. It is an easy thing to copy types and ideas but the hard thing is to equal Taylor Tubes Quality and back the products with the guarantee that Taylor Tubes extend. Among all Amateurs and Distributors, the Taylor reputation for fair, square dealing is an established fact and is one of the reasons why there are so many Taylor Tube Boosters. Your support makes this manual possible. Please accept our thanks.



**WM. T. BISHOP JR.**  
W9UI  
Engineer



**CHARLES KIDNER**  
Engineer



**REX L. MUNGER—W9LIP**  
Sales Manager



# Taylor



# Tubes

## TZ-40

ZERO BIAS TRIODE  
40 WATTS PLATE DISSIPATION  
The Wonder Tubes

### \$3.50

DELIVER 250 WATTS CLASS B AUDIO  
OUTPUT  
THE IDEAL DOUBLER TUBE

#### CLASS B AUDIO DATA

In the chart below, the current value is the maximum average value as would be indicated on the plate current meter with sine wave input. For the same peak output with voice input the maximum average plate current as indicated on meter will be approximately 50 to 60 per cent of this value.

Audio Watts Output ↓	750	1000	1250	1500	Supply Voltage ←
100	6000 230 ma. 4.0	15500 145 ma. 2.0			←Plate to Plate load ←Max. Av. Ip. ←Watts drive
150		8800 240 ma. 4.4	16000 175 ma. 2.75W		←Plate to Plate load ←Max. Av. Ip. ←Watts drive
175		7350 280 ma. 5.5	14000 200 ma. 3.4	20000 170 2.75	←Plate to Plate load ←Max. Av. Ip. ←Watts drive
225			10000 280 ma. 6.0	16000 215 3.85	←Plate to Plate load ←Max. Av. Ip. ←Watts drive
250				12000 250 ma. 6.0	←Plate to Plate load ←Max. Av. Ip. ←Watts drive

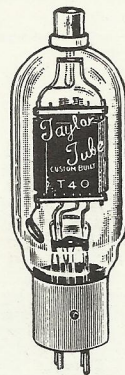
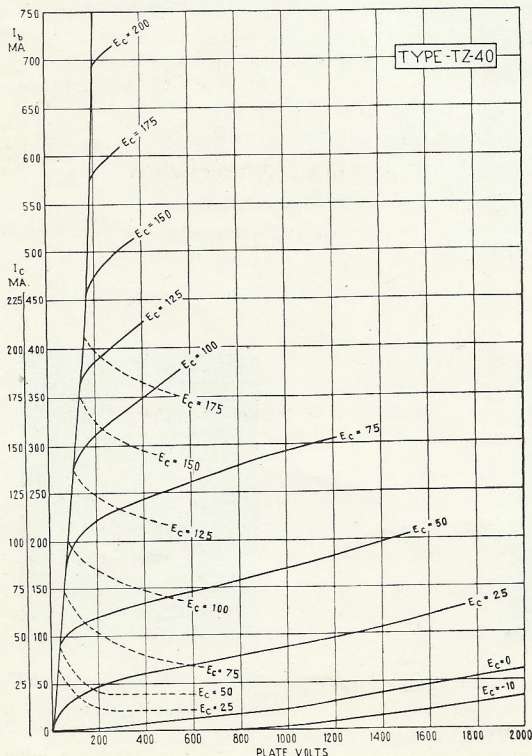

#### GENERAL CHARACTERISTICS

Filament Volts.....	7.5
Filament Current, amps.....	2.5
Amplification Factor.....	62
Plate Dissipation, watts.....	40

#### Interelectrode Capacities

Grid-Plate, mmf.....	5.0
Grid-Filament, mmf.....	4.8
Plate-Filament, mmf.....	0.8

#### Overall Dimensions

Maximum Length, inches.....	6¼
Maximum Diameter, inches.....	2¼
Alsimag	UX 4 Prong Base

#### CLASS C TELEGRAPHY, Maximum Ratings

	C.C.S.	I.C.A.S.
D. C. Plate Volts .....	1250	1500
D. C. Plate Current, ma.....	125	150
D. C. Grid Current, ma.....	45	45
D. C. Grid Volts .....	250	250
Plate Dissipation, watts.....	40	40*

#### Typical Operating Conditions

D. C. Plate Volts .....	1250	1500
D. C. Plate Current, ma.....	125	150
D. C. Grid Current, ma.....	31	38
D. C. Grid Bias Volts.....	-90	-90
From Grid Leak of, ohms.....	2900	2370
Plate Dissipation, watts.....	40	60*
Power Output, watts.....	116	165
Driving Power, watts.....	7.25	10

\* It is permissible to allow the plate dissipation to approach twice the normal rating in telegraph service where key down condition exists approximately 50 per cent of the time.

#### CLASS C TELEPHONY, Maximum Ratings

	C.C.S.	I.C.A.S.
D. C. Plate Volts .....	1000	1250
D. C. Plate Current, ma.....	115	125
D. C. Grid Current, ma.....	45	45
D. C. Grid Volts .....	250	250
Plate Dissipation, watts.....	30	40*

#### Typical Operating Conditions

D. C. Plate Volts .....	1000	1250
D. C. Plate Current, ma.....	100	125
D. C. Grid Current, ma.....	26	30
D. C. Grid Bias Volts.....	-65	-100
From Grid Leak of, ohms.....	2500	3300
Plate Dissipation, watts.....	27	40*
Power Output, watts.....	73	116
Driving Power, watts.....	4.6	7.5

\* The intermittent nature of voice modulation in amateur transmission permits the use of the maximum plate dissipation rating.

#### CLASS B AUDIO

##### Typical Operation Conditions for Two Tubes

	C.C.S.		I.C.A.S.	
D. C. Plate Volts .....	1250	1000	1500	1250
D. C. Plate Current, ma.....	240	200	250	280
D. C. Grid Bias Volts.....	-4.5	0	-9	-4.5
Power Output, watts.....	200	130	250	225*
Driving Power, watts.....	4.5	2.8	6	6
Plate to Plate Load, ohms.....	11000	11000	12000	10000
Peak Grid to Grid Volts.....	242	200	285	269

\* The intermittent nature and low average power in a voice wave permits use of higher peak power output without overloading the tubes. Power outputs listed are for sine wave voltage and are intended for use in calculating modulating capabilities. Actually the power output is much less with voice input.



# Taylor

**CUSTOM  
BUILT**

# Tubes

## T-40

**GENERAL PURPOSE TRIODE**  
**40 WATTS PLATE DISSIPATION**  
*The Wonder Tubes*

**\$3.50**

**260 WATTS Safety Factor**

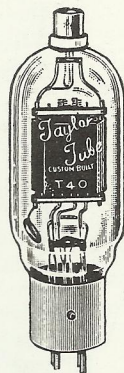

In two years nearly 25,000 T-40's and TZ-40's were put into operation in Amateur and Commercial Transmitters in nearly every country in the world. They are widely used by the British government. These Wonder Tubes are the most popular medium power Transmitting Tubes ever developed and they unquestionably set a new and higher standard of "Watts per Dollar" in this field. Prior to the advent of the T-40 and TZ-40, the only comparative tube sold for \$10.00, which is further proof that Taylor Tubes is solely responsible for today's outstanding values in Transmitting Tubes.

T-40's and TZ40's offer you Processed Carbon Anodes together with complete Molybdenum grids, making possible the Safest Tube in their class in their ability to withstand serious temporary overloads. The scientifically designed Thoriated Tungsten filaments insure long-life and maximum emission.

### TECHNICAL DATA

While the rated plate dissipation of the T-40 and TZ-40 is 40 watts no color shows on the plate until the dissipation amounts to approximately 60 watts and it takes about 90 watts to cause a red spot in the center of the plate. In this catalog it will be noticed that the TZ-40 has been recommended as an R.F. Amplifier. The reason is that due to the Zero Bias characteristics the plate current will drop to a low value when excitation ceases such as in keying of a preceding stage. This eliminates the necessity of a fixed source of bias as would be required by a T-40 under similar conditions. Comparing the T-40 and TZ-40 we note that the T-40 is easier to drive than the TZ-40. However, in most cases the small additional driving power required by the TZ-40 is less objectionable than the fixed source of bias that must be used with the T-40.

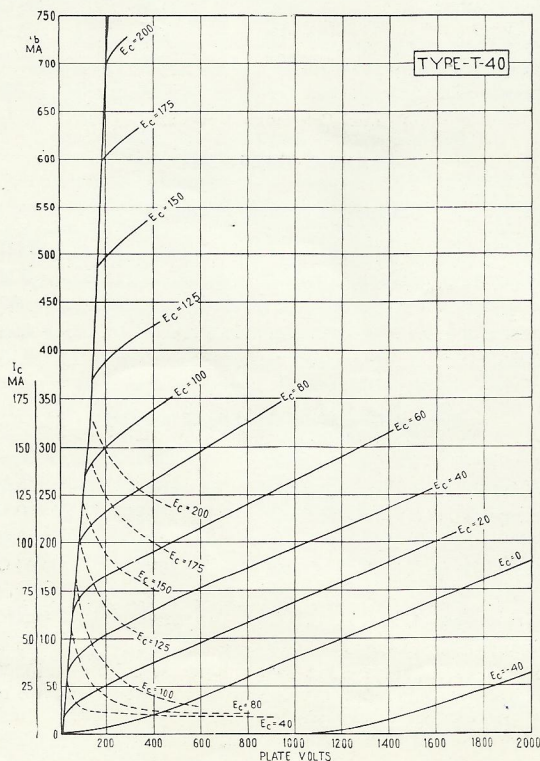

### GENERAL CHARACTERISTICS

Filament Volts .....	7.5
Filament Current, amps.....	2.5
Amplification Factor .....	25
Plate Dissipation, watts.....	40

### Interelectrode Capacities

Grid-Plate, mmf. ....	4.8
Grid-Filament, mmf. ....	4.5
Plate-Filament, mmf. ....	0.8

### Overall Dimensions

Maximum Length, inches.....	6 1/4
Maximum Diameter, inches.....	2 1/8

Alsimag

UX 4 Prong Base

### CLASS C TELEGRAPHY

#### Maximum Ratings

	C.C.S.	I.C.A.S.
D. C. Plate Volts.....	1250	1500
D. C. Plate Current, ma.....	125	150
D. C. Grid Current, ma.....	40	40
D. C. Grid Volts .....	250	250
Plate Dissipation, watts.....	40	40*

#### Typical Operating Conditions

D. C. Plate Volts.....	1250	1500
D. C. Plate Current, ma.....	125	150
D. C. Grid Current, ma.....	25	28
D. C. Grid Bias Volts.....	-110	-140
From Grid Leak of, ohms.....	4400	5000
Or { Fixed Supply of, volts.....	-60	-75
From { Plus Grid Leak of, ohms.....	2000	2300
Plate Dissipation, watts.....	40	67*
Power Output, watts.....	116	158
Driving Power, watts.....	6.5	9

\* It is permissible to allow the plate dissipation to approach twice the normal rating in telegraph service where key down condition exists approximately 50 per cent of the time.

### CLASS C TELEPHONY

#### Maximum Ratings

	C.C.S.	I.C.A.S.
D. C. Plate Volts.....	1000	1250
D. C. Plate Current, ma.....	115	125
D. C. Grid Current, ma.....	40	40
D. C. Grid Volts.....	250	250
Plate Dissipation, watts.....	30	40*

#### Typical Operating Conditions

D. C. Plate Volts.....	1000	1250
D. C. Plate Current, ma.....	100	115
D. C. Grid Current, ma.....	18	20
D. C. Grid Bias Volts.....	-100	-115
From Grid Leak of, ohms.....	5600	5750
Or { Fixed Supply of, volts.....	50	60
From { Plus Grid Leak of, ohms.....	2800	2750
Plate Dissipation, watts.....	29	40*
Power Output, watts.....	71	104
Driving Power, watts.....	4.2	5.25

\* The intermittent nature of voice modulation in amateur telephone transmission permits the use of the maximum plate dissipation ratings.



THE FIRST IN A NEW SERIES WITH



**OUTSTANDING FEATURES**

- **THIN-WALL CARBON ANODE**  
.015" thick. One-piece—machined from a solid block of carbon.
- **WARP-PROOF**  
Thin-Wall Carbon Anode retains its shape under any heat condition.
- **VISIBLE OPERATING TEMPERATURE**  
Operates at cherry red heat at rated plate dissipation.
- **PUNCTURE-PROOF**  
New scientific grid structure guarantees against punctures due to heating of glass.
- **ENCLOSED ANODE**  
Affords complete "Electron Control" assuring added efficiency.

**WILL STAND TEMPORARY OVERLOADS UP TO 800%**

The TW-150 is a triode with a relatively high mu embodying a carbon plate of a revolutionary new design only 0.015 inches thick. The use of carbon makes it possible to use a smaller plate, thus reducing the inter-electrode capacitances. An ideal tube for U. H. F. applications. It can be operated at full ratings on frequencies as high as 60 mc. The grid supports are designed to prevent insulation break-down when operating in high bias, high efficiency circuits.

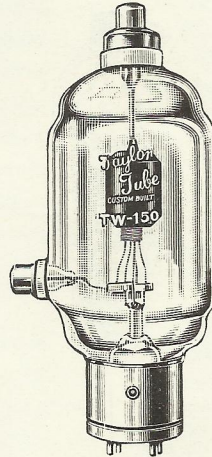

## TW-150

150 WATTS PLATE DISSIPATION

**CHARACTERISTICS**

Filament Volts*	10.0
Filament Amperes*	4.1
Amplification Factor	35
*Obtainable on special order with 5.0 volt—8.2 Amp. Filament on UX 4-prong base.	

**Interelectrode Capacities**

Grid-Plate	2.0 MMF.
Grid-Filament	3.9 MMF.
Plate-Filament	0.8 MMF.
<b>NONEX GLASS</b>	<b>50 WATT TYPE BASE</b>

**\$15.00**

**TW-150 RATINGS**

**CLASS C TELEGRAPH**

**Maximum Ratings**

D. C. Plate Voltage	3000 Volts
D. C. Plate Current	200 Ma.
D. C. Grid Current	60 Ma.
D. C. Grid Voltage	—600 Volts
Plate Dissipation	150 Watts

**Typical Operating Conditions**

D. C. Plate Voltage	2000	2500	3000 Volts
D. C. Plate Current	200	200	200 Ma.
D. C. Grid Current	46	45	45 Ma.
D. C. Grid Voltage	—90	—120	—170 Volts
From Grid Leak of	1950	2670	3780 Ohms*
Plate Dissipation	110	130	130 Watts
Power Output	290	370	470 Watts
Driving Power	13	14	17 Watts

**CLASS C TELEPHONY**

**Maximum Ratings (carrier)**

D. C. Plate Voltage	3000 Volts
D. C. Plate Current	200 Ma.
D. C. Grid Current	60 Ma.
D. C. Grid Voltage	—600 Volts
Plate Dissipation	110 Watts

**Typical Operating Conditions (carrier)**

D. C. Plate Voltage	2000	2500	3000 Volts
D. C. Plate Current	200	185	165 Ma.
D. C. Grid Current	46	44	40 Ma.
D. C. Grid Voltage	—140	—200	—260 Volts
From Grid Leak of	3040	4550	6000 Ohms*
Or Fixed Supply of	—60	—75	—90 Volts
From Grid Leak of	1740	2840	4250 Ohms*
Plate Dissipation	105	102	95 Watts
Power Output	295	360	400 Watts
Driving Power	16	17	17 Watts

\*Nearest stock resistor value can be used.

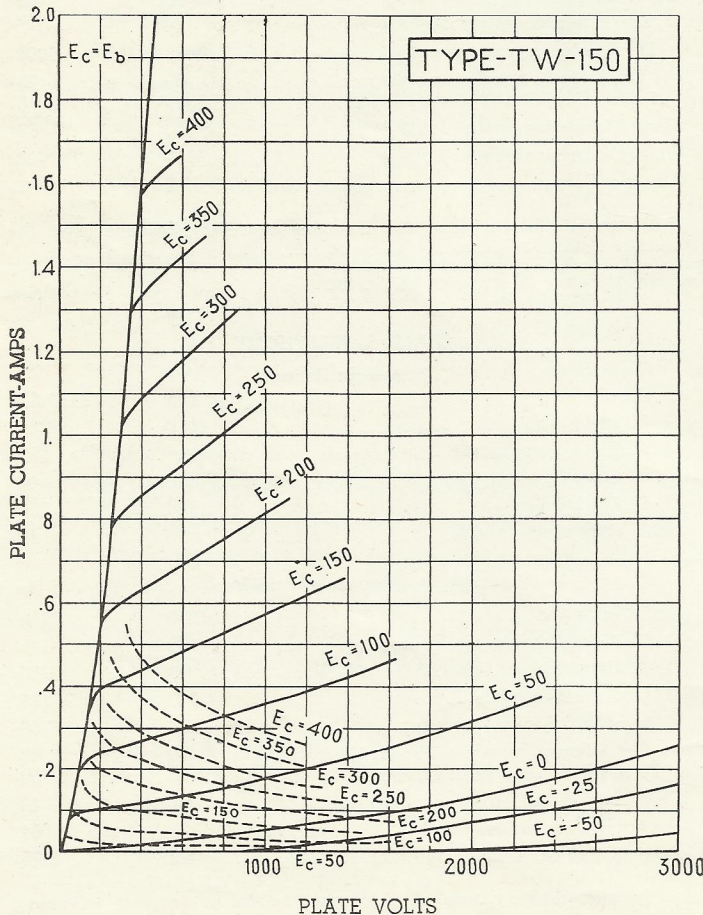



# Taylor

**CUSTOM  
BUILT**

# Tubes

## TW-75

**75 WATTS PLATE DISSIPATION  
THE SECOND IN A SERIES WITH**



**\$8.00**

**SAFETY FACTOR 525 WATTS**

### OUTSTANDING FEATURES

- **THIN-WALL CARBON ANODE**  
.015" thick. One-piece—machined from a solid block of carbon.
- **WARP-PROOF**  
Thin-Wall Carbon Anode retains its shape under any heat condition.
- **VISIBLE OPERATING TEMPERATURE**  
Operates at cherry red heat at rated plate dissipation.
- **PUNCTURE-PROOF**  
New scientific grid structure guarantees against punctures due to heating of glass.
- **ENCLOSED ANODE**  
Affords complete "Electron Control" assuring added efficiency.  
**WILL STAND TEMPORARY OVERLOADS UP TO 800%**

The TW-75 is a Triode embodying a carbon plate of revolutionary design only 0.015 inches thick. It's compact size will prove of great advantage in the design of Transmitters making it ideal for all U.H.F. applications. It can be operated at full ratings on frequencies as high as 60 mc.

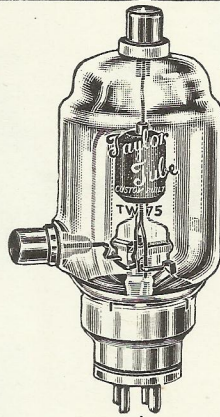

### GENERAL CHARACTERISTICS

Filament Volts .....	7.5
Filament Current, amps.....	4.15
Amplification Factor .....	20
Plate Dissipation, watts.....	75

### Interelectrode Capacities

Grid-plate, mmf. ....	1.5
Grid-filament, mmf. ....	3.35
Plate-filament, mmf. ....	.7

### Overall Dimensions

Maximum length, inches.....	6 1/4
Maximum diameter, inches.....	3 1/4
<b>Nonex Glass</b>	<b>UX 4 Prong Base</b>

### CLASS C TELEGRAPHY

#### Maximum Ratings

D. C. Plate Volts.....	2000
D. C. Plate Current, ma.....	175
D. C. Grid Current, ma.....	60
D. C. Grid Volts.....	500
Plate Dissipation, watts.....	75

#### Typical Operating Conditions

D. C. Plate Volts.....	1000	1500	2000
D. C. Plate Current, ma.....	175	165	150
D. C. Grid Current, ma.....	45	42	37
D. C. Grid Bias Volts.....	-135	-157	-175
From grid leak of, ohms.....	3000	3750	4750
Or { Fixed Supply of, Volts.....	50	75	100
From { Plus Grid Leak of, ohms.....	1900	1950	2000
Plate Dissipation, watts.....	62	71	75
Power Output, watts.....	113	177	225
Driving Power, watts.....	15	14.2	12.7

### CLASS C TELEPHONY

#### Maximum Ratings

D. C. Plate Volts.....	2000
D. C. Plate Current, ma.....	150
D. C. Grid Current, ma.....	60
D. C. Grid Volts.....	500
Plate Dissipation, watts.....	50

#### Typical Operating Conditions

D. C. Plate Volts.....	1000	1500	2000
D. C. Plate Current, ma.....	150	135	125
D. C. Grid Current, ma.....	40	32	32
D. C. Grid Bias Volts.....	-175	-230	-260
From Grid Leak of, ohms.....	5500	6500	8000
Or { Fixed Supply of, volts.....	50	75	100
From { Plus Grid Leak of, ohms.....	4400	4400	5000
Plate Dissipation, watts.....	47	47	52
Power Output, watts.....	103	141	198
Driving Power, watts.....	14	12.7	13.2

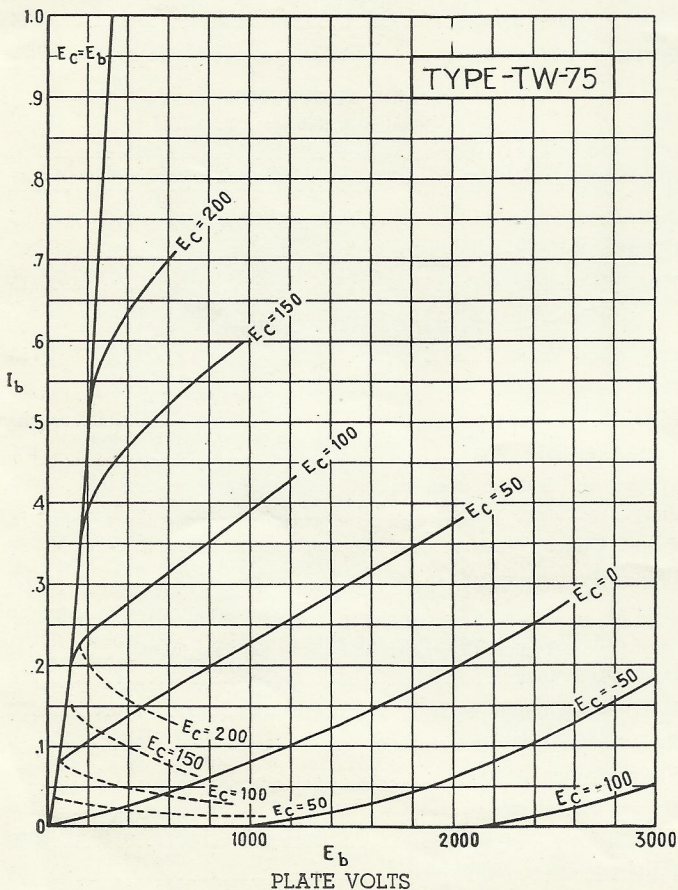



# Taylor



# Tubes

## TZ-20

ZERO BIAS TRIODE

20 WATTS PLATE DISSIPATION

**\$2.25**

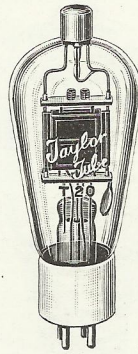

### GENERAL CHARACTERISTICS

Filament Volts .....	7.5
Filament Current, amps.....	1.75
Amplification Factor .....	62
Plate Dissipation, watts.....	20

### Interelectrode Capacities

Grid-plate, mmf .....	4.95
Grid-filament, mmf .....	5.25
Plate Filament, mmf.....	.55

### Overall Dimensions

Maximum length, inches.....	6
Maximum diameter, inches.....	2 3/8

UX 4-Prong Alsimag Base

The TZ20 is primarily designed for zero bias Class B audio operation and no bias is required for such operation at voltages up to 800. It is the Ideal Class B audio tube for outputs up to 80 watts and 4 of them push pull parallel will form a most economical 160 watt modulator. For pushpull parallel operation the reflected load impedance will be half and the output twice that for two tubes. The Class B operating conditions for the T20 and TZ20 are identical but the TZ20 avoid the necessity for a source of grid bias with good voltage regulation. At 800 volts the no-signal plate current to a pair of TZ20's will be approximately 25 to 30MA.

The chart below gives proper Class B Audio operating conditions for various outputs at different plate voltages. The most important value is the reflected load impedance which is given for the entire primary or plate to plate. The current value is the maximum average value as would be indicated on the plate current meter with sine wave input. For the same peak output with voice input the maximum average plate current will be approximately 50% to 60% of this value. The TZ20 requires no bias voltage.

D.C. Plate Voltage ↓	40	50	60	70	←Audio Watts Output
800	78MA 21,000	98MA 17,000	117MA 14,000	137MA 12,000	←Max. Av. Ip. ←Plate to plate Load
700	92MA 15,000	115MA 12,000	140MA 10,000		←Max. Av. Ip. ←Plate to plate load
600	113MA 10,200	140MA 8,100			←Max. Av. Ip. ←Plate to plate load

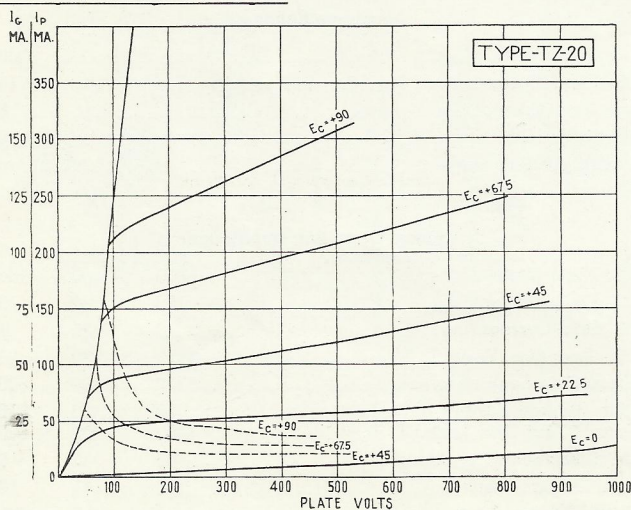

### CLASS C TELEGRAPHY

#### Maximum Ratings

D. C. Plate Volts .....	750
D. C. Plate Current, ma.....	85
D. C. Grid Current, ma.....	30
D. C. Grid Volts .....	200
Plate Dissipation, watts.....	20

#### Typical Operating Conditions

D. C. Plate Volts .....	750
D. C. Plate Current, ma.....	85
D. C. Grid Current, ma.....	28
D. C. Grid Bias Volts.....	-40
From grid leak of, ohms.....	1500
Plate Dissipation, watts.....	20
Power Output, watts.....	44
Driving Power, watts.....	3.75

### CLASS C TELEPHONY

#### Maximum Ratings

D. C. Plate Volts .....	750
D. C. Plate current, ma.....	75
D. C. Grid current, ma.....	30
D. C. Grid Volts .....	200
Plate Dissipation, watts.....	15

#### Typical Operating Conditions

D. C. Plate Volts .....	750
D. C. Plate current, ma.....	70
D. C. Grid current, ma.....	23
D. C. Grid Bias Volts.....	-100
From grid leak of, ohms.....	4500
Plate Dissipation, watts.....	15
Power Output, watts.....	38
Driving Power, watts.....	4.8

### CLASS B AUDIO

#### Typical Operating Conditions (for two tubes)

D. C. Plate Volts .....	750
D. C. Plate Current, ma.....	170
D. C. Grid Bias Volts.....	0
Power Output, watts.....	80
Driving Power, watts.....	2.6
Plate to Plate load, ohms.....	9000
Peak A.F. Grid to Grid Volts.....	195



# Taylor

**CUSTOM  
BUILT**

# Tubes

## T-20

GENERAL PURPOSE TRIODE

20 WATTS PLATE DISSIPATION

**\$2.25**

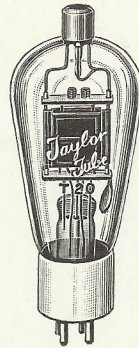

The T20 is recommended as an extremely fine amplifier tube on all frequencies up to 60 MC. Nearly 30,000 T20's and TZ20's combined have been bought by Amateurs throughout the world and daily we receive enthusiastic reports of long life and highly efficient performance. T20's and TZ20's require a minimum amount of excitation and their ratings are conservative. While the rated plate dissipation is 20 watts, no color shows on the plate until the dissipation amounts to approximately 32 watts and it takes about 45 watts to cause a cherry red spot in the center of the plate.

**CAUTION:** Taylor T20's and TZ20's have nickel plates and due to the much lower temperature at which this material will melt, they do not have the same high standard of SAFETY FACTOR that is a feature of Taylor Tubes using carbon anodes. The **Safety Factor** of T20's and TZ20's is approximately 80 watts. This does not mean that they will be any less efficient but it does mean they will not stand as much abuse. The plate voltage should be reduced while making adjustments to prevent excessive heating. Properly handled, the efficiency of these tubes will be as great as though they had carbon anodes and their life will be equally as long.

### GENERAL CHARACTERISTICS

Filament Volts .....	7.5
Filament Current, amps.....	1.75
Amplification Factor .....	20
Plate Dissipation, watts.....	20

### Interelectrode Capacities

Grid-plate, mmf .....	5.05
Grid-filament, mmf .....	4.85
Plate-filament, mmf.....	0.65

### Overall Dimensions

Maximum length, inches.....	6
Maximum diameter, inches.....	2 3/8

UX 4-prong Alsimag Base

### CLASS C TELEGRAPHY Maximum Ratings

D. C. Plate Volts .....	750
D. C. Plate Current, ma.....	85
D. C. Grid Current, ma.....	25
D. C. Grid Volts .....	200
Plate Dissipation, watts.....	20

### Typical Operating Conditions

D. C. Plate Volts .....	750
D. C. Plate Current, ma.....	85
D. C. Grid Current, ma.....	18
D. C. Grid Bias Volts.....	-85
From grid leak of, ohms.....	4722
Or { Fixed supply of, volts.....	40
From { Plus grid leak of, ohms.....	2500
Plate Dissipation, watts.....	20
Power Output, watts.....	44
Driving Power, watts.....	3.6

### CLASS C TELEPHONY Maximum Ratings

D. C. Plate Volts .....	750
D. C. Plate Current, ma.....	75
D. C. Grid Current, ma.....	25
D. C. Grid Volts .....	200
Plate Dissipation, watts.....	15

### Typical Operating Conditions

D. C. Plate Volts .....	750
D. C. Plate Current, ma.....	70
D. C. Grid Current, ma.....	15
D. C. Grid Bias Volts.....	-135
From grid leak of, ohms.....	9000
Or { Fixed supply of, volts.....	40
From { Plus grid leak of, ohms.....	6350
Plate Dissipation, watts.....	15
Power Output, watts.....	38
Driving Power, watts.....	3.6

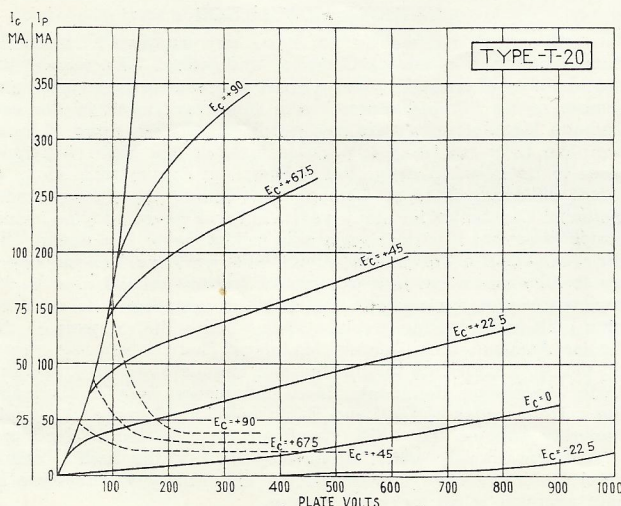



# Taylor

CUSTOM  
BUILT

# Tubes

## T-21

21 WATTS

PLATE DISSIPATION

BEAM TUBE

**\$1.95**

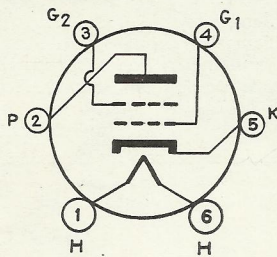

T-21

Bottom View



## What About Ratings?

Recently there was brought forth a new type of Ratings which allowed for the difference that actually existed between two classes of use—Continuous Commercial Service and Interrupted or Intermittent Commercial and Amateur Service. Taylor Tubes agrees that these Dual ratings are theoretically correct and have met these competitive ratings on a few types. In every case our filaments were capable of meeting any emission demands required by the new I.C.A.S. ratings with long tube life kept constantly in mind. In addition, due to the use of Processed Carbon Anodes, Taylor Tubes offer a high standard of SAFETY FACTOR. We define Safety Factor as the ability of a Tube to withstand serious temporary overloads without injury to the elements. In the case of the T-40, as an example, every

tube is factory tested at 300 watts Plate Dissipation. The rated plate dissipation is 40 watts, making your SAFETY FACTOR 260 watts. Now if any tube in the T-40 class using a nickel Anode is rated at 55 watts plate dissipation and the nickel anode will melt at 150 watts, your Safety Factor would be only 95 watts. The extremely high melting point of the Taylor Carbon Anodes is 3527° C as against 1452° C for a Nickel Anode, 2620° C for Molybdenum and 2850° for Tantalum.

The Taylor margin of extra safety is of vital importance, as many tubes are ruined in tuning up amplifiers. (When a stage goes out of resonance, the plate current soars, resulting in plate dissipation far in excess of the Tube's normal rated dissipation.) High Safety Factor Standards are provided for in all Taylor Carbon Anode Tubes. Referring to the T-40 type again, we point out as one of its many reasons for holding Sales Leadership is the fact that it should be and is better because it costs more to make it. A Nickel Anode Tube, in this same price class, costs about 35c less to produce. The extra costs that are put into Taylor Tubes accrue to your benefit many times—in performance—in tube life—in Safety Factor—and in the Broadest Guarantee in the Business.

The T-21 is a heater cathode type Beam Power Amplifier Tube especially efficient as an oscillator, amplifier or frequency multiplier and desirable for mobile and portable radio transmitters. The electrical characteristics are similar to those of the 6L6G.

### GENERAL CHARACTERISTICS

Heater Voltage, volts.....	6.3
Heater Current, amps.....	0.9
Amp. Factor.....	138
Max. Plate Dissipation, watts.....	21
Max. Screen Dissipation, watts.....	3.5

### Overall Dimensions

Max. Length, inches.....	5 5/8
Max. Diameter, inches.....	2 1/8

### Interelectrode Capacities

Grid to Plate, mmf.....	1.4
Input, mmf.....	11.5
Output, mmf.....	11.5

### CLASS C AMPLIFIER

Max. Operating Plate, volts.....	400*
Max. D. C. Plate Current—Telegraph, ma.....	95
Max. D. C. Plate Current—Telephone, ma.....	65
Max. D. C. Grid Current, ma.....	5
D. C. Grid, volts.....	-45
Max. Driving Power, watts.....	.4
Max. Screen Current, ma.....	16
Max. Screen Voltage.....	300

\* It is recommended that plate voltage be reduced to 300 volts at frequencies above 30 MC.

### WHAT ABOUT GAS?

All known materials, usable as Anodes, have a heat point at which all gases will be expelled. In degassing a tube, tremendous heat is induced into the Anodes by the Radio Frequency currents while a series of vacuum pumps of special design carry away the gases being liberated. (It is interesting here to note that carbon has the highest melting point of all common anode materials—see list in copy above.) Regardless of the Anode material used, this process of degassing is always followed. A TUBE MADE "GAS-FREE" IN PRODUCTION REMAINS "GAS-FREE." Processed Carbon Anodes have ideal degassing qualities and compare, in this respect, more than favorably with all other anode materials.

Carbon Anodes, in addition, due to their rough black surfaces, radiate heat many times faster than metal anodes with smooth and shiny surfaces.

### CATHODE MODULATION

You will notice that we do not have any suggested Transmitter circuits showing the use of Cathode Modulation. We respect the technical ability of Frank C. Jones a great deal and have recommended a number of his "Brain-Children" with fine results, but in the case of Cathode Modulation, we are not in full accord with some of Jones' views. We have not found it possible to attain the high efficiencies claimed to be possible using this system.—in our opinion 45 to 50 per cent efficiency is tops. Cathode Modulation was known among Commercial Companies for many years, but was never adopted, which indicates to us that it is not comparable to high level modulation. We never recommend a Transmitter circuit until we have had the opportunity to fully test it out in a Completed Transmitter and, due to this policy, we cannot comply with the requests we receive to send out circuits built around some combination of Tubes that appeals to that particular Amateur. For Cathode Modulated Transmitters, we recommend that you follow the information and circuits given in Jones' fine Cathode Modulation Handbook. More information is also obtainable in the current issues of QST and Radio and for all types of Circuits we heartily endorse the ARRL Handbook and the Radio Handbook. We, of course, closely watch all developments in the Radio Communication Field and always welcome the opportunity to cooperate by prompt attention to all technical queries.

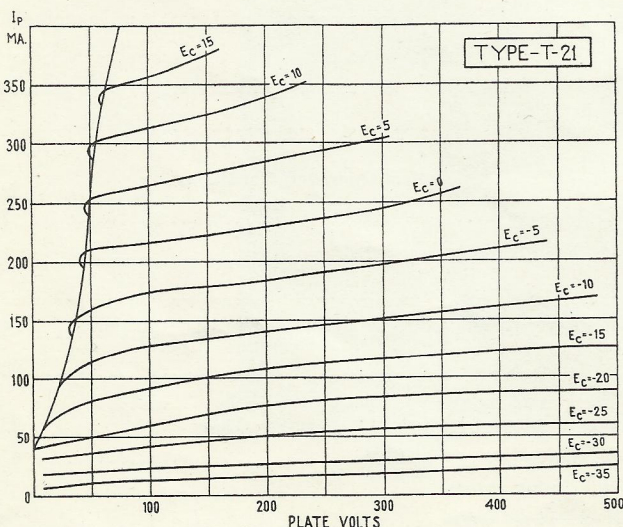



# Taylor

**CUSTOM  
BUILT**

# Tubes

## T-55

**55 WATTS PLATE DISSIPATION  
AMATEUR'S FAVORITE TUBE  
OVER 13,000 IN USE**

Improved

**\$6.00**

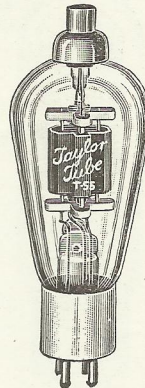

### GENERAL CHARACTERISTICS

Filament Volts .....	7.5
Filament Current, amps.....	3.0
Plate Dissipation, watts.....	55
Amp. Factor .....	20

### Overall Dimensions

Maximum Length, inches.....	7
Maximum Diameter, inches.....	2 5/8

### Interelectrode Capacities

Grid-Plate, mmf. ....	3.85
Grid-Filament, mmf. ....	4.95
Plate-Filament, mmf. ....	1.15
<b>Nonex Glass</b> .....	<b>UX 4 Prong Base</b>

The TAYLOR T-55 is a tube of medium power capable of efficient power output at frequencies as high as 60 Megacycles, yet it operates at reasonable values of plate voltage and plate current. Its medium low interelectrode capacities and efficient flat form of construction result in low losses across the elements avoiding the necessity for high voltages for good efficiency and reducing the grid drive requirements. The T-55 will give more power output for a given amount of grid drive than any other high frequency tube of the same comparative class. The design of this tube permits use of ceramic internal insulators. The misalignment of elements (which so often develop in tubes with self-supporting elements) is impossible in the T-55.

Although there are competitive tubes available whose ratings approach the T-55 ratings at lower prices, we emphasize the fact that the T-55 has far greater value because of superior quality. This quality is made possible by use of a Processed Carbon Anode, all-Tungsten leads and Nonex Glass. The T-55 has a safety factor of 345 watts. Taylor's T-55 is the standard 55 watt tube throughout the world, just as the 203-A is standard in its class.

### CLASS C TELEGRAPHY

#### Maximum Ratings

	C.C.S.	I.C.A.S.
D. C. Plate Volts.....	1500	1500
D. C. Plate Current, ma.....	135	165
D. C. Grid Current, ma.....	30	40
D. C. Grid Volts.....	350	
Plate Dissipation, watts.....	55*	55*

#### Typical Operating Conditions

	C.C.S.	I.C.A.S.
D. C. Plate Volts.....	1500	1500
D. C. Plate Current, ma.....	135	165
D. C. Grid Current, ma.....	16	20
D. C. Grid Bias Volts.....	-130	-140
From Grid Leak of, ohms.....	8000	7000
Plate Dissipation, watts.....	49	64.5*
Power Output, watts.....	153	183.5
Driving Power, watts .....	4	5.6
Peak AC Grid Volts.....	280	315

\* It is permissible to allow the plate dissipation to approach twice the normal value when key down condition exists approximately half the time.

### CLASS C TELEPHONY

#### Maximum Ratings

	C.C.S.	I.C.A.S.
D. C. Plate Volts.....	1250	1500
D. C. Plate Current, ma.....	120	135
D. C. Grid Current, ma.....	30	30
Plate Dissipation, watts.....	37	55#

#### Typical Operating Conditions

	C.C.S.	I.C.A.S.
D. C. Plate Volts.....	1000	1250
D. C. Plate Current, ma.....	100	120
D. C. Grid Current, ma.....	13	15
D. C. Grid Bias Volts.....	-150	-160
From Grid Leak of ohms.....	10000	10000
Or { Fixed Supply of, volts....	-50	-65
From { Plus Grid Leak of, ohms..	6500	6000
Plate Dissipation, watts.....	25	36
Power Output, watts.....	75	114
Driving Power, watts.....	3.4	4.2
Peak AC Grid Volts.....	290	310
		345
		375

# The intermittent nature of voice modulation permits the use of the full plate dissipation rating of the tube.

**C.C.S.** ratings are for Continuous Commercial Service.  
**I.C.A.S.** ratings are for Intermittent Commercial and Amateur Service.

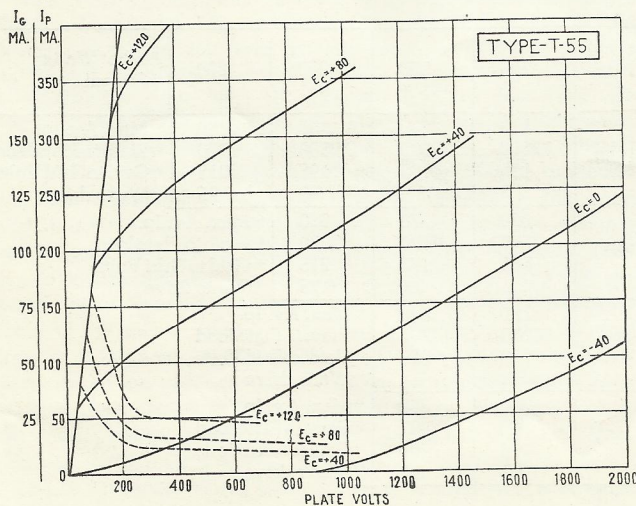



# Taylor



# Tubes

## 203-Z

ZERO BIAS TUBE

65 WATTS PLATE DISSIPATION

Nickel Anode

**\$8.00**

300 WATTS CLASS B OUTPUT

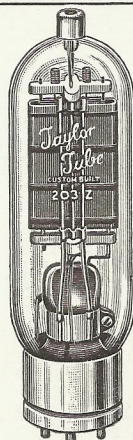

### GENERAL CHARACTERISTICS

Filament Volts .....	10
Filament Current, amps.....	3.25
Amplification Factor .....	85
Plate Dissipation, watts.....	65

### Overall Dimensions

Maximum Length, inches.....	8 1/4
Maximum Diameter, inches.....	2 5/8
50 Watt Base	Nonex Glass

### CLASS B AUDIO

#### Maximum Ratings

D. C. Plate Volts .....	1250
D. C. Plate Current, ma.....	175
Plate Dissipation, watts.....	65

#### Typical Operating Conditions for Two Tubes

D. C. Plate Volts .....	1000	1250
D. C. Plate Current, ma. (max. signal).....	350	350
D. C. Plate Current, ma. (zero signal).....	60	50
D. C. Grid Bias Volts.....	0	-4.5
Power Output, watts.....	230	300
Driving Power, watts.....	6.5	6.75
Peak Grid to Grid, volts.....	206	215
Plate to Plate Load, ohms.....	6200	8000

### CLASS B AUDIO DATA

The chart below gives the maximum average value as would be indicated on the plate current meter with sine wave input. For the same peak output with voice input the maximum average plate current will be approximately 50 to 60 per cent of this value.

Supply Voltage	150	200	250	300	Audio Watts ←Output
1250	170	230	300	350	←Max. Av. Ip. ←Plate to Plate load ←Grid to Grid Volts ←Watts drive
	17500	12500	9500	8000	
	135	165	195	215	
	2.5	3.9	5.6	6.75	
1100	200	270	350	350	←Max. Av. Ip. ←Plate to Plate load ←Grid to Grid Volts ←Watts drive
	12700	9000	7000	7000	
	149	183	215	215	
	3.1	5.0	6.75	6.75	
1000	220	320	350	350	←Max. Av. Ip. ←Plate to Plate load ←Grid to Grid Volts ←Watts drive
	10000	6900	7000	7000	
	150	203	215	215	
	3.4	6.4	6.75	6.75	
900	250	350	350	350	←Max. Av. Ip. ←Plate to Plate load ←Grid to Grid Volts ←Watts drive
	7900	5400	7000	7000	
	164	206	215	215	
	4.1	6.5	6.75	6.75	

The 203-Z is an improved high mu zero bias version of the 203-A and 203-B type, specially designed for Class B Audio use. In practical application of Class B Audio the average plate dissipation is low compared with the peak output, so the use of the nickel anode with lower Safety Factor will in no way interfere with long-life and fine performance. The static plate current will be 35 ma. per tube at 1000 volts and 45 ma. at 1250 volts.

Regular Class B input and output transformers as manufactured for type 203-A tubes by Thordarson, Utah, Jefferson, General, Stancor, United, Kenyon, Inca, etc., may be used with the 203-Z tubes.

### ZERO BIAS TUBES

Zero Bias Tubes have a high amplification factor so that the static plate current at the rated plate voltage is at a value well below the rated plate dissipation of the tube with the grid return connected directly to the filament center tap.

The Zero Bias type of tube approaches the ideal for Class B audio amplifier use. Since the grid has no negative potential supplied from batteries or power pack, current will flow from grid to filament over the entire positive portion of the input cycle. The impedance of the grid filament circuit is constant enough to reflect a fairly uniform load resistance to the plate circuit of the driver stage, which is important in securing good quality.

Zero Bias tubes are very efficient and very easy to control when operated at their rated plate voltages. Raising the plate voltage slightly and applying a small amount of negative bias does not disturb the wave form to any great extent; however, excessive plate voltage with a corresponding increase of bias will distort the wave form to undesirable proportions.

In examining the characteristics of a good driver tube for a Class B audio amplifier, we find, for example, the 2A3 has an amplification factor of 4.2 when operating into the primary of a transformer whose secondary is unloaded, or working into grids that are negative and hence not drawing current. AC voltage applied to the grids in excess of the negative bias voltage causes current to flow reflecting load to the driver stage. The 2A3's operating at optimum load impedance have a voltage gain of 2.7. It is obvious that shifting the voltage gain of the driver tube from 4.2 to 2.7 during the input cycle results in distortion. To minimize this shifting of the voltage gain, Zero Bias tubes should be operated at the Manufacturers' ratings.

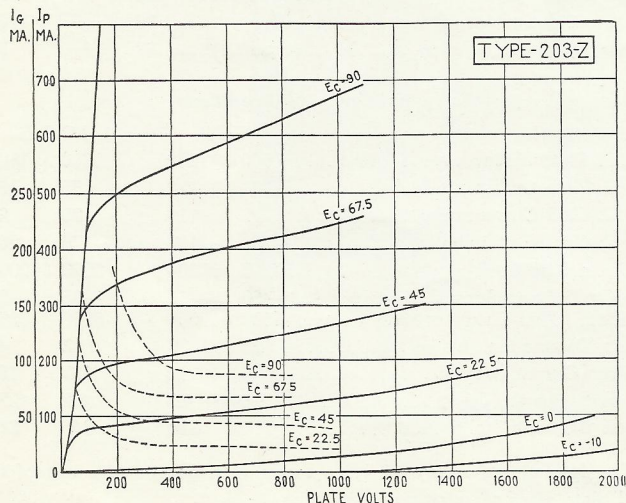



# Taylor

**CUSTOM BUILT**

# Tubes

## 805

**125 WATTS PLATE DISSIPATION  
CARBON ANODE**

**\$13.50**

**ZERO BIAS  
UP TO 510 WATTS  
CLASS B AUDIO OUTPUT**

The 805 is a high mu zero bias tube of popular type incorporating the use of the famous heat tested Speer processed carbon anodes together with the Taylor Floating anode type of construction. The plate lead is brought out the top greatly minimizing the chances of voltage breakdowns.

The no-signal or static plate current is about 55MA per tube at 1250 volts (zero bias) and about 30MA per tube at 1500 volts when 15 bias volts are added. Because the 805 is a zero bias tube, or practically so, grid current flows during nearly all of the input cycle. Due to this, the input transformer design requirements are less involved and excellent frequency response with minimum distortion is easily realized. The maximum average grid driving power is approximately 8 watts. Low impedance triodes such as 2A3's or 6A3's should be used in the driver stage.

### 805 CLASS B AUDIO DATA

Supply Voltage ↓	275	325	400	450	←Audio Watts Output
1750		270MA 15,000 4.5	330MA 12,000 6.0	390MA 10,000 9.0	←Max. Av. Ip ←Plate to Plate Load ←Watts Drive
1500	276MA 12,000 5.0	330MA 10,000 7.0	420MA 8,000 9.5	420MA 9,350 10.0	←Max. Av. Ip ←Plate to Plate Load ←Watts Drive
1250	335MA 8,000 6.25	395MA 6,800 8.5	←Max. Av. Ip ←Plate to Plate Load ←Watts Drive		

The chart above gives proper Class B Audio operating conditions for various outputs at different plate voltages. The most important value is the reflected load impedance which is given for the entire primary or plate to plate. The current value is the maximum average value as would be indicated on the plate current meter with sine wave input. For the same peak output with voice input the maximum average plate current will be approximately 50% to 60% of this value.

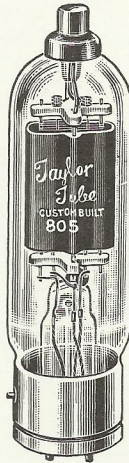
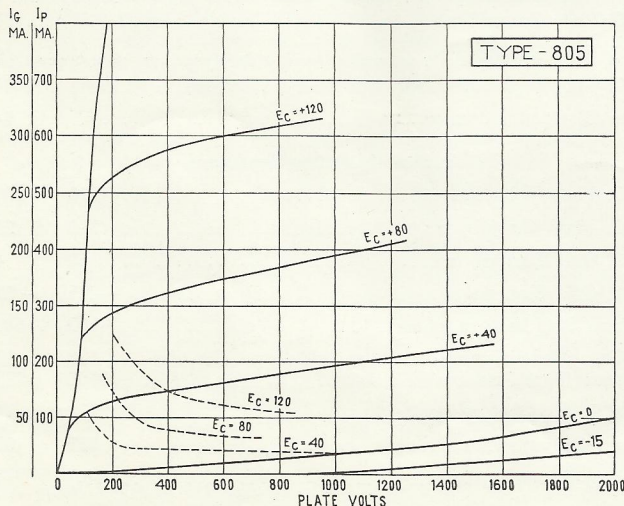

### GENERAL CHARACTERISTICS

Filament Volts .....	10
Filament Current, amps.....	3.25
Amplification Factor, approx.....	45
Plate Dissipation, watts.....	125

### Interelectrode Capacities

Grid-plate, mmf.....	7.7
Grid-filament, mmf.....	8.4
Plate-filament, mmf.....	1.3

### Overall Dimensions

Maximum length, inches.....	8½
Maximum diameter, inches.....	2½

50 Watt Base

Nonex Glass

### CLASS C TELEGRAPHY

#### Maximum Ratings

D. C. Plate Volts.....	1750
D. C. Plate Current, ma.....	210
D. C. Grid Current, ma.....	70
D. C. Grid Volts.....	500
Plate Dissipation, watts.....	125

#### Typical Operating Conditions

D. C. Plate Volts.....	1000	1500	1750
D. C. Plate Current, ma.....	200	200	200
D. C. Grid Current, ma.....	45	45	44
D. C. Grid Bias Volts.....	-75	-85	-90
From grid leak of, ohms.....	1650	1880	2000
Or { Fixed Supply of, volts.....	-30	-50	-60
From { Plus Grid Leak of, ohms.....	1000	780	700
Plate Dissipation, watts.....	56	72	80
Power Output, watts.....	144	228	270
Driving Power, watts.....	8.7	9	9.2

### CLASS C TELEPHONY

#### Maximum Ratings

D. C. Plate Volts.....	1500
D. C. Plate Current, ma.....	175
D. C. Grid Current, ma.....	70
D. C. Grid Volts.....	500
Plate Dissipation, watts.....	85

#### Typical Operating Conditions

D. C. Plate Volts.....	1000	1500
D. C. Plate Current, ma.....	175	175
D. C. Grid Current, ma.....	45	40
D. C. Grid Bias Volts.....	-100	-140
From grid leak of, ohms.....	2200	3500
Or { Fixed Supply of, volts.....	-30	-50
From { Plus Grid Leak of, ohms.....	1500	2250
Plate Dissipation, watts.....	50	55
Power Output, watts.....	125	208
Driving Power, watts.....	10.0	10.5

### CLASS B AUDIO

#### Typical Operating Conditions For Two Tubes

D. C. Plate Volts.....	1250	1500	1750
D. C. Plate Current, ma.....	400	420	420
D. C. Grid Bias Volts.....	0	-15	-22.5
Power Output, watts.....	325	400	510
Driving Power, watts.....	8.5	9.5	10
Plate to Plate load, ohms.....	6700	7850	9350
Peak Grid to Grid Volts.....	268	306	320



# Taylor



# Tubes

## T-200

200 WATTS PLATE DISSIPATION

**\$21.50**

AMATEUR'S POWER HOUSE TUBE

The T-200 has often been called "The Amateur's Power House Tube." A pair of these tubes push-pull will loaf along at 1 kw input on any frequency from 30 to 1.7MC. This tube uses the efficient flat form of construction and the inter-electrode capacities represent the best possible combination of inter-electrode capacities and other characteristics for best efficiency at moderate plate voltages with minimum grid drive requirements. The inter-electrode capacities are low enough for ease of neutralization yet are not so low that the characteristics of the tube are adversely affected. Many amateurs prefer a tube that will deliver good efficiency at high current and relatively low plate voltage and the T-200 is the answer. A plate modulated input of 450 watts with only 18 watts drive at 1500 volts is just what many have been thinking about and we recommend the T-200 highly under these conditions. A large percentage of high-powered transmitters on 75 and 160 meters use T-200's with great success.

The T200 is widely used in Diathermy equipment. This type of service is particularly hard on Tubes and the general acceptance of the T200 by many leading manufacturers of Diathermy equipment is convincing proof of the T200's rugged construction and conservative rating. Do not confuse the T200 with smaller tubes bearing the same type number.

### T-200 POPULARITY

SOME OF THE BEST HAM PHONE STATIONS USE TAYLOR T200'S. W9EDW, W9UAQ, W9KYM, W9VXZ, W9JDO, W8JOE, W8BWH, W91PS, W9ORA, W7CEO, W9NLP, W8CKC, W3EOZ, W3DQ, W9PZ, W8UD, W9LIP, W9ECA AND MANY OTHERS ARE T200 USERS.

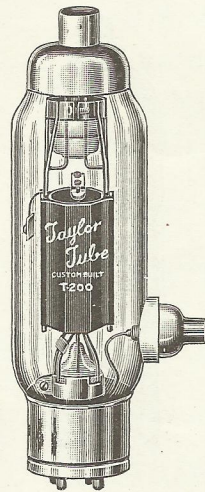
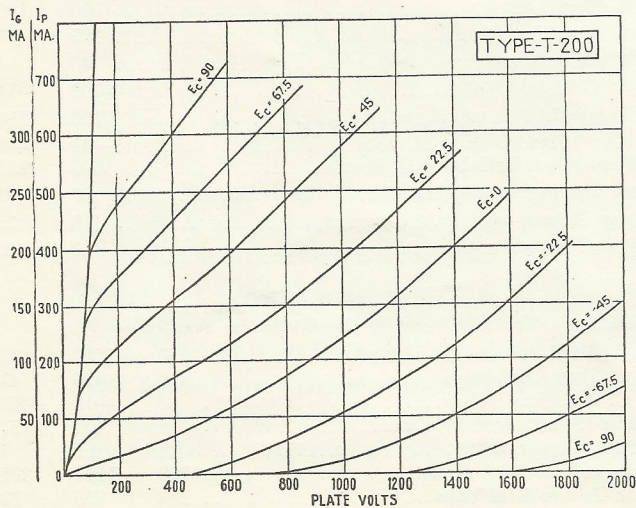

### GENERAL CHARACTERISTICS

Filament Volts .....	10.0
Filament Current, amps.....	5.75
Amplification Factor .....	17
Plate Dissipation, watts.....	200

### Interelectrode Capacities

Grid-Plate, mmf. ....	7.9
Grid-Filament, mmf. ....	9.5
Plate-Filament, mmf. ....	1.6

### Overall Dimensions

Maximum Length, inches.....	3 3/4
Maximum Diameter, inches.....	9 1/2

50 Watt Base

Nonex Glass

### CLASS C TELEGRAPHY

#### Maximum Ratings

D. C. Plate Volts.....	2500
D. C. Plate Current, ma.....	350
D. C. Grid Current, ma.....	60
D. C. Grid Volts.....	400
Plate Dissipation, watts.....	200

#### Typical Operating Conditions

D. C. Plate Volts .....	2000	2500
D. C. Current, ma.....	350	300
D. C. Grid Current, ma.....	56	48
D. C. Grid Bias Volts.....	-205	-265
From Grid Leak of, ohms.....	3640	5500
Or { Fixed Supply of, volts.....	120	150
From { Plus Grid Leak of, ohms.....	1500	2400
Plate Dissipation, watts.....	178	160
Power Output, watts.....	522	590
Driving Power, watts.....	21.7	20

### CLASS C TELEPHONY

#### Maximum Ratings

D. C. Plate Volts.....	2000
D. C. Plate Current, ma.....	300
D. C. Grid Current, ma.....	60
D. C. Grid Volts.....	400
Plate Dissipation, watts.....	140

#### Typical Operating Conditions

D. C. Plate Volts.....	1500	2000
D. C. Plate Current, ma.....	300	250
D. C. Grid Current, ma.....	50	41
D. C. Grid Bias Volts.....	-205	-220
From Grid Leak of, ohms.....	4100	5400
Or { Fixed Supply of, volts.....	100	125
From { Plus Grid Leak of, ohms.....	2100	2300
Plate Dissipation, watts.....	117	110
Power Output, watts.....	333	390
Driving Power, watts.....	18.7	15



# Taylor

**CUSTOM  
BUILT**

# Tubes

## T-125

WITH ACCELERATING FINNS  
125 WATTS PLATE DISSIPATION

### \$13.50

(Interchangeable With RCA 810)

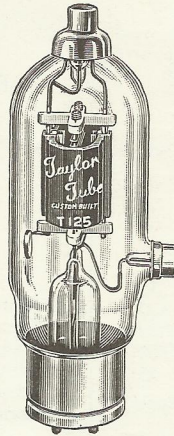

The T125 is the tube amateurs demanded to fill the gap between the T55 and T200. It's a mansized tube at low cost and it features a new TAYLOR invention (patent applied for) making possible high efficiency at low plate voltages and with low inter-electrode capacities. Rated conservatively, one tube will handle a full 500 watts input at the maximum ratings of 2000 volts, 250MA. The interelectrode capacities are low, making possible efficient operation on even the highest amateur frequencies—but the use of accelerating fins increases the inherent efficiency of the tube, making it far more efficient than others with comparative interelectrode capacities. These fins projecting inward toward the grid and filament effectively produce the very desirable characteristics of higher C tubes without greatly increasing the capacities. Thus this tube is truly unique in that it possesses the advantages of a low C tube together with the advantages of a higher C tube—without the disadvantages of either. It is truly a remarkable tube and is a revolutionary step forward in tube design.

At the rated plate dissipation of 125 watts the carbon plate shows no color but the accelerating fins operate at a bright orange color. If the type of operation or input are not such as to result in excessive dissipation, color showing on the plate may be taken as a definite indication that the circuit is less efficient than it should be.

For some time there has been a need for a high frequency tube to replace tubes of the 203A type with the absolute minimum of changes in the transmitter. The T125 fills the needs in a most satisfactory manner. Because of the exclusive TAYLOR Accelerating Fins construction, efficiencies on the order of those obtained with 03A's are possible at the same plate voltages and with the same low grid drive requirements. In addition the plate dissipation is greater than that of an 03A and the plate current rating greater making it possible to increase the power at the same Plate voltage as well as gaining the advantages of low C tube operation at the higher frequencies. In order to replace an 03A type of tube with the T125 it will be necessary only to change the grid and plate connections and to re-neutralize. If the minimum capacity of the neutralizing condenser is too high, plates may be removed. No circuit or bias changes are necessary because the Mu of the T125 is the same as that of an 03A.

### GENERAL CHARACTERISTICS

Filament Volts .....	10
Filament Current, amps.....	4.5
Plate Dissipation, watts.....	125
Amp. Factor .....	25

### Overall Dimensions

Max. Length, Inches.....	8¼
Max. Diameter, Inches.....	3

### Interelectrode Capacities

Grid-Plate, mmf .....	6.0
Grid-Filament, mmf .....	6.3
Plate-Filament, mmf .....	1.3
<b>Nonex Glass</b>	<b>50 watt base</b>

### CLASS C TELEGRAPHY

#### Maximum Ratings

	C.C.S.	I.C.A.S.
D. C. Plate Volts.....	2000	2500
D. C. Plate Current.....	250	250
D. C. Grid Current.....	70	70
D. C. Grid Volts.....	-500	-500
Plate Dissipation, watts.....	125	125#

#### Typical Operating Conditions

	C.C.S.		I.C.A.S.	
D. C. Plate Volts.....	1500	2000	2000	2500
D. C. Plate Current.....	250	250	250	250
D. C. Grid Current.....	35	34	34	35
D. C. Grid Bias Volts.....	-125	-150	-150	-200
From Grid leak of, ohms.....	3600	4300	4300	5700
Plate Dissipation, watts.....	99	118	118	125#
Driving Power, watts.....	10	10	10	12.5
Peak AC Grid Volts.....	315	335	335	400

# It is permissible to allow the plate dissipation to approach twice this value in telegraph service where key down condition exists approximately half the time.

### CLASS C TELEPHONY

#### Maximum Ratings

	C.C.S.		I.C.A.S.	
D. C. Plate Volts.....	1750	1750	2000	2000
D. C. Plate Current.....	210	210	250	250
D. C. Grid Current.....	70	70	70	70
D. C. Grid Volts.....	-500	-500	-500	-500
Plate Dissipation, watts.....	85	85	125	125

#### Typical Operation Conditions

	C.C.S.		I.C.A.S.	
D. C. Plate Volts.....	1500	1750	1500	2000
D. C. Plate Current.....	200	200	250	250
D. C. Grid Current.....	30	30	35	35
D. C. Grid Bias Volts.....	-150	-175	-165	-165
From Grid leak of, ohms.....	5000	5800	4700	4700
Or { Fixed Supply of, volts....	-60	-70	-60	-80
From { Plus Grid Leak of, ohms...}	3000	3500	3000	2500
Plate Dissipation, watts.....	70	78	94	120*
Driving Power, watts.....	8	9.5	11	12
Peak AC Grid Volts.....	315	345	360	380

\* The intermittent nature of voice modulation permits the use of the full plate dissipation rating of the tube.

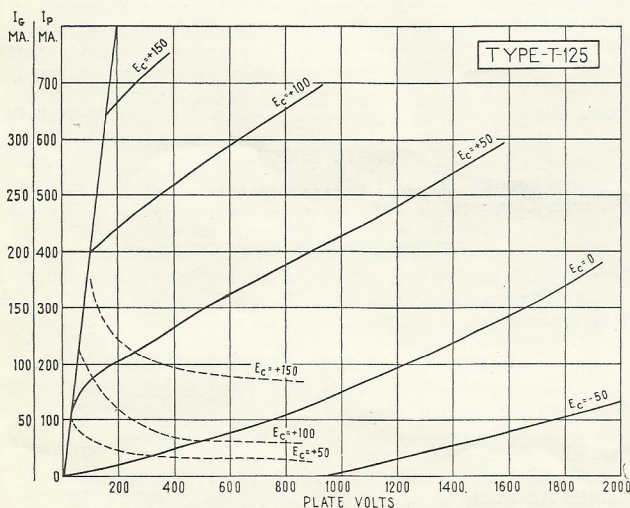



## 203-A

**EXACT REPLACEMENT FOR W.E.295-A**  
**100 WATTS PLATE DISSIPATION**  
**CARBON ANODE**

**\$10.00**

**GENERAL CHARACTERISTICS**

**TYPE 203-A**

Filament Voltage, volts.....	10
Filament Current, amps.....	3.25
Plate Resistance, ohms.....	6000
Mutual Conductance, uMhos.....	4200
Amplification Factor.....	25
<b>Nonex Glass</b>	<b>50 Watt Base</b>

**OVERALL DIMENSIONS**

Maximum Length, inches.....	7½
Maximum Diameter, inches.....	2½

**INTERELECTRODE CAPACITIES**

Plate to Grid, mmf.....	14
Grid to Filament, mmf.....	8
Plate to Filament, mmf.....	7

**CLASS "C" OSC. AND POWER AMP.**

Max. Operating Plate Volts	
Unmodulated D.C., volts.....	1250
Modulated D.C., volts.....	1000
Max. D.C. Plate Current, amps.....	.175
Max. D.C. Grid Current, amps.....	.060
Max. Plate Dissipation, watts.....	100
Max. R.F. Grid Current, amps.....	7.5

## 211-C

**EXACT REPLACEMENT FOR W.E.261-A**  
**100 WATTS PLATE DISSIPATION**  
**CARBON ANODE**  
**LOW INTERELECTRODE CAPACITIES**

**\$12.50**

**GENERAL CHARACTERISTICS**

**Type 211-C**

Filament Voltage, volts.....	10
Filament Current, amps.....	3.25
Plate Resistance, ohms.....	2800
Mutual Conductance, uMhos.....	4500
Amplification Factor.....	12.5
<b>Nonex Glass</b>	<b>50 Watt Base</b>

**OVERALL DIMENSIONS**

Maximum Length, inches.....	7½
Maximum Diameter, inches.....	2½

**INTERELECTRODE CAPACITIES**

Plate to Grid, mmf.....	9
Grid to Filament, mmf.....	6
Plate to Filament.....	6.5

**CLASS "C" OSC. AND POWER AMP.**

Max. Operating Plate Volts	
Unmodulated D.C., volts.....	1250
Modulated D.C., volts.....	1000
Max. D.C. Plate Current, amps.....	.175
Max. D.C. Grid Current, amps.....	.060
Max. Plate Dissipation, watts.....	100
Max. R.F. Grid Current, amps.....	7.5

## 211-211-D

These two types are identical  
**EXACT REPLACEMENT FOR W.E.242-A—276-A**  
**100 WATTS PLATE DISSIPATION**  
**CARBON ANODE**

**\$10.00**

**GENERAL CHARACTERISTICS**

**TYPE 211**

Filament Voltage, volts.....	10
Filament Current, amps.....	3.25
Plate Resistance, ohms.....	3400
Mutual Conductance, uMhos.....	3530
Amplification Factor.....	12
<b>Nonex Glass</b>	<b>50 Watt Base</b>

**OVERALL DIMENSIONS**

Maximum Length, inches.....	7½
Maximum Diameter, inches.....	2½

**INTERELECTRODE CAPACITIES**

Plate to Grid, mmf.....	14
Grid to Filament, mmf.....	7
Plate to Filament, mmf.....	6

**CLASS "C" OSC. AND POWER AMP.**

Max. Operating Plate Volts	
Unmodulated D.C., volts.....	1250
Modulated D.C., volts.....	1000
Max. D.C. Plate Current, amps.....	.175
Max. DC Grid Current, amps.....	.050
Max. Plate Dissipation, watts.....	100
Max. R.F. Grid Current, amps.....	7

## 845

**EXACT REPLACEMENT FOR W.E.284-A**  
**75 WATTS PLATE DISSIPATION**  
**CARBON ANODE**

**\$10.00**

**CLASS "A" AUDIO TUBE**

**GENERAL CHARACTERISTICS**

**TYPE 845**

Filament Voltage.....	10
Filament Current, amps.....	3.25
Plate Resistance, ohms.....	2100
Mutual Conductance, uMhos.....	3000
Amplification Factor.....	5
<b>Nonex Glass</b>	<b>50 Watt Base</b>

**OVERALL DIMENSIONS**

Maximum Length.....	7½
Maximum Diameter.....	2½

**INTERELECTRODE CAPACITIES**

Plate to Grid, mmf.....	14
Grid to Filament, mmf.....	6.5
Plate to Filament.....	6

**CLASS "A" AF AMP. AND MODULATOR**

Max. Operating Plate Volts, volts.....	1000	1250
Max. DC Plate Current, mills.....	75	65
Peak Grid Swing, volts.....	150	205
Max. Plate Dissipation, watts.....	75	75
Max. Audio Output, watts.....	21	24
*CLASS AB Audio Output watts.....	75	105

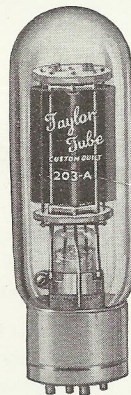



# Taylor

**CUSTOM  
BUILT**

# Tubes

## 822

200 WATTS PLATE DISSIPATION

### \$18.50

1000 WATTS AUDIO OUTPUT  
IN CLASS B AUDIO

An unusually efficient and rugged Tube especially designed for peak performance in Class B Audio and for all R.F. services on frequencies below 8 MC. Widely used in Commercial Services and in Diathermy apparatus where long-life under abusive conditions demands a Tube that "can take it." By far the most efficient tube available for 75 and 160 Meter Transmitters.



#### GENERAL CHARACTERISTICS

Filament Volts .....	10
Filament Current, amps.....	4
Amplification Factor .....	30
Plate Dissipation, watts.....	200

#### Interelectrode Capacities

Grid-Plate, mmf.....	13.5
Grid-Filament, mmf.....	8.5
Plate-Filament, mmf.....	2.1

#### Overall Dimensions

Maximum Length, inches.....	9
Maximum Diameter, inches.....	2 5/8
Standard 50 Watt Base	Nonex Glass

#### CLASS B AUDIO DATA

The chart below gives the max. average value as would be indicated on the plate current meter with sine wave input. For the same peak output with voice input the max. average plate current reading will be approximately 50 to 60 per cent of this value.

Supply Voltage ↓	400	500	750	1000	Audio Watts ←Output
3000		32000 230 ma. 2.6	21500 340 ma. 4.6	16000 500 ma. 8.0	←Plate to Plate load ←Max. Av. Ip. ←Watts drive
2500		22000 280 ma. 3.5	14500 410 ma. 6.0	10500 560 ma. 8.5	←Plate to Plate load ←Max. Av. Ip. ←Watts drive
2000	16800 285 ma. 3.25	13000 360 ma. 4.8	8800 525 ma. 7.4		←Plate to Plate load ←Max. Av. Ip. ←Watts drive
1500	9000 390 ma. 4.4	7100 500 ma. 6.7			←Plate to Plate load ←Max. Av. Ip. ←Watts drive

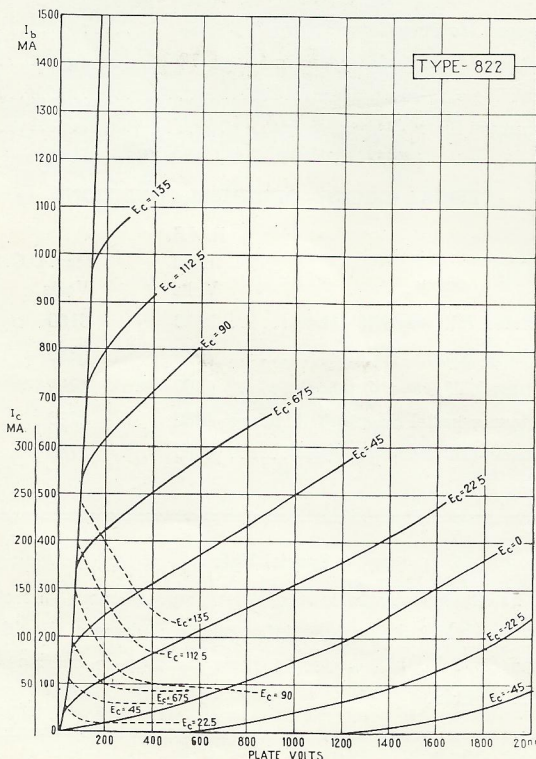

#### CLASS C TELEGRAPHY

##### Maximum Ratings

D. C. Plate Volts .....	2500
D. C. Plate Current, ma.....	300
D. C. Grid Current, ma.....	60
D. C. Grid Volts .....	400
Plate Dissipation, watts.....	200

##### Typical Operating Conditions

D. C. Plate Volts.....	2000	2500
D. C. Plate Current, ma.....	300	300
D. C. Grid Current, ma.....	51	51
D. C. Grid Bias Volts.....	-136	-190
From Grid Leak of, ohms.....	2670	3730
Or { Fixed Supply of, volts.....	-75	-100
From { Plus Grid Leak of, ohms.....	1200	1765
Plate Dissipation, watts.....	140	150
Power Output, watts.....	460	600
Driving Power, watts.....	14	17

#### CLASS C TELEPHONY

##### Maximum Ratings

D. C. Plate Volts .....	1000
D. C. Plate Current, ma.....	250
D. C. Grid Current, ma.....	60
D. C. Grid Volts .....	400
Plate Dissipation, watts.....	135

##### Typical Operating Conditions

D. C. Plate Volts .....	1750	2000
D. C. Plate Current, ma.....	250	250
D. C. Grid Current, ma.....	45	43
D. C. Grid Bias Volts.....	151	195
From Grid Leak of, ohms.....	3350	4500
Or { Fixed Supply of, volts.....	-65	-75
From { Plus Grid Leak of, ohms.....	1900	2800
Plate Dissipation, watts.....	92	95
Power Output, watts.....	345	405
Driving Power, watts.....	12.5	13.7

#### CLASS B AUDIO

##### Typical Operating Conditions for Two Tubes

D. C. Plate Volts .....	1500	2000	2500	3000
D. C. Plate Current, ma.....	500	500	500	450
D. C. Grid Bias Volts.....	-35	-45	-67.5	-80
Power Output, watts.....	525	720	900	1000
Driving Power, watts.....	7	7.2	7.4	8
Plate to Plate Load, ohms.....	6800	9500	12000	16000
Peak Grid to Grid Volts.....	286	306	351	362



# Taylor



# Tubes

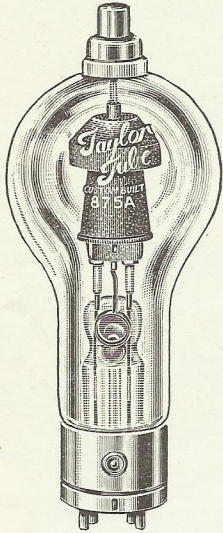

## 875-A

**CARBON ANODE AND SHIELD  
HALF-WAVE  
MERCURY VAPOR  
RECTIFIER TUBE**  
*For Broadcast Stations*

**\$30.00**

This new and greatly improved Taylor design incorporates the use of a Processed Carbon Anode and shield. This type is widely used in commercial services. A performance test will thoroughly prove the superiority of Taylor's 875-A's.

### GENERAL CHARACTERISTICS

Filament Volts ..... 5  
Filament Current, amps.....10

### Overall Dimensions

Maximum Height, inches.....10<sup>3</sup>/<sub>4</sub>  
Maximum Diameter, inches..... 3<sup>1</sup>/<sub>8</sub>  
50 Watt Base Nonex Glass

### Max. Peak Inverse Voltage

Condensed Mercury Temperature 20° to 50° C.....15,000  
Condensed Mercury Temperature 20° to 60° C.....10,000  
Max. Peak Plate Current, amps..... 6  
Max. Average Plate Current, amps..... 1.5

### TYPICAL CIRCUIT—MAXIMUM CONDITIONS

	R.M.S. Input Volts	Max. D.C. Output Volts	Amps.
Single phase full wave (2 tubes).....	5300	4750	3
Single phase bridge (4 tubes).....	10600	9500	3
Three phase half wave (3 tubes).....	6120	7150	4.5
Three phase parallel double Y (6 tubes)	6120	7150	9
Three phase full wave (6 tubes).....	6120	14300	4.5

### Special Note

In transit mercury in tube splatters over filament—therefore when first placing this tube into operation filament should be lighted for fully 15 minutes to allow mercury to condense to bottom of bulb.

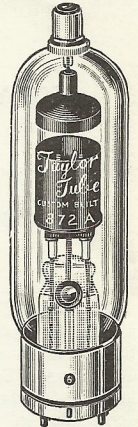

## 872-A

**NEW! . . . BETTER!**  
**HALF-WAVE  
MERCURY VAPOR  
RECTIFIER TUBE**  
*New Low Price!*

**\$10.50**

This new and greatly improved Taylor design incorporates the use of a Processed Carbon Anode and shield. Tried and proven in actual broadcast station use. A performance test will thoroughly prove the superiority of Taylor 872-A's. In a single phase full wave rectifier, with choke input, two 872-A's will deliver up to 2.5 amps. at 3200 volts D. C. Multi-strand filament.

### GENERAL CHARACTERISTICS

Filament Volts..... 5  
Filament Current, amps..... 6.75

### Overall Dimensions

Maximum Height, inches.....8<sup>1</sup>/<sub>4</sub>  
Maximum Diameter, inches.....2<sup>5</sup>/<sub>8</sub>  
50 Watt Base Nonex Glass

### Max. Peak Inverse Voltage

Condensed Mercury Temperature 20° to 60° C.....10,000  
Condensed Mercury Temperature 20° to 70° C..... 5,000  
Max. Peak Plate Current, amps..... 5.0  
Max. Average Plate Current, amps..... 1.25

### TYPICAL CIRCUIT—MAXIMUM CONDITIONS

	R.M.S. Input Volts	Max. D.C. Output Volts	Amps.
Single phase full wave (2 tubes).....	3530	3180	2.5
Single phase bridge (4 tubes).....	7060	6360	2.5
Three phase half wave (3 tubes).....	4080	4780	3.75
Three phase parallel double Y (6 tubes)	4080	4780	7.5
Three phase full wave (6 tubes).....	4080	4780	3.75

### Special Note

In transit mercury in tube splatters over filament—therefore when first placing this tube into operation filament should be lighted for fully 15 minutes to allow mercury to condense to bottom of bulb.



# Taylor

**CUSTOM  
BUILT**

# Tubes

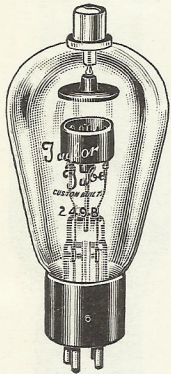

**249-B**  
**NEW! . . . BETTER!**  
**HALF-WAVE**  
**MERCURY VAPOR**  
**RECTIFIER TUBE**  
*New Low Price!*  
**\$5.00**

This new Rectifier tube uses a Processed Carbon Anode and shield together with the recognized advantages of Taylor's Multi-strand filament. The ceramic insulator between the plate cap and the glass gives increased voltage breakdown protection. 249-B's are widely used in Commercial Transmitters and during the past year many Taylor 249-B's went into this service with success. The Taylor 249-B is an exact replacement for tubes with the same type number.

**GENERAL CHARACTERISTICS**

Filament Volts.....2.5  
 Filament Current, amps.....7.5

**Overall Dimensions**

Max. Height, inches.....6 7/8  
 Max. Diameter, inches.....2 1/2  
**Nonex Glass**                      **UX 4 Prong Base**  
 (See Drawing)

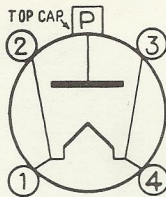

Max. Peak Inverse Voltage  
 Condensed Mercury Temperature 20° to 60° C, volts.....10,000  
 Condensed Mercury Temperature 20° to 70° C, volts..... 5,000  
 Max. Peak Plate Current, amps.....1.5  
 Max. Average Plate Current, amps.....0.375

**TYPICAL CIRCUIT—MAXIMUM CONDITIONS**

	R.M.S. Input Volts	Max. D.C. Output Volts	Amps.
Single phase full wave (2 tubes).....	3530	3180	.750
Single phase bridge (4 tubes).....	7060	6360	.750
Three phase half wave (3 tubes).....	4080	4780	1.12
Three phase parallel double Y (6 tubes)	4080	4780	2.25
Three phase full wave (6 tubes).....	4080	9560	1.12

**258-B — \$6.00**

Replaces tube with same type number and has same electrical and physical characteristics as 249-B except base has two 1/4 inch prongs only. Fits W.E. type 138-B socket.

**Special Note**

In transit mercury in tube splatters over filament—therefore when first placing this tube into operation filament should be lighted for fully 15 minutes to allow mercury to condense to bottom of bulb.

*New Shielded*  
**866 — \$1.50**

**HALF-WAVE MERCURY VAPOR  
 RECTIFIER TUBE**

**10,000 VOLTS PEAK INVERSE VOLTS**

THERE ARE OVER 25,000 TAYLOR 866's IN USE IN COMMERCIAL, BROADCAST AND AMATEUR RADIO TRANSMITTERS. TAYLOR 866's ARE KNOWN THE WORLD OVER TO BE THE LONGEST LIVED AND MOST TROUBLE-FREE 866's EVER MADE.

**"WHEN YOU BUY 866's—SAY TAYLOR 866's  
 AND YOU'LL GET THE BEST."**

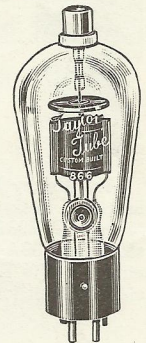

The shielding of the filament gives the Taylor Shielded 866 the same rating as all 866-A's. The ceramic insulator between the plate cap and the glass gives increased voltage breakdown protection. These Tubes can be used with equal success in any power supply requiring 866-A's. Uses famous Taylor Multi-strand filament which has twice usual emitting surface and Svea Metal Anode which greatly minimizes back emission.

**GENERAL CHARACTERISTICS**

Filament Volts.....2.5  
 Filament Current, amps.....5.0

**Overall Dimensions**

Maximum Height, inches.....6 1/4  
 Maximum Diameter, inches.....2 1/8

**UX 4 Prong Base**

Max. Peak Inverse Voltage  
 Condensed Mercury Temperature 20° to 60° C, volts.....10,000  
 Condensed Mercury Temperature 20° to 70° C, volts..... 5,000  
 Max. Peak Plate Current, amps..... 1.0  
 Max. Average Plate Current, amps..... 0.25

**TYPICAL CIRCUIT—MAXIMUM CONDITIONS**

	R.M.S. Input Volts	Max. D.C. Output Volts	Amps.
Single phase full wave (2 tubes).....	3530	3180	0.5
Single phase bridge (4 tubes).....	7060	6360	0.5
Three phase half wave (3 tubes).....	4080	4780	0.75
Three phase parallel double Y (6 tubes)	4080	4780	1.5
Three phase full wave (6 tubes).....	4080	9560	0.75

**Special Note**

In transit mercury in tube splatters over filament—therefore when first placing this tube into operation filament should be lighted for fully 15 minutes to allow mercury to condense to bottom of bulb.



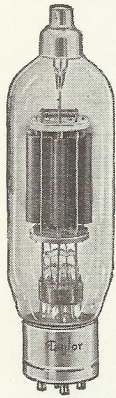

# HD 203-A

150 WATTS PLATE DISSIPATION  
CARBON ANODE

New Low Price!

Now— \$14.50

The Heavy Duty 203A is truly a heavy duty tube and was the first tube designed with the floating anode. Before the introduction of the HD 203A punctures and flashing over in the stems of the standard 203A were very common especially in Class B audio circuits. The HD 203A is a general purpose tube and is used in circuits built for 203A tubes where more power is desired.

### GENERAL CHARACTERISTICS

Filament Voltage, volts.....	10
Filament Current, amps.....	4
Amplification Factor .....	25
Plate to Grid, mmf.....	12
Thoriated Tungsten Filament—NONEX GLASS	
Maximum Length, inches .....	9½
Maximum Diameter, inches .....	2½

### CLASS "C" AMPLIFIER

Max. Operating Plate Volts.....	1500	1750
Max. D.C. Plate Current, mils.....	250	250
Max. D.C. Grid Current, mils.....	60	60

### CLASS "B" A.F. MODULATOR Push Pull Operation

D.C. Plate Voltage, volts.....	1500	1750
Grid Voltage, appr. volts.....	—45	—67.5
Load Resistance (plt. to plt.) ohms.....	9600	10,000
Max. D.C. Plate Current (2 tubes), mils.....	315	365
Power Output (2 tubes), watts.....	300	400

Supply Voltage ↓	200	250	300	400	←Audio Watts Output
1750	.180 20,000	.225 16,000	.275 13,000	.365 10,000	←Max. Av. Ip. ←Load Impedance plate to plate
1500	.210 14,500	.265 11,500	.315 9,600		←Max. Av. Ip. ←Load Impedance plate to plate
1250	.255 10,000	.320 8,000	.380 6,900		←Max. Av. Ip. ←Load Impedance plate to plate

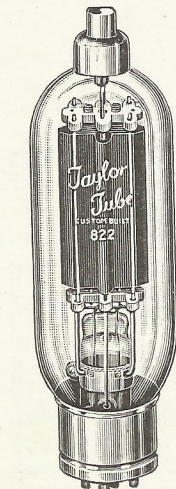

# 814

200 WATTS PLATE DISSIPATION

\$18.50

Low Mu—Ideal for Grid Modulation  
and Class B Linear Operation

The 814 is identical with the 822 except for the Mu or amplification factor and is intended for those applications where a tube of lower mu is desired. The mu of 12 is about optimum for grid modulated and class B linear R.F. operation. We recommend the 814 for efficiency modulated amplifiers.

# 204-A

250 WATTS PLATE DISSIPATION  
CARBON ANODE

\$60.00

The Taylor 204A is a three element air cooled power tube designed for use in transmitters as an oscillator, Radio Frequency Amplifier, and Class "B" Audio modulator. A Super Heavy Duty Carbon Anode is used which enables the tube to withstand overloads and still maintain stable characteristics. Because of its heavy duty construction and long life this tube is highly recommended for use in Broadcast transmitters where uninterrupted service is very essential. The characteristics of the Taylor 204A are standard. Detailed data will be supplied on request.



PERFORMANCE CURVE OF THE  
TAYLOR 204-A  
WILL BE SUPPLIED ON REQUEST

# 841-SW

50 WATTS PLATE DISSIPATION  
CARBON ANODE  
A POPULAR DIATHERMY TUBE

\$8.00

### GENERAL CHARACTERISTICS

Filament Voltage, volts.....	10
Filament Current, amps.....	2
Amplification Factor, .....	14.6
Maximum Length, inches.....	6¼
Maximum Diameter, inches.....	2½
Plate to Grid, mmf.....	9
Alsimag UX Base—NONEX GLASS	

### CLASS "C" OSC AND POWER AMP

Max. Operating Plate Volts	
Unmodulated D.C., volts.....	1000
Max. D.C. Plate Current, mils.....	150
Max. D.C. Grid Current, mils.....	30
Max. Plate Dissipation, watts.....	50
Max. RF Grid Current, amps.....	5

### CLASS B RADIO FREQUENCY AMPLIFIER

Typical Operating Conditions

D. C. Plate Volts.....	2000	2500
D. C. Plate Current, A.....	150	.125
Power Output, watts.....	110	115
Grid Bias Volts.....	—165	—200
Peak Driving Power, watts (approx.).....	6	6
Plate Dissipation, watts.....	190	197

For other Operating Data refer to 822 on Page 15



## OTHER TAYLOR TUBES

### 830-B

50 watts plate dissipation. Plate lead at top—UX 4-prong Alsimag base. Processed Carbon Anode. Standard electrical and physical characteristics.

**\$10.00**

### 838

100 Watts plate dissipation. Zero Bias type with standard Electrical and physical characteristics. Processed Carbon Anode with high Safety Factor.

**\$11.00**

### TF-100

An exact replacement for HF-100 type. Standard electrical and physical characteristics.

**\$12.50**

### 756

40 watts plate dissipation—carbon anode. Fil. 7.5 volts 2 amps. Plate 850 volts 110 MA amp. factor 20.

**\$3.95**

### 825

Same as 756 except amp. factor is 8.

**\$3.95**

### 203-B

Same characteristics as the 203Z except amp. factor is 25. Plate lead through base.

**\$7.00**

### HD-211C

150 Watt Diathermy Tube.....**\$14.50**

### 303 C

150 Watt Diathermy Tube.....**\$14.50**

### HD-203C

150 Watt Diathermy Tube.....**\$14.50**

Ask your distributor or write to us for information on use of Taylor Tubes as replacements in any Diathermy Machine.

## 866 JR.

HALF-WAVE

MERCURY VAPOR RECTIFIER

**\$1.00**



The 866 Jrs. fill a real need for intermediate power requirements. They are intended to be used as rectifiers in power supplies of from 600 to 1000 volts D.C. where the receiving type full-wave rectifiers will not stand up and where the power capabilities of the Heavy Duty 866's are not necessary. The smaller size of the 866 Jrs. is another feature that will prove to be of great advantage in the layout of compact power supplies.

### 866 JR.

#### GENERAL CHARACTERISTICS

Fil. Volts 2.5V  
 Fil. Current 2.5A  
 Max. RMS A.C. Volts 1250  
 Max. D.C. Current per pair (Choke input) 250 M.A.

#### PHYSICAL CHARACTERISTICS

Max. Length, Inches 5¼  
 Max. Diameter, Inches 2¼  
 UX Ceramic Base

Connect Plate Terminal to Usual Position Standard On All UX Bases

### 866 JR.

The 866 Jr. uses the multi-strand filament introduced by TAYLOR TUBES. The multi-strand filament construction used in TAYLOR rectifiers has twice the emitting surface of the nickel alloy ribbon type filaments used in ordinary 866's. The longer life secured with TAYLOR heavy duty 866's has proven that the use of the multi-strand filament and of a svea metal anode results in better rectifiers.

#### BLEEDER RESISTOR SPECIFICATIONS

Output Voltage	Resistance In Ohms	Actual Dissipated Power In Watts	Recommended Resistor Wattage Rating
500	25,000	10	25
1,000	50,000	20	50
1,500	75,000	25	50
2,200	100,000	40	100
3,000	200,000	45	100

A heavy-duty resistor should be connected across the output of a filter in order to draw some load current at all times. This resistor avoids soaring at no load when swinging choke input is used and also provides a means for discharging the filter condensers when no external vacuum-tube circuit load is connected to the filter. This bleeder resistor should normally draw approximately 10 per cent of the full load current. The above table gives suitable values of bleeder resistors for power supply systems with from 500 to 3,000 volts output.



## TUBE AND TRANSMITTER DATA

By Harner Selvidge—W9BOE

### I—FOREWORD

We believe that the information presented in the following pages will be worthwhile reading by the beginner as well as the advanced amateur. It has been compiled with the idea of helping him select a tube that will suit his particular requirements as well as his purse, and having selected this tube, to operate it in such a fashion that it will give the most satisfactory results. Those who already have transmitters in operation may find material in here which will enable them to adjust them even more successfully. It will be noted that the material is limited to pointers more or less directly connected with the functioning of your transmitting tubes. For all other circuit data as well as more detailed discussions of the subjects discussed in the following paragraphs, the reader is referred to either the ARRL or Radio Handbooks. We believe that one or the other of these handbooks should be in the possession of every active amateur no matter whether the input to his final amplifier is one or one thousand watts.

### II—HOW TO CHOOSE A TUBE

#### A—Power output and plate dissipation ratings.

The average amateur who is going to buy a transmitting tube probably consults first his pocketbook. As a result of this outlook he has some idea of whether he wants a low, medium, or high power tube. He may have a fairly definite idea of how much output he wants, but when the tube manuals are consulted he finds the rating of the tubes is given in terms of so many watts plate dissipation. The reason for this is that every tube has a certain definite limit to the amount of power it can dissipate at its plate. This point is discussed in detail in the section on "maximum dissipation." The amount that the user will be able to get OUT of the tube will depend upon the care with which he follows the manufacturer's recommendations and the efficiency of the circuits associated with the tube. However, he will find that the manufacturer will usually give some "typical operating conditions" and listed there will be found the power output that can be expected for that particular tube under those particular conditions. Sometimes a power supply of a particular size will be available, in which case a tube should be chosen that will give the most output when operated at this particular voltage. This is an important point because in these days of low priced tubes one of the biggest items of expense in a transmitter is the high voltage power supply.

#### B—RF or Audio use.

Whether the tube is to be used for RF or audio frequency work will have a bearing on the type to choose. For audio frequency work the interelectrode capacitances will not be of importance, nor will the insulation and isolation of the leads coming from the tube be an important point at these low frequencies. However, there are several things to be considered regarding the interelectrode capacitances of tubes to be used at radio frequencies, and these are discussed below.

Probably the most important way in which the interelectrode capacitances between the elements in a tube affect its operation is in the way they limit the operation of the tube at very high frequencies. Let

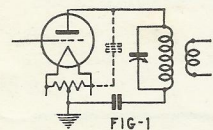

us consider the triode shown in **Figure 1**. The tube is connected in a circuit which is tuned to the operating frequency, and let us assume that the tube is operating as a radio frequency amplifier. Looking only at the plate circuit we see that the plate to filament capacitance (shown dotted) is in parallel with the tank tuning condenser. If we operate the amplifier at 3.5 mc.

the tank condenser will be perhaps 80 mmf and the plate to filament capacitance say, 5 mmf. It is thus almost negligible compared to the tank condenser. Therefore we find that the large RF current that always circulates in parallel tuned tank circuit will be largely confined to the tank circuit where it belongs. But if we operate this tube at 28 mc, where the tank condenser will be only 10 mmf or less, we find the plate to filament capacitance of 5 mmf an important part of the total capacitance. This will result in a large part of the high RF circulating current flowing through the tube, and since RF resistance increases rapidly with frequency, we may find the leads going into the tube get so hot that the glass seal where they go through the bulb will fail, or perhaps the leads may melt. This type of failure sometimes occurs when the tube is supposed to be operating only on some low frequency, and a very high frequency parasitic oscillation starts.

It will be seen from the above figure that the value of this plate to filament capacitance must be added to the tank condenser size to give the total value of the tank tuning capacitance. Later the choice of the proper ratio of tank inductance to tank capacitance (L/C ratio) will be discussed and it will be shown that for every given circuit using a particular tube at a certain plate voltage and frequency, there is a particular value of tank tuning capacitance that should be used. For very high frequency operation in the 28 and 56 mc bands this capacitance may be less than 10 mmf. In fact it may become so low that

the whole amount may be used up in the interelectrode capacitance. Thus to try and keep most of the tank circuit out of the tube to avoid the troubles mentioned in the preceding paragraph, we are forced to use a higher capacitance than the optimum value, with a resulting loss of tank circuit efficiency.

The effects described above become progressively worse as the frequency of operation is increased, and there is no hard and fast rule as to where they become objectionable. From a practical standpoint, however, a tube with a very low interelectrode capacitance will probably begin to show some superiority at 30 mc. and will be necessary for very efficient operation at higher frequency. There are however, two disadvantages in the use of these low capacitance tubes. The large spacing between the elements necessary to obtain the low capacitance makes it necessary to operate them at rather high plate voltages in order to obtain good efficiency. This means additional expense for high voltage transformers, filter condensers and insulation. In addition, this use of high plate voltages means higher driving power is required. We are obliged to accept these disadvantages in order to obtain good efficiency at ultra high frequencies, but for frequencies of 30 mc. and lower, it is usually more economical to use tubes which will operate with lower plate voltages, thus saving money on power supplies and driving power requirements. A less important disadvantage in the use of tubes requiring large plate voltages is that they require somewhat higher bias voltages.

#### C—High mu vs. low mu tubes.

If your choice of tube is in the low or medium power class, you will probably find that there is listed in the tube catalog two tubes with the same plate dissipation rating, one of them being designated as a high mu, or zero bias tube. The widespread popularity of this type of tube since they have been made available in recent years makes it important for us to consider the advantages and disadvantages of each type. The high mu tube is usually just like the low mu tube of a similar type except that it has a great many more turns of wire wound closer together for its grid. This makes the grid much more effective in controlling the electron stream, resulting in a mu, or amplification factor, which may be three times as large as the similar low mu tube. These are sometimes called zero bias tubes because when there is zero grid bias, the plate current is almost zero, or cut off. It is not cut entirely off because for practical reasons it is impossible to make the spaces between the grid wires so small that no electrons will get through when there is zero grid bias. Thus we find that the actual zero bias tube has a small amount of plate current flowing when there is no voltage on its grid. This zero bias plate current varies from about 18 ma for a TZ20 to 75 ma for an 805.

The most widespread use of the high mu or zero bias tube is in class B audio amplifiers. The fact that the tube is practically cut off at zero bias means that it is possible to construct a class B amplifier stage with little or no bias supply needed. Further details on this form of operation are given later in the section on class B amplifiers.

When a tube is used as a class C radio frequency amplifier it is customary to supply a grid bias either by means of a battery or power pack, or a grid leak, or some combination of both. From a dollars and cents standpoint, the grid leak bias is the cheaper, but has one drawback. The voltage developed across the grid leak results from the DC flowing in the grid circuit. This current is caused by the rectification of the RF driving voltage in the grid circuit. Suppose that the RF excitation or driving voltage of this amplifier were shut off, by keying, or by some failure in a preceding stage. At once the grid current would cease to flow and the bias on this amplifier stage would fall to zero. In the case of a T40 this would result in a plate current of 80 ma at 1000 volts. Now this is less than the rated plate current, but the input to the plate is then 80 watts, and nothing is going out. Therefore the plate would have to dissipate the whole 80 watts, which is a 100 percent overload. If this were noticed at once and the set shut down it probably would not be serious, but if it were not noticed for some time, serious damage to the tube might result. The usual way of avoiding this is either to use battery or power supply bias, or else place enough battery bias in series with the grid leak to limit the current to a safe value in case of excitation failure. Had the tube in question been a TZ40, however, the zero bias plate current would have been only 25 ma at 1000 volts for an input of only 25 watts which the plate can dissipate easily. Therefore, an advantage of the zero bias tube is that no fixed bias supply is required for safety reasons in a RF amplifier.

As far as actual driving power is concerned, there is little to choose between the low and high mu tubes. The low mu tube is usually operated as a class C RF amplifier with a more negative value of grid bias than the high mu tube. In actual power consumed in driving the grid, the high mu triodes generally require more than a low mu version of the same type. The plate efficiencies are nearly the same, the high mu tube showing a slight improvement in some cases. The low mu tube has a high grid impedance and the high mu tube a low



grid impedance, and this point should be remembered if a direct substitution is made in a circuit where the other type of tube has been used. Some readjustment of the input circuit will have to be made to match the different impedance to the driver. In practical circuits the low grid impedance of the high mu tube sometimes more nearly matches the driver impedance thus making the zero bias tube apparently easier to drive.

If the tube is to be used as a control grid modulated class C amplifier a low mu tube should be chosen. This will result in greater linearity of modulation. (See later paragraph on control grid modulation.)

#### D—Grid driving power.

It may be that the power required for grid excitation is the deciding factor in your choice of a tube. This would be true if a stage were being added to a low powered transmitter and thus only a limited amount of grid driving power would be available. There is one important thing to remember about the driving power rating of a transmitting tube. That is driving power is the power actually needed in the grid circuit of this tube to drive it properly, and this means that the driver tube must be able to supply this amount of power over and above that lost in the driver plate circuit, the coupling device, and the amplifier grid circuit. These losses can be considerable at the higher frequencies and if you plan to operate on the higher frequency amateur bands be sure to have plenty of driving power available. Bear in mind also that your driver stage will probably have somewhat lower efficiency at these frequencies. While it is important to have sufficient driving power available particularly for phone operation, it is equally important not to over drive the amplifier tube, and some means should be provided to give a smooth and continuous adjustment of the driving power. The importance of the proper value of excitation makes the investment of a small sum for a grid current meter very worth while, as this will give a direct check on the grid driving power.

### III—CHOICE OF OPERATING POWER

#### A—Meaning of maximum ratings.

Having chosen the tube best suited for your particular application, the next problem is to determine the operating conditions for that use. That is, what plate voltage, grid bias, etc. are required for that tube. Nearly all manufacturers give two types of data on their tubes in their catalogs. You will find under each tube the "maximum ratings" and then "typical operating conditions". The manufacturer gives these typical operating conditions as his recommendations as to how the tube may be operated to give satisfactory results. The simplest procedure is to follow these values, and then if you find that the tube behaves as predicted under these conditions in your circuit, you may be assured that it will give satisfactory service and long life. However, it may be that you would like to use some other values of plate voltage, or bias voltage on the tube in your particular application, and for the guidance of those who wish to do this, the list of "maximum ratings" is prepared. It will be noted that maximum ratings are given for plate dissipation, plate voltage, plate current, and grid current. It should be emphasized that for best service no one of these maximum values should be exceeded under any conditions. The reasons for this limitation are given in the following paragraphs.

#### MAXIMUM PLATE DISSIPATION

A transmitting tube is not a perfect device for transferring energy, and we find that when we put, say 100 watts DC into a tube, we get only about 75 watts RF out. This missing 25 watts came out, all right, but in the form of heat and not electrical energy. Thus the tube has had to dissipate or radiate 25 watts in the form of heat. The burden of this falls on the plate, and the maximum plate dissipation of a tube is that number of watts which the manufacturer believes the plate of that tube can safely radiate. The amount of heat a given plate can radiate depends largely upon its area, and the characteristics of the plate surface. A plate with a large area will radiate a lot of heat, and this is the reason for the fins sometimes found on metal plates. From our physics books we learn that a black body will radiate heat much more effectively than a white shiny one. Here is one of the greatest advantages of the carbon plate, its ability to radiate heat very effectively.

The amount of heat that can be tolerated in a tube is determined by several factors. First, the plate must not get so hot that heat radiated from it will heat the nearby grid to the point where it will emit electrons. Second, the plate and other elements must not get so hot they might release any small amounts of residual gas which might be held in them. Third, the plate and other elements must not get so hot that they will warp and thus get out of alignment. Fourth, in the case of metal plates, they must not get so hot that they or their supports will melt. Fifth, the plate must be large enough to dissipate the heat which comes to it directly by radiation from the hot filament. All these things are considered by the manufacturer in deciding how much plate dissipation he will allow for a particular tube. The heavy carbon plates on Taylor Tubes are so constructed that when they are operated at normal plate dissipation, no color will be visible. Any

sign of red on these carbon plates is an indication that the maximum rated plate dissipation is being exceeded. "Typical operating conditions" usually specify conditions which will result in the tube operating at maximum plate rating. It is not recommended that any maximum ratings be exceeded, but operating a carbon plate tube in excess of its rated plate dissipation will probably result in less harmful effects than exceeding plate voltage or current ratings, particularly of the tubes are well cooled by a forced air draft. The amount of overload a tube can stand is also tied up with the type of operation. For example, the bad effects of exceeding rated maximum plate dissipation will be less in the case of CW operation, where the plate may not have time to seriously overheat if the key is not held down too long.

#### MAXIMUM PLATE VOLTAGE

In the days when transmitting tubes were made with the leads all coming out of the mud base with some rather dubious spacing in the envelope which was filled with just as dubious a vacuum, there was a very definite limit on the maximum plate voltage that could be applied without spark-over. But now with the plate lead coming out the top on even the lower voltage transmitting tubes (like the T20 for example), and with good internal insulation and high vacuums, the plate voltage is no longer limited by voltage breakdown. As a matter of fact, the T20 rated at 750 volts DC, will actually stand more than 3000 volts on its plate without breaking down. The plate voltage is therefore not limited by break-down, but by considerations of filament emission and tube life. The plate voltage (together with the grid voltage) determines the peak current that is drawn from the filament, and exceeding the rated maximum plate voltage will usually result in shortening the life of the tube.

#### MAXIMUM PLATE CURRENT

The manufacturer selects for the maximum DC current rating of his tube one which experience and life tests have shown him will give a satisfactory life for that tube. It is sometimes possible to operate a tube in a very efficient manner using plate voltage and plate currents which exceed the maximum set by the manufacturer, without exceeding the plate dissipation, for example, and without apparent damage to the tube. However, such operation almost invariably results in decreased life for the tube cause by overloading the filament by high peak plate currents, resulting in the emission falling in a short time. As soon as the ratings are exceeded, all the rules are off, and there is no way of tell if the tube life will be reduced 10 per cent or 80 percent by operating, say, at 20 percent over the maximum current rating.

#### MAXIMUM GRID CURRENT

The grid in a tube finds itself in a awkward place. It is surrounded on the outside by the plate, which is usually rather hot, and it holds in its arms, as it were, the filament, which is also radiating heat. We find, therefore, that it is important to keep the grid current below a maximum value that will not cause undue heating. If the grid gets hot enough to cause it to emit electrons, these departing negative charges leave it more positive, so it will be bombarded by more electrons from the filament, heating it so it emits even more, and very soon the increased positive grid causes the plate current to reach abnormally high values and may destroy the tube. Thus we find it necessary to limit the permissible grid dissipation by setting a maximum value for the DC grid current.

#### B—Operating condition for class C amplifiers.

The class C amplifier is discussed first because it is the most common amplifier in use in amateur transmitters. Like other amplifiers, in a Class C amplifier an alternating voltage is applied to the grid circuit and is amplified and appears in the plate circuit. In the class C amplifier, the negative bias on the grid is more negative than that value which just cuts off the flow of DC plate current. In fact one common way of adjusting class C amplifiers is to set the grid bias at a value which is twice cut-off. For example cut-off for a T40 with 1000 volts on the plate is about 40 volts. Satisfactory class C operation will be obtained with a grid bias of 2 x 40 or —80 volts. In this connection it should be noted that with triodes it is not necessary to look at the characteristic curves to find the value of cut-off bias, just divide the plate voltage by the amplification factor. For example for the case of the T40, the amplification factor is 25. The plate voltage, 1000, divided by mu of 25 gives 40 volts, the same value of cut-off bias that is obtained by looking at the plate voltage plate current curves.

Because of the large negative bias on the grid of a class C amplifier, the plate current only flows in short pulses during the length of time that the positive tops of the RF voltage applied to the grid are greater than the cut-off voltage. Because the plate current flows in pulses, and not a sine wave like the applied grid voltage, the resulting amplified signal is full of harmonics, and it is necessary to use a tuned circuit in the plate to get rid of them and let only the desired frequency appear across the plate load.



### ADJUSTMENT FOR MAXIMUM EFFICIENCY

The class C amplifier can be operated at an efficiency which may exceed 80 percent. In deciding upon the operating conditions wanted, the builder is confronted with two alternatives; he can follow the tube manufacturer's recommendations and operate as outlined under "typical operating conditions" which are usually fixed to give an efficiency of about 75%, or he can select his operating voltages and biases to give some other result. If he is interested in getting the maximum possible efficiency, he should bias the tube to three or four times the cut-off value and then increase the grid driving voltage to keep the DC grid current constant. The efficiency can also be increased by increasing the plate voltage. However we don't get something for nothing, because these increases in efficiency are always accompanied by increased driving power requirements. In fact the necessary driving power may be more than doubled. If you have plenty, go to it. If you have only a small amount of driving power available use a grid bias voltage that is somewhat less than two times cut-off. It is entirely up to the designer whether he wants high efficiency or not. The data for "typical operating conditions" with its resulting efficiency of 70 to 75% represent an average condition which will prove a satisfactory solution for most amplifiers.

### DRIVING POWER REQUIREMENTS

The driving power listed in the tube characteristics represents the power actually required in the grid circuit of the tube, and represents power dissipated in the grid itself, and in the bias supply. In the latter it is either ohmic loss in the resistor type of bias, or power used in charging the battery in battery bias. However, there will be other losses such as in the grid tuned circuit, in the coupling device, and in the plate load circuit of the driver tube, so it is necessary to have a tube for a driver that will give more output than that which is given as the requirement for the class C amplifier tube. For example in a class C amplifier circuit requiring 10 watts driving power, it would probably be a good idea to have a tube that would give 20 watts output available. Of course with medium power tubes such as this, the driving power is not so much of a problem since the introduction of tubes like the T21, which are quite inexpensive and capable of outputs better than 20 watts each. It is very worth while on any exciter to have a way of varying the amount of excitation, so as to get exactly the right amount of driving power (as indicated by the DC grid current) for the class C amplifier. This can be done with the T21 by varying the screen voltage. Another way is to couple the exciter to the amplifier thru a condenser or a link that can be varied to adjust the driving power.

### BIAS SUPPLY FOR CLASS C AMPLIFIERS

Since the construction of a bias supply sometimes requires attention to factors not encountered in the usual run of power supplies, the following paragraphs are devoted to some of these points. Here again, the reader is referred to the various radio handbook for more detailed information.

The most common source for bias for a class C amplifier is by use of a grid leak resistance in the grid circuit. The grid is driven positive on the peaks of the RF grid voltage, and the resultant grid current which flows builds up a voltage drop across the resistance. The proper size for the grid resistor can be easily computed from the values of grid bias and DC grid current specified by the manufacturer. For example in the T40 for class C telegraph operation the grid current is specified as 40 mils with a grid bias of -85 volts. To find the resistance that will give a drop of 85 volts with 40 mils current, apply ohms law as follows:

$$R_g = \frac{85}{.040} = 2125 \text{ ohms}$$

If a push-pull amplifier were used, twice this current would flow in the common grid return lead, so the resistance necessary would be half as large. The disadvantage of this method of obtaining grid bias was pointed out in a preceding section; if the RF exciting voltage, is stopped by keying a preceding stage, or by the failure of some part of the equipment, the bias will fall to zero, and in the case of low mu triodes, the plate current will rise to a disastrously high value.

There are several ways of avoiding this difficulty. One is by the use of the high mu or zero bias tubes. The other is to have some of the bias voltage supplied from a source that does not depend upon the grid driving power. Just enough can be supplied in this manner to keep the plate current from reaching too large a value in the event of excitation failure. One method is to place a resistance in the cathode or filament circuit as shown in figure 2. It will be seen that both the plate current and grid current flow in this circuit and that the voltage drop across this resistance  $R_c$  will be in series with that across  $R_g$ . Thus in the event of excitation failure, the plate current will start to rise, but the more it rises, the more negative grid voltage there will be developed across the resistor  $R_c$  thus reducing the plate current. One of the disadvantages of this method is that the voltage applied to the plate

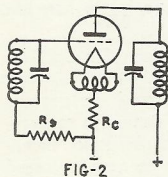

FIG-2

of the tube is then less than that of the power supply by the amount of drop in the filament resistance  $R_c$ . This method also requires a separate filament transformer for that stage. It would be safe to have, say, about half the bias developed in this fashion, for example; let us compute the size of grid and cathode resistances for a T40, letting -45 volts be supplied by the grid resistor, and the remaining -40 volts by the filament resistance. The values of these two resistances are found as follows:

$$R_g = \frac{45}{.040} = 1125 \text{ ohms}$$

This computation was made just like the preceding one. Now in the filament circuit we have both the plate and grid current returning to the filament, so to get the total current we must add the 115 mils plate current to the 40 mils grid current as follows:

$$R_c = \frac{40}{(.115 + .040)} = 258 \text{ ohms}$$

Another way of avoiding the trouble of resistor bias in class C amplifiers is to use all battery or part resistor and part battery bias. There is no current drawn from the batteries so it might be thought that their life would be the same as their shelf life. Unfortunately this is not the case, for while here is no current drawn from the batteries, the DC flowing in the grid circuit is in such a direction as to charge the batteries. Dry cells such as in B batteries express their disapproval of this treatment by developing rather high internal resistance after a while, along with an unstable voltage characteristic. Thus their replacement cost may be greater than first anticipated.

A low voltage power supply made of receiver parts makes a satisfactory and economical source of bias voltage. A bias supply of this kind is shown in figure 3. It will be seen that the lower half of the bias supply bleeder resistance is included in the grid circuit of the tube, and this resistance  $R_1$  is thus also acting as a grid leak. So the voltage appearing across, its terminals will be the sum of the power supply voltage existing across  $R_1$  plus the drop across  $R_1$  caused by the DC in the grid circuit flowing thru it. We will then have the combination of fixed, and grid leak bias, but with a power supply instead of a battery. In the case of a class C amplifier, it will, often be possible to omit the choke L and the second condenser  $C_2$  without getting objectionable hum. If this system is used to supply bias for several stages it will be found that the sum of all these grid currents flowing thru the resistance  $R_1$  will give rise to a very large voltage unless this resistor is kept quite small. This means that in order to have sufficient drop across it caused by the power supply, the other part of the bleeder resistance must be quite small in order to divide the voltage properly.

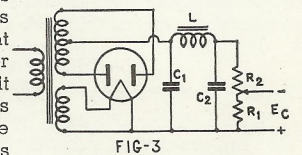

FIG-3

For applications where it is necessary to supply bias to several stages, and where a bias supply with good regulation is required such as in class B audio or RF amplifiers the addition of a regulator tube to the simple circuit shown in figure 3, makes a very satisfactory solution.\* This regulator tube connection is shown in figure 4. The regulator tube is usually a 2A3. Its filament must be heated from a separate transformer from that of the power supply, or from a separate winding on the same core. The resistance in the grid circuit of the regulator tube is 1 meg, 1 watt.

The voltage across this tube in this circuit tends to remain constant, no matter what the current. Thus it is essentially a device with zero internal resistance, and an external resistance such as  $R_g$  must be used if part of the bias voltage is to be obtained from the DC flowing in the grid circuit. The bias voltage of the regulator supply will be about 4/5 of that appearing at the point on the bleeder  $R_1$  where the grid is tapped. The 2A3 will handle 60 to 70 mils DC grid current. If the current is greater than that, two 2A3s should be put in parallel, thus doubling their current carrying capacity. If it is necessary to supply several amplifiers with bias, several 2A3s can be connected as shown to the same bleeder in the same circuit as shown in figure 4. The only precaution is to have a separate filament winding for each. A good solution is to use a transformer for the power supply that has a lot of filament windings on it.

#### \* Footnote

For further details on this type of bias supply see Yates, QST September 1934 or Dawley, Radio January 1937.

### NEUTRALIZATION OF CLASS C AMPLIFIERS

In all triode amplifiers we find that there is a path from the plate load circuit back to the grid circuit thru the plate to grid capacitance



within the tube, and at radio frequencies we find that enough voltage will be fed back to the grid circuit over this path to cause the tube to oscillate unless steps are taken to prevent it. Two things can be done; first shield the plate from the grid as in the screen grid tube, or second introduce into the grid circuit process known as neutralization, and all of the various neutralization circuits are just different ways of doing this. The voltage is picked up in the plate circuit and fed back thru a condenser in such a way as to be out of phase with the feedback voltage, and then its magnitude is adjusted until it exactly opposes the other. The circuits are quite simple, and the addition of the neutralization circuit to the amplifier adds little to its cost, and in most cases is quite easy to adjust and keep in satisfactory operation.

There are several ways in which a single tube RF amplifier can be neutralized. Either the neutralizing voltage is picked up on the plate of the tube and fed back into the tuned grid circuit, figure 5, or else

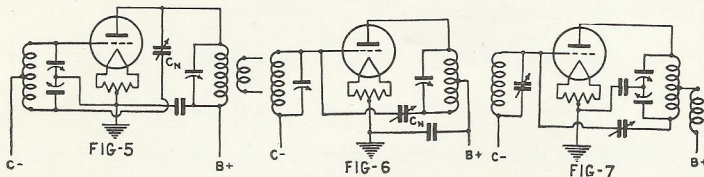

the voltage is picked up in the tuned plate circuit and fed back to the grid of as shown in figures 6, 7 and 8.

This so-called plate circuit type is the most common type for single tube RF amplifiers. In the grid circuit neutralization, figure 5, the neutralizing voltage is picked at the plate of the tube and fed back to the balanced grid circuit thru the small condenser C<sub>n</sub>. The grid circuit is entirely symmetrical and the only adjustment that needs to be made is in the size of C<sub>n</sub>. The exact method of adjustment is the same for all types of neutralization and is given in one of the following paragraphs.

Three circuits are shown for plate circuit neutralization. It is very desirable that when once neutralized at a particular frequency the circuit will remain neutralized at all other frequencies. This becomes increasingly difficult at the highest amateur frequencies because of the increasing effect of the inductance of even short leads, and the importance of random circuit capacitances. For this reason the circuit shown in figure 8, is recommended for multi-frequency operation of single-ended amplifiers. The other two circuits for plate neutralization can usually be adjusted to exact neutralization at one frequency, but when shifted to another, will be way out of line. The circuit elements in all these circuits have the usual values, the only thing out of the ordinary is the condenser C<sub>t</sub> in figure 8. This condenser is paced in the circuit to balance out the effect of the capacitance from plate to filament of the tube, and is about the same size as this capacitance. That is to say, it will be about the same size as the neutralization condenser C<sub>n</sub>. Anyone who has had bad luck trying to

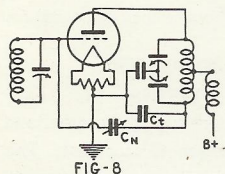

neutralize a single ended amplifier should try this circuit. The addition of the balancing condenser C<sub>t</sub> destroys an unbalanced condition that is particularly troublesome at high frequencies.

Figure 9, shown the method of neutralizing a push-pull RF amplifier.

Here the electrical symmetry arising from the use of two tubes in the push-pull circuit and the easy mechanical symmetry of the parts lay-out makes the problem of neutralization a very easy one. The neutralizing voltage is picked up off each end of the plate tank circuit and fed back to the opposite grid thru the neutralizing condenser C<sub>n</sub>. If everything is exactly symmetrical, these two condensers should be exactly the same size, and they are some time ganged together for ease of adjustment. Little trouble is experienced with this type of circuit.

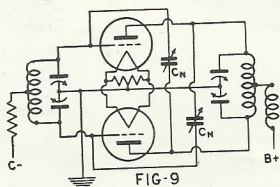

The adjustment of the neutralization circuit is quite simple, providing some sort of an indicating instrument is available. Proper neutralization is indicated by the absence of any RF in the plate circuit of the neutralized stage when RF is applied to its grid circuit with the filament lighted and no plate voltage applied to the tube. This absence of RF can be detected by a neon bulb touching the plate coil, but this

is not generally satisfactory, as the RF voltage may be small enough not to light the neon bulb, and yet cause trouble in the amplifier. A thermogalvanometer coupled with a few turns of wire to the plate tank coil is a very good indicator, but not likely to be available to every amateur. A few turns of wire and a flash-light bulb held near the plate coil makes a fair indicator, but suffers, like the neon bulb, from lack of sensitivity. However, if the neutralizing condensers can be adjusted so that the flashlight bulb just goes out, and that setting noted; then keep rotating the neutralizing condensers until the bulb just starts to light again. The proper point will be about half way between these two settings. But the most satisfactory sort of indicating instrument is one that every amateur ought to have in his final amplifier; a DC grid current meter.

The way the grid current meter indicates proper neutralization is as follows: The circuit is placed in operation as described above and it will be noted that because the filaments of this stage are lighted the RF will be rectified and DC grid current will flow if there is normal excitation. The excitation is adjusted so that when the grid circuit is tuned to resonance a good sized reading will appear on the grid meter and then the plate tank condenser of the amplifier stage is tuned thru resonance. If there is any RF from the grid circuit getting in the plate circuit, as it would if the stage were not neutralized properly, the tuning of the plate circuit thru resonance would put a slight loading on the grid circuit and cause the grid current to drop slightly. Then all there is to do is to adjust the neutralizing condenser (or condensers in the case of a push-pull circuit) until there is no longer any movement of the grid current meter when the plate tank condenser is tuned thru resonance. Care should be taken in a new transmitter to be sure that the plate tank condenser is the proper size to tune the plate inductance to resonance at the frequency in question. The use of a grid current meter is so important in adjusting the driving power of a stage so as to get the proper operating conditions that the driving power of a stage so as to get the proper operating conditions that it is quite important to have one available for this purpose as well as for a neutralization indicator.

## INPUT IMPEDANCE

In the section which discussed the relative merits of high and low mu tubes, mention was made of the difference in their input impedances. That is the average RF impedance the input of the tube offers. To get proper driving power with a minimum of available power, it is important that the impedances of the driver stage and the driven amplifier input be matched. But it doesn't do much good to know exactly what the grid impedance is, because this necessary impedance match is going to be made experimentally in most cases. So all we will say about the input impedance compared to low mu tubes. Also, if the grid bias is changed, the grid impedance is changed, higher negative bias meaning higher impedance. It is therefore very desirable to have some means available to enable the impedance of the driver to be matched to the input impedance of the driven tube, what ever it may be. Figure 10, and 11, show two ways

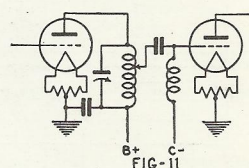
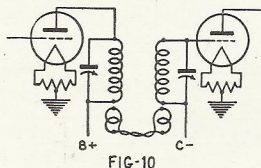

of obtaining this impedance matching. Figure 10, is the well known link coupling method and is the most common. The impedance can be matched by changing the number of turns on the link pick-up coils. This method is quite flexible, and has other advantages, such as affording a convenient method of adjusting the driving power by varying the link coupling, and also enables the driver stage to be located some distance from the amplifier if desired. The circuit shown in figure 11 has the advantage that no grid coil and condenser are required. The impedance matching adjustment is by moving the tap



up and down the plate tank coil. This will not afford such a wide variation in impedance matching as the link however.

### TANK CIRCUIT L/C RATIO

The operation of the amplifier tube depends to a considerable extent on the design and construction of its tank circuit. For a tank circuit of maximum efficiency the inductance should be as large as possible. However, for minimum harmonic radiation the tank condenser should be as large as possible. Thus we have two opposite requirements that must be satisfied. Naturally a compromise must be reached, and when the equations are all written out and the crank is tuned on the mathematical computations, we come out with the curves shown in figure 12, which give the proper sizes of condenser to be used in the tank circuit of an amplifier operated at a certain frequency with a given plate voltage and plate current. The value of capacitance obtained from these curves is that necessary to tune a coil with the plate lead at the bottom. For a **center tapped tank coil**, the **capacitance necessary** to tune it is **one fourth that given on the curves**. Of course, in case a split stator condenser is used, each section is twice the total necessary to tune the coil. Thus in the case of the **center tapped plate coil**, each section of the condenser would have a **capacitance of half that given by the curves**. Once the size of the condenser is known the inductance can be found for that particular frequency from the

formula  $L = \frac{1}{39.4 + C + F^2}$ , where L is in microhenries, C in

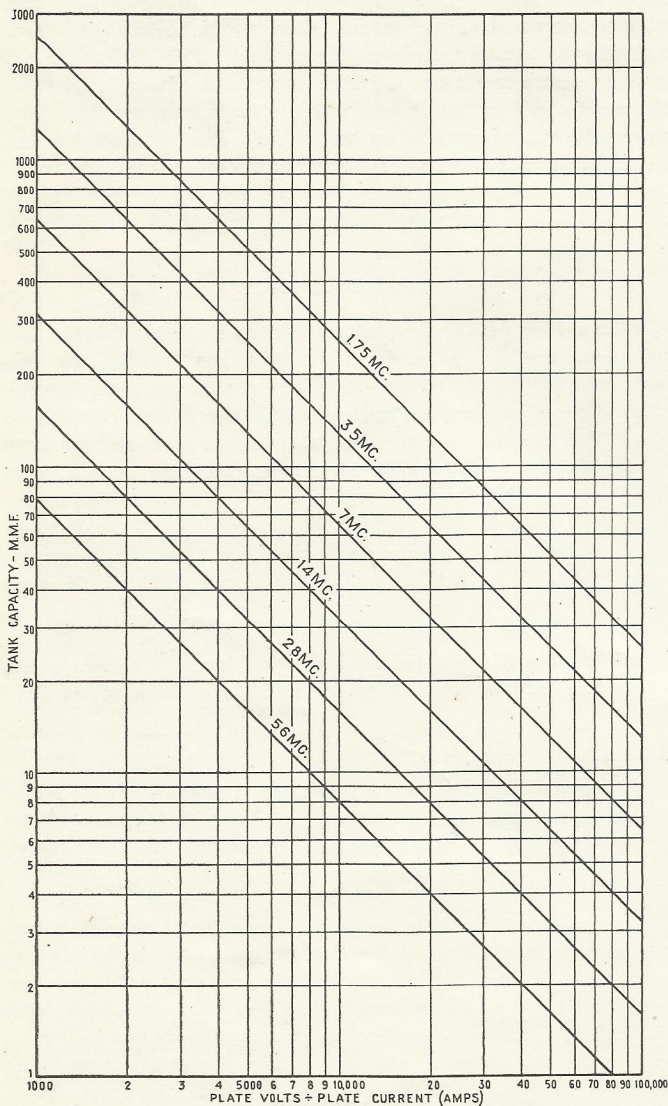

Fig. 12

microfarads, and F in mega cycles. Most of the ready made tank coils manufactured today are of such a size that they tune with approximately the optimum amount of capacitance. A simpler way of determining the L after C is determined is by use of the LC product for the various amateur bands.

f	LC	f	LC
1750	= 8271.0	14000	= 129.2
3500	= 2067.8	28000	= 32.3
7000	= 516.9	56000	= 8.0

$$L = \frac{LC \text{ product}}{C}$$

L = microhenries

C = micro microfarads

Thus if it is found that the desired value of effective tuning capacity C is 50 mmf for a 7000 KC tank circuit the L will be  $\frac{516.9}{50}$  or 10.3

microhenries. This is of little value unless we can construct a coil of this value with reasonable accuracy. The formula below will be found quite accurate.

$$L = \frac{.2 A^2 N^2}{3A + 9B}$$

Where  
 A = diameter of coil in inches  
 B = length of coil in inches  
 N = Number of turns

Example: To construct the coil of 10.3 uh assume that it will be wound on a 3-inch form and will be spaced to occupy a length of 6 inches.

$$10.3 = \frac{.2 (3)^2 + (N)^2}{(3 + 3) + (9 + 6)}$$

$$N = 19 \text{ turns}$$

If this coil were to be constructed in halves the only logical solution would be to use one less turn and operate with a capacity slightly greater than optimum.

### C-PLATE MODULATED CLASS C AMPLIFIER

Probably the most common method of generating radiotelephone signals is by the use of the plate modulated class C amplifier. The following paragraphs will describe the adjustment and operation of this type of amplifier and how it differs from the class C amplifier as used for telegraphy. When adjusted properly, a class C amplifier is found to have an output that is almost exactly proportional to the square of the plate voltage applied, so we find that if we vary the plate voltage at an audio frequency rate, this audio frequency will modulate the RF signal sent out by the amplifier. This is done by placing the secondary of an audio frequency transformer, in series with the plate voltage lead. As shown in figure 13. Then the audio frequency voltage which appears across the secondary of this transformer will be superimposed on the DC plate voltage of the amplifier and cause the amplifier to transmit a modulated RF signal.

Three things must be taken into account to obtain the great possible (freedom from distortion) linearity in the plate modulated class C amplifier. First, the excitation must be adequate. Remember that on the peaks of the audio voltage swings the total plate voltage will approach twice the DC plate supply voltage, and there must be sufficient grid driving power available to take care of this requirement. Second, the proper L/C ratio in

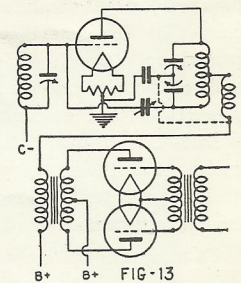



the amplifier tank must be obtained. The values given in the curves in figure 12, will be satisfactory, but if there is any variation the condenser should be larger than specified. Third, it is usually true that the linearity of a modulated class C amplifier is improved when its grid bias is supplied by combination of grid leak and battery (or bias pack) supply. Sometimes grid leak alone is used, but never battery only.

It will be realized that the addition of the audio frequency power to the plate circuit of the amplifier will put an additional load upon the plate of the class C tube. In fact the plate input will be increased by the amount of the audio power, and this means that if the amplifier were adjusted so as to have normal plate dissipation while unmodulated, the addition of the modulation would result in overloading the plate. Thus we must reduce the DC input to the class C stage when it is modulated. This is done by reducing the permissible plate voltage and sometimes the plate current also. This accomplishes the twofold purpose of reducing the input so the plate will not be overloaded, and reducing the plate voltage cuts down the high peak voltage which is developed when the peak audio voltage swing is superimposed on the DC plate voltage.

If the amplifier is to be modulated with sine wave 100% modulation, it requires that the modulator be capable of delivering 50% of the class C DC power input. That is, if we have a class C amplifier with 250 watts input, we will need 125 watts of audio power to modulate it 100% with a sine wave. Now fortunately for the amateur, speech is not a sine wave, and it requires much less energy to modulate a carrier with speech than it does a sine wave. In fact amateur practice is to use an amplifier that has an output only one third to one quarter of the DC input to the modulated stage. Thus for speech only, we can modulate the 250 watt amplifier mentioned above with an audio power of only about 75 watts.

The impedance that the plate circuit of the class C stage presents to the secondary of the modulation transformer is equal to the DC voltage divided by the DC plate current. Thus two T40s drawing a total of 230 mils at 1000 volts as a class C amplifier would require a modulation transformer to work into a load of  $1000/.23 = 4,350$  ohms. The most common modulator is the class B amplifier which is discussed later in a separate section.

#### GRID MODULATED CLASS C AMPLIFIER

In general if it is required to deliver a certain number of watts of modulated radio frequency energy, the most economical way is by the use of the plate modulated class C amplifier. If a telegraph transmitter is available, and it is desired to convert it into a telephone transmitter with the minimum of expense, the best way is by grid bias modulation. In this form of operation, the audio frequency voltage is superimposed upon the control grid of the class C amplifier, thus causing its output to be modulated by the audio frequency signal. The disadvantages of this type of modulation are that it is somewhat more difficult to adjust, and that in order to operate the amplifier so that there will be good linearity of modulation it is necessary to operate it under conditions that give rise to efficiencies in the vicinity of 30% as compared with 75% for the plate modulated amplifier. Recently there have been invented systems for grid modulation which have relatively high efficiencies, but their adjustment and operation are beyond the scope of the average amateur. Cathode modulation has also been suggested. This is a variation of grid modulation in that a small amount of audio power is added to the plate circuit during modulation of the grid circuit. In general the plate efficiency is raised to approximately 45% instead of 30% for grid modulation alone. A higher audio power is naturally required for cathode modulation. Anyone considering the construction of a cathode modulated transmitter should consider that a 50 watt plate dissipation tube operating at 50% efficiency will deliver a carrier of only 50 watts and that the same tube plate modulated will operate at 75% efficiency and deliver a 150 watt carrier.

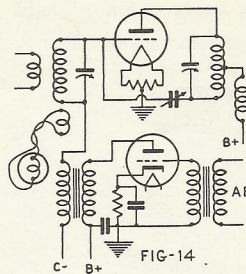

Figure 14, shows the circuit diagram for a control grid modulated amplifier. The fixed bias voltage should be supplied by a battery or a bias pack with a very low resistance bleeder. The grid bias voltage should be somewhat more negative than that used for the tube when operated as a class C amplifier for telegraphy. The linearity of the grid modulated amplifier depends to a very great extent upon the proper loading of the amplifier plate circuit, and the proper adjustment of the amplifier driving power. The lamp shown coupled to the amplifier grid circuit is used for loading this circuit to give better regulation of the driving power supply. The exact adjustment of this type of amplifier can be found in the handbooks, and the reader is referred there for additional information. Since the modulation is done in the grid circuit, it is almost entirely a voltage process, and the audio amplifier needs to supply very little power. For example, a 100 watt carrier can be completely modulated by less than a watt of audio power.

#### FREQUENCY DOUBLERS

In the section on class C amplifiers it was pointed out that the plate current flows from the tube in short pulses. This is very far from being a sine wave of a single frequency, but the harmonics, or multiples of the fundamental frequency which exist in the plate current are all eliminated by being short circuited by the plate tank coil which is tuned so that it offers a high impedance to the passing of the fundamental frequency only. Now if we are driving the amplifier with RF of say 4 mc, we will find that the output contains 4, 8, 12, and 16 mc. RF as well as even higher multiples of the original frequency. The strength of these currents are weaker the higher the frequency, and in the case of the push-pull circuit there is practically no sign of any of the even harmonics. If we tune the plate circuit of an amplifier to resonance for any one of these harmonics it will be found that all other components are short circuited and the amplifier will amplify this frequency only. If this is the second harmonic, or twice the frequency of the fundamental, the amplifier is said to be working as a doubler. Usually the harmonics higher than the second are so much weaker than the second that it is quite inefficient to operate a frequency multiplier as tripler, for example.

The problem in the operation of a frequency doubler is to get as much second harmonic as possible appear in the output circuit. This means that the plate circuit current pulses must be as sharp as possible. This demands a high bias, several times that required for normal class C operation. This extra negative bias, whether obtained from a very large grid leak or a bias supply power supply, means that the driving power and driving voltage will be greater than that required for operation as a straight class C amplifier. It is also advantageous to have a large ratio of tank inductance to capacitance for doublers, that is, a low C tank circuit. It is found that tubes with high amplification factor (high  $\mu$ ) have characteristics which are better suited for use as doublers than low  $\mu$  tubes. So for doubler operation, use a high  $\mu$  tube with lots of negative grid bias, and plan on having sufficient driving power available, perhaps twice as much as when the tube is used as a straight amplifier.

It will be found that when operated properly, the average high  $\mu$  triode frequency doubler will have an efficiency of perhaps 50%, so less output will be obtained than when operating the tube as a straight amplifier. Since the frequency to which the plate circuit is tuned is different from that to which the grid circuit is tuned, feed-back thru the plate to grid capacitance will not cause oscillation, and here we have an important advantage in the use of a tube as a doubler; it does not require neutralization. This is particularly an advantage in single ended amplifiers, where neutralization is more troublesome than in push-pull circuits. Of course if the amplifier is going to be operated



part of the time as a straight amplifier, it will have to be neutralized. The neutralization will have little effect on its operation as a frequency doubler.

### CRYSTAL OSCILLATOR CIRCUITS

Pentodes or beam tubes like the T21 have proved to be the ideal for crystal oscillator use. For this service is required a tube that will give a lot of output with a small input, as the output of a crystal is limited, and the loading effect upon the crystal must be small. The power sensitivity of the T21 is very high, and because of its small plate to grid capacitance, the feedback is so small that the current in the crystal circuit is held down to a level that is not so likely to damage the crystal. The regular form of tetrode crystal oscillator circuit is shown in figure 15. This circuit gives a very good output when the plate circuit is tuned to the fundamental, with normal inputs, a T21 will give about 15 watts on the fundamental, and about 10 watts when doubling. The biasing resistance in the cathode circuit is sometimes omitted when low plate voltages are used, and the cathode tied directly to ground.

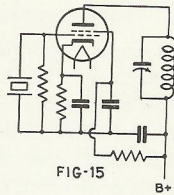

The regular tetrode oscillator shown in figure 15 can be improved by revising the circuit only slightly as shown in figure 16. With SW closed the operation is the same as in figure 15. With SW open the oscillator will furnish output on the second harmonic of the crystal, and improve the operation of sluggish inactive crystal on the fundamental. The only adjustment of importance is that of  $C_k$ . This should be checked each time that a different frequency band is used. The adjustment is simple, merely use a maximum of capacity that will allow good operation. If the capacity is too small the oscillator will be unstable and the crystal current very high. Normally the crystal current will be approximately 60 ma when doubling from 7 mc to 14mc. Closing SW keeps the crystal current at a minimum when operating straight thru.

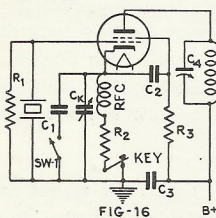

#### PARTS LIST

- C1, C2 .01 mfd. 400 Volt—paper
- C3 .01 mfd. 600 Volt—paper
- R1 50,000 ohm 1 watt
- R2 200 to 400 ohm 2 watt
- R3 10,000-25,000 ohm 2 watt
- SW—SPST toggle switch

The triode oscillator shown in figure 17, was designed to give a very high amount of harmonic output. However, it requires one more condenser and coil than the circuit of figure 15. In the triode, the cathode, control grid and screen grid behave almost like a triode oscillator, electron coupled to the plate of the tube. The use of the tuned circuit in the cathode circuit may give rise to large crystal current if the circuit is operated with the plate circuit tuned to the same frequency as the cathode tank, so the triode is usually used only for harmonic generation. Additional details on these circuits can be found in the handbooks, and various modifications of them are used in the transmitter circuits listed in this catalog, with values of circuit elements given.

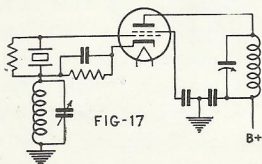

### CLASS B AMPLIFIERS

A class B amplifier is one in which the tube is biased at cut-off. It is generally used with push-pull amplifiers where the even harmonics will be balanced out, and when a sine wave signal is to be amplified, one tube will amplify the positive peaks, while the other will amplify the negative peaks, and if the tube characteristics are linear, the

resulting signal will be the exact duplicate of the original. Thus it can be used for straight audio amplification, or can be used to amplify radio frequency signals after they have been modulated. In this latter use they are sometimes referred to as "linear amplifiers". The class C amplifier can not be used for this purpose because the plate current flows in short pulses that are a very distorted image of the original RF signal, and requires the tuned plate circuit to restore the signal to its original form. Because it is quite a complicated procedure to get a class B RF amplifier to operate with high efficiency, it is seldom used in amateur work. The theoretical maximum efficiency of a class B amplifier is about 79%, but this is never realized in practice. In fact, efficiencies of 50% to 65% for audio and about 35% for RF are more common. While this compared unfavorably with the average of about 75% for the class C amplifier, for audio work it is way ahead of the 20% or 25% efficiency of the ordinary class A amplifier operating with a grid bias less than the cut-off value. The most important amateur use of the class B amplifier then, is in audio work, in the final stage of the modulator, where an efficient audio power amplifier is needed, usually to plate modulate a class C final amplifier.

Fortunately, the design and construction of a class B amplifier is a very simple problem. The tube manufacturers have cooperated by marketing tubes with high mu which have their cut-off when the grid is at zero voltage. This usually obviates the necessity of having a bias supply. The transformer manufacturers have cooperated by listing their class B input and output (Modulation) transformers in their catalogs stating just what tubes each transformer is designed to operate with. The class B push-pull modulation circuit is shown in figure 18. All that is needed is a pair of zero bias, or high mu tubes, a power supply, and an input and an output transformer. Since the grids of the class B tubes are at zero bias, when the audio driving voltage is applied, the grids will alternately go positive. This means that they will draw grid current and will absorb power from the driver

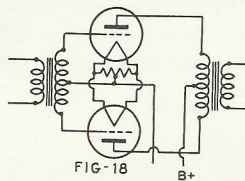

stage. So it is necessary to have a driver stage for a class B amplifier that will supply the necessary power. The amount required, is given in the class B tube characteristics sheet. The best driving circuit is push-pull 2A3s. These tubes are capable of an output of 15 watts, which is usually sufficient to drive a class B amplifier with an output of at least 500 watts, which is enough to fully modulate a kilowatt input to a class C amplifier. The input transformer is then found that will match 2A3 plates to TZ40 grids, for example. It will be listed in the catalogs in just that fashion. The tube manufacturer will probably specify the plate to plate impedance of the tubes, and this must be matched by the output or modulation transformer to the load presented by the class C stage being modulated. However, here again the transformer manufacturer lists the modulation transformers as being for use from TZ40s to such-and-such a load impedance. This load impedance is the class C DC plate voltage divided by the class C DC plate current. Thus if we have TZ40s modulating T40s drawing 230 mls at 1000 volts, the load that the TZ40s will be working into will be

$$\frac{1000}{.23} = 4,350 \text{ ohms. The transformer then must match the plate-}$$

to-plate load of the TZ40s (which will be about 16,000 ohms if they too are operating with 1000 volts on their plates) to this class C load of 4,350 ohms. In the transformer catalog a transformer will be found listed to match TZ40s to 4,500 ohms, probably, which is close enough. In case the class B stage is likely to be used to modulate different amplifiers, it will probably be a worthwhile purchase to get one of the modulation transformers which have variable taps on their secondaries so that any impedance can be matched. This will cost slightly more than the ordinary transformer, but might save the cost of a new one later on, if the modulated stage is changed.

As mentioned in an earlier section, most zero bias tubes have a small amount of plate current still flowing when the grid is at zero



potential. In the larger tubes with high plate voltages this may be large enough to make it desirable to have a slight negative bias of 10 or 20 volts applied to the grids to reduce this. A battery is the most common way of supplying this. It will be seen that the plate current in a class B amplifier will rise and fall as the audio signal is applied to the grid, this makes a very irregular load on the power supply, and therefore the class B power supply should have good regulation. That is, the voltage should remain relatively constant as the load changes. However, because, of the balanced arrangement of the circuit, the power supply need not be so free from hum as for other uses, a good deal of the hum being cancelled out in the output circuit, particularly if the tubes are well matched. High powered class B stages sometimes have a tendency to oscillate. This tendency can be eliminated by placing about a 100 ohm resistance in each plate lead.

### MERCURY VAPOR RECTIFIER TUBES

One of the most important things that has been done to bring the cost of transmitters down within the reach of the average amateur has been the development of the efficient and now inexpensive mercury vapor rectifier tube for high voltage power supplies. The outstanding feature of the mercury vapor tubes as compared to high vacuum rectifiers is their low internal voltage drop. The ionizational potential of mercury is about 15 volts with the result that the voltage drop in a mercury vapor rectifier tube of almost any description is 15 volts, no matter what the load current is. This makes for a minimum of voltage loss within the power supply itself.

There are two important characteristics of mercury vapor tubes that must be considered when making a selection for some particular application. The two things which limit the tubes operation are the peak inverse voltage rating and the peak current rating.

The meaning of the peak inverse voltage rating can be obtained from an examination of the figure 19. This shows two tubes connected in a full wave rectifier circuit. At some given instant the alternating voltage across the power transformer secondary makes point A positive, and point B negative. Under these conditions tube 1 will conduct, since its plate is positive, and will have a voltage drop across it of about

15 volts. It will be seen then that the voltage appearing across from plate to cathode of tube 2 is the **total** secondary voltage of the transformer, minus the 15 volt drop in tube 1 which can usually be neglected. Now suppose this power transformer had 1000 volts either side of the center-tap. The total voltage measured across the secondary by a voltmeter would be 2000 volts. But this is the so-called RMS value of the sine wave voltage, and its **peak** value, which is the maximum that tube 2 will have to stand, is always 1.4 times the RMS value, or in this case 2,800 volts. If tube 2 is not designed to stand this voltage it will break down, causing what is known as an "arc-back". An arc-back may be severe enough to destroy the tube. For safety the peak inverse voltage rating on the tube should be somewhat greater than the calculated maximum inverse peak that is expected.

The life of the tube to a great extent is dependent upon the current drawn from the filament. Sudden surges which cause abnormally high peak currents to flow will cause damage to the filament which will result in shorter life. The surges that comes from overloads can not be accurately computed, but the most likely cause for trouble if the tube is being operated too near its maximum peak current rating, comes from condenser input power supply filters. When the condenser input filter is used, the first condenser is connected across the tubes, from cathode to plate center-tap. Every cycle this condenser recharges with a sudden sharp current pulse which may be many times the steady value of load current. When a choke input filter is used the choke tends to iron out the current pulses, as it tries to hold the current constant, and the peak rectifier current will be little larger than the

steady value. Thus we see that condenser input filters should not be used when the rectifier tubes are operated near their maximum ratings, and for better tube life the choke input filter is preferred. When a heavy overload is thrown on a high vacuum rectifier, its voltage drop increases and it thus tends to take care of itself. The constant drop in the mercury vapor tube, however, does not change, and care should be taken that these tubes are not overloaded.

If the current carrying capacity of a single tube is not enough, tubes can be paralleled as shown in figure 20. The resistors placed in the

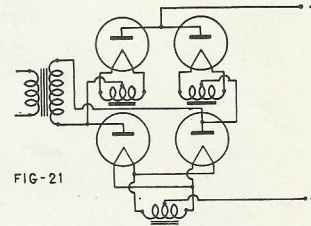
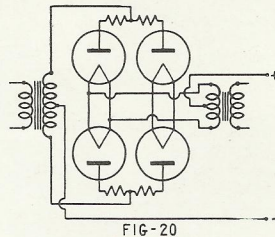

plate leads are necessary to make sure that the paralleled tubes will divide the load equally. The resistances should be large enough to have a drop of about 6 volts at full load current.

In figure 21 is shown a so-called bridge rectifier. Here three separate filament transformers are needed but the plate transformer need not have a center tap. The DC output voltage will be twice and the current  $\frac{1}{2}$  that expected from the same transformer with a center tap and connected as in figure 19. The DC voltage after the filter of a single phase full wave rectifier with choke input, is approximately 85% of the input voltage. In figure 19 the input voltage is considered as  $\frac{1}{2}$  the total secondary voltage and in figure 21 the input voltage is the secondary voltage.

The design of filters to go with high voltage power supplies is well covered in the various handbooks, and the transformer manufacturers' catalogs. Actual circuits can be taken from the power supplies shown with the transmitters in this book, providing the current and voltage rating fit your particular requirements. A list of parts accompanies each diagram for your convenience.

### TRANSMITTER CIRCUITS, DESIGNS AND PARTS

The purpose of publishing the Taylor Tube Manual is to give to the users full technical information on our complete line of Tubes together with correctly designed, thoroughly tested Transmitter circuits in which the tubes can be successfully used. The transmitters shown in this Manual are, therefore, models built up for test and photographic purposes and, with the exception of the chassis deal on the 275 Watt De Luxe Dual Unit Rig, no drilled chassis, templates or kits of parts are available. We give complete building instructions and use large size illustrations in this Manual to make the construction of these units a simple matter. If in constructing any of these units you experience any difficulty, you can secure technical assistance from any Taylor Tube Distributor or from us. Every transmitter shown has been completely "QSO Tested" on the air on all its operating frequencies. Many hundreds of amateurs built Taylor Tube transmitters from our last Manual and the many letters of praise we have received testify to their successful operation.

The use of any manufacturer's parts in any of the Transmitters does not imply that they must definitely be used. In variable condensers, you have Bud, Cardwell, Hammarlund, E. F. Johnson, National and Millen to choose from and they are all good. The same holds true for transformers and chokes. All of the standard lines such as Inca, Kenyon, Stancor, Thordarson and UTC can be used in Taylor Tube Transmitters with equal success. Metalware used is Bud's which is the line carried in stock by most distributors. We know that you are always safe in taking your distributor's recommendations on parts but we do urge that parts of equal quality be used if you want maximum performance from any transmitter.



# Taylor

CUSTOM  
BUILT

# Tubes

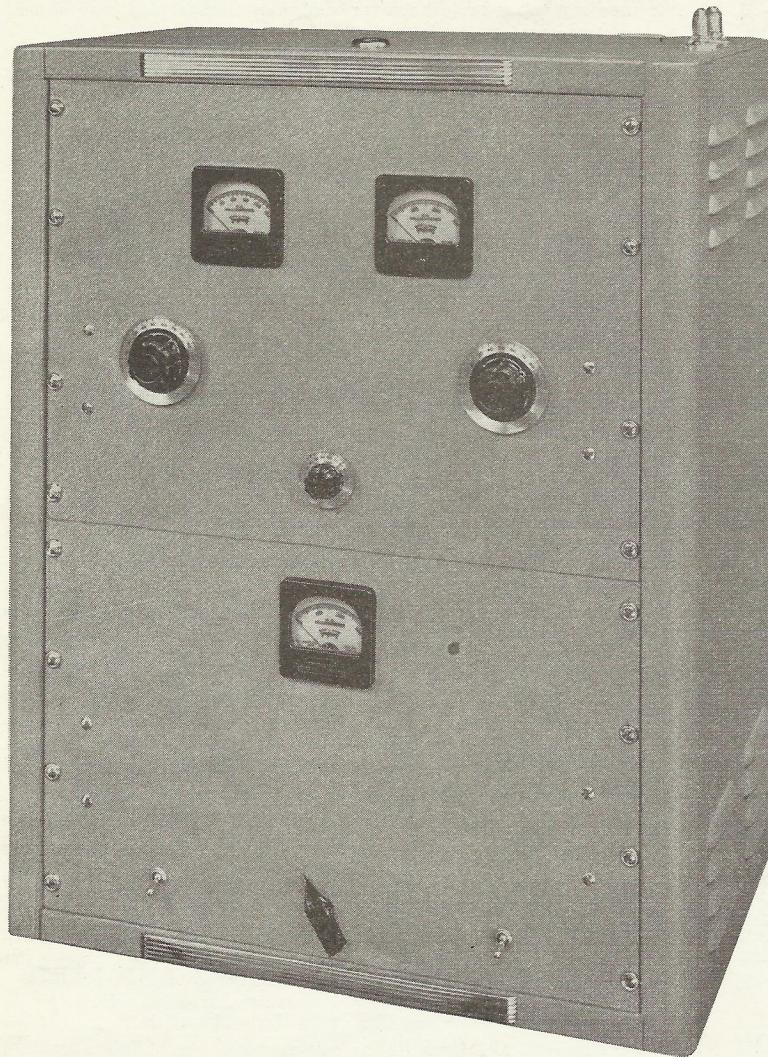

## 175 WATT

PHONE AND CW

Compact—Modern

Completely Self-Contained

TRANSMITTER

Can Be Built for

## \$1.00 Per Watt

10 TO 160 METER OPERATION

This Transmitter was described  
in the Feb. 1940 issue of Radio

This fine Transmitter is the 1940 version of the famous Taylor 150 watt Transmitters of previous Taylor Manuals. Hundreds of the former Transmitters were built and we have received a great many enthusiastic letters praising their operation. Parts of the best quality were used and still you can purchase everything needed including the Deluxe Bud Cabinet, Tubes and a Crystal for less than \$175.00. The speech amplifier and modulator are enclosed in the Unit as are all power supplies and switches. We recommend this Transmitter design highly and know that you will be pleased with its operation.

### CONSTRUCTIONAL DATA

This modernly designed transmitter was constructed with the idea that it must be compact, self contained, neat appearing and, last but not least, economical to build. The uniform design of the Kenyon Transformers throughout adds to the "Commercial" appearance of this rig. The entire Amateur cost will be not more than \$175.00, including everything—cabinet, tubes, crystals, coils, etc. Bud metal-ware was used entirely. It fills the bill for the amateur who has limited operating space and desires a moderate power transmitter.

The RF line-up is an old standby. It has been one of the most popular circuits presented in the past Taylor Manuals. It has again been revamped and now incorporates some of the new apparatus that became available during the past year. Several hundred of the earlier rigs have been built and are giving very enjoyable results.

The oscillator uses a T-21 operating either at crystal frequency or double crystal frequency, a tri-tet circuit being used for the harmonic output. By keeping the plate voltage below 300 volts and the screen voltage below 150 volts the crystal current is low enough to prevent crystal heating. No tuning controls are brought out for the crystal stage as once the tank circuits are adjusted for a particular band they require little attention thereafter. Hammarlund type SWF coil forms

are used which have provision for mounting a small tuning condenser inside them. The condensers used are type APC-50. A fixed capacity of 100 mmf is permanently connected across the cathode coil socket, eliminating the need for more than a 50 mmf tuning condenser in each cathode coil. The following stage is a TZ-40 used as a buffer-doubler and operated at reduced power, since it is only required to drive a single T-55 in the final. The plate coil of the TZ-40 is link coupled to the grid coil of the final. National 50 watt coils are used on both cases, center link for the plate and end link for the grid coil. The final amplifier uses a Cardwell type AFU foundation unit which consists of a MT-100-GD tuning condenser, two neutralizing condensers, and two brackets on which are mounted the B & W BVL swinging link unit. Since the final amplifier is single ended only one neutralizing condenser is needed, the extra one is used for the buffer doubler stage. The tuning condenser will cover the 10 to 80 meter bands inclusive with appropriate B & W type B coils, and if 160 meter operation is desired it is only necessary to plug in a 100 mmf fixed condenser which is connected across the two stators of the tuning condenser. A Bud type FA781 is used for this purpose. Note that the plate voltage is connected directly to the frame of the condenser which makes it necessary to insulate it quite well from the chassis.



"\$1.00 PER WATT" 175 WATT TRANSMITTER

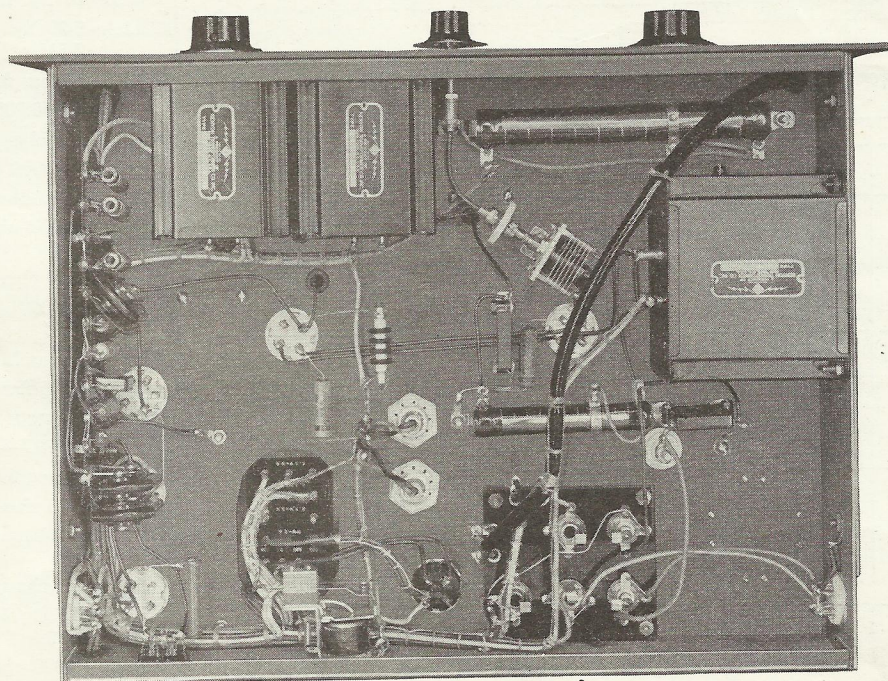
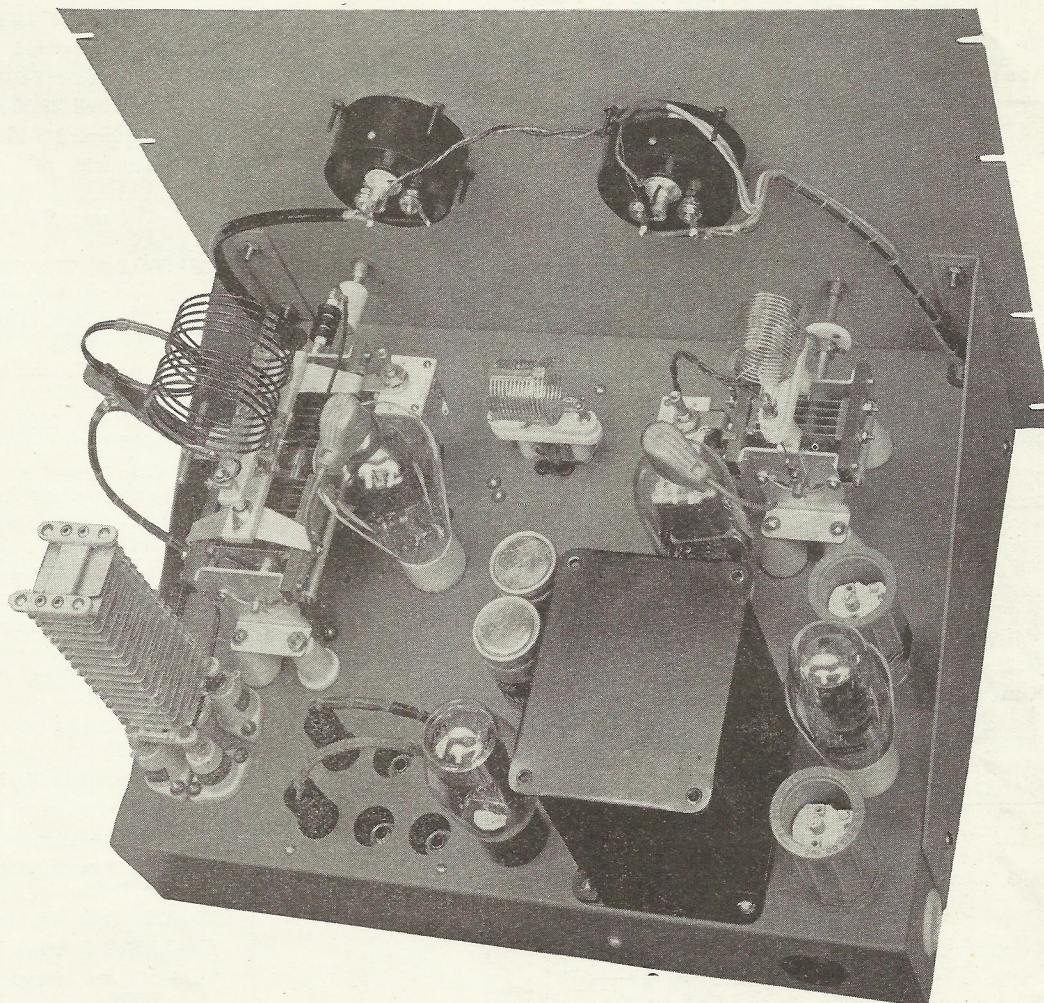



# "\$1.00 PER WATT" 175 WATT TRANSMITTER

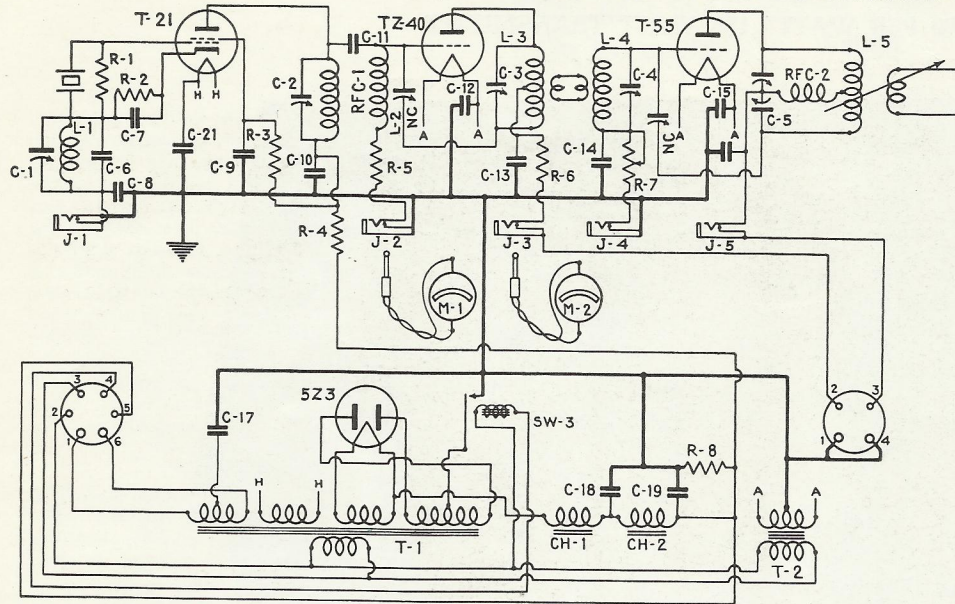

R. F. and Low Voltage Power Supply Diagram

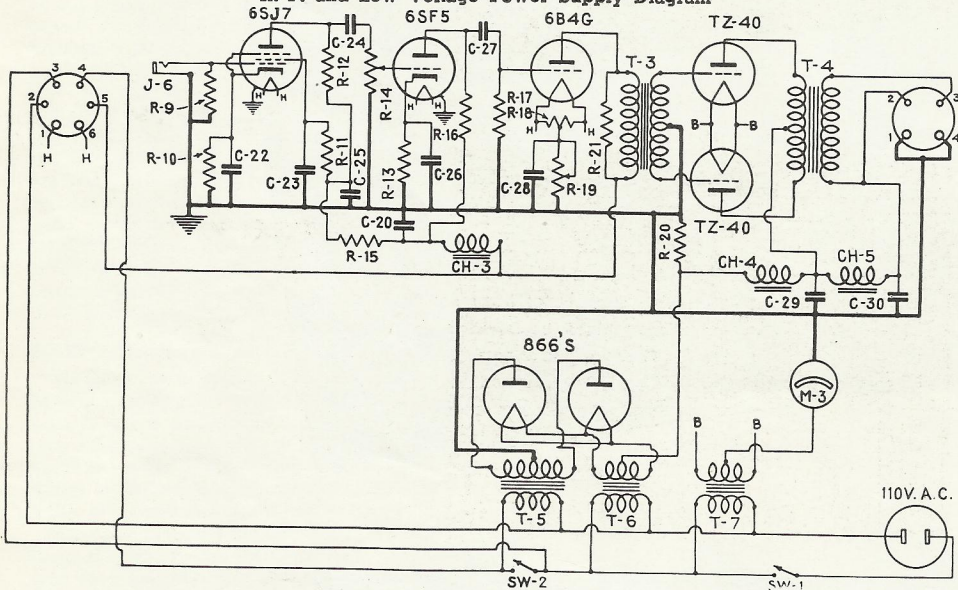

Modulator, Speech Amp. and High Voltage Power Supply Diagram

## COIL CHART

BAND	L <sub>1</sub>	L <sub>2</sub>	L <sub>3</sub>	L <sub>4</sub>	L <sub>5</sub>
10 Meters			National 10 C	National 10 E	B & W 10 BVL
20 Meters		7 turns #22 enameled double spaced Hammarlund Type SWF 5 form	National 20 C	National 20 E	B & W 20 BVL
40 Meters	5 turns #22 enameled close wound Hammarlund Type SWF 4 form	14 turns #22 enameled close wound Hammarlund Type SWF 5 form	National 40 C	National 40 E	B & W 40 BVL
80 Meters	15 turns #22 enameled close wound Hammarlund Type SWF 4 form	30 turns #22 enameled close wound Hammarlund Type SWF 5 form	National 80 C	National 40 E	B & W 80 BVL
160 Meters	50 turns #22 enameled close wound Hammarlund Type SWF 4 form	80 turns #22 enameled close wound Hammarlund Type SWF 5 form	National 160 C	National 160 E	B & W 160 BVL plus Bud fixed air condenser #FA 781

## PARTS LIST

- NC—Cardwell ZS-7-SS
- C1, C2—Hammarlund, APC-50
- C3—Cardwell MT-50-GS
- C4—Cardwell ZR-50-AS
- C5—Cardwell MT-100-GD
- C6—.001 mfd. 1200 volt mica C-D No. 4-12T1
- C7—.001 mfd. 600 volt mica C-D No. 1W-5D1
- C8, C9, C10, C12, C15, C17, C21, C24, C27—.01 mfd. C-D No. DT651
- C11—.00005 mfd. 1200 volt mica C-D No. 4-12Q5
- C13, C14—.001 mfd. 1200 volt mica C-D No. 4-12D1
- C16—.001 mfd. 2500 volt mica C-D No. 4-25D1
- C18, C19, C20—8 mfd. electrolytic 600 volts working Aerovox GL-600
- C22, C26—5 mfd. 25 volt electrolytic C-D No. ED2050
- C23—.05 mfd. 600 volt paper C-D No. 5M-6S5
- C25—8 mfd. electrolytic 425 volt C-D No. ED9080
- C28—25 mfd. 50 volt electrolytic C-D No. ED3250
- C29, C30—2 mfd. 1500 volt oil C-D TJU-15020
- T1—400 volt 200 Ma Kenyon T-213
- T2—7.5 Volt 8 Amps. Kenyon T-359
- T3—Driver transformer, Kenyon T-253
- T4—Class B modulation transformer, Kenyon T-495
- T5—1250 Volts 500 Ma. Kenyon T-671
- T7—7.5 Volt 8 Amps. Kenyon T-359
- Ch1—5-20 hy. swinging choke, Kenyon T-506
- Ch2—10 hy. filter choke, Kenyon T-152
- Ch3—20 hy. filter choke, Kenyon T-157
- Ch4—5-20 hy. swinging choke, Kenyon T-516
- Ch5—10 hy. filter choke, Kenyon T-152
- R1, R15—50,000 ohm one watt
- R2—200 ohm 10 watt Ohmite
- R3, R5—10000 ohm 10 watt Ohmite
- R4—5,000 ohm 20 watt Ohmite
- R6—10,000 ohm 100 watt Ohmite No. 0965
- R7—7500 ohm 50 watt Ohmite No. 0579
- R8—50,000 ohm 50 watt Ohmite No. 0588
- R9—5 megohm 1 watt
- R10—1700 ohm 1 watt
- R11—2.5 megohm 1 watt
- R12, R16, R17—.5 megohm 1 watt
- R13—.5 megohm potentiometer IRC
- R14—4500 ohm 1 watt
- R18—50 ohm center tapped, Ohmite, 1 watt
- R19—800 ohm 25 watt Ohmite No. 0374
- R20—50,000 ohm 75 watt Ohmite No. 0793
- R21—10,000 ohm Ohmite 10 watt
- M1—O-150 Triplett No. 227A
- M2, M3—O-300 Triplett No. 227A



## "\$1.00 PER WATT" 175 WATT TRANSMITTER



TOP VIEW  
SPEECH AMPLIFIER,  
MODULATOR  
AND HIGH VOLTAGE  
POWER SUPPLY

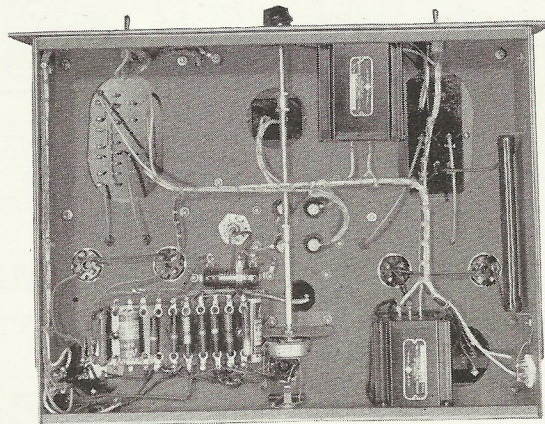

BOTTOM VIEW

### CONSTRUCTIONAL DATA—Continued

This connection reduces the voltage across the condenser by approximately half and makes it possible to use a much smaller unit. Metering on the RF section is done with only two meters. Five closed circuit jacks are mounted on a small bakelite panel under the chassis and so connected to measure oscillator, buffer and final amplifier plate current, buffer and final amplifier grid current. Once the transmitter is adjusted the meters are plugged into the final amplifier plate and grid current jacks. Any change in the performance of the transmitter will usually be reflected in these meters. The RF section is mounted on a standard 17"x13"x3" chassis which also contains the low voltage power supply for the crystal oscillator and speech amplifier.

The other chassis contains the speech amplifier, modulator and high voltage power supplies. The high voltage power supply delivers 1250 volts to the final amplifier, modulator and to the buffer through a series resistor. The modulator is operated at zero bias and with no signal input the plate dissipation is approximately 42 watts per tube. With signal input the plate efficiency of the modulator improves so that the average plate dissipation is less than the rated 40 watts. In order to conserve space and keep the cost as low as possible a very simple speech amplifier was used. The class B driver tube is a single 6B4G. Ordinarily a single ended class B driver tube is to be scorned, however in this case where the plate voltage is quite high for the required audio power it is possible to select a plate to plate load that will give very satisfactory operation. A load of 14000 ohms

plate to plate is the best load in this case, and a check with oscilloscope shows good wave form up to 100 percent modulation. The fore part of the speech amplifier consists of a 6SJ7 and a 6SF5 tube. The amplifier is conventional except for the use of the new single ended tubes. In assembling the amplifier a pre assembly was made containing all resistors and condensers. It is a simple matter then to make the few remaining connection to the tube sockets. There was some doubt as to the feasibility of mounting the speech amplifier on the same chassis as the high voltage power supply and in the same cabinet as the RF portion of the transmitter. The power supply caused no trouble at all. Some RF feed back was experienced on 10 and 20 meters when the audio gain control was in excess of three quarters open. It was found that the shell of the 6SJ7 tube was not acting as a good shield and when touched violent feed back would result although the No. 1 socket pin was properly grounded. A Voltmeter revealed approximately .25 ohms resistance between the shell and the No. 1 pin. A small wire soldered from the pin to the shell completely cured all the feed back. We are advised that this resistance is in most of the metal tubes for the purpose of getting flashing and is occasionally responsible for instability in high gain audio and RF stages.

The transmitter operates on all bands with an input of 175 to 200 watts and will deliver an output of approximately 75 per cent of the plate input.



# Taylor Tubes

## FIELD DAY—EMERGENCY DUO-POWER TRANSMITTER

Compact—Phone and C.W.

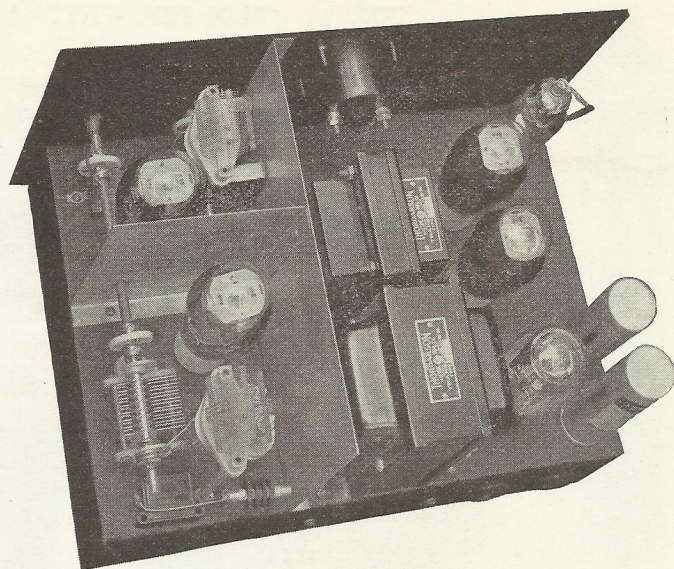

This Transmitter was given a thorough trial during the 1939 ARRL Field Day contest and worked out most efficiently. The keying action was clean-cut and did not bother the reception of signals on adjacent bands. The reports on the Phone quality were pleasing and the ease of operation enabled the operators to make many contacts on 20 meter Phone and C. W.

The T-21 tube offers many possibilities for portable and mobile transmitters. Described here is a tried and proven telephone and telegraph transmitter using T-21 tubes, suitable for portable operation. The transmitter is self contained for 110 AC operation and if 6V battery operation is desired a connection is provided for a vibrapack. A Mallory Dual vibrapack No. VP557 is recommended for battery operation.

The RF portion of the transmitter consists of a T-21 oscillator operated at reduced input and a T-21 class C final amplifier or doubler. The oscillator is of the regenerative type, (see new and even better regenerative oscillator fig. 16, page 26) so it is possible to use one crystal for more than one band. The final amplifier can be either a doubler or amplifier on 20, 40, 80 meter and on 10 meters it is used as a doubler only. The output on 10 meters is approximately 10 Watts and the other bands approximately 15 Watts. The modulator uses 2 T-21 tubes in push-pull class A which will furnish more than enough power for full modulation. Push-pull is used to secure good quality transmission, however, one tube can be used with good success if it is desired to save part of the current drain when operating from a battery. When one tube is used the entire grid winding of the input transformer should be used for one tube, and the output transformer reconnected for a turn ratio of approximately 1 to 1.2.

The speech amplifier consists of a single dual triode, type 6C8G connected in cascade. This provides enough gain for a crystal mike such as a Turner V73 and others with comparatively high output. The circuit is conventional and the only difficulty encountered was a trace of RF feed back. This was traced to the common filament winding and eliminated by a by pass condenser at the Heater connection of the 6C8G socket.

The entire transmitter is housed in a Bud C-975A steel cabinet and mounted on a Bud CB-34 chassis. The shields between the RF section and the modulator are Bud IS1246 and 1247. Only one meter is needed which measures the plate current on either oscillator or final amplifier. Keying is accomplished by opening the cathode circuits of both RF tubes.

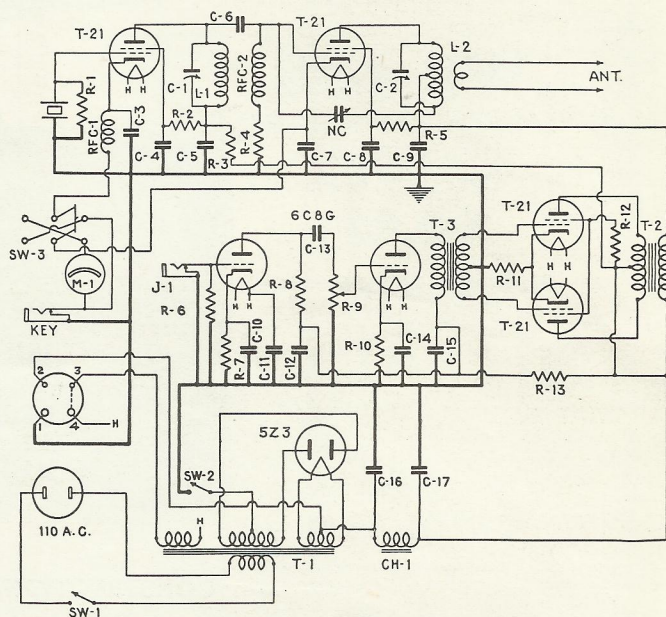

### PARTS LIST

C-1	50 mmf. Bud No. MC903	R-3	10,000 ohm 10 Watt, Ohmite
C-2	50 mmf. Bud No. MC898	R-4	10,000 ohm 2 Watt, IRC
C-3	.0001 1000 Volt mica, C-D	R-5	10,000 ohm 10 Watt, Ohmite
C-4	.01 600 Volt paper, C-D	R-6	5 megohms 1/2 Watt, IRC
C-5	.01 600 Volt paper, C-D	R-7, R-10	1500 ohm 1 Watt, IRC
C-6	.00005 1000 Volt mica, C-D	R-8	50,000 2 Watt, IRC
C-7	.01 600 Volt paper, C-D	R-9	500,000 ohm Volume control, Yaxley
C-8	.01 600 Volt paper, C-D	R-11	200 ohm 10 watt, Ohmite
C-9	.001 1000 Volt mica, C-D	R-12	25,000 ohm 10 Watt, Ohmite
C-10	5 mfd. 25 Volt electrolytic, C-D	R-13	10,000 ohm 10 Watt, Ohmite
C-11	.01 400 Volt paper, C-D	M-1	0-150 MA Triplett No. 327A
C-12	.1 400 Volt paper, C-D	T-1	Thordarson 92R21 Plate and Fil. Trans.
C-13	.01 400 Volt paper, C-D	T-2	Thordarson 19M14 Modulation Trans.
C-14	5 mfd. 25 Volt electrolytic, C-D	T-3	Thordarson 13A35 Input Trans.
C-15-16-17	8 mfd. 450 Volt Electrolytic, C-D	CH-1	Thordarson 67C49 Filter Choke
NC	Bud NC 890 Neut. Cond.	L-1	B & W 10-20-40-80 Meter M Coils
R-1	5,000 ohm 1 Watt, IRC	L-2	B & W 10-20-40-80 Meter MCL Coils
R-2	10,000 ohm 2 Watt, IRC		



### MALLORY VIBRAPACK

**Perfect Portable Power.** This Vibrapack No. VP-557 is a dual unit that will deliver 150 MA. at 400 Volts D.C. Operates on 6 volt input.



# Taylor

## SAFETY KW TRANSMITTER

1000 WATTS INPUT  
PLATE MODULATED

10 TO 80 METER  
OPERATION

*Incorporates  
Every Practical  
Safety Device  
Plus  
Stancor Safety  
Transformers*

HIGH EFFICIENCY  
CIRCUIT  
USING  
TW-150's  
THIN WALL  
CARBON ANODE TUBES

This Transmitter was described  
in Dec. 1939 QST

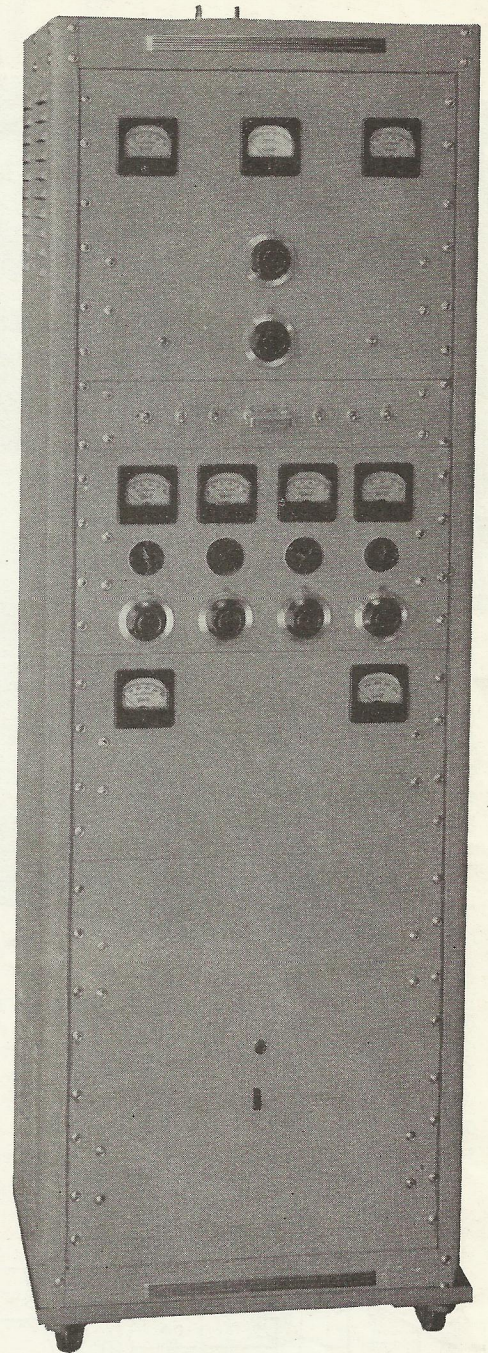
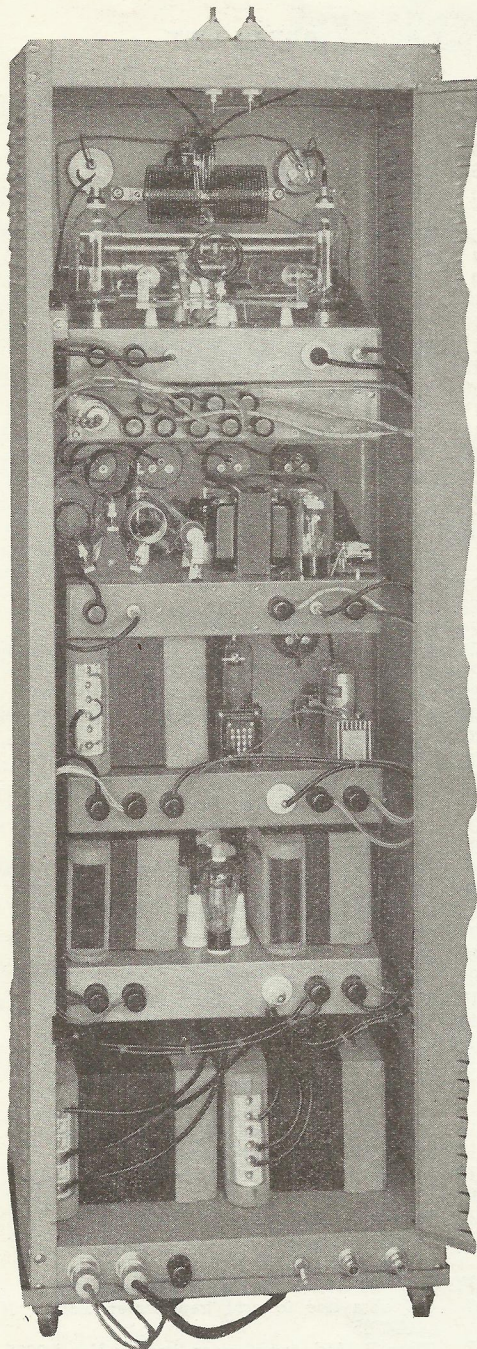

### CONSTRUCTIONAL DATA

Although the transmitter this is absolutely safe in the hands of a careless person has not been built as yet, certain steps can be taken to greatly improve the present practice in the construction of Amateur transmitters. One has only to read the past year's copies of QST to prove this point. The transmitter described here has been built with the express idea of seeing just what could be done with the equipment now available toward building a SAFE compact kilowatt. There are without doubt other precautions that could be incorporated, however, we believe the most important points have been protected with safety devices.

Of first importance is of course, the housing of the transmitter in a steel cabinet, and the door to the cabinet must be provided with an inter-lock switch so that on entering the transmitter the 110 AC line is opened. A Bud CR1772 Cabinet was chosen for the job as it has provision for door interlock switches built in. Another known potential hazard that exists in the majority of present day rack panel transmitters are the plate meters which are connected in the positive side of the high voltage line. From the beginning it was decided to place all meters in the negative lead and in so doing so surprisingly few

complications over the conventional system were encountered. In the T-21 oscillator and buffer doubler stages the meter was simply placed in the cathode circuit which is more or less conventional. This has a disadvantage in that the meter reads the total plate screen and control grid current. This can easily be overlooked, however, since the control grid current is small and the screen current is small when the plate current is increased upon loading. Resonance is indicated by a less pronounced dip in the current due to the screen current and control grid current rising as the plate current dips. In the case of the driver and final stages there were two possible methods that could be used. Fig. 1 shows a method which is the same as described above in the case of the oscillator and buffer doubler stages. This method reads both grid and plate current and was considered a disadvantage in the case of a triode since the grid current could so easily be removed from the plate meter by one change in the connection as shown in Fig. 1b. This method of metering not only makes the meter safe to the operator but also protects the meters from possible breakdown to ground which occasionally happens. The bleeder selected so as to be very conservative in the amount of power they actually dissipate in service with the idea of making them more dependable. 100 watts



# SAFETY KW TRANSMITTER

## PARTS LIST

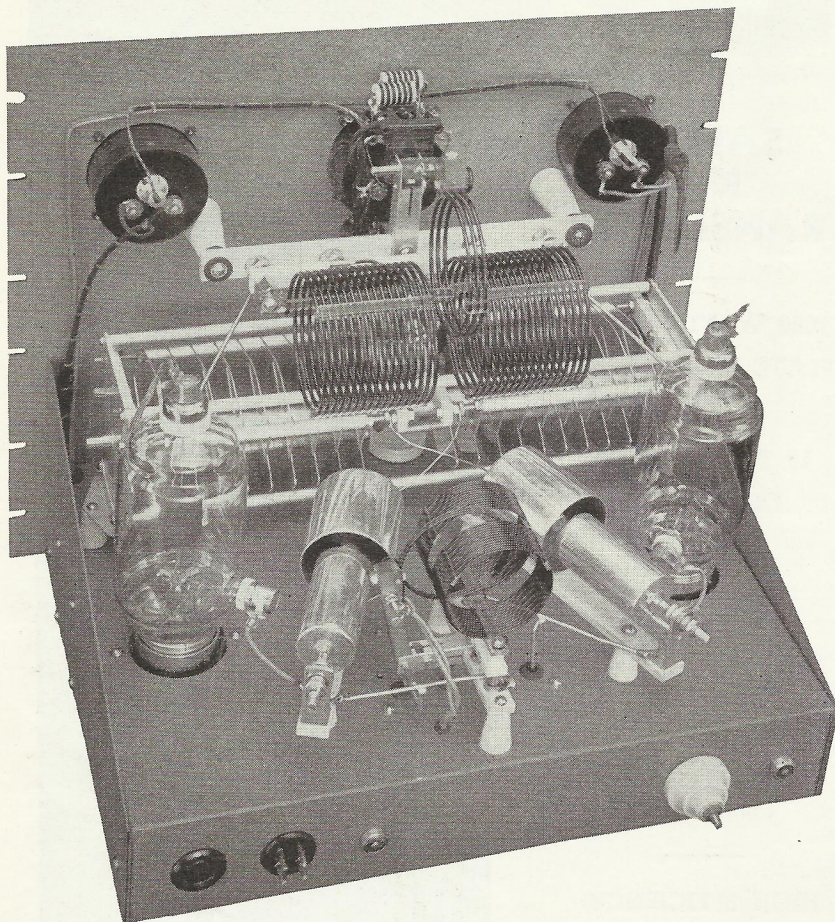

View of Safety KW Final Amplifier

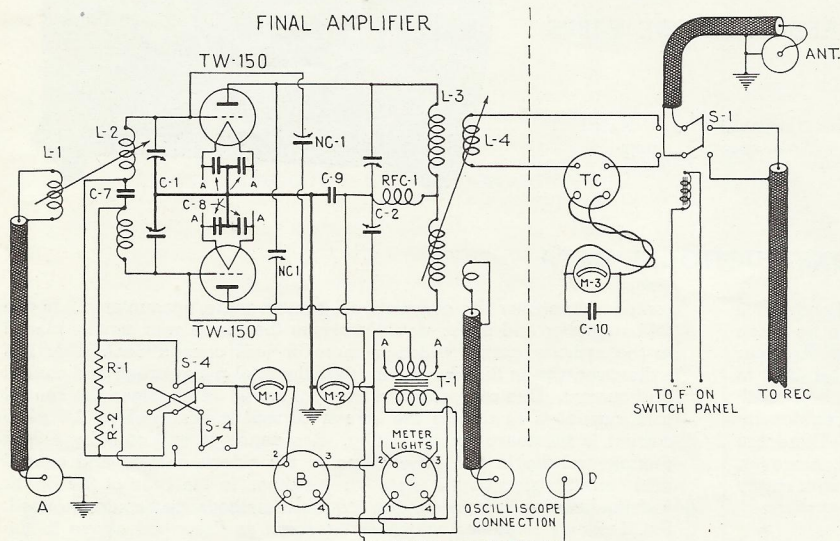

Diagram of Safety KW Final Amplifier

- C-1 Johnson 100DD20
- C-2 Johnson 100DD90
- C-3 Hammarlund APC-50
- C-4 Johnson 100F20
- C-5 Johnson 100F20
- C-6 Johnson 100DD30
- NC-1 Johnson N-375
- NC-2 Johnson N-125
- C-7 .002-1200V C-D 9-12D2
- C-8 .01-600V Paper C-D DT-6S1
- C-9 .002 12500V Mica C-D 22A-86
- C-10 .002 1200V Mica C-D 9-12D2
- C-11 .006 500V Mica C-D 1W-5D6
- C-12 .0001 1200V Mica C-D 9-12T1
- C-13 .001 600V Mica C-D 4-6D1
- C-14 .001 600V Mica C-D 4-6D1
- C-15 .00005 600V Mica C-D 4-6Q5
- C-16 .001 600V Mica C-D 4-6D1
- C-17 .001 600V Mica C-D 4-6D1
- C-18 .001 600V Mica C-D 4-6D1
- C-19 .00005 No. 4-6Q5 600V C-D
- C-20 .01 600V Paper C-D DT-6S1
- C-21 8 Mfd. Elec. C-D EY11081
- C-22 8 Mfd. Elec. C-D EY11081
- C-23 8 Mfd. Elec. C-D EB9080
- C-24 8 Mfd. Elec. C-D EB9080
- C-25 8 Mfd. Elec. C-D IR-208
- C-26 .001 Mfd. Mica 7000V C-D 21C-86
- C-27 4 Mfd. 2000V C-D TJ20040V
- C-28 4 Mfd. 3000V C-D TJ30040U
- RFC-1 Johnson No. 754
- RFC-2 Johnson No. 752
- RFC-3 Johnson No. 750
- R-1 100 ohm 1 Watt Ohmite
- R-2 100 ohm 1 Watt Ohmite
- R-3 50000 ohm 2 Watt IRC
- R-4 50000 ohm 20 Watt Ohmite
- R-5 50000 ohm 10 Watt Ohmite
- R-6 1000 ohm 10 Watt Ohmite
- R-7 2000 ohm 1 Watt IRC
- R-8 2000 ohm 50 Watt Ohmite No. 0574
- R-9 400 ohm 10 Watt Ohmite
- R-10 25000 ohm 50 Watt Ohmite No. 0585
- R-11 5000 ohm 25 Watt Ohmite No. 0382
- R-12 3500 ohm 75 Watt Ohmite No. 0783
- R-13 4 Meg.—Triplett Voltmeter multiplier
- R-14 10 Meg.—2 Watt IRC
- R-15 1 Meg.—2 Watt IRC
- R-16 30000 ohm 200 Watt Ohmite No. 0920
- R-17 75000 ohm 200 Watt Ohmite No. 0924
- R-18 Integral part of overload relay
- T-1 10V 8A Stancor P6139
- T-2 Stancor No. 6165 800V CT 200 MA  
5 V CT 4A  
6.3V CT 5.5A
- T-3 7.5V 4A & 6.3V 3A Stancor No. 4090
- T-4 500 ohm line to grid transformer Stancor No. A4765
- T-5 Class B Mod. transformer Stancor No. A8005
- T-6 Stancor No. P6002 700V CT 50MA  
5 V CT 2 A  
2.5V CT 7.5A
- T-7 10V 8A Stancor No. P6139
- T-8 2.5V 10A Stancor No. P3060
- T-9 1750V Transformer Stancor No. P8005
- T-10 2.5V 10A Stancor No. P3060
- T-11 3000V Transformer Stancor No. P8007
- T-12 6.3V 3A Stancor No. P5014
- CH-1 Stancor No. C-1410 Choke
- CH-2 Stancor No. C-1708 Choke
- CH-3 & Ch-4 No. C2313 Stancor Swinging Choke

### METERS

- M-1—0-150MA Triplett No. 327A
- M-2—0-500 Triplett No. 327A
- M-3—0-5A Triplett No. 327A
- M-4—0-100MA Triplett No. 327A
- M-5—0-100MA Triplett No. 327A
- M-6—0-50 Triplett No. 327A
- M-7—0-200MA Triplett No. 327A
- M-8—0-500MA Triplett No. 327A
- M-9—0-4000V DC volt meter No. 327A



# SAFETY KW TRANSMITTER

## PARTS LIST—Continued

### RELAYS

- S-1 Guardian Antenna Relay No. A-100
- S-2 Guardian Keying Relay No. K-100
- S-3 Guardian Relay R-100
- S-4 D. P. D. T. Toggle Switch
- S-5 S. P. D. T. Toggle Switch
- S-6 Guardian Relay R-100-B
- S-7 Guardian Overload Relay U-100
- S-8 Guardian Relay R-100-B
- S-9 Guardian Overload Relay No. X-100
- S-10 D. P. D. T. Switch H & H No. 8660
- S-11 Guardian Keying Relay K-100
- S-12-13-14-15-16-17-18-19—Heavy Duty D.P.S.T. Toggle Switch BUD SW-1269

**COIL CHART**  
at end of Article

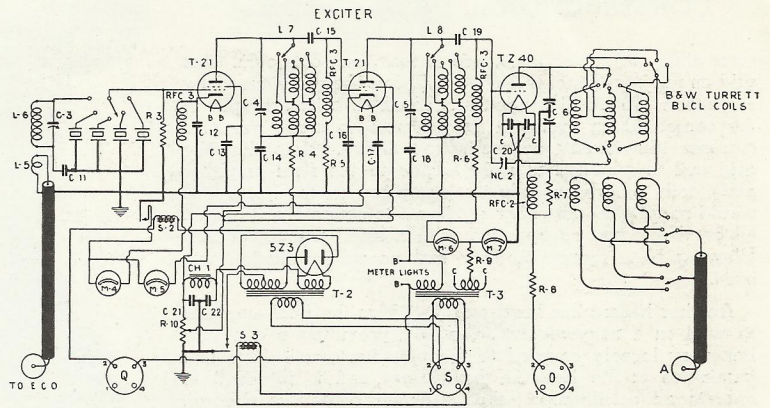

## CONSTRUCTIONAL DATA—Continued

is wasted in each bleeder and the resistors are rated at 200 watts each. Some allowance, however, must be made since the air circulation around the resistors mounted under chassis does not allow the maximum rating to be used with safety.

For the transmitter to be modern as well as safe, it was decided it must cover a frequency range of 3.5 Mc to 30 Mc. To accomplish this requires careful selection of the final amplifier tank condenser. The minimum capacity must be low enough for 10 meters and the maximum capacity must be sufficient for 80 meters. The spacing must be sufficient for 3000 volt 100 per cent modulated operation without flash-over, and it must still be mechanically small enough to mount suitably on a standard chassis pan. The condenser chosen was a Johnson 100DD90 which has a flash-over voltage per section of 9000 volts and is approximately 16½ inches long. The length automatically dictated that it be mounted parallel with the panel as the cabinet is only 16 inches deep. The condenser fitted beautifully along the front of the chassis but this presented an undesirable situation for tuning. Further investigation revealed that this condenser like most other makes of dual stator condensers could be driven from the center with suitable gears. The 100 DD 90 was partially dis-assembled and a miter gear was installed between the two rotors so that a like miter gear would drive the condenser at the exact center. The operation is not difficult and could be done with a hack saw, drill and a file if a lathe is not available. The gears required for this particular job were from the Boston Gear Company, catalogue No. G465 and cost about one dollar. A small bracket to hold the shaft of the driving gear was fastened to one of the tie rods and this bearing along with a standard panel bearing mounted in the front panel made a good substantial mechanical job. In order to use a 9000 volt condenser it is necessary to block off the dc from the rotor. This greatly increases the flash-over point of split stator condensers, the subject having been covered thoroughly by Ferrill in the December, 1938 issue of QST. This requires that the condenser be mounted on good standoff insulators and the tuning shaft be well insulated. One inch Steatite cones were used to mount the condenser, and the tuning shaft was insulated with a Johnson No. 252 rigid ceramic shaft coupling which was ideal for the job. The Barker & Williamson HDVL was mounted directly on the panel so that the coils plug in horizontally. This resulted in a saving of some height and gave short leads to the tank condenser. The Johnson N 375 neutralizing condensers were mounted horizontally in order to save some lead length and to facilitate adjustment. Another worthwhile feature of the final amplifier is the metering of the DC grid current. Either individual or collective readings can be had by proper arrangement of switches. This was considered important in that it is quite easy to have sufficient total grid current; but if it does not divide equally between the two tubes, poor performance may result. To prevent loss of bias during switching, 100 ohm one watt resistors are connected from each grid return to the positive side of the meter. The resistors are actually in shunt with the grid current meter but cause a negligible

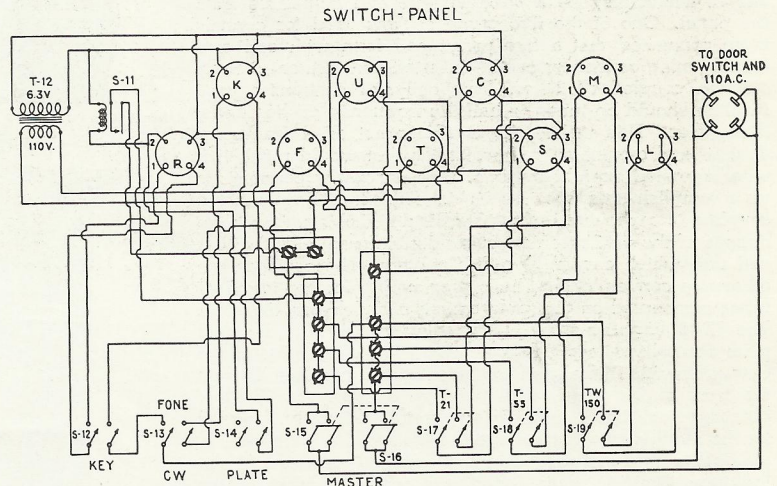

### MODULATOR & BIAS

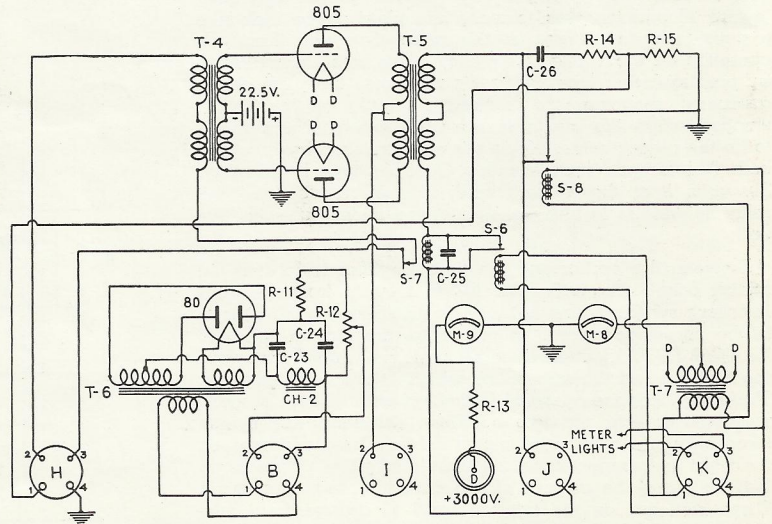



## SAFETY KW TRANSMITTER

### CONSTRUCTIONAL DATA—Continued

error since the meter resistance is less than one ohm. The grid circuit consists of a B & W BVL coil assembly tuned by a Johnson 100 DD20 condenser. The BVL coils are split in the center which makes it very simple to meter the grid currents individually as mentioned above. Note that the grid coil is mounted at right angles to the final amplifier plate coil; otherwise inductive coupling to the plate coil would result. The amplifier as shown is extremely stable on all bands. It can be operated with a small amount of bias allowing plate current to flow and no self oscillation will exist.

Another hazard has been removed from the final amplifier as well as a convenience added by providing a one turn link very loosely coupled to the plate tank coil. This link terminates at the base of the cabinet and is intended to operate an oscilloscope when a wave pattern is desired. One side is grounded eliminating any danger of the operator coming in contact with the tank coil via the oscilloscope pick up.

The exciter consists of a T-21 oscillator, T-21 buffer-doubler, and a TZ-40 amplifier, and is band-switching from the front of the panel. Provision has been made for five crystals, one of which may be a variable type and adjustable from the panel. One of the five prong sockets used for crystals is so connected that a five prong coil form with self contained tuning condenser can be inserted and connected to an electron coupled oscillator. This coil and condenser combination should be tuned to half the frequency of the crystal it replaces. This makes the oscillator act as a frequency doubler and eliminates self oscillation that would result if it were operated straight through. The necessary connections to accomplish this are shown in Fig. 2. All inter-stage coupling is capacitive to facilitate band switching. The plate circuits of the oscillator and buffer-doubler use a Bud OSC-1 coil unit which covers 10 to 160 meters. These stages are otherwise conventional. The power supply for the two T-21 tubes is mounted on the same chassis and delivers 400 volts. The TZ-40 amplifier stage is connected as a balanced output plate neutralized amplifier and uses a B & W Turret in the output circuit. This allows the selection of three bands from the front of the panel. The plate voltage for the TZ-40 is obtained from the 1750 volt power supply primarily intended for the modulator. This voltage is reduced to a more reasonable value by a series resistor and a cathode resistor. When the transmitter is being keyed, the resting current of the high mu TZ-40 with the bias secured from the cathode resistor limits the plate dissipation to about 30 watts. This eliminates the use of a well-regulated bias supply since the bias supply is needed only for the final amplifier. Note that the TZ-40 operates with an RF choke in the plate and grid circuits which caused the usual trouble of low frequency parasitic oscillation. The plate choke becomes a low frequency tank circuit and the grid choke allows sufficient excitation voltage to build up and start a weak oscillation. This type of parasitic is only troublesome when the excitation is removed, as in keying; so the proper approach toward elimination was to make the plate choke look like a poor tank circuit and at the same time not affect the operation on the wanted frequency. This was accomplished by placing carbon one watt resistors across the plate choke gradually reducing the resistance until the oscillation stopped when the key was open. 2000 ohms was found to be the proper value. Keying is accomplished by breaking both T-21 cathode circuits with a Guardian type K-100 relay. Six volts from the heater circuit is used to energize the relay as well as furnish voltage for the meter lights on this unit.

Between the exciter and the final amplifier is located the switch panel. The 110 volts AC is brought from the door inter-lock switch to this unit and is distributed to all chassis in the proper sequence. In the center are located two Bud No. 1269 DPST 10 ampere toggle switches which must carry the total load of the transmitter which is about 20 amperes. These switches are operated in tandem with a block of metal machined to join the two handles. Throwing this switch turns on all filaments and meter lights. Three switches on the right are connected in the individual plate primaries so that they may be cut out of the circuit during adjustment. Three switches on the left are used to change from telephone to telegraph, close the keying relay locally, and to operate the plate primary relay locally. Multiple connections

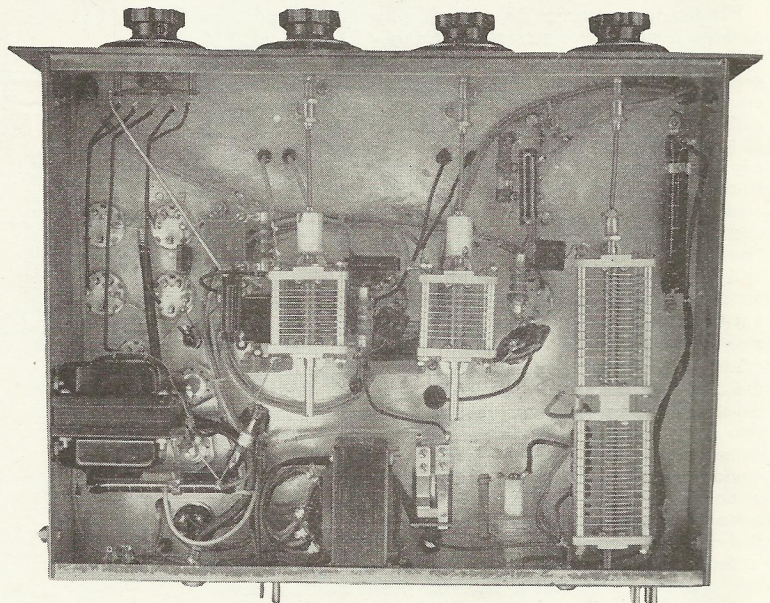
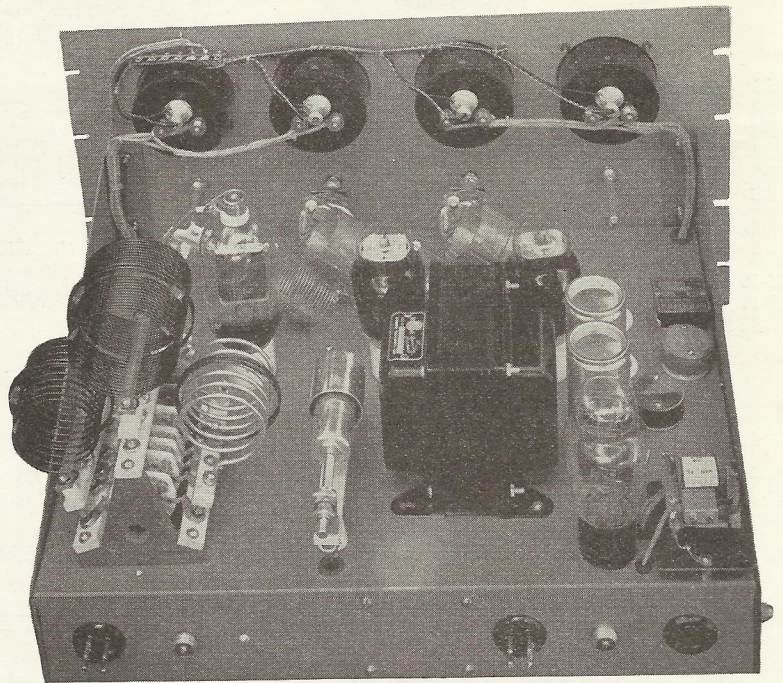

HIGH VOLTAGE POWER SUPPLIES

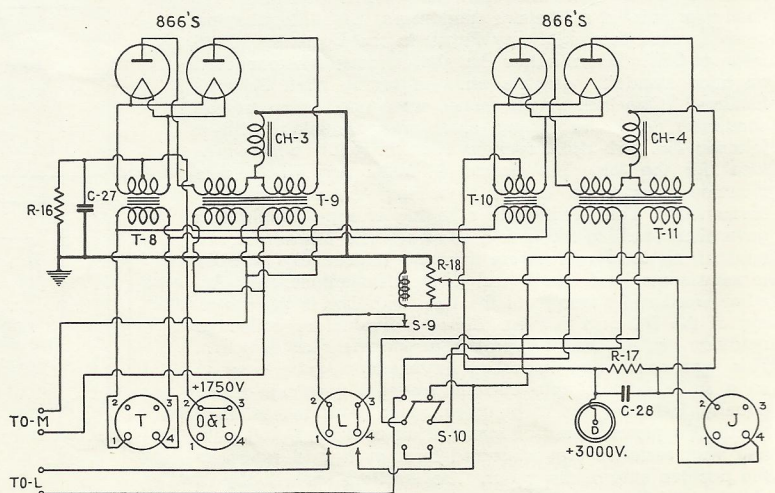



## SAFETY KW TRANSMITTER

of the latter two appear at the base of the transmitter for remote operation. All wiring in the switching unit terminates in nine four-prong Amphenol Bakelite sockets and an Amphenol 92-C1 receptacle. The plate primary relay, Guardian K-100 and the meter light transformer is also located in this unit.

A pair of 805's are used for the modulator. Experience has proven that they can modulate 1000 watts input very nicely provided voice only is used, and that the plate to plate load is made slightly lower than normal. 1750 volts are needed to develop the necessary power and that at this voltage 22½ volts of bias are required. It was debated whether to install a bias regulator or use battery bias here and the battery won out due to its simplicity and long life in this type of service. Input to the modulator is through the 500 ohm line to grid transformer. The modulation transformer is connected in the negative lead instead of the conventional positive lead. This was done in order to use an inexpensive relay to short circuit the secondary when using CW. This method requires only 3000 volt insulation instead of 6000. This method does, however, cause one foil of the filter condenser to be raised to 6000 volts above ground on modulation peaks. However, this is of no consequence with good filter condensers. Underload and overload relays are connected in series with the secondary of the modulation transformer and in the grounded side. Should the final amplifier plate current drop below a pre-determined value the underload relay will open the 500 ohm line to the input transformer and stop modulation to prevent damage to the output transformer. At the same time, if the current of the final amplifier should exceed a pre-determined value of say 500 MA, the overload relay will disengage the primary of the final amplifier plate transformer. An additional relay is used to short-circuit the coil of the underload relay when the modulator filaments are turned off for telegraph operation. Turning off the modulator filaments also automatically shorts the Class B transformer secondary, and the switching panel is so connected that it is impossible to key the transmitter when the modulator filaments are lighted.

A condenser and resistor network is connected to the secondary of the Class B transformer to provide a source of audio voltage for a trapezoid pattern on an oscilloscope.

The bias supply is also located on the modulator chassis and is used for the final amplifier only; hence, no low resistance bleeder is necessary in order to provide good regulation. In fact, what was actually done was to provide a bleeder of sufficient resistance to act as a grid leak as well. With no grid current flowing there is sufficient bias to keep the final amplifier plate current below cut-off. When normal grid current is flowing, the voltage across the bias supply bleeder resistance rises to the normal value for Class C telephone operation. Either this method or a combination of grid leak and well regulated bias supply is recommended for best linearity in a plate modulated telephone transmitter.

The plate transformers for a 1000 watt transmitter are extremely heavy and do not lend themselves to conventional chassis mounting. In this transmitter both the 3000 volt and 1750 volt transformers were mounted in the base of the relay rack cabinet. Immediately above the plate transformers are mounted two pairs of 866 rectifiers, two input chokes, and two four MFD filter condensers. This constitutes the rectifier and filter for both high voltage power supplies. Note that only single section filters have been used. This was considered sufficient and results in a considerable saving of space. In keeping with government regulations a O-4000 volt meter is used to measure the final amplifier plate voltage at all times. The meter is mounted on the modulator panel. Provision for reducing the plate voltage to the final amplifier for adjustment is made by taking advantage of the double primary on the 3000 volt transformer. An H & H No. 8660 D.P.D.T. switch was used to connect the windings either in series or parallel.

The interconnecting cables for the units are neatly formed to fit in the rear corners of the cabinet and laced tightly with armature twine. The cables can best be made on a work bench by laying out a scale drawing of the rear view of the transmitter on wrapping paper. Nails can be driven to form a temporary channel to lay wires in and to form the bends for the various branches of the cable. All chassis are connected together by a half inch copper strip running along the side to furnish common ground. Holes of three-quarter inch diameter were drilled in reach corners of the bottom of the cabinet for the cabling that terminates on the rear of the cabinet for remote control connections. An eight contact plug is knotted on the left side in the rear of the base and handles the 500 ohm line, key, plate primary relay, voltage for trapezoid and ground. Alongside this is knotted an Amphenol 92-C receptacle for the 110 AC. Alongside the power receptacle is a four prong socket which is connected to socket U on the switch panel so as to provide a green signal light on the operating desk when filaments are on and a red light when the carrier is on.

On the right side of the rear of the base are mounted three Amphenol type PC1M connectors which are signal conductor and ground. These handle the external E.C.O. voltage, the RF from the final amplifier tank circuit for an oscilloscope and the receiving antenna connection from the change over relay. Amphenol small size flexible co-axial cable, No. 76-22S, was used for all inter-connecting links carrying RF.

### COIL CHART

L-1	B & W	BVL Swinging Link		
L-2	B & W	10, 20, 40 Or 80 BVL Coil		
L-3	B & W	10, 20, 40 Or 80 HDVL Coil		
L-4	B & W	HDVL Swinging Link		
L-5	7 mc	3.5 mc	1.7 mc	
	2T No. 22E	2T No. 22E	2T No. 22E	
L-6	7 mc	3.5 mc	1.7 mc	
	18T No. 22E	35T No. 22E	60T No. 24 E	
	Close Wound	Close Wound	Close Wound	
L-5 & L-6 Wound on Hammarlund coil form No. SWF-5				
L-7 & L-8 Bud coil unit type OSC-1				

### RECOMMENDED ASSOCIATE APPARATUS

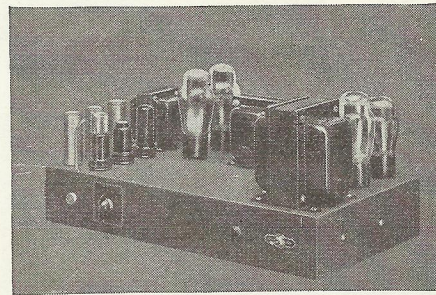

**STANCOR SPEECH AMPLIFIER**

To insure the best possible quality Phone signals, we recommend that a Speech amplifier of modern design be employed. The Stancor Model 415 using 2A3's with fixed bias delivering 15 watts of Audio works very fine with this Transmitter. Thordarson model 17K20 Speech Amplifier is also recommended and has the faculty of being used with Peak Compression if desired. UTC model SX-15M is another good speech amplifier and Kenyon also has a very fine unit. Illustrated below is a Turner Dynamic Microphone which is being used with the Transmitter with pleasing reports.

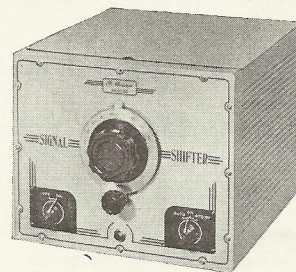

**MEISSNER SIGNAL SHIFTER**

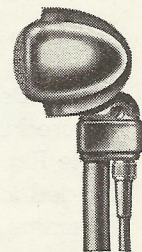

**TURNER MICROPHONE**

The modern way to operate is to be able to shift frequency to avoid QRM. The accepted unit is the Meissner Signal Shifter—a truly De Luxe instrument.



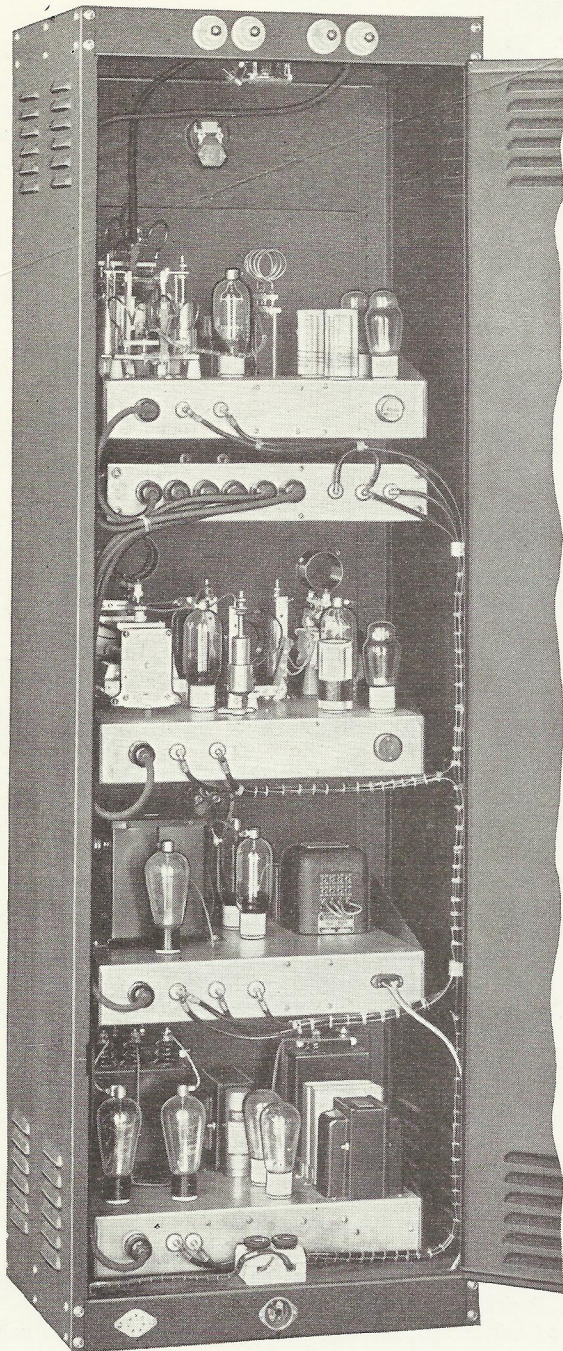

# Taylor

★★★★

**ALL-BAND  
DE LUXE  
TRANSMITTER**

---

**275 WATTS  
INPUT  
PLATE MODULATED**

---

**INSTANT  
CHANGE  
ON TWO BANDS  
AND  
RAPID CHANGE  
TO ALL OTHERS**

---

**COMPLETE SET  
OF PARTS  
ONLY**

**\$290.00**

**OBTAINABLE  
AT ALL  
TAYLOR TUBE  
DISTRIBUTORS**

---

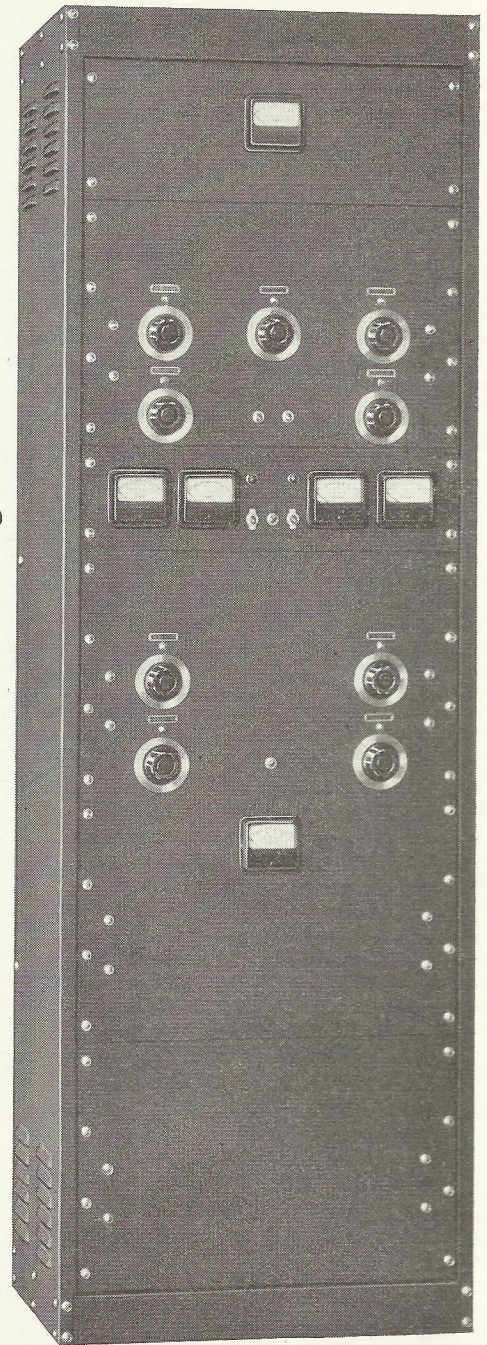

## *Drilled Chassis Furnished Free!*

**THIS OFFER EFFECTIVE IN U. S. ONLY AND EXPIRES DECEMBER 31, 1940**

This DeLuxe Rig is so extremely popular that we are republishing it. It incorporates ideas gathered from discussions with hundreds of Amateurs from all over the country. Since completion of the Rig many Amateurs have seen it and the comments were so unanimously enthusiastic that we decided to make this Transmitter available for easy construction at a new low price standard. All apparatus used and recommended are in line with Taylor's "More Watts per Dollar" value and the appearance and performance on all Bands meets Broadcast Station standards. **A complete set of four high quality steel chassis, with all socket and other large holes already drilled, will be furnished free of charge through your Distributor when you purchase the complete set of tubes for this Transmitter.** This bulletin gives full technical information.



## FEATURES OF THE TAYLOR DE LUXE DUAL TRANSMITTER

### TWO COMPLETE RF UNITS

offering High Efficiency performance on

#### ALL BANDS—5 METERS TO 160 METERS

one RF Unit for 20, 40, 80 and 160 and the other for 5, 10 and 20 meters.

Using a separate and complete RF unit for low frequencies and another for high frequencies makes possible, as in no other manner, correct L/C ratios with due regard to the linearity which is necessary for good fone operation.

### INSTANT BAND CHANGING

from one RF unit to the other by the flip of one Toggle switch. You set the two RF units on any such bands you desire to operate on such as 160 meters in low frequency unit and 10 meters in the high frequency unit and you can change coils for operation on any other bands within two minutes time. TZ-40 tubes were chosen because their Zero bias features eliminated any necessity for bias supplies and also avoided the loss of input power that occurs when a cathode bias resistor is used. The TZ-40's also are slightly easier to drive and this helps considerably in the case of the TZ-40 doubler because a high gain tube doubles most efficiently.

### FULL INPUT ON ALL BANDS

Although the normal rating of the Taylor TZ-40 is 115 watts input at 1000 volts, we have found, and thoroughly guarantee, that TZ-40's will give increased power at 1250 volts without any loss of life. In this transmitter, 1250 volts is used on the P.P. Final amplifier TZ-40's as well as on the Class B modulator TZ-40's. Operation of the final amplifier at 110 MA per tube or a total of 220 MA for the two tubes gives an input of 275 watts which can be used on all Bands including 5 meters without overloading the tubes. In every stage, the tubes are operated conservatively and if you have built the rig correctly using good parts, no color will show in the anodes because the plate dissipation rating will not be exceeded. The 1250 volts is reduced to approx. 850 volts on the TZ-40 Buffer Doubler stage through the use of a 5000 ohm 100-watt Ohmite resistor.

### ALL DRILLED CHASSIS FREE

Your Distributor will give you free of charge a set of chassis' when you purchase a complete set of Taylor Tubes for this Transmitter.

The Chassis have all socket and grommet holes punched. All small holes are left undrilled to allow the use of such equipment

which you may have on hand or a choice of using equipment other than shown. The accompanying photos show placement of parts very clearly and for this reason templates are not necessary and are not furnished.

### NEW LOW COST

The new price standard that this Deluxe transmitter arrives at, is possible due to the availability of the Taylor TZ-40's which established a new conception of "More Watts per Dollar." Secondly, the idea of having two complete RF units with one set of power supplies, meters and modulator equipment means that you actually have two entirely complete rigs at approximately one-half the former cost.

### MODULATOR WITH PEAK COMPRESSION

TZ-40 tubes are used in the Class B modulator unit as their advantages and value are obvious. Peak compression was incorporated as in the opinion of the Taylor engineers this feature is most desirable for amateur phone operation. The Waller (W2BRO) system met our approval and as the Thordarson Engineers had just announced a new special Amateur speech amplifier kit, their No. T17K20 including this type of peak compression control, we decided to specify the Thordarson unit as offering exactly what we would have built, and at an extremely reasonable price. Undoubtedly other transformer Manufacturers will shortly announce speech amplifier kits with the peak compression feature and such units will serve as well as this Thordarson kit. Experiments proved that a standard 866 performs perfectly as the control voltage diode rectifier in place of the 879 specified in some articles. Complete information on the speech amplifier is furnished by Thordarson so we will not repeat that information in this bulletin. We show an illustration of the T-17K20 kit to give you an idea of its appearance. See page 32.

### REMOTE CONTROL

For ease of operation, a relay is supplied on the meter and switching chassis so that plate voltages can be controlled at a remote operating position. The leads for this as well as for keying, 500 ohm line and peak compression control voltage are brought out near the bottom of the rack through a convenient socket and plug arrangement. A.C. input to the rig is brought in through a recessed receptacle with the plug fitting on the cord so that no electric cord will be in the way when the rig is moved.

## COMPLETE CONSTRUCTIONAL DATA

We will describe in detail the construction and purposes of each individual unit and give exact information as to what "kinks" we ran into so that you will be able to "go on the air" with the least possible trouble and effort. So simple and conventional is this hookup that only two small difficulties were encountered. Parasitics in final and hitting resonance on 5 meters. This is explained further in this article.

### UNIT NO. 1—ANTENNA TERMINAL AND METER PANEL

This is the top unit in the rack and no chassis is used. An 0 to 5 Triplett Illuminated RF Ammeter and a Ward Leonard Special Mycalex insulated 250 watt capacity antenna relay are used to accomplish switching of the RF Ammeter to the antenna desired, automatically. Two sets of Johnson Feed-thru insulators are mounted on the rear of the rack to which can be left permanently installed any two desired antennas. A Class A license Amateur might have a 20 meter antenna and a 75 meter antenna connected for instant use and the Class B Amateur might have 160 meter and 10 meter antenna connected. In other words, any two antennas can be connected—ready for instant change by the flip of the same toggle switch that actuates the choice of RF units. The RF ammeter, relay Feed-thru insulators are connected to the swinging links of the output stages of the two RF units by the required lengths of the new Amphenol Flexible Coaxial Cable. This system provides for any antenna that can be fed by low impedance transmission lines. There is sufficient space left on the panel and to the back of it for mounting variable condensers and coils if an Antenna tuning unit is desired for tuning transmission lines. A Bud 7" Black Crystalline finish Masonite panel is used as it was found

that when operating on 5 meters there was danger of damaging the RF ammeter if a metal panel was used.

### SPECIAL DATA—UNIT NO. 1

The Relay is suspended from the top of the cabinet by means of two Johnson 1½" Alsimag Cones and the Thermo couple also suspended by means of two Johnson 1" Cones.

### UNIT NO. 2—HIGH FREQUENCY RF CHASSIS

This is the 12¼" panel and 17" x 13" x 3" chassis next below the antenna panel and it houses the complete RF stages from Crystal to Final Amplifier for the 5, 10 and 20 meter unit. The panel is Bud No. 1256A 12¼" and the chassis is 13" x 17" x 3". Several months were devoted to extensively studying all Crystal circuits and for this unit where both fundamental or harmonic operation of the crystal may be used, it was decided that the Jones regenerative oscillator was the proper circuit. Referring to Condenser C-1 (.0001) which controls the amount of regeneration, it was found that this value was optimum for normal crystals. For slightly inactive crystals it may be necessary to use .00005 mmf. in order to secure correct oscillation. No other special information is necessary as this crystal circuit performs in a satisfactory manner with low crystal current. The crystal oscillator tube used is the New Taylor T21 Beam Tube which is ideal for this work.

When using the transmitter on 5 meters best results will be obtained with a 20 meter crystal and 20 meter coil in the oscillator plate circuit. However, sufficient excitation can be had from a 40 meter crystal. When using a 40 meter crystal for 5 meter output a 20 meter oscillator plate coil is used and the oscillator becomes a harmonic oscillator. For 10 meter output either 40 or 20 meter



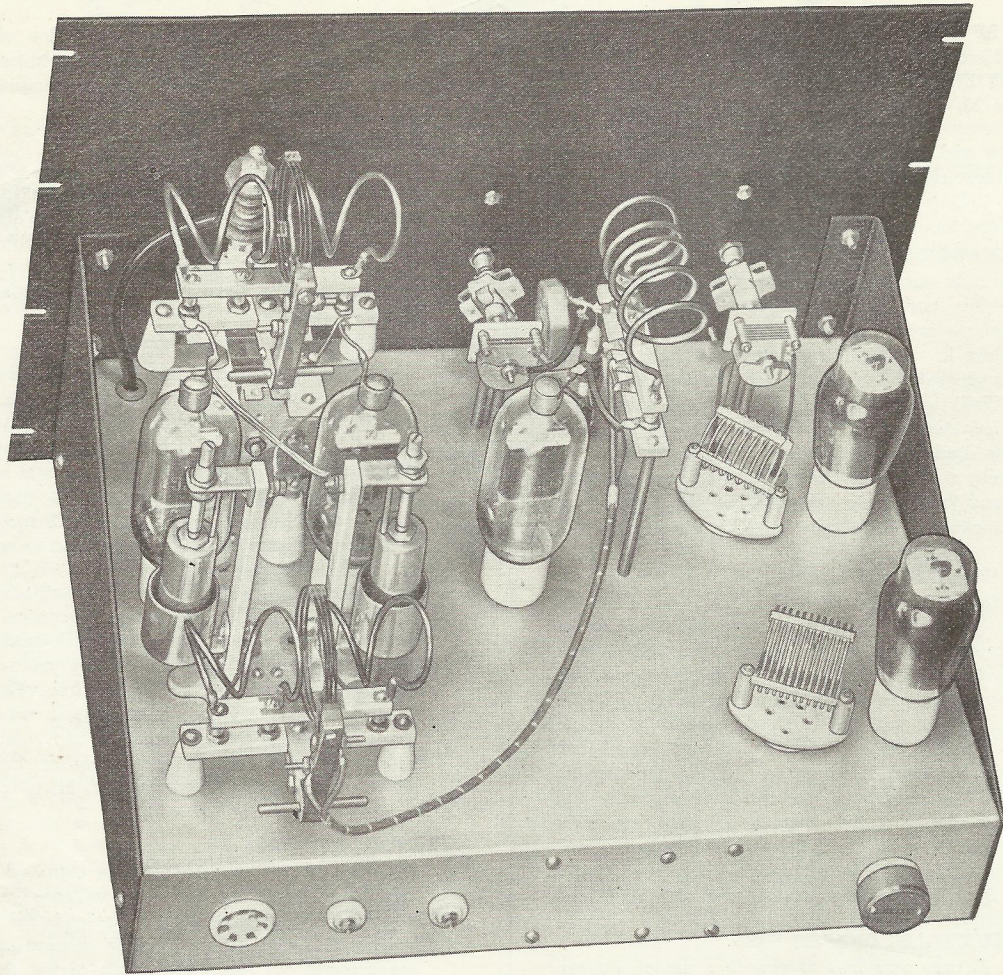

Top View—Unit No. 2—High Freq. R.F.

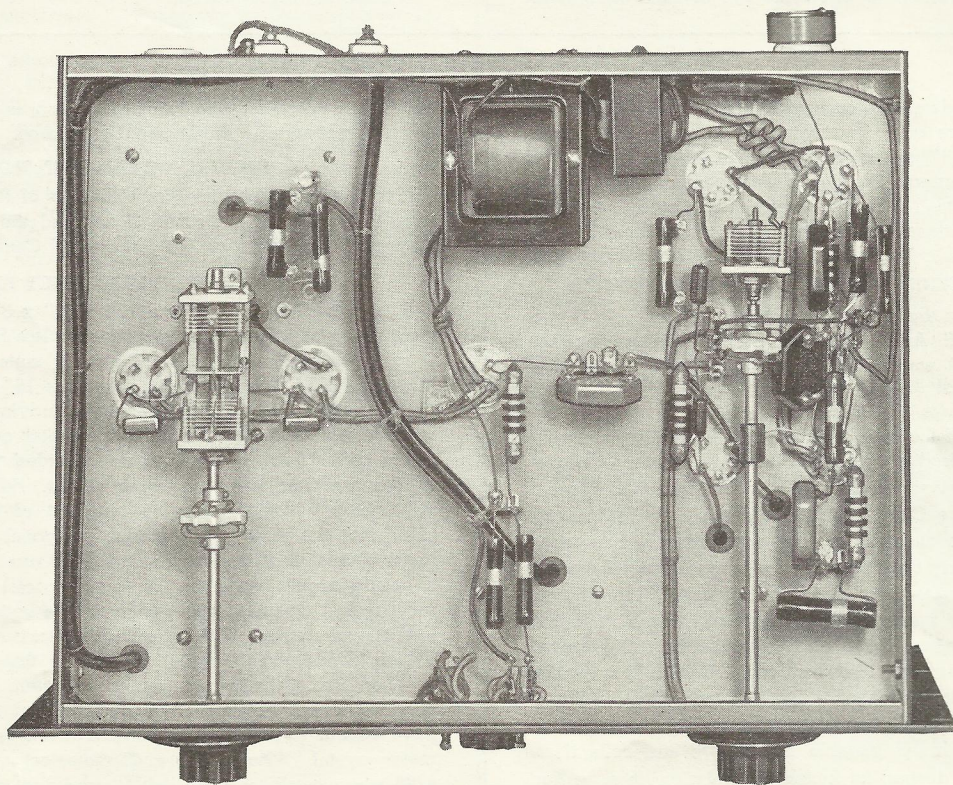

Bottom View—Unit No. 2—High Freq. R.F.



crystals are recommended, although an 80 meter crystal could be used. For 20 meter output a 40 meter crystal is recommended. However, an 80 meter crystal could be used. It is interesting to note that 5, 10 and 20 meter output can be had all from a 40 meter crystal. The oscillator is followed by a T21 Buffer-Doubler stage which can be operated on the same or twice the frequency of the oscillator, **but must be operated always at one-half the output frequency of the final stage.** Note that the cathode of both oscillator and the second T21 are both opened by keying. This is necessary to eliminate neutralization of the second T21 and no neutralization is necessary for stable operation as long as excitation is applied. The output of this stage is capacity coupled to a TZ40 **which must always operate as a doubler.** This eliminates the necessity of neutralizing this stage and lends toward perfect stability which is often difficult to obtain from a single ended neutralized stage at ultra high frequencies. The TZ40 is highly desirable in this stage due to its high amplification factor, 40 to 50% plate efficiency being easily obtained. This plate efficiency in doubling is certainly worthy of consideration to anyone that desires large amounts of driving power at high frequencies from a small grid input—and freedom from neutralization. Note that a very high value of grid leak, 25,000 ohms is used and under these conditions the normal rectified grid current should be 5 to 6 MA. This is equivalent to 10 to 12 times cut off bias. Up to this stage capacity coupling between stages has been used to eliminate all possible tuned circuits. The TZ40 doubler is link coupled to a B & W BVL unit in the grid circuit of the push pull TZ40 final amplifier. This provides a means of perfect regulation of the excitation to the final amplifier.

#### SPECIAL DATA—UNIT NO. 2

On preliminary test the final was found to contain a severe case of ultra high parasitic oscillation even though it was perfectly neutralized for the operating frequency. The trouble was due to the plate and grid leads, which are both very short and approximately the same length, falling in resonance and creating a push pull UHF oscillator. Under these conditions, the normal tank coils act as RF chokes to supply plate voltage and grid return to the TZ40's. This condition was cured by using nichrome wire of No. 22 gauge from the grid terminals on the sockets to the tuning condensers. These connections are referred to as Rx in the wiring diagram. The resistance has a negligible effect on the driving power required for the final and lends to perfect stability. Nichrome wire of approximately No. 22 gauge can be secured at Electrical Supply houses or can be removed from old rheostats or tapped filament resistors. Further evidence of the stability of the amplifier can be had from the fact that no fixed bias is used and no self oscillation is experienced when the excitation is removed and with the TZ40's drawing their normal resting current of 70 MA at 1250 V. One setting of neutralization will hold for both 10 and 20 meter operation and it is only necessary to increase the capacity of the Johnson N125 neutralizing condensers by approximately 2 turns of the lead screw for 5 meters. Preliminary neutralizing should be done by removing the 1250 V lead from the final amplifier and with the remainder of the transmitter operating adjust the N125 condensers until no dips occur in the grid current of the final which should read approximately 80 MA with no plate voltage. As a final check for perfect neutralization apply plate voltage to the final and place transmitter in operation. The final amplifier grid current will drop from 80 MA to approximately 60 MA with plate tank tuned to resonance and with antenna or dummy load connected. Note that the filament center tap of the TZ40 transformer is left ungrounded, with one side of each filament grounded and the opposite leg of each filament by-passed to ground. This was done to remove as much inductance as possible from the filament circuit to accomplish greater stability. The carrier is free of A. C. hum and no ill effects to the tubes can result from this connection. Two D. P. D. T. switches are provided to switch meter. One is connected in the grid circuit of the TZ40 doubler and push pull TZ40 final in order to measure either circuit with one meter. The other is used to select either oscillator current or first buffer doubler plate current. Note that two 400 volt lines have been provided, one being through the meter and the other unmetered. This is necessary in order to read true plate current on the T21's instead of plate current plus bleeder and screen current.

The output from the final is taken from the swinging link of the B. & W. BVL unit providing perfect control of the amount of antenna coupling.

The Oscillator tuning condenser C-4 is mounted underneath the chassis approximately 8" from the panel. A 6" Johnson panel bearing, a brass 1/4" to 1/4" coupler and a Johnson flexible coupler type 250 are used to couple up with the dial. C-4 is mounted on a Trim-Air mounting bracket attached to two Cardwell BHP Hex. posts which are bolted to the chassis. First Buffer Doubler Condenser C-8 is mounted above the chassis—using a Trim-Air bracket attached to two Cardwell BMP mounting posts (reduced 1/8" in length). Condenser C-11 is mounted in exactly the same manner. The 2nd Doubler tank coil plugs into a B & W Jack strip type A-56 mounted on two FMP mounting pillars. The final amplifier grid tuning condenser C-12 beneath chassis is attached to the chassis thru use of two Trim-Air brackets. A 6" panel bearing and Johnson flexible coupler No. 250 connect the condenser to the Dial. The final amplifier tank condenser C-15 is mounted with terminals in up position, on 4-Johnson 1 1/2" Cone insulators on which have been mounted 4-Cardwell Standard mounting brackets. By following these instructions and dimensions all dials will appear in position shown in illustration. On top of C-15, the final amplifier tank coil—B & W BVL—is mounted thru use of two Johnson 1" Cones attached to two small brackets. 1 3/4" x 3/4" cut from 1/8" sheet aluminum. Feed-thru insulators used on rear of chassis are Johnson type 55. Dials used are Bud No. 713-2 3/4".

#### UNIT NO. 3—METER AND SWITCHING PANEL

This panel is located between the two RF chassis' and is provided with 4 milliammeters of proper size for measuring plate and grid currents of either chassis'. This 5 1/4" panel is also provided with one D.P.S.T. toggle switch, connected for parallel operation to increase current carrying capacity, for lighting filaments and meter light. A S.P.S.T. toggle switch is used to operate the plate on and off relay which is a Guardian No. R100 110 A.C. operated. A third toggle switch, D.P.D.T. is used for band switching. A thorough understanding of the switching system used here is necessary for anyone constructing a rig like this as we believe this is the first Amateur transmitter kit to use such a system. Note that both RF sections are alike as far as operating voltages are concerned so that one set of power supply, modulator and meter are used. Plate voltage is connected to both chassis through the meters so both chassis would normally operate if it were not for provision being made to not have more than one chassis supplied with filament voltage at one time. One side of the D.P.D.T. switch is used to complete the primary circuit of the TZ40 filament transformers so that in one position the high frequency RF section filaments are lighted and in the other position the low frequency RF section filaments are lighted. Since instantaneous band switching was desired it was not possible to handle the T21 tubes in the same manner as they have indirectly heated cathodes. The T21's in both units are lighted at all times and the cathode circuit is selected by the other side of the D.P.D.T. switch. The center of the cathode side of the band change switch becomes one side of the key connection and the other side of the key is grounded.

The rear panel is Bud No. 139 mounted on four Bud No. 138 spacer rods. The relay is mounted on the rear panel with a Cardwell AMP mounting pillar and the filament transformer with two AMP's.

The Ohmite 75 watt 5,000 ohm resistor R-19 is mounted to the rear by means of their regular bracket and at the front end by means of their bracket and a piece of 1/8" sheet aluminum 2 3/8" by 3/8" which is fastened across the two spacer rods. Johnson type 55 feed-thru insulators are used and the sockets are Amphenol Steatite as they are thruout the entire Rig. Wiring is laced to the spacer rods adding much to the appearance. All high Voltage leads are type 7MM high tension cable. Lenz Dulac Wire was used in all the other cabling. This wire is available in many colors so that a color coding system can be followed.

#### UNIT NO. 4—LOW FREQUENCY R. F. CHASSIS

The R. F. section designed to operate on 20, 40, 80 and 160 meters is mounted on the same size chassis and panel as the R. F. sections and the same front layout was maintained for good

(Continued on Page 45)



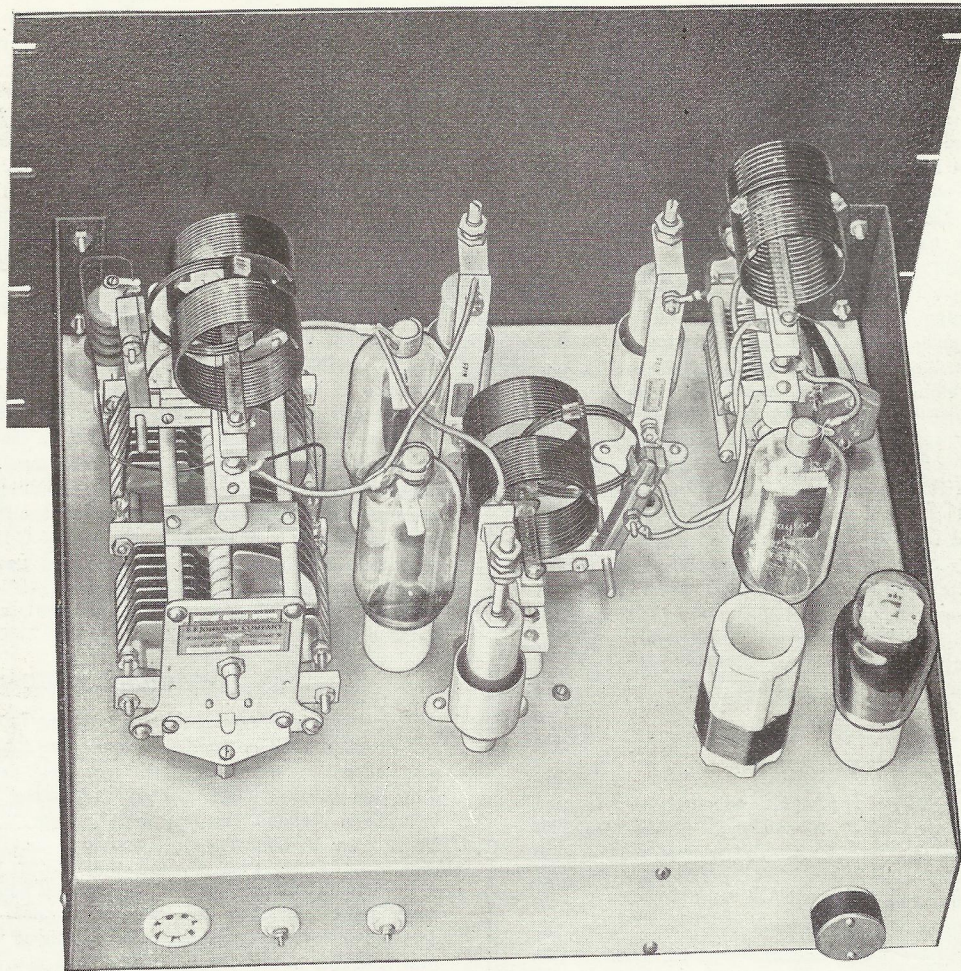

Top View—Unit No. 4—Low Freq. R.F.

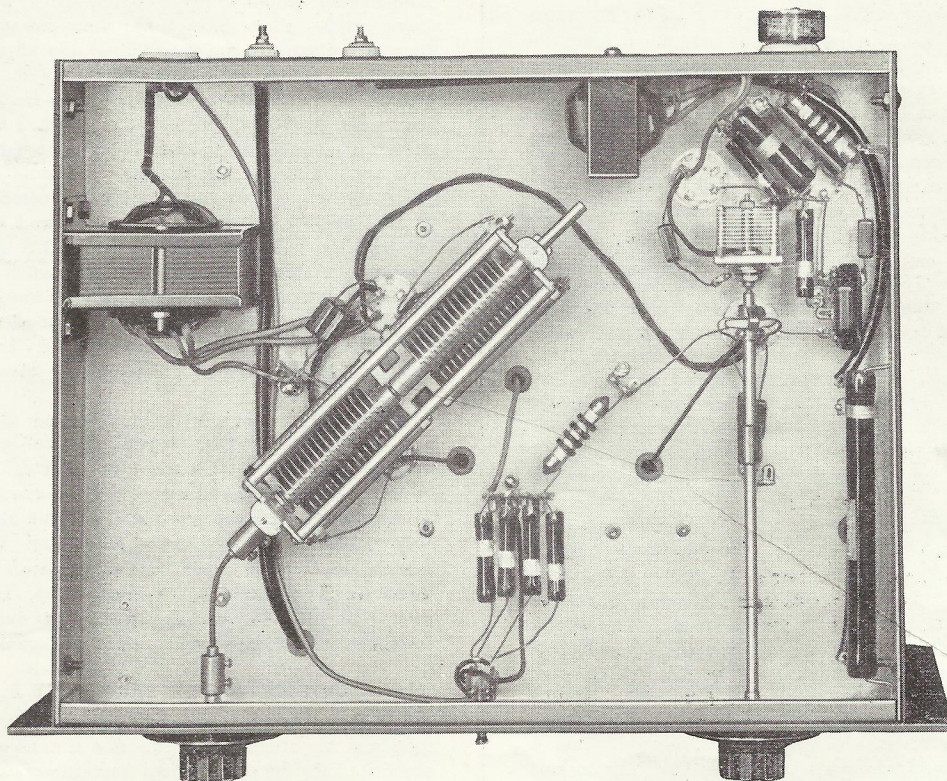

Bottom View—Unit No. 4—Low Freq. R.F.





Unit No. 5—Modulator

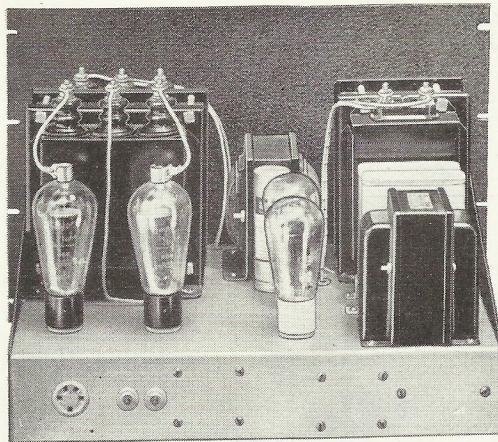

Unit No. 6—Power Supply

**PARTS LIST**

- T1 —6.3V 3A T-19F97\*; S-P5014; G-1052; U-2296.  
 T2 —7.5V 8A T-19F94\*; S-P6138.  
 T3-T4—same as T1. T5-T6—same as T2.  
 T7 —2.5V 10A T-19F90\*; S-P3025; U-1819.  
 T8 —Input Transformer T-15D82\*; S-A4704; U-8132.  
 T9 —Modulation Transformer T-14M49\*; S-A3829; U-8669.  
 T10—Plate Transformer 1250V 500 MA. T-19P63\*; S-P6153; U-1809.  
 T11—Same as T7.  
 T12—2.5V 5.25A T-19F88\*; S-P6140; G-1416; U-2425.  
 T13—Plate Transformer 400 V 250 MA T-19P55\*; S-P3010; U-1800.  
 Ch 1—8H. 200 MA choke T-13C30\*; S-C1411; G-2158; U-4510.  
 Ch 2-5—20H 500 MA choke T-19C38\*; S-C1405; G-2160; U-4505.  
 CH 3—12H 300 MA choke T-19C43\*; S-C1413; G-2156; U-1800.  
 M1—5 amp. RF ammeter Triplett Type 346.  
 M2—150 MA Triplett Type 326 or 227.  
 M3—100 MA Triplett Type 326 or 227.  
 M4—200 MA Triplett Type 326 or 227.  
 M5—500 MA Triplett Type 326 or 227.  
 M6—500 MA Triplett Type 326 or 227.  
 SW1, SW2, SW4, SW6—DPDT Toggle Switch—Bud.  
 SW3—DPST Toggle Switch—Bud.  
 SW5—SPST Toggle Switch—Bud.  
 SW7—Guardian SPST R-100 Relay.  
 C4 —.000075—\*C-ZU75AS; N-ST75; H-MC-75M.  
 C8 —.000075—Same as C4.  
 C11—.000025—\*C-ZR25AS; J-25G20; N-SEU25; H-MC-20MX.  
 C12—.00005 —\*C-ER50AD; N-STD50; H-MC-50MX.  
 C15—.000035—\*C-NP35ND.  
 C19—.0001 —CZU100AS; \*J-100F20; N-ST100; H-MC-100M.  
 C23—.00015—C-MT150GS; \*J-150F20; N-TMC150; H-TC165K.  
 C24—.0002 —\*J-200FD20; H-TCD210L.  
 C29—.0002 —C-XE240KD; \*J-200DD35.  
 NC—Johnson NC-125.  
 T = Thordarson S = Stancor G = General U = Utah  
 C = Cardwell; J = Johnson; N = National; H = Hammarlund.  
 \* Indicates parts used and shown in photos.

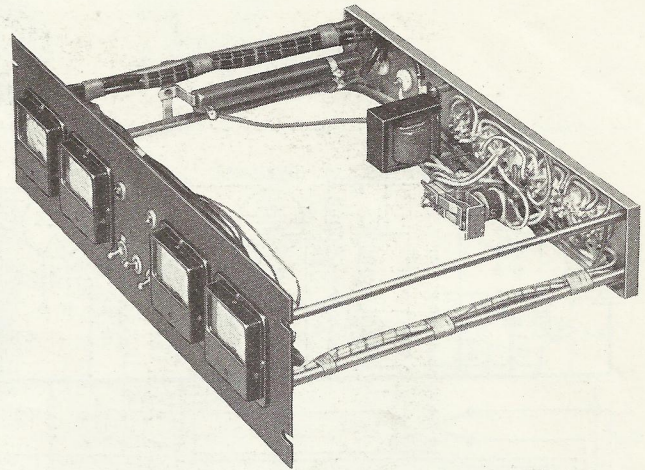

Unit No. 4—Meter Panel

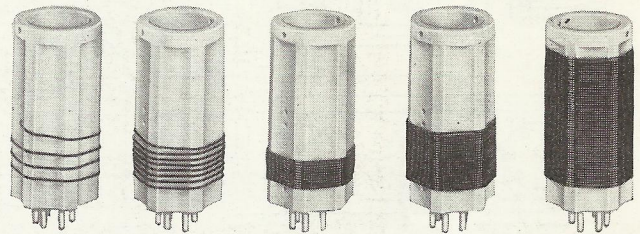

Coils

Band	L <sub>1</sub>	L <sub>2</sub>	L <sub>9</sub>
160 Meters	56 turns No. 16 1 3/4" dia. close wound	Same as L <sub>1</sub>	Same as L <sub>1</sub>
80 Meters	25 turns No. 16 1 3/4" dia. close wound	Same as L <sub>1</sub>	Same as L <sub>1</sub>
40 Meters	12 turns No. 16 1 3/4" dia. close wound	Same as L <sub>1</sub>	Same as L <sub>1</sub>
20 Meters	7 turns No. 16 1" long 1 3/4" dia.	Same as L <sub>1</sub>	Same as L <sub>1</sub>
10 Meters	3 1/2 turns No. 16 1" long 1 3/4" dia.	Same as L <sub>1</sub>	Same as L <sub>1</sub>

L<sub>3</sub> and L<sub>4</sub> = B & W type BL coil with end link.  
 L<sub>5</sub>, L<sub>8</sub>, L<sub>12</sub> and L<sub>15</sub> = B & W type BVL swinging link assembly.  
 L<sub>6</sub>, L<sub>7</sub>, L<sub>13</sub> and L<sub>14</sub> = B & W BVL coils. (See text.)  
 L<sub>10</sub> and L<sub>11</sub> = B & W type BL coil with center link.

See Text on Coils, Page 28.

- R1, 13—50,000 ohm 1 watt IRC  
 R2, 3, 6, 15, 16, 17—10,000 ohm 10 watt Ohmite\* or IRC  
 R4 — 5,000 ohm 10 watt Ohmite or IRC  
 R5 — 50,000 ohm 10 watt Ohmite or IRC  
 R7 — 25,000 ohm 10 watt Ohmite or IRC  
 R8, 9, 12, 18, 20, 21—1,000 ohm 10 watt Ohmite or IRC  
 R10— 750 ohm 10 watt Ohmite or IRC  
 R11— 5,000 ohm 100 watt Ohmite or IRC  
 R14— 200 ohm 10 watt Ohmite or IRC  
 R19— 5,000 ohm 75 watt Ohmite or IRC  
 R22— 100 ohm 10 watt Ohmite or IRC  
 R23—100,000 ohm 100 watt Ohmite or IRC  
 Rx —See "Special data" Unit No. 2  
 C1, 30—.001 mica 2500V Cornell-Dubilier  
 C2, 3, 6, 7, 9, 13, 14, 16, 17, 18, 21, 22, 25, 26, 27, 28—.006 mica 600V C-D  
 C5, 20—.00005 mica 2500V C-D  
 C10-C34—.002 mica 2500V C-D  
 C31—8 mfd 450V electrolytic C-D  
 C32, C33—4 mfd 1500V C-D  
 RFC —R100's National  
 RFC-1—R154's National



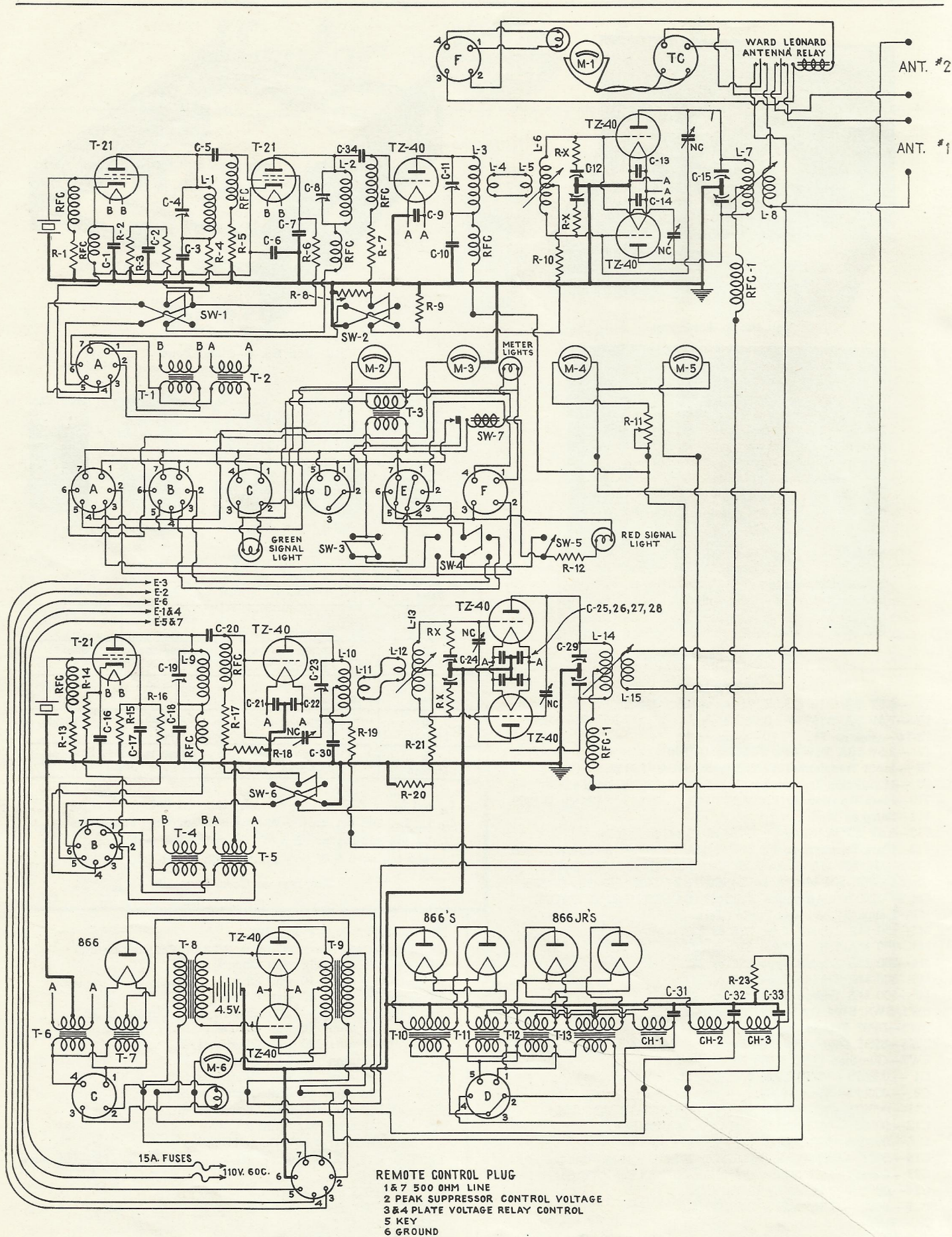

Fig. 1

Errata: Add a by-pass condenser, same as C-3, from bottom of L-2 to ground. Add wire from top of SW-3 to terminal 3 of socket E.



#### UNIT 4—CONT.

appearance. The layout is essentially the same as the high frequency chassis except that only one T21 is used and that tank condensers of proper size for the lower frequencies were used. The T21 oscillator as shown is a straight pentode oscillator and can be converted to a regenerative type if desired by adding a R100 choke and .0001 condenser. In most cases, we believe this is not necessary as the TZ40 following can be used as a doubler or fundamental amplifier and furnish ample excitation for the PP TZ40 final. It was found advisable to add an additional 5000 ohm series resistor to the first TZ40 of this unit in order to reduce the available excitation to a more reasonable limit, as the efficiency of this stage is considerably higher than the corresponding stage in the other chassis due to lower operating frequencies. A single section condenser with RF ground on center of the plate coil of this stage was used to effect plate neutralization. This permits using an RF choke in the grid circuit with capacity coupling and the elimination of a choke in the plate circuit alleviating any chance of low frequency parasitics. The final amplifier is a conventional PP amplifier except the same precautions were taken to eliminate ultra high frequency parasitics as were used in the other chassis. B & W BVL units were used in both grid and plate circuits in order to have complete control over excitation and antenna coupling. It will be noticed that it is possible to operate either RF section on the 20 meter band. This is easily accomplished with proper L/C ratios by the proper selection of parts. This feature should be very popular with those Amateurs who prefer to operate exclusively in the high and ultra high frequencies as this unit which we refer to as the low frequency unit can be left on 20 meters and the high frequency unit then can be ready for instant use on either 5 or 10 meters.

Condenser C-19 is the same as C-4 in Unit No. 2. Condenser C-23 is mounted on two Johnson 1½" Cones. Buffer-Doubler tank coil is mounted on top of C-23 by means of ½" Cones which are fastened to the condenser with the angles that come with Johnson condensers. Final amplifier grid tuning condenser C-24 is mounted in at an angle in order to give short grid leads. It is attached to the chassis thru use of the regular Johnson condenser brackets and stood off on the spacers that ordinarily are used to hold the condenser on a panel. Tuning is accomplished thru use of a panel bearing—3" flexible shaft and two ¼" to ¼" shaft couplings. Coil L-13, a B & W BVL unit has the jack bar mounted on two ½" Cones. Condenser C-29 is mounted on two Johnson panel spacers that come with the unit. The shaft is connected to the dial thru use of a Johnson ¼" to ¼" No. 252 coupler and 1½" of ¼" shaft. Coil L-14 is mounted on top of C-29 by means of two 2½" x ¾" x ⅜" aluminum bars. Holes are drilled thru these bars and thru the condenser tie rods. Tie rod holes are tapped 6/32. All wires that go thru the top of the chassis are carried thru ⅜" rubber grommets—these holes are already drilled in the chassis.

#### UNIT NO. 5 CLASS B MODULATOR

This unit uses two type TZ40 tubes in conjunction with a Thordarson T-15D82 Multi match 500 ohm line to grid transformer and a Thordarson T-14M49 modulation transformer. Since the TZ40's are operating at 1250 volts off the common plate supply there is available approximately 225 watts of audio which would over modulate the normal 275 watt unput if the grids are driven too extreme. It was found necessary to operate the input transformer at a ratio of 1 to .75 to properly regulate the drive. A 4-5 VC battery is necessary to limit the resting current when using 1250V on the plates, the normal current under this condition being approximately 30Ma. This chassis also contains a single 866 rectifier and filament transformer. This tube is used as a rectifier to operate the peak limiting circuit in the Thordarson amplifier. Full details as to the theory of operation can be found in the October, 1937, issue of QST Page 31. The 500 ohm line input and the peak limiting bias line are brought into the chassis by means of an Amphenol type S3S socket and 70-3S plug. The secondary of the Class B should be operated on the 4500 ohm connection. The 500 ohm line should connect to the A terminals of the multi match input transformer. The G terminals on the jack panel of the transformer should be connected to the .75 connection. Complete modulation with sine wave input is accomplished with an average plate current of approximately 180 MA and with voice input approximately 110 MA.

The peak limiting circuit used with this transmitter automatically limits the plate current to the above values even if the gain control is turned full on. These parts are mounted on a 17X13X3 chassis and a 12¼" steel front panel.

#### UNIT NO. 6 POWER SUPPLY

The entire transmitter is operated from one 1000 to 1250 Volt 500 MA power supply and one 400 Volt 150 MA power supply. Both units are mounted on one 3x17x13 chassis. The voltage for the Class B modulator is taken off after the T-19C38 500 MA swinging choke and the Class C voltage is further filtered by a smoothing choke (T-19C43) and condenser. This constitutes a saving in space and money in that only a 300 MA smoothing choke is required and the Class C voltage regulation is improved. No hum can be detected on any frequency even with the Class C input 50% above normal. A 100,000 ohm 100 watt Ohmite bleeder resistor is used on the high voltage power supply.

#### PERFORMANCE

This transmitter has been designed for a normal input of 275 watts equivalent to 220 MA final amplifier plate current when using 1250 volts on the plate. In actual operation this was easily accomplished on all bands including 5 meters. Measured power output gave an indicated plate efficiency of 65% on 5 meters and 70% or better on all other bands. At these percentages of efficiencies no color will show on the anodes. Taylor carbon anodes in the T-40 and TZ-40 type tubes show color at 60 watts plate dissipation and if color is noted it is obvious that efficiency is low. By comparing meter reading and adjusting your circuit to conform to the meter readings listed below it is next to an impossibility to obtain anything but a high percentage of efficiency. A typical set of meter readings are listed below which hold for all frequencies.

#### HIGH FREQUENCY UNIT

Osc. Pl.	1st doubler pl.	2nd doubler grid.	2nd doubler pl.
30 MA	40-60 MA	5-6 MA	60-80
Final Amp.	grid	Final Amp.	Pl.
50 MA			220

#### LOW FREQUENCY UNIT

Osc. Pl.	Double Buffer Pl.	Final Amp. grid	Final Amp. Pl.
30 MA	50 MA	50 MA	220 MA

If the low frequency is built with the intention of 160 meter telephone operation, it will be necessary to reduce the plate voltage to 1000 volts, which is easily accomplished by changing the primary connection to the plate transformer. This is due to the fact that the 200 DD 35 does not have quite sufficient spacing for 1250 volt lone operation. Condensers of sufficient spacing and capacity for 160 meter telephone operation with 1250 volts are generally too large to mount on a 13 inch chassis. By eliminating 160 meters from the low frequency unit, a Johnson type 100 DD 70 can be substituted C-29. This condenser will permit 1250 volt operation as low as approximately 3600KC. The two condensers are approximately the same size and price. There is still one possibility that should work but has not been tried, which is to insulate the condenser from ground and by pass it to ground with a .001 2500 volt condenser. This will allow a connection to be made from the positive high voltage supply to the RF choke and the frame of the condenser. This will increase the flash over voltage of the condenser considerably. Further details on this arrangement can be found in December 1938 QST, page 37. If this method is used, great care should be used in the selection of the tuning dial as it must be able to insulate the operator from 2500 volts.

#### COILS

All plate coils for the T-21 stages of both RF sections plug into 5-prong Amphenol Steatite sockets. All these coils are identical for a given frequency. Coils may be wound on Johnson 647 5-prong coil forms from data given in Fig. No. 2 or if it is desired to use manufactured coils, Decker low power coils without link or center taps can be used. These coils are designed for link coupling and as these units use capacity coupling it is necessary to tap the Decker coil, removing sufficient inductance to compensate for the added capacity.

All coils used in the TZ-40 grid and plate circuits are Barker & Williamson. This we believe is far better than making improvised coils, and proper L/C ratio is insured. Each final amplifier uses two 2 BVL units, one in the grid circuit and the other in the plate, in order to have perfect regulation of grid drive and antenna coupling.

For 160 meter operation of the low frequency unit, special Barker-Williamson type BVL coils are necessary. These coils are known as Taylor Tyle 160BVL, and may be had at your jobber.

The TZ-40 doubler stage in the High Frequency unit uses B & W type BL coils with end link which mounts in a B & W type A56 Jack bar. The TZ-40 doubler or buffer stage in the low frequency unit uses B & W type BL center linked coils which mount in a type A56 Jack bar.

When setting up the high frequency unit on 5 meters it is necessary to spread the turn on the 5 BL and 5 BVL coils until the coils occupy slightly more than the length of the insulating bar as can be seen in the photograph of the high frequency unit. It is also necessary to connect the two inner banana type plugs on the 5 BVL coils together with a strip of sheet copper in order to remove the inductance normally contributed by the banana jacks and jumper across the jacks. When this is done, resonance in the middle of the 5 meter band will occur at approximately 10 degrees on both grid and plate tuning condenser of the final amplifier and at approximately 25 degrees on the TZ-40 double plate tuning condenser.



## IMPORTANT INFORMATION

**TESTING TUBES:** As many of the tubes returned to us as defective test out OK here we want to make some suggestions that will enable every amateur to give doubtful tubes a partial emission test in his own transmitter. Most amateurs have or can easily obtain a 6.3 volt or 10 volt transformer. In the case of testing a tube which has a 7.5 volt filament, replace the 7.5 volt transformer with a 6.3 volt transformer. Then, without making any other changes, note the readings of the meters in the grid and plate circuits of the tube being tested. There should be only a slight drop in the plate current while the grid current may drop to ½ its former value and the tube would still be satisfactory condition. Should the grid current drop in excess of ½ the original value the filament emission can be considered as below normal and the tube should be returned to us for inspection.

In the case of 10 volt tubes when the filament voltage is dropped to 7.5 volts by substituting transformer, the grid current can be expected to drop to approximately ½ the normal value. Should the grid current drop in excess of ¼ the original reading the tube can be considered as having low filament emission.

The above information is based on tubes being operated as class C amplifiers with the normal rated plate current flowing. Should a tube become defective for reasons other than filament emission such as glass failure or element lead wires damage the cause should be determined before replacing with a new tube. Glass failure in the case of tube with both grid and filament leads brought out through one press is usually caused by; excessive grid voltage, excessive R.F. grid current or approaching the upper frequency limit of practical operation without reducing the power input. In the case of plate leads the glass may be cracked from excessive R.F. current. The R.F. current in the plate lead increases directly with frequency and is particularly destructive in cases where V.H.F. parasitic oscillation are present. We suggest that attention be paid to the notes on the cause and cure of such oscillations in the Technical data on page 41 under heading of "Special data Unit No. 2".

Experience has proven to us that transmitting tubes can not be shipped via Parcel Post with safety. When tubes are returned for inspection pack the tubes very carefully and ship via Express.

### CALCULATING BIAS

To calculate necessary bias for a Class "C" stage (any type tube) divide the plate voltage by the amplification factor and multiply by two for approximate double cutoff. For higher efficiency add at least 40% more to this figure. For C. W. Class "C" or buffer stages, multiply by 1.5.

For example take a 203A tube which is to be used as an amplifier with 1000 volts on the plate. This tube has an amplification factor of 25

$$\frac{1000}{25} = 40 \times 2 = 80 + 32 (40\%) = 112 \text{ volts}$$

necessary for double cutoff plus 40% for phone operation.  
For CW

$$\frac{1000}{25} = 40 \times 1.5 = 60 \text{ volts}$$

## TW-75 AMPLIFIER

### PARTS LIST

- L 1—National AR-16 10-20-40-80 meter—center link
- L 2 B & W 10-20-40-80 meter TVL coils
- C1—Johnson 50F20
- C2—Johnson 100 DD70
- C3—.001—1000V mica
- C4, C5—.006—600V mica
- C6—.0005—500V mica
- NC—Bud—NC1000
- R1—Ohmite 2500 ohm 50 watt No. 0575
- T 1—Thordarson No. 19F94 7.5V 8A
- M1—Triplet No. 327A O-100 Ma.
- M2—Triplet No. 327A O-500 Ma.
- R.F.C.—20 turns No. 16 Push back wire 1" D close wound and supporting. Any manufactured choke with 300 Ma. rating will satisfactory.

### OTHER PARTS

- 1 Chassis 12"x5"x1"
- 1 Johnson No. 252 Shaft coupler
- 2 Johnson No. 256 Panel bearing and shaft
- 2 Johnson No. 40 Insulator
- 1 Miller No. 37101 Safety high voltage terminal
- 1 Millen No. 37105 Steatite terminal strip
- 4 Millen No. 36001 Isolantite plate caps
- 2 Millen No. 39001 Shaft couplers
- 10 National GS5 Cone insulators
- 2 National Type "O" dials
- 1 National X B 16 Socket
- 1 Bud No. PS1257A 14" panel
- 1 Bud MB 459 Panel brackets
- 1 B & W TVL Unit
- 2 Amphenol 4 prong sockets
- 2 Brass rods ¾" dia x 3" long, threaded on both ends for ½" 10 screws
- 1 Brass rod ¼" dia. x 2" long
- 2 Boston Gear Co. No. G465 Miter gears

### SHORT WAVE THERAPY

IT IS NOT THE POLICY OF TAYLOR TUBES, INC., to furnish circuit diagrams for Short Wave Therapy to the casual experimenter; however, bona-fide manufacturers will find our engineers willing and anxious to offer suggestions for bettering the performance of their equipment.

Amateur Radio Operators have, for several years, obtained MORE WATTS PER DOLLAR from the use of TAYLOR TUBES in their transmitters; likewise Short Wave Therapy manufacturers using TAYLOR TUBES in their equipment are reaping the same benefit.

We cannot emphasize too strongly the necessity for careful, conservative engineering and exhaustive tests, as it has been our experience that this is the only procedure that will give satisfaction to both manufacturer and user.

### TUBE INSTALLATION HINTS

The heart of a vacuum tube is its filament. Improper operation of the filament will shorten its life.

Although small variations in filament voltage are compensated for in the designing of our tubes, most satisfactory results are obtained when filaments are operated at their rated voltage. Lower voltage limits the electron emission of the filament and generally results in the over heating of the tube, while higher voltage will rapidly dissipate the supply of thorium in the filament.

Use sockets with large sweeping contacts. Poor contact between socket springs and tube prongs will cause a drop in filament voltage. Heavy well soldered leads are very essential. Light tube at rated filament voltage for ten minutes before applying plate voltage for the first time. Preheating of filament after first installation is not necessary.



# Taylor Tubes

## TW-75

500 WATT  
CLASS C AMPLIFIER

Also Can Be Used with  
T-40, T-55, T-125, TW-150 TUBES  
Modern—Compact—Efficient

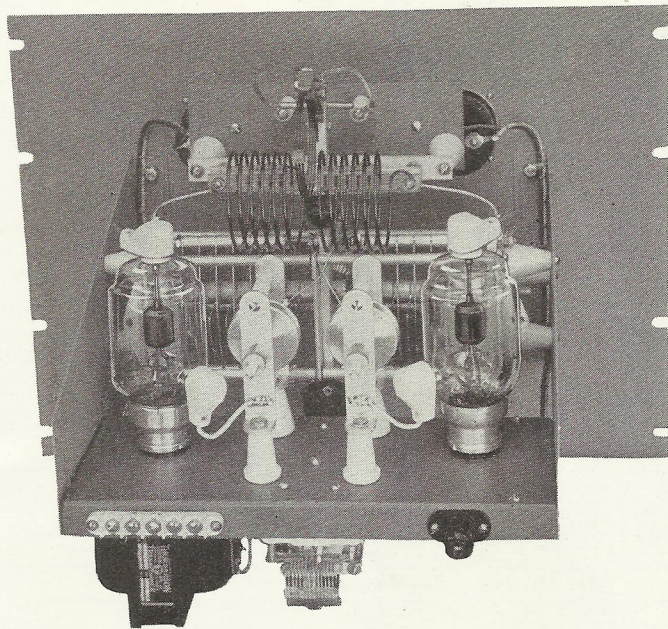

Top View  
TW-75 AMPLIFIER

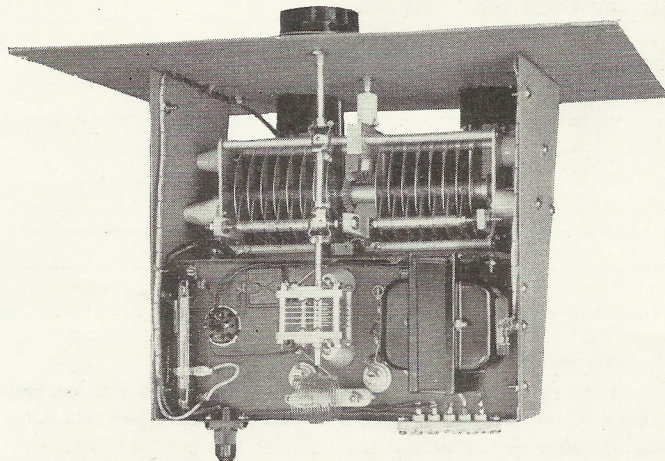

Bottom View  
Note the gears at the center of the Condensers

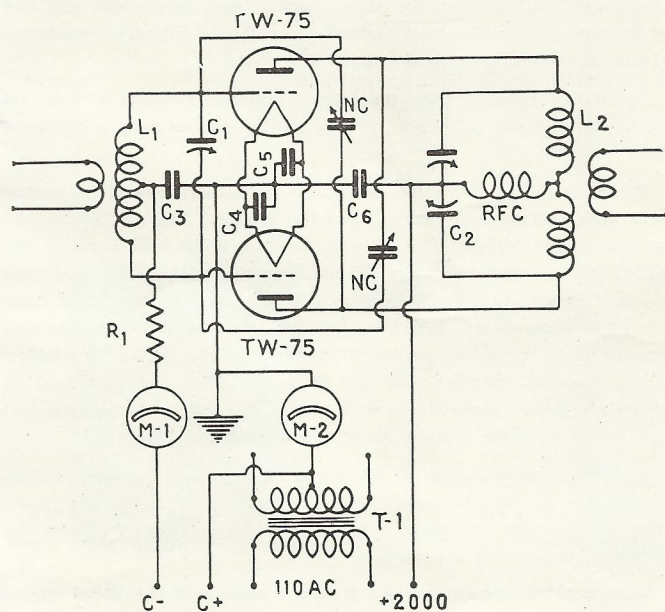

TW-75 AMPLIFIER DIAGRAM  
Parts list on page to the left

Recently there have appeared on the market several push pull amplifier kits to be used with moderate power tubes. The newer ideas of design generally eliminate the convention chassis and use the various component parts along with insulators, angle brackets, etc., to hold the unit together mechanically. Certain advantages can be secured from this type of construction, such as short leads, reduced capacity to ground and lighter weight.

We have constructed an amplifier along these lines which is an excellent performer from 30 mc to 3.5 mc.

It is shown here in order to give amateurs an idea of how to construct a similar amplifier or an exact duplicate.

The amplifier is built around a Johnson 100 DD70 condenser. First the 100 DD70 was altered for center drive by placing a Boston Gear No. G465 miter between the rotor section and driving it in the center with the same type gear. Since the ratio is 1 to 1 the standard dials will indicate properly. With the condenser driven in the center we are off to a good start to good symmetry.

The condenser is mounted between two 11 inch Bud panel brackets. Since the DC must be blocked off the tuning condenser for high voltage operation, it is necessary to insulate the frame from ground. National type GS5 cone insulators are attached to the end plates of the condenser frame. The panel brackets are then attached to the cone insulator which makes a very rigid support. The space between the brackets will be exactly 12 inches. A small chassis, size 5"x12"x1" is used to mount the tube sockets, grid lead, filament transformer, grid tank circuit, neutralizing condenser, etc. This chassis mounted to the rear of the tuning condenser as shown in the photograph. The neutralizing condensers are Bud type NC1000 and are mounted on one National GS5 cone insulator and one Johnson No. 40 feed through insulator. The feed through serves as a lead from the grid tank circuit to the grid of the tube as well as the grid connection to the neutralizing condenser. The grid condensers are mounted in the center just to the rear of the grid coil and are attached with two National GS5 insulators.

After this is completed the unit is attached to a Bud 14" relay rack panel. The distance from the bottom of panel to the bottom of the panel brackets is 3 1/8 inches. This allows just enough room to hang the filament transformer under the chassis so as to not extend below the base line of the amplifier.

The plate coil is a B & W TVL and is attached to the panel by 3 inch stand off pillars. The meters are mounted so that the screws holding the TVL mounting pillars are covered on the front of the panel. By the upper inside corner of the meter coil. Johnson panel bearing with 3 inch shaft No. 256 used for both dials. The upper dial is coupled to the plate tuning condenser through a Johnson No. 252 solid insulated coupling. The grid tuning dial must be mounted slightly above the shaft of the grid condenser. The new Millen Universal joint shaft couplers are used here to drive the grid condensers.

The high voltage is connected to the amplifier by a Millen 37001 Safety terminal which allows easy removal of high voltage for neutralization. The bias, excitation and ground connections are brought out on a Millen No. 37105 steatite terminal strip.

AC voltage for the filament transformer primary is connected direct to the terminal board on the transformers as this is just as handy as using an additional terminal strip.

This amplifier will work out equally well using the other popular Taylor types such as T-40, T-55, T-125, TW-150. The values of components would remain the same except for necessary socket and filament changes.

Parts List on page to the left



# Taylor



# Tubes

## TUBE TYPE COMPARISON CHART

TAYLOR	RCA	WESTERN ELECTRIC	UNITED	AMPEREX	GE
203A	203A	295A	303A	203A	—
211	211	242A	311T	211D	FP197
211C	—	261A } 276A }	361A } 276A } 311CT }	261A } 276A } 211C }	FP285
211D	211	242A	311T	211D	FB197
HD203A	—	—	—	203H	—
HD203C	—	—	303U	—	—
HD211C	—	—	311CH	211H	—
303C	—	—	303CU	203H	FP198
805	805	—	905	805	—
814	*	—	HV12	—	—
822	—	—	HV27	—	—
830B	830B	—	930B	—	—
838	838	—	938	—	—
845	845	284A	945	845	—
T200	—	—	HV18	FP252	—
866	866	—	966	866	—
872A	872A	—	972A	872A	—
249B	—	249B	—	249B	—

\*Taylor 814 and RCA 814 are not similar types.

### DANGER—HIGH VOLTAGE

Courtesy Radio Handbook—1938 Edition

The high voltage power supplies even in a low power transmitter are potentially lethal. They are also potential fire hazards. Pages could be written on "don'ts" and precautionary measures, but the important thing is to **use your head**; don't fool with any part of your transmitter or power supply unless you know exactly what you are doing and have your mind on what you are doing.

Not only should your transmitter installation be so arranged to minimize the danger of accidental shock for your own safety, but also because "haywire" installations that do not pass the underwriter's rules will invalidate your fire insurance. You have no claim against the insurance company if they can prove that the installation did not meet the underwriters' specifications.

Some of the most important things to remember in regard to the high voltage danger are the following:

**Do not rely upon bleeders to discharge your filter condensers; short the condenser with an insulated-handle screwdriver before handling any of the associated circuits. Bleeders occasionally blow out, and good filter condensers hold a charge a long time.**

Beware of "zero adjuster" devices on meters placed in positive high voltage leads. Also be careful of dial set screws if the rotor shaft of the condenser is "hot." Both of these situations represent poor practice to begin with.

Don't touch any transmitter components without first turning off all switches. If you do insist on making coupling adjustments, etc., with the transmitter on (very bad practice), keep **ONE HAND BEHIND YOU**.

Do not work on the high voltage circuits or make adjustments where it is necessary to reach inside the transmitter **UNLESS SOMEONE ELSE IS PRESENT**. 90% of the deaths of amateurs due to electrocution could

have been prevented if someone had been present to kill the high voltage or remove the victim and to call the doctor and administer first aid before he arrived.

High voltage gear should be so fixed that small children cannot manipulate the switches or come in contact with any of the wires or components. Either keep the radio room or gear under lock and key or else provide an "interlock" system whereby all primary circuits are broken when the transmitter cabinet is opened.

Familiarize yourself with the latest approved methods of first aid treatment for electrical shock. It may enable you to save a life some time.

Don't attempt to hurry too much if a companion comes in contact with high voltage and cannot extricate himself. Act quickly but do not act without deliberation or you may be in as bad a fix as the person you are trying to help. Do not touch the victim with your bare hands if things are wet. Otherwise it is safe to grab him by a loose fold of clothing to pull him free, first making sure that you are well insulated from anything grounded. Turning off the voltage is simpler, when possible. However, do not waste precious moments dashing around trying to discover how to open the circuit. If you do not already know, try to remove the victim if it can be done safely.

A main primary switch at the entrance to the radio room, killing all primary circuits, will reduce the fire hazard and help your peace of mind, provided you make it an iron-clad rule always to throw the switch when leaving the room.

Beware of strange equipment. It may contain unconventional wiring or circuits. Do not take for granted that it is wired the way you would do it.



**W**E wish to sincerely thank these manufacturers who have so generously cooperated with our Engineering Staff in the building of the transmitters described in this manual. We have found their products to be of the best quality and recommend their use very highly.

American Phenolic Co.  
Barker-Williamson Coils  
Bliley Crystals  
Bud Radio, Inc.  
Cardwell Condensers  
Cornell-Dubilier  
Gordon Nameplates  
Hammarlund  
Hi-Power Crystals  
E. F. Johnson Co.  
Kelvin Holders  
Kenyon Transformers  
Lenz Electric Mfg. Co.

James Millen Co.  
Meisner Mfg. Co.  
National Co.  
Ohmite Resistors  
Simpson Meters  
Stancor Transformers  
Thordarson Transformers  
Turner Microphones  
Triplett Meters  
UTC Transformers  
Ward Leonard Relays

Other Circuits using Taylor Tubes can be found in the following publications:

814 Grid Mod. 100 watt Xmtr—Jan. 1937 Radio.	56 mc. Xmtr.—Exciter—Jan. 1939 Radio.
T20's Band Xmtr—Mar. 1937 Radio.	T20 Jones—Jan. 1939 Radio.
T55 Xmtr—Jan. 1937 QST.	T40's March 1939 Radio.
10 to 160 meter Xmtr—June 1937 QST.	T-21—W8QZR—Jan. 1940 Radio.
ARRL and Radio Handbooks	TW-150 Bishop—Nov. 1939 QST.
TZ40—Keim—Dec. 1939 QST.	T21 Goodman—Feb. 1940 QST.
TZ20—6 Band Xmtr. Feb. 1939 QST.	T-125 Morgan—Nov. 1939 Radio.
T200—Ferrill—Sept. 1939 QST.	

---

Taylor Tubes are used in Bassett, Harvey, Gross, Link, Motorola and Temco Transmitters

## **TAYLOR TUBES, Inc.**

**2341-43 Wabansia Avenue - Chicago**

Foreign Representative  
**ROYAL NATIONAL CO.**  
Cable NATVARNCO  
89 Broad Street  
New York City

# **TUBES WITH A REAL GUARANTEE**

PRINTED IN U. S. A.



GENTRY PRINTING COMPANY



*“More*

*Watts*

*Per*

*Dollar”*

*with*

*Taylor*

CUSTOM  
BUILT

*Tubes*

**RECOMMENDED AND DISTRIBUTED BY**

DISTRIBUTED BY

**SUN RADIO CO.**

212 FULTON STREET

(BET. CHURCH & GREENWICH ST.)

NEW YORK CITY

PHONES BA 7-7647-8