

Contents

ELECTRONS, ELECTRODES, AND ELECTRON TUBES Electrons, Cathodes, Generic Tube Types, Diodes, Triodes, Tetrodes, Pentodes, Beam Power Tubes, Multi-Electrode and Multi-Unit Types, Receiving Tube Structure, Television Picture Tubes	PAGE 3
ELECTRON TUBE CHARACTERISTICS	12
ELECTRON TUBE APPLICATIONS Amplification, Rectification, Detection, Automatic Volume or Gain Control, Tuning Indication with Electron-Ray Tubes, Oscillation, De- flection Circuits, Frequency Conversion, Automatic Frequency Control	14
ELECTRON TUBE INSTALLATION Filament and Heater Power Supply, Heater-to-Cathode Connection, Plate Voltage Supply, Grid Voltage Supply, Screen-Grid Voltage Supply, Shielding, Dress of Circuit Leads, Filters, Output-Coupling Devices, High-Fidelity Systems, High-Voltage Considerations for Television Picture Tubes, Picture-Tube Safety Considerations	58
INTERPRETATION OF TUBE DATA	69
APPLICATION GUIDE FOR RCA RECEIVING TUBES	75
TECHNICAL DATA FOR RCA TUBE TYPES	83
PICTURE-TUBE CHARACTERISTICS CHART	484
ELECTRON TUBE TESTING	487
RESISTANCE-COUPLED AMPLIFIERS	491
OUTLINES	500
CIRCUITS	504
INDEX	536
READING LIST	544

Information furnished by RCA is believed to be accurate and reliable. However, no responsibility is assumed by RCA for its use; nor for any infringements of patents or other rights of third parties which may result from its use. No license is granted by implication or otherwise under any patent or patent rights of RCA.

RCA Receiving Tube Manual

THIS MANUAL, like its preceding editions, has been prepared to assist those who work or experiment with home-entertainment-type electron tubes and circuits. It will be found valuable by engineers, service technicians, educators, experimenters, radio amateurs, hobbyists, students, and many others technically interested in electron tubes.

The material in this edition has been augmented and revised to include the recent technological advances in the electronics field. Many tube types widely used in the design of new electronic equipment only a few years ago are now chiefly of interest for renewal purposes. Consequently, in the Tube Types Section, information on many older types is limited to basic essential data; information on newer and more important types is given in greater detail.

Electrons, Electrodes, and Electron Tubes

The electron tube is a marvelous device. It makes possible the performing of operations, amazing in conception, with a precision and a certainty that are astounding. It is an exceedingly sensitive and accurate instrument—the product of coordinated efforts of engineers and craftsmen. Its construction requires materials from every corner of the earth. Its use is world-wide. Its future possibilities, even in the light of present-day accomplishments, are but dimly foreseen, for each development opens new fields of design and application.

The importance of the electron tube lies in its ability to control almost instantly the flight of the millions of electrons supplied by the cathode. It accomplishes this control with a minimum of energy. Because it is almost instantaneous in its action, the electron tube can operate efficiently and accurately at electrical frequencies much higher than those attainable with rotating machines.

Electrons

All matter exists in the solid, liquid, or gaseous state. These three forms consist entirely of minute divisions known as molecules, which, in turn, are composed of atoms. Atoms have a nucleus which is a positive charge of electricity, around which revolve tiny charges of negative electricity known as electrons. Scientists have estimated that electrons weigh only 1/30-billion, billion, billion, billionths of an ounce, and that they may travel at speeds of thousands of miles per second.

Electron movement may be accelerated by the addition of energy. Heat is one form of energy which can be conveniently used to speed up the electron. For example, if the temperature of a metal is gradually raised, the electrons in the metal gain velocity. When the metal becomes hot enough, some electrons may acquire sufficient speed to

break away from the surface of the metal. This action, which is accelerated when the metal is heated in a vacuum, is utilized in most electron tubes to produce the necessary electron supply.

An electron tube consists of a cathode, which supplies electrons, and one or more additional electrodes, which control and collect these electrons, which are in an evacuated envelope. The envelope may be made of glass, metal, ceramic, or a combination of these materials.

Cathodes

A cathode is an essential part of an electron tube because it supplies the electrons necessary for tube operation. When energy in some form is applied to the cathode, electrons are released. Heat is the form of energy generally used. The method of heating the cathode may be used to distinguish between the different forms of cathodes. For example, a directly heated cathode, or filament-cathode, is a wire heated by the passage of an electric current. An indirectly heated cathode, or heater-cathode, consists of a filament, or heater, enclosed in a metal sleeve. The sleeve carries the electron-emitting material on its outside surface and is heated by radiation and conduction from the heater.

A filament, or directly heated cathode, such as that shown in Fig. 1 may be further classified by identifying the filament or electron-emitting material. The materials in regular use are tungsten, thoriated tungsten, and metals which have been coated with alkaline-earth oxides. Tungsten filaments are made from the pure metal. Because they must operate at high temperatures (a dazzling white) to emit sufficient electrons, a relatively large amount of filament power is required.

Thoriated-tungsten filaments are made from tungsten impregnated with thorium oxide. Due to the presence of

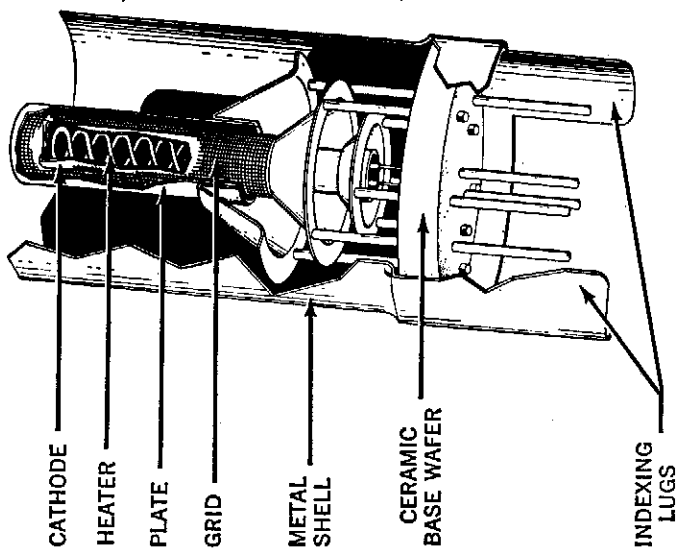

NUVISTOR TRIODE

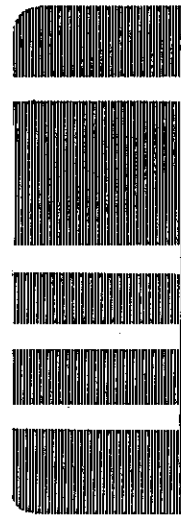

therium, these filaments liberate electrons at a more moderate temperature of about 1700°C (a bright yellow) and are, therefore, much more economical of filament power than are pure tungsten filaments.

Alkaline earths are usually applied as a coating on a nickel-alloy wire or ribbon. This coating, which is dried in a relatively thick layer on the filament, requires only a relatively low temperature of about 700-750°C (a dull red) to produce a copious supply of electrons. Coated filaments operate very efficiently and require relatively little filament power. However, each of these cathode materials has special advantages which determine the choice for a particular application.

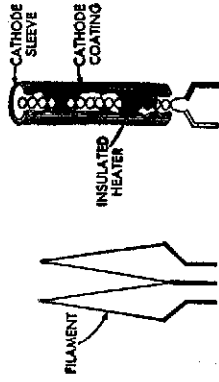

Fig. 1

Directly heated filament-cathodes require comparatively little heating power. They are used in almost all of the tube types designed for battery operation because it is, of course, desirable to impose as small a drain as possible on the batteries. Examples of battery-operated filament types are the 1R5, 1U4, 1U5, and 3V4. AC-operated types having directly heated filament-cathodes include the 2A3 and 5Y3GT.

An indirectly heated cathode, or heater-cathode, consists of a thin metal sleeve coated with electron-emitting material such as alkaline-earth oxides. The emissive surface of the cathode is maintained at the required temperature (approximately 1050°K) by resistance-heating of a tungsten or tungsten-alloy wire which is placed inside the cathode sleeve and electrically insulated from it, as shown in Fig. 2. The heater is used only for the purpose of heating the cathode sleeve and sleeve coating to an electron-emitting temperature. Useful emission does not take place from the heater wire.

A new dark heater insulating coating developed by RCA has better heat transfer than earlier aluminum-oxide coatings, and makes it possible to operate heaters at lower temperatures for given power inputs. Because the tensile strength of the heater wire increases at the lower operating temperatures, tubes using dark heaters have increased reliability, stability, and life.

The heater-cathode construction is well adapted for use in electron tubes intended for operation from ac power lines and from storage batteries. The use of separate parts for emitter and heater functions, the electrical insulation of the heater from the emitter, and the shielding effect of the sleeve may all be utilized in the design of the tube to minimize the introduction of hum from the ac heater supply and to minimize electrical interference which might enter the tube circuit through the heater-supply line. From the viewpoint of circuit design, the heater-cathode construction offers advantages in connection flexibility because of the electrical separation of the heater from the cathode.

Another advantage of the heater-cathode construction is that it makes practical the design of a rectifier tube having close spacing between its cathode and plate, and of an amplifier tube having close spacing between its cathode and grid. In a close-spaced rectifier tube, the voltage drop in the tube is low, and, therefore, the regulation is improved. In an amplifier tube, the close spacing increases the gain obtainable from the tube. Because of the advantages of the heater-cathode construction, almost all present-day receiving tubes designed for ac operation have heater-cathodes.

Generic Tube Types

Electrons are of no value in an electron tube unless they can be put to work. Therefore, a tube is designed with the parts necessary to utilize electrons as well as those required to produce them. These parts consist of a cathode and one or more supplementary electrodes. The electrodes are enclosed in an evacuated envelope having the necessary connections brought out through air-tight seals. The air is removed from the envelope to allow free movement of

other tubes in the receiver. Rectifier tubes having only one plate and one cathode, such as the 35W4, are called half-wave rectifiers, because current can flow only during one-half of the alternating-current cycle. When two plates and one or more cathodes are

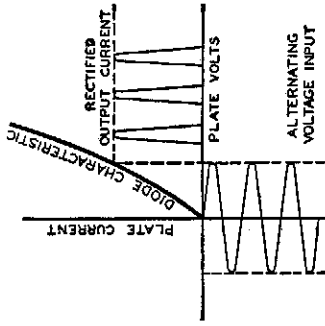

Fig. 4

used in the same tube, current may be obtained on both halves of the ac cycle. The 6X4, 6Y3GT, and 5U4GB are examples of this type and are called full-wave rectifiers.

Not all of the electrons emitted by the cathode reach the plate. Some return to the cathode while others remain in the space between the cathode and plate for a brief period to produce an effect known as space charge. This charge has a repelling action on other electrons which leave the cathode surface and impedes their passage to the plate. The extent of this action and the amount of space charge depend on the cathode temperature, the distance between the cathode and the plate, and the plate potential. The higher the plate potential, the less is the tendency for electrons to remain in the space-charge region and repel other electrons. This effect may be noted by applying increasingly higher plate voltages to a tube operating at a fixed heater or filament voltage. Under these conditions, the maximum number of available electrons is fixed, but increasingly higher plate voltages will succeed in attracting a greater proportion of the free electrons.

Beyond a certain plate voltage, however, additional plate voltage has little effect in increasing the plate current because all of the electrons emitted

the electrons and to prevent injury to the emitting surface of the cathode.

When the cathode is heated, electrons leave the cathode surface and form an invisible cloud in the space around it. Any positive electric potential within the evacuated envelope offers a strong attraction to the electrons (unlike electric charges attract; like charges repel). Such a positive electric potential can be supplied by an anode (positive electrode) located within the tube in proximity to the cathode.

Diodes

The simplest form of electron tube contains two electrodes, a cathode and an anode (plate), and is often called a diode, the family name for a two-electrode tube. In a diode, the positive potential is supplied by a suitable electrical source connected between the plate terminal and a cathode terminal, as shown in Fig. 3. Under the influence of

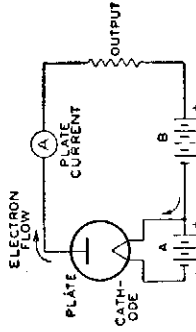

Fig. 3

the positive plate potential, electrons flow from the cathode to the plate and return through the external plate-battery circuit to the cathode, thus completing the circuit. This flow of electrons is known as the plate current.

If a negative potential is applied to the plate, the free electrons in the space surrounding the cathode will be forced back to the cathode and no plate current will flow. If an alternating voltage is applied to the plate, the plate is alternately made positive and negative. Because plate current flows only during the time when the plate is positive, current flows through the tube in only one direction and is said to be rectified. Fig. 4 shows the rectified output current produced by an alternating input voltage.

Diode rectifiers are used in ac receivers to convert the ac supply voltage to dc voltage for the electrodes of the

by the cathode are already being drawn to the plate. This maximum current, illustrated in Fig. 5, is called saturation current. Because it is an indication of the total number of electrons emitted, it is also known as emission current or simply emission.

Although tubes are sometimes tested by measurement of their emission current, it is generally not advisable to measure the full value of emission because this value would be sufficiently large to cause change in the tube's characteristics or even to damage the tube. Consequently, while the best value of emission current is somewhat larger than

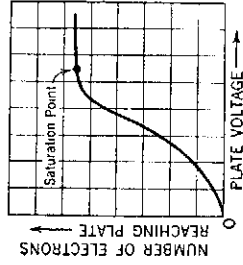

Fig. 5

the maximum current which will be required from the cathode in the use of the tube, it is ordinarily less than the full emission current. The emission test, therefore, is used to indicate whether the cathode can supply a sufficient number of electrons for satisfactory operation of the tube.

If space charge were not present to repel electrons coming from the cathode, the same plate current could be produced at a lower plate voltage. One way to make the effect of space charge small is to make the distance between plate and cathode small. This method is used in rectifier types having heater-cathodes, such as the 5V4GA and the 6AX5GT. In these types the radial distance between cathode and plate is only about two hundredths of an inch.

Another method of reducing space-charge effect is utilized in mercury-vapor rectifier tubes. When such tubes are operated, a small amount of mercury contained in the tube is partially vaporized, filling the space inside the bulb with mercury atoms. These atoms are

bombarded by electrons on their way to the plate. If the electrons are moving at a sufficiently high speed, the collisions tear off electrons from the mercury atoms. The mercury atom is then said to be "ionized," i.e., it has lost one or more electrons and, therefore, has a positive charge. Ionization is evidenced by a bluish-green glow between the cathode and plate. When ionization occurs, the space charge is neutralized by the positive mercury atoms so that increased numbers of electrons are made available. Mercury-vapor tubes are used primarily for power rectifiers.

Ionic-heated-cathode rectifiers depend on gas ionization for their operation. These tubes are of the full-wave design and contain two anodes and a coated cathode sealed in a bulb containing a reduced pressure of inert gas. The cathode in each of these types becomes hot during tube operation, but the heating effect is caused by bombardment of the cathode by ions within the tube rather than by heater or filament current from an external source.

The internal structure of an ionic-heated-cathode tube is designed so that when sufficient voltage is applied to the tube, ionization of the gas occurs between the anode which is instantaneously positive and the cathode. Under normal operating voltages, ionization does not take place between the anode that is negative and the cathode so that the requirements for rectification are satisfied. The initial small flow of current through the tube is sufficient to raise the cathode temperature quickly to incandescence whereupon the cathode emits electrons. The voltage drop in such tubes is slightly higher than that of the usual hot-cathode gas rectifiers because energy is taken from the ionization discharge to keep the cathode at operating temperature. Proper operation of these rectifiers requires a minimum flow of load current at all times in order to maintain the cathode at the temperature required to supply sufficient emission.

Triodes

When a third electrode, called the grid, is placed between the cathode and plate, the tube is known as a triode, the family name for a three-electrode tube.

electrode acting as one plate of a small capacitor. The capacitances are those existing between grid and plate, plate and cathode, and grid and cathode. These capacitances are known as inter-electrode capacitances. Generally, the capacitance between grid and plate is of the most importance. In high-gain radio-frequency amplifier circuits, this capacitance may act to produce undesired coupling between the input circuit, the circuit between grid and cathode, and the output circuit, the circuit between plate and cathode. This coupling is undesirable in an amplifier because it may cause instability and unsatisfactory performance.

Tetrodes

The capacitance between grid and plate can be made small by mounting an additional electrode, called the screen grid (grid No. 2), in the tube. With the addition of the grid No. 2, the tube has four electrodes and is, accordingly, called a tetrode. The screen grid or grid No. 2 is mounted between the grid No. 1 (control grid) and the plate, as shown in Fig. 7, and acts as an electrostatic shield between them, thus reducing the grid-to-plate capacitance. The effectiveness of

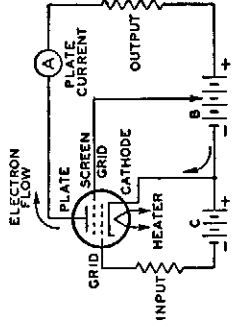

Fig. 7

this shielding action is increased by a bypass capacitor connected between screen grid and cathode. By means of the screen grid and this bypass capacitor, the grid-plate capacitance of a tetrode is made very small. In practice, the grid-plate capacitance is reduced from several picofarads (pf) for a triode to 0.01 pf or less for a screen-grid tube.

The screen grid has another desirable effect in that it makes plate current practically independent of plate voltage over a certain range. The screen grid is operated at a positive voltage and,

The grid usually consists of relatively fine wire wound on two support rods (siderods) and extending the length of the cathode. The spacing between turns of wire is large compared with the size of the wire so that the passage of electrons from cathode to plate is practically unobstructed by the grid. In some types, a frame grid is used. The frame consists of two siderods supported by four metal straps. Extremely fine lateral wire (diameter of 0.5 mil or less) is wound under tension around the frame. This type of grid permits the use of closer spacings between grid wires and between tube electrodes, and thus improves tube performance.

The purpose of the grid is to control the flow of plate current. When a tube is used as an amplifier, a negative dc voltage is usually applied to the grid. Under this condition the grid does not draw appreciable current.

The number of electrons attracted to the plate depends on the combined effect of the grid and plate polarities, as shown in Fig. 6. When the plate is positive, as is normal, and the dc grid voltage is made more and more negative, the plate is less able to attract electrons to it and plate current decreases. When the

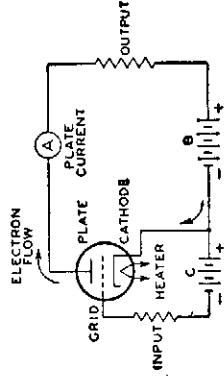

Fig. 6

grid is made less and less negative (more and more positive), the plate more readily attracts electrons to it and plate current increases. Hence, when the voltage on the grid is varied in accordance with a signal, the plate current varies with the signal. Because a small voltage applied to the grid can control a comparatively large amount of plate current, the signal is amplified by the tube. Typical three-electrode tube types are the 6C4 and 6AP4A.

The grid, plate, and cathode of a triode form an electrostatic system, each

therefore, attracts electrons from the cathode, because of the comparatively large space between wires of the screen grid, most of the electrons drawn to the screen grid pass through it to the plate. Hence the screen grid supplies an electrostatic force pulling electrons from the cathode to the plate. At the same time the screen grid shields the electrons between cathode and screen grid from the plate so that the plate exerts very little electrostatic force on electrons near the cathode.

So long as the plate voltage is higher than the screen-grid voltage, plate current in a screen-grid tube depends to a great degree on the screen-grid voltage and very little on the plate voltage. The fact that plate current in a screen-grid tube is largely independent of plate voltage makes it possible to obtain much higher amplification with a tetrode than with a triode. The low grid-plate capacitance makes it possible to obtain this high amplification without plate-to-grid feedback and resultant instability. In receiving-tube applications, the tetrode has been replaced to a considerable degree by the pentode.

Pentodes

In all electron tubes, electrons striking the plate may, if moving at sufficient speed, dislodge other electrons. In two- and three-electrode types, these dislodged electrons usually do not cause trouble because no positive electrode other than the plate itself is present to attract them. These electrons, therefore, are drawn back to the plate. Emission caused by bombardment of an electrode by electrons from the cathode is called secondary emission because the effect is secondary to the original cathode emission.

In the case of screen-grid tubes, the proximity of the positive screen grid to the plate offers a strong attraction to these secondary electrons and particularly so if the plate voltage swings lower than the screen-grid voltage. This effect lowers the plate current and limits the useful plate-voltage swing for tetrodes.

The effects of secondary emission are minimized when a fifth electrode is placed within the tube between the screen grid and plate. This fifth electrode is known as the suppressor grid (grid

No.3) and is usually connected to the cathode, as shown in Fig. 8. Because of its negative potential with respect to the plate, the suppressor grid retards the flight of secondary electrons and diverts them back to the plate.

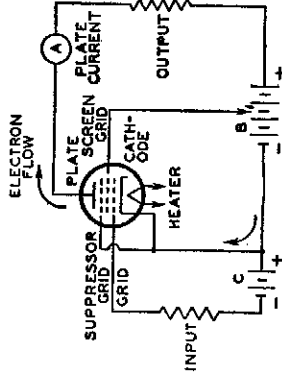

Fig. 8

The family name for a five-electrode tube is "pentode". In power-output pentodes, the suppressor grid makes possible higher power output with lower grid-driving voltage; in radio-frequency amplifier pentodes the suppressor grid makes possible high voltage amplification at moderate values of plate voltage. These desirable features result from the fact that the plate-voltage swing can be made very large. In fact, the plate voltage may be as low as, or lower than, the screen-grid voltage without serious loss in signal-gain capability. Representative pentodes used for power amplification are the 3V4 and 6K6GT; representative pentodes used for voltage amplification are the 1U4, 6AU6A, 6BA6, and 5879.

Beam Power Tubes

A beam power tube is a tetrode or pentode in which directed electron beams are used to increase substantially the power-handling capability of the tube.

Such a tube contains a cathode, a control grid (grid No.1), a screen grid (grid No.2), a plate, and, optionally, a suppressor grid (grid No.3). When a beam power tube is designed without an actual suppressor grid, the electrodes are so spaced that secondary emission from the plate is suppressed by space-charge effects between screen grid and plate. The space charge is produced by the slowing up of electrons traveling from a high-potential screen grid to a lower-potential plate. In this low-velocity region, the space charge produced is suffi-

screen grid outside of the beam. The space-charge effect may also be obtained by use of an actual suppressor grid. Examples of beam power tubes are 6AQ5A, 6L5GB, 6V6GT, and 50C6.

Multi-Electrode and Multi-Unit Tubes

Early in the history of tube development and application, tubes were designed for general service; that is, a single tube type—a triode—was used as a radio-frequency amplifier, an intermediate-frequency amplifier, an audio-frequency amplifier, an oscillator, or a detector. Obviously, with this diversity of application, one tube did not meet all requirements to the best advantage.

Later and present trends of tube design are the development of "specialty" types. These types are intended either to give optimum performance in a particular application or to combine in one bulb functions which formerly required two or more tubes. The first class of tubes includes such examples of specialty types as the 6CB6 and 6BY6. Types of this class generally require more than three electrodes to obtain the desired special characteristics and may be broadly classed as multi-electrode types. The 6BY6 is an especially interesting type in this class. This tube has an unusually large number of electrodes, namely seven, exclusive of the heater. Plate current in the tube is varied at two different frequencies at the same time. The tube is designed primarily for use as a combined sync separator and sync clipper in television receivers.

The second class includes multi-unit tubes such as the twin-diode triodes 6BF6 and 6AV6, as well as triode-pentodes such as the 6USA and 6X8. This class also includes class A twin triodes such as the 6CG7 and 12AX7, and types such as the 6CM7 containing dissimilar triode units used primarily as combined vertical oscillators and vertical deflection amplifiers in television receivers. Full-wave rectifiers are also multi-unit types.

A third class of tubes combines features of each of the other two classes. Typical of this third class are the pentagrid-converter types 1R5, 6BE6, and 6SA7. These tubes are similar to the

cient to repel secondary electrons emitted from the plate and to cause them to return to the plate.

Beam power tubes of this design employ beam-confining electrodes at cathode potential to assist in producing the desired beam effects and to prevent stray electrons from the plate from returning to the screen grid outside of the beam. A feature of a beam power tube is its low screen-grid current. The screen grid and the control grid are spiral wires wound so that each turn of the screen grid is shaded from the cathode by a grid turn. This alignment of the screen grid and control grid causes the electrons to travel in sheets between the turns of the screen grid so that very few of them strike the screen grid. Because of the effective suppressor action provided by space charge and because of the low current drawn by the screen grid, the beam power tube has the advantages of high power output, high power sensitivity, and high efficiency.

Fig. 9 shows the structure of a beam power tube employing space-charge suppression and illustrates how the electrons

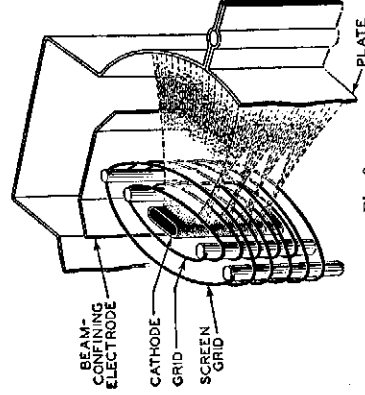

Fig. 9

are confined to beams. The beam condition illustrated is that for a plate potential less than the screen-grid potential. The high-density space-charge region is indicated by the heavily dashed lines in the beam. Note that the edges of the beam-confining electrodes coincide with the dashed portion of the beam. In this way the space-charge potential region is extended beyond the beam boundaries and stray secondary electrons are prevented from returning to the

multi-electrode types in that they have seven electrodes, all of which affect the electron stream; and they are similar to the multi-unit tubes in that they perform simultaneously the double function of oscillator and mixer in superheterodyne receivers.

Receiving Tube Structure

Receiving tubes generally utilize a glass or metal envelope and a base. Originally, the base was made of metal or molded phenolic material. Types having a glass envelope and a molded phenolic base include the "octal" types such as the 5U4GB and the 6SN7GTB. Types having a metal envelope and molded phenolic octal base include the 6AC7 and the 6AG7. Many modern types utilize integral glass bases. Present-day conventional tube designs utilizing glass envelopes and integral glass bases include the seven-pin and nine-pin miniature types; the nine-pin novar and neonovar types, and the twelve-pin duodecarr types. Examples of the seven-pin miniature types are the 6AU6A and 6BN6. Examples of the nine-pin miniature types are the 12AU7A and 6EA8. Examples of the novar types are the 6BH8 and 7868. The nine-pin base for the novar types has a relatively large pin-circle diameter and long pins to insure firm retention of the tube in its socket.

The nuvistor concept provided a new approach to electron tube design.

Nuvisor tubes utilize a light-weight cantilever-supported cylindrical electrode structure housed in a ceramic-metal envelope (see page 2 for cutaway view). These tubes combine new materials, processes, and fabrication techniques. Examples of the nuvistor are the 2CW4 and the 6CW4.

Television Picture Tubes

The picture tube, or kinescope, is a multi-electrode tube used principally in television receivers for picture display. It consists essentially of an electron gun, a glass or metal-and-glass envelope and a face-plate combination, and a fluorescent screen.

The electron gun includes a cathode for the production of free electrons, one or more control electrodes for accelerating the electrons in the beam, and, optionally, a device for "trapping" unwanted ions out of the electron beam.

Focusing of the beam is accomplished either electromagnetically by means of a focusing coil placed on the neck of the tube, or electrostatically, as shown in Fig. 10, by means of a focusing electrode (grid No. 4) within the envelope of the tube. The screen is a white-fluorescing phosphor P4 of either the silicate or the sulfide type.

Deflection of the beam is accomplished either electrostatically by means of deflecting electrodes within the envelope of the tube, or electromagnetically

by means of a deflecting yoke placed on the neck of the tube. Fig. 10 shows the structure of the gun section of a picture tube and illustrates how the electron beam is formed and how the beam is deflected by means of an electromagnetic deflecting yoke. In this type of tube, ions in the beam are prevented from damaging the fluorescent screen by an aluminum film on the gun side of the screen. This film not only "traps" unwanted ions, but also improves picture contrast. In many types of non-aluminized tubes, ions are separated from the electron beam by means of a tilted-gun and ion-trap-magnet arrangement.

Color television picture tubes are similar to black-and-white picture tubes, but differ in three major ways. (1) The light-emitting screen is made up of trios of phosphor dots deposited in an interlaced pattern. Each dot of a trio is capable of emitting light in one of the three primary colors (red, green, or blue). (2) A shadow mask mounted near the screen of the tube contains over 300,000 apertures, one for each of the phosphor dot trios. This mask provides color separation by shadowing two of the three phosphor dots of each trio. (3) Three closely spaced electron guns, built as a unit, provide separate beams for excitation of the three different color-phosphor-dot arrays. Thus it is possible to control the brightness of each of the three colors independently of the other two.

The three electron guns are mounted with their axes tilted toward the central axis of the envelope, and are spaced 120 degrees with respect to each other. The focusing electrodes of the three guns are interconnected internally, and their potential is adjusted to cause the separate beams to focus at the phosphor-dot screen. All three beams must be made to converge at the screen while they are simultaneously being deflected, convergence is accomplished by the action of static and dynamic magnetic fields set up by the radial-converging magnet assembly mounted on the neck of the tube. These fields are coupled into the radial-converging pole pieces within the tube. Another pair of pole pieces in the tube is activated by the lateral-converging magnet also mounted on the neck of the tube. These pole pieces permit lateral shift in position of the blue beam in opposition to the lateral shift of the green and red beams.

A purifying magnet is used with color picture tubes to provide a magnetic field, adjustable in magnitude and direction, to effect register over the entire area of the screen. A magnetic shield is used to minimize the effects of the earth's magnetic field.

Deflection of the three beams is accomplished simultaneously by a deflecting yoke consisting of four electromagnetic coils similar to the deflecting yoke used for black-and-white picture tubes.

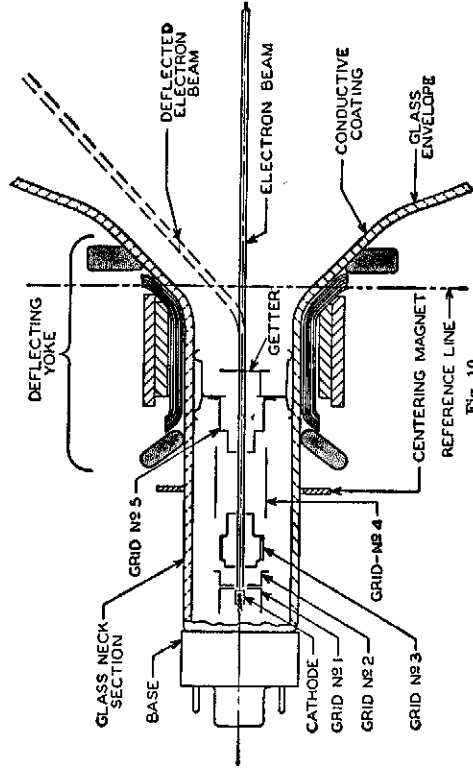

FIG. 10

Electron Tube Characteristics

The term "characteristics" is used to identify the distinguishing electrical features and values of an electron tube. These values may be shown in curve form or they may be tabulated. When the characteristics values are given in curve form, the curves may be used for the determination of tube performance and the calculation of additional tube factors.

Tube characteristics are obtained from electrical measurements of a tube in various circuits under certain definite conditions of voltages. Characteristics may be further described by denoting the conditions of measurements. For example Static Characteristics are the values obtained with different dc potentials applied to the tube electrodes, while Dynamic Characteristics are the values obtained with an ac voltage on a control grid under various conditions of dc potentials on the electrodes. The dynamic characteristics, therefore, are indicative of the performance capabilities of a tube under actual working conditions.

Static characteristics may be shown by plate characteristics curves and transfer (mutual) characteristics curves. These curves present the same information, but in two different forms to increase its usefulness. The plate characteristic curve is obtained by varying plate voltage and measuring plate current for different grid bias voltages, while the transfer-characteristic curve is obtained by varying grid bias voltage and measuring plate current for different plate voltages. A plate-characteristic family of curves is illustrated by Fig. 11. Fig. 12 gives the transfer-characteristic family of curves for the same tube.

Dynamic characteristics include amplification factor, plate resistance, control-grid—plate transconductance, and certain detector characteristics, and may be shown in curve form for variations in tube operating conditions.

The amplification factor, or μ , is the ratio of the change in plate voltage

small change in plate voltage divided by the corresponding change in plate current and is expressed in ohms, the unit of resistance. Thus, if a change of 0.1 milliampere (0.0001 ampere) is produced by a plate voltage variation of 1 volt, the plate resistance is 1 divided by 0.0001, or 10000 ohms.

Control-grid—plate transconductance, or simply **transconductance** (g_m), is a factor which combines in one term the amplification factor and the plate resistance, and is the quotient of the first divided by the second. This term has also been known as mutual conductance. Transconductance may be more strictly defined as the quotient of a small change in plate current (amperes) divided by the small change in the control-grid voltage producing it, under the condition that all other voltages remain unchanged. Thus, if a grid-voltage change of 0.5 volt causes a plate-current change of 1 milliampere (0.001 ampere), with all other voltages constant, the transconductance is 0.001 divided by 0.5, or 0.002 mho. A "mho" is the unit of conductance and was named by spelling ohm backwards. For convenience, a millionth of a mho, or a micromho (amho), is used to express transconductance. Thus, in the example, 0.002 mho

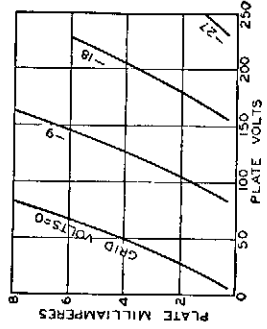

Fig. 11

made 1 volt more positive, the control electrode (grid-No.1) voltage must be made 0.1 volt more negative to hold plate current unchanged, the amplification factor is 1 divided by 0.1, or 10. In other words, a small voltage variation in the grid circuit of a tube has the same effect on the plate current as a large

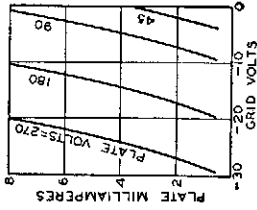

Fig. 12

plate-voltage change—the latter equal to the product of the grid-voltage change and amplification factor. The μ of a tube is often useful for calculating stage gain. This use is discussed in the ELECTRON TUBE APPLICATIONS SECTION.

Plate resistance (r_p) of an electron tube is the resistance of the path between cathode and plate to the flow of alternating current. It is the quotient of a

is 2000 micromhos.

Conversion transconductance (g_c) is a characteristic associated with the mixer (first detector) function of tubes and may be defined as the quotient of the intermediate-frequency (if) current in the primary of the if transformer divided by the applied radio-frequency (rf) voltage producing it; or more precisely, it is the limiting value of this quotient as the rf voltage and if current approach zero. When the performance of a frequency converter is determined, conversion transconductance is used in the same way as control-grid—plate transconductance is used in single-frequency amplifier computations.

The plate efficiency of a power amplifier tube is the ratio of the ac power output (P_o) to the product of the average dc plate voltage (E_b) and dc plate current (I_b) at full signal, or

$$\text{Plate efficiency (\%)} = \frac{P_o \text{ watts}}{E_b \text{ volts} \times I_b \text{ amperes}} \times 100$$

The power sensitivity of a tube is the ratio of the power output to the square of the input signal voltage (E_{in}) and is expressed in mhos as follows:

$$\text{Power sensitivity (mhos)} = \frac{P_o \text{ watts}}{(E_{in}, \text{ rms})^2}$$

Electron Tube Applications

The diversified applications of an electron receiving tube have, within the scope of this section, been treated under seven headings. These are: Amplification, Rectification, Detection, Automatic Volume or Gain Control, Oscillation, Frequency Conversion, and Automatic Frequency Control. Although these operations may take place at either radio or audio frequencies and may involve the use of different circuits and different supplemental parts, the general considerations of each kind of operation are basic.

Amplification

The amplifying action of an electron tube was mentioned under Triodes in the section on ELECTRONS, ELECTRODES, and ELECTRON TUBES. This action can be utilized in electronic circuits in a number of ways, depending upon the results desired. Four classes of amplifier service recognized by engineers are covered by definitions standardized by the Institute of Radio Engineers. This classification depends primarily on the fraction of input cycle during which plate current is expected to flow under rated full-load conditions. The classes are class A, class AB, class B, and class C. The term "cutoff bias" used in these definitions is the value of grid bias at which plate current is very small.

Classes of Service

A class A amplifier is an amplifier in which the grid bias and alternating grid voltages are such that plate current in a specific tube flows at all times.

A class AB amplifier is an amplifier in which the grid bias and alternating grid voltages are such that plate current in a specific tube flows for appreciably more than half but less than the entire electrical cycle.

A class B amplifier is an amplifier in which the grid bias is approximately equal to the cutoff value, so that the plate current is approximately zero when no exciting grid voltage is applied,

and so that plate current in a specific tube flows for approximately one-half of each cycle when an alternating grid voltage is applied.

A class C amplifier is an amplifier in which the grid bias is appreciably greater than the cutoff value, so that the plate current in each tube is zero when no alternating grid voltage is applied, and so that plate current flows in a specific tube for appreciably less than one-half of each cycle when an alternating grid voltage is applied.

The suffix 1 may be added to the letter or letters of the class identification to denote that grid current does not flow during any part of the input cycle. The suffix 2 may be used to denote that grid current flows during part of the cycle.

For radio-frequency (rf) amplifiers which operate into a selective tuned circuit, as in radio transmitter applications, or under requirements where distortion is not an important factor, any of the above classes of amplifiers may be used, either with a single tube or a push-pull stage. For audio-frequency (af) amplifiers in which distortion is an important factor, only class A amplifiers permit single-tube operation. In this case, operating conditions are usually chosen so that distortion is kept below the conventional 5 per cent for triodes and the conventional 7 to 10 per cent for tetrodes or pentodes. Distortion can be reduced below these figures by means of special circuit arrangements such as that discussed under inverse feedback. With class A amplifiers, reduced distortion with improved power performance can be obtained by using a push-pull stage for audio service. With class AB and class B amplifiers, a balanced stage using two tubes is required for audio service.

Class A Voltage Amplifiers

As a class A voltage amplifier, an electron tube is used to reproduce grid-voltage variations across an impedance or a resistance in the plate circuit. These

$$\text{or } \frac{\mu_m \times r_p \times R_L}{1000000 \times (r_p + R_L)}$$

where μ is the amplification factor of the tube, R_L is the load resistance in ohms, r_p is the plate resistance in ohms, and μ_m is the transconductance in micromhos.

From the first formula, it can be seen that the gain actually obtainable

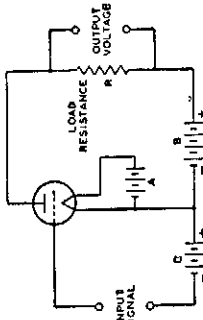

Fig. 14

from the tube is less than the tube amplification factor but that the gain approaches the amplification factor when the load resistance is large compared to the tube plate resistance. Fig. 15 shows graphically how the gain approaches the amplification factor of the tube as the load resistance is increased. From the curve it can be seen that a high value of load resistance should be used to obtain high gain in a voltage amplifier.

In a resistance-coupled amplifier, the load resistance of the tube is approximately equal to the resistance of the plate resistor in parallel with the grid resistor of the following stage. Hence, to obtain a large value of load resistance, it is necessary to use a plate resistor and a grid resistor of large resistance. However, the plate resistor should not be too large because the flow of plate current through the plate resistor produces a voltage drop which reduces the plate voltage applied to the tube. If the plate resistor is too large, this drop will be too

variations are essentially of the same form as the input signal voltage impressed on the grid, but their amplitude is increased. This increase is accomplished by operation of the tube at a suitable grid bias so that the applied grid input voltage produces plate-current variations proportional to the signal swings. Because the voltage variation obtained in the plate circuit is much larger than that required to swing the grid, amplification of the signal is obtained.

Fig. 13 gives a graphical illustration of this method of amplification and

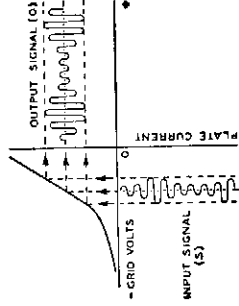

Fig. 13

shows, by means of the grid-voltage vs. plate-current characteristics curve, the effect of an input signal (S) applied to the grid of a tube. The output signal (O) is the resulting amplified plate-current variation.

The plate current flowing through the load resistance (R) of Fig. 14 causes a voltage drop which varies directly with the plate current. The ratio of this voltage variation produced in the load resistance to the input signal voltage is the voltage amplification, or gain, provided by the tube. The voltage amplification due to the tube is expressed by the following convenient formulas:

$$\text{Voltage amplification} = \frac{\mu \times R_L}{R_L + r_p}$$

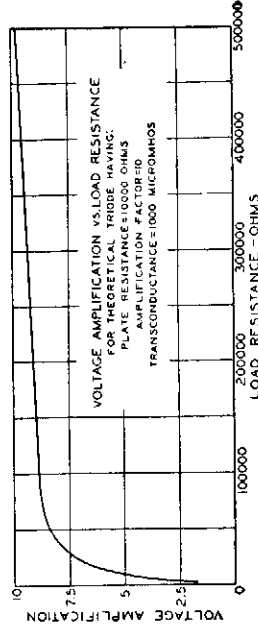

Fig. 15

large, the plate voltage on the tube will be too small, and the voltage output of the tube will be too small. Also, the grid resistor of the following stage should not be too large, the actual maximum value being dependent on the particular tube type. This precaution is necessary because all tubes contain minute amounts of residual gas which cause a minute flow of current through the grid resistor. If the grid resistor is too large, the positive bias developed by the flow of this current through the resistor decreases the normal negative bias and produces an increase in the plate current. This increased current may overheat the tube and cause liberation of more gas which, in turn, will cause further decrease in bias. The action is cumulative and results in a runaway condition which can destroy the tube.

A higher value of grid resistance is permissible when cathode-resistor bias is used than when fixed bias is used. When cathode-resistor bias is used, a loss in bias due to gas or grid-emission effects is almost completely offset by an increase in bias due to the voltage drop across the cathode resistor. Typical values of plate resistor and grid resistor for tube types used in resistance-coupled circuits, and the values of gain obtainable, are shown in the **RESISTANCE-COUPLED AMPLIFIER SECTION**.

The **input impedance** of an electron tube (that is, the impedance between grid and cathode) consists of (1) a reactive component due to the capacitance between grid and cathode, (2) a resistive component resulting from the time of transit of electrons between cathode and grid, and (3) a resistive component developed by the part of the cathode lead inductance which is common to both the input and output circuits. Components (2) and (3) are dependent on the frequency of the incoming signal. The input impedance is very high at audio frequencies when a tube is operated with its grid biased negative. In a class A₁ or AB₁ transformer-coupled audio amplifier, therefore, the loading imposed by the grid on the input transformer is negligible. As a result, the secondary impedance of a class A₁ or class AB₁ input transformer can be made very high because the choice is not limited by the

input impedance of the tube; however, transformer design considerations may limit the choice.

At the higher radio frequencies, the input impedance may become very low even when the grid is negative, due to the finite time of passage of electrons between cathode and grid and to the appreciable lead reactance. This impedance drops very rapidly as the frequency is raised, and increases input-circuit loading. In fact, the input impedance may become low enough at very high radio frequencies to affect appreciably the gain and selectivity of a preceding stage. Tubes such as the "acorn" and "pencil" types and the high-frequency miniatures have been developed to have low input capacitances, low electron-transit time, and low lead inductance so that their input impedance is high even at the ultra-high radio frequencies. **Input admittance** is the reciprocal of input impedance.

A **remote-cutoff amplifier** tube is a modified construction of a pentode or a tetrode type designed to reduce modulation-distortion and cross-modulation in radio-frequency stages. **Cross-modulation** is the effect produced in a radio or television receiver by an interfering station "riding through" on the carrier of the station to which the receiver is tuned. **Modulation-distortion** is a distortion of the modulated carrier and appears as audio-frequency distortion in the output. This effect is produced by a radio-frequency amplifier stage operating on an excessively curved characteristic when the grid bias has been increased to reduce volume. The offending stage for cross-modulation is usually the first radio-frequency amplifier, while for modulation-distortion the cause is usually the last intermediate-frequency stage. The characteristics of remote-cutoff types are such as to enable them to handle both large and small input signals with minimum distortion over a wide range of signal strength.

Fig. 16 illustrates the construction of the grid No.1 (control grid) in a remote-cutoff tube. The remote-cutoff action is due to the structure of the grid which provides a variation in amplification factor with change in grid bias. The grid No.1 is wound with open spacing at

the middle and with close spacing at the ends. When weak signals and low grid bias are applied to the tube, the effect of the non-uniform turn spacing of the grid on cathode emission and tube characteristics is essentially the same as for uniform spacing. As the grid bias is made more negative to handle larger input

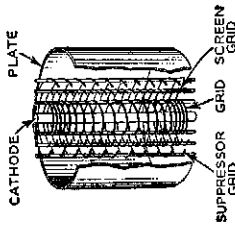

Fig. 16

signals, the electron flow from the sections of the cathode enclosed by the ends of the grid is cut off. The plate current and other tube characteristics are then dependent on the electron flow through the open section of the grid. This action changes the gain of the tube so that large signals may be handled with minimum distortion due to cross-modulation and modulation-distortion.

Fig. 17 shows a typical plate-current vs. grid-voltage curve for a remote-cutoff type compared with the curve for a type having a uniformly spaced grid. It will be noted that while the curves are similar at small grid-bias voltages, the plate current of the remote-cutoff tube drops quite slowly with large values of bias voltage. This slow change makes it

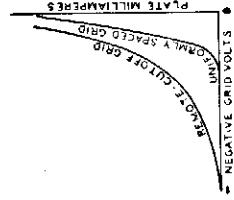

Fig. 17

possible for the tube to handle large signals satisfactorily. Because remote-cutoff types can accommodate large and small signals, they are particularly suitable for use in sets having automatic volume control. Remote-cutoff tubes also are known as **variable- μ types**.

Class A Power Amplifiers

As a class A power amplifier, an electron tube is used in the output stage of a radio or television receiver to supply a relatively large amount of power to the loudspeaker. For this application, large power output is of more importance than high voltage amplification; therefore, gain possibilities are sacrificed in the design of power tubes to obtain power-handling capability.

Triodes, pentodes, and beam power tubes designed for power amplifier service have certain inherent features for each structure. Power tubes of the triode type for class A service are characterized by low power sensitivity, low plate-power efficiency, and low distortion. Power tubes of the pentode type are characterized by high power sensitivity, high plate-power efficiency and, usually, somewhat higher distortion than class A triodes. Beam power tubes have higher

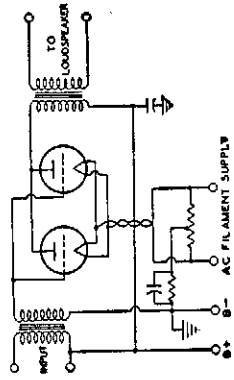

Fig. 18

power sensitivity and efficiency than triode or conventional pentode types.

A class A power amplifier is also used as a driver to supply power to a class AB₂ or a class B stage. It is usually advisable to use a triode, rather than a pentode, in a driver stage because of the lower plate impedance of the triode.

Power tubes connected in either parallel or push-pull may be employed as class A amplifiers to obtain increased output. The parallel connection (Fig. 18) provides twice the output of a single tube with the same value of grid-signal voltage. With this connection, the effective transconductance of the stage is doubled, and the effective plate resistance and the load resistance required are halved as compared with single-tube values.

The push-pull connection (Fig. 19), although it requires twice the grid-signal

voltage, provides increased power and has other important advantages over single-tube operation. Distortion caused by even-order harmonics and hum caused

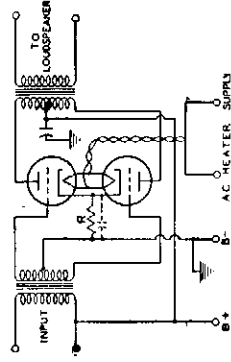

Fig. 19

by plate-voltage-supply fluctuations are either eliminated or decidedly reduced through cancellation. Because distortion for push-pull operation is less than for single-tube operation, appreciably more than twice single-tube output can be obtained with triodes by decreasing the load resistance for the stage to a value approaching the load resistance for a single tube.

For either parallel or push-pull class A operation of two tubes, all electrode currents are doubled while all dc electrode voltages remain the same as for single-tube operation. If a cathode resistor is used, its value should be about one-half that for a single tube. If oscillations occur with either type of connection, they can often be eliminated by the use of a non-inductive resistor of approximately 100 ohms connected in series with each grid at the socket terminal.

Operation of power tubes so that

Power-Output Calculations

Calculation of the power output of a triode used as a class A amplifier with either an output transformer or a choke having low dc resistance can be made without serious error from the plate family of curves by assuming a resistance load. The proper plate current, grid bias, optimum load resistance, and per-cent second-harmonic distortion can also be determined. The calculations are made graphically and are illustrated in Fig. 20 for given conditions. The procedure is as follows:

- 1) Locate the zero-signal bias point P by determining the zero-signal bias E_{c0} from the formula:

$$\text{Zero-signal bias } (E_{c0}) = -(0.68 \times E_b) / \mu$$

where E_b is the chosen value in volts of dc plate voltage at which the tube is to be operated, and μ is the amplification factor of the tube. This quantity is shown as negative to indicate that a negative bias is used.

- 2) Locate the value of zero-signal plate current, I_0 , corresponding to point P.

3) Locate the point 2 I_0 , which is twice the value of I_0 , and corresponds to the value of the maximum-signal plate current I_{max} .

- 4) Locate the point X on the dc bias curve at zero volts, $E_c = 0$, corresponding to the value of I_{max} .

- 5) Draw a straight line XY through X and P.

Line XY is known as the load resistance line. Its slope corresponds to

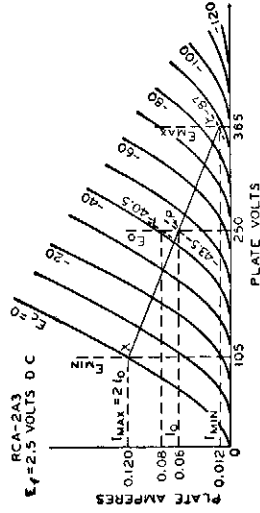

Fig. 20

the grids run positive is inadvisable except under conditions such as those discussed in this section for class AB and class B amplifiers.

It should be noted that in the case of filament types of tubes, the calculations are given on the basis of a dc-operated filament. When the filament is ac-operated, the calculated value of dc bias should be increased by approximately one-half the filament voltage rating of the tube.

The value of zero-signal plate current I_0 should be used to determine the plate dissipation, an important factor influencing tube life. In a class A amplifier under zero-signal conditions, the plate dissipation is equal to the power input, i.e., the product of the dc plate voltage E_0 and the zero-signal dc plate current I_0 . If it is found that the plate dissipation rating of the tube is exceeded with the zero-signal bias E_{c0} calculated above, it will be necessary to increase the bias by a sufficient amount so that the actual plate dissipation does not exceed the rating before proceeding further with the remaining calculations.

For power-output calculations, it is assumed that the peak alternating grid voltage is sufficient (1) to swing the grid from the zero-signal bias value E_{c0} to zero bias ($E_c = 0$) on the positive swing and (2) to swing the grid to a value twice the zero-signal bias value on the negative swing. During the negative swing, the plate voltage and plate current reach values of E_{max} and I_{min} ; during the positive swing, they reach values of E_{min} and I_{max} . Because power is the product of voltage and current, the power output P_0 as shown by a wattmeter is given by

$$P_0 = \frac{(I_{max} - I_{min}) \times (E_{max} - E_{min})}{8}$$

where E is in volts, I is in amperes, and P_0 is in watts.

In the output of power amplifier triodes, some distortion is present. This distortion is due predominantly to second harmonics in single-tube amplifiers. The percentage of second-harmonic distortion may be calculated by the following formula:

$$\% \text{ distortion} = \frac{I_{max} + I_{min} - I_0}{I_{max} - I_{min}} \times 100$$

where I_0 is the zero-signal plate current in amperes. If the distortion is excessive, the load resistance should be increased or, occasionally, decreased slightly and

the calculations repeated.

Example: Determine the load resistance, power output, and distortion factor of a triode having an amplification factor of 4.2, a plate-dissipation rating of 15 watts, and plate characteristics curves as shown in Fig. 20. The tube is to be operated at 250 volts on the plate.

Procedure: For a first approximation, determine the operating point P from the zero-signal bias formula, $E_{c0} = -(0.68 \times 250) / 4.2 = -40.5$ volts. From the curve for this voltage, it is found that the zero-signal plate current I_0 at a plate voltage of 250 volts is 0.08 ampere, and, therefore, the plate-dissipation rating is exceeded ($0.08 \times 250 = 20$ watts). Consequently, it is necessary to reduce the zero-signal plate current to 0.06 ampere at 250 volts. The grid bias is now seen to be -43.5 volts. Note that the curve was taken with a dc filament supply; if the filament is to be operated on an ac supply, the bias must be increased by about one-half the filament voltage, or to -45 volts, and the circuit returns made to the mid-point of the filament circuit.

Point X can now be determined. Point X is at the intersection of the dc bias curve at zero volts with I_{max} , where $I_{max} = 2I_0 = 2 \times 0.06 = 0.12$ ampere. Line XY is drawn through points P and X. E_{max} , E_{min} , and I_{min} are then found from the curves. Substituting these values in the power-output formula, we obtain

$$P_0 = \frac{(0.12 - 0.012) \times (365 - 105)}{8} = 3.52 \text{ watts}$$

The resistance represented by load line XY is

$$\frac{(365 - 105)}{(0.12 - 0.012)} = 2410 \text{ ohms}$$

When the values from the curves are substituted in the distortion formula, we obtain

$$\% \text{ distortion} = \frac{0.12 + 0.012 - 0.06}{0.12 - 0.012} \times 100 = 5.5\%$$

It is customary to select the load resistance so that the distortion does not exceed five per cent. When the method shown is used to determine the slope of the load resistance line, the second-harmonic distortion generally does not exceed five per cent. In the example, however, the distortion is excessive and it is desirable, therefore, to use a slightly

higher load resistance. A load resistance of 2500 ohms will give a distortion of about 4.9 per cent. The power output is reduced only slightly to 3.5 watts.

Operating conditions for triodes in push-pull depend on the type of operation desired. Under class A conditions, distortion, power output, and efficiency are all relatively low. The operating bias can be anywhere between that specified for single-tube operation and that equal to one-half the grid-bias voltage required to produce plate-current cutoff at a plate voltage of $1.4E_0$, where E_0 is the operating plate voltage. Higher bias than this value requires higher grid-signal voltage and results in class AB₁ operation which is discussed later.

The method for calculating maximum power output for triodes in push-pull class A operation is as follows: Erect a vertical line at $0.6 E_0$ (see Fig. 21), intersecting the $E_c=0$ curve at the

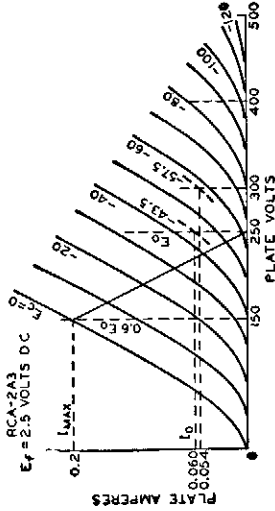

Fig. 21

point I_{max} . Then, I_{max} is determined from the curve for use in the formula

$$P_o = (I_{max} \times E_o) / 5$$

If I_{max} is expressed in amperes and E_0 in volts, power output is in watts.

The method for determining the proper load resistance for triodes in push-pull is as follows: Draw a load line through I_{max} on the zero-bias curve and through the E_0 point on the zero-current axis. Four times the resistance represented by this load line is the plate-to-plate load (R_{pp}) for two triodes in a class A push-pull amplifier. Expressed as a formula,

$$R_{pp} = 4 \times (E_0 - 0.6E_0) / I_{max}$$

where E_0 is expressed in volts, I_{max} in amperes, and R_{pp} in ohms.

Example: Assume that the plate voltage (E_0) is to be 300 volts, and the

plate dissipation rating of the tube is 15 watts. Then, for class A operation, the operating bias can be equal to, but not more than, one-half the grid bias for cutoff with a plate voltage of $1.4 \times 300 = 420$ volts. (Since cutoff bias is approximately -115 volts at a plate voltage of 420 volts, one-half of this value is -57.5 volts bias.) At this bias, the plate current is found from the plate family to be 0.054 ampere and, therefore, the plate dissipation is 0.054×300 or 16.2 watts. Since -57.5 volts is the limit of bias for class A operation of these tubes at a plate voltage of 300 volts, the dissipation cannot be reduced by increasing the bias and it, therefore, becomes necessary to reduce the plate voltage.

If the plate voltage is reduced to 250 volts, the bias will be found to be -43.5 volts. For this value, the plate current is 0.06 ampere, and the plate dissipation is 15 watts. Then, following the

method for calculating power output, erect a vertical line at $0.6E_0 = 150$ volts. The intersection of the line with the curve $E_c = 0$ is I_{max} or 0.2 ampere. When this value is substituted in the power formula, the power output is $(0.2 \times 250) / 5 = 10$ watts. The load resistance is determined from the load formula: Plate-to-plate load (R_{pp}) = $4 \times (250 - 150) / 0.2 = 2000$ ohms.

Power output for a pentode or a beam power tube as a class A amplifier can be calculated in much the same way as for triodes. The calculations can be made graphically from a special plate family of curves, as illustrated in Fig. 22.

From a point A at or just below the knee of the zero-bias curve, draw arbitrarily selected load lines to intersect the zero-plate-current axis. These lines should be on both sides of the operating

point P whose position is determined by the desired operating plate voltage, E_0 , and one-half the maximum-signal plate current. Along any load line, say AA₁, measure the distance AO₁. On the same line, lay off an equal distance, O₁A₁. For optimum operation, the change in bias from A to O₁ should be nearly equal to the change in bias from O₁ to A₁. If this condition can not be met with one line,

simultaneously in the same ratio. The values other than those shown in the published data can be obtained by the use of the nomograph shown in Fig. 23 when all electrode voltages are changed simultaneously in the same ratio. The

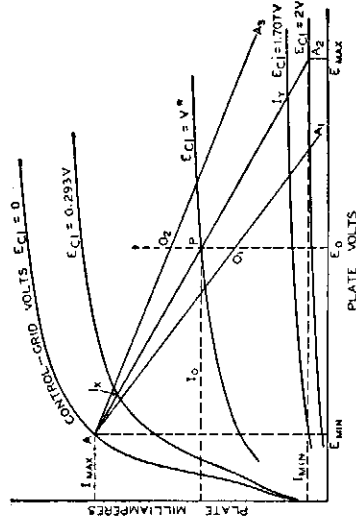

Fig. 22

as is the case for the line first chosen, then another should be chosen. When the most satisfactory line has been selected, its resistance may be determined by the following formula:

$$\text{Load resistance } (R_L) = \frac{E_{max} - E_{min}}{I_{max} - I_{min}}$$

The value of R_L may then be substituted in the following formula for calculating power output.

$$P_o = \frac{[I_{max} - I_{min} + 1.41(I_x - I_y)]^2 R_L}{32}$$

In both of these formulas, I is in amperes, E is in volts, R_L is in ohms, and P_o is in watts. I_x and I_y are the current values on the load line at bias voltages of $E_{c1} = V - 0.707V = 0.293V$ and $E_{c1} = V + 0.707V = 1.707V$, respectively.

Calculations for distortion may be made by means of the following formula. The terms used have already been defined.

$$\% \text{ 2nd-harmonic distortion} = \frac{I_{max} + I_{min} - 2 I_0}{I_{max} - I_{min} + 1.41(I_x - I_y)} \times 100$$

$$\% \text{ 3rd-harmonic distortion} = \frac{I_{max} - I_{min} - 1.41(I_x - I_y)}{I_{max} - I_{min} + 1.41(I_x - I_y)} \times 100$$

nomograph includes conversion factors for current (F_i), power output (F_p), plate resistance or load resistance (F_r), and transconductance (F_{gm}) for voltage ratios between 0.5 and 2.0. These factors are expressed as functions of the ratio between the desired or new voltage for any electrode (E_{des}) and the published or original value of that voltage (E_{pub}). The relations shown are applicable to triodes and multigridd tubes in all classes of service.

To use the nomograph, simply place a straight-edge across the page so that it intersects the scales for E_{des} and E_{pub} at the desired values. The desired conversion factor may then be read directly or estimated at the point where the straight-edge intersects the F_i , F_p , F_r , or F_{gm} scale.

For example, suppose it is desired to operate two 6L6GE's in class A, push-pull, fixed bias, with a plate voltage of 200 volts. The nearest published operating conditions for this class of service are for a plate voltage of 250 volts. The operating conditions for the new plate voltage can be determined as follows:

The voltage conversion factor, F_e ,

is equal to 200/250 or 0.8. The dashed lines on the nomograph of Fig. 23 indicate that for this voltage ratio F_1 is approximately 0.72, F_p is approximately 0.72, F_p is approximately negligible in power tubes. Secondary

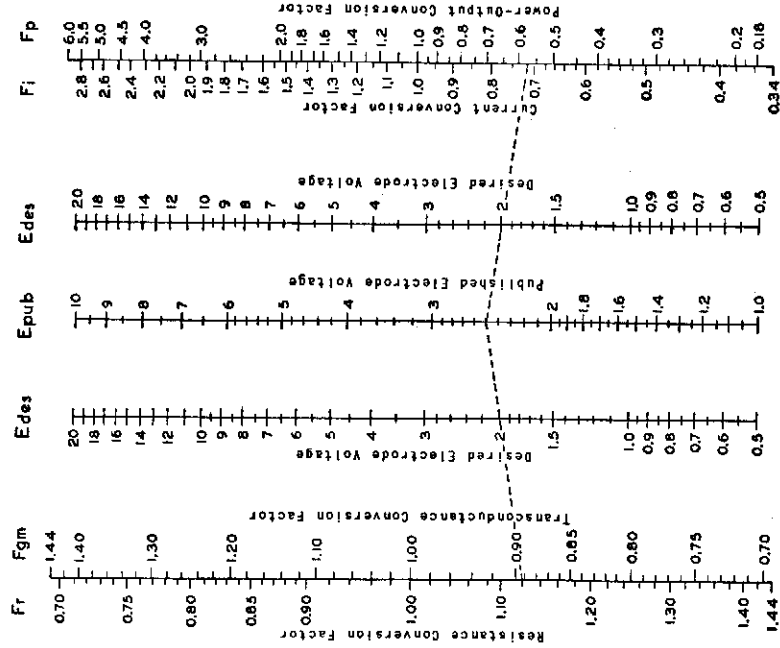

Fig. 23

0.57, F_r is 1.12, and F_{gm} is approximately 0.892. These factors may be applied directly to operating values shown in the tube data, or to values calculated by the methods described previously.

Because this method for conversion of characteristics is necessarily an approximation, the accuracy of the nomograph decreases progressively as the ratio E_{oas}/E_{pmb} departs from unity. In general, results are substantially correct when the value of the ratio E_{oas}/E_{pmb} is between 0.7 and 1.5. Beyond these limits, the accuracy decreases rapidly, and the results obtained must be considered rough approximations.

The nomograph does not take into consideration the effects of contact potential or secondary emission in tubes.

Class AB Power Amplifiers

A class AB power amplifier employs two tubes connected in push-pull with a higher negative grid bias than is

used in a class A stage. With this higher negative bias, the plate and screen-grid voltages can usually be made higher than for class A amplifiers because the increased negative bias holds plate current within the limit of the tube plate-dissipation rating. As a result of these higher voltages, more power output can be obtained from class AB operation.

Class AB amplifiers are subdivided into class AB₁ and class AB₂. In class AB₁, there is no flow of grid current. That is, the peak signal voltage applied to each grid is not greater than the negative grid-bias voltage. The grids therefore are not driven to a positive potential and do not draw current. In class AB₂, the peak signal voltage is greater than the bias so that the grids are driven positive and draw current.

Because of the flow of grid current in a class AB₂ stage there is a loss of

fluctuations in the voltage output of the power supply, with the result that power output is decreased and distortion is increased. To obtain satisfactory regulation it is usually advisable to use a low-drop rectifier, such as the 5Y4GA, with a choke-input filter. In all cases, the resistance of the filter choke and power transformers should be as low as possible.

Class AB₁ Power Amplifiers

In class AB₁ push-pull amplifier service using triodes, the operating conditions may be determined graphically by means of the plate family if E_{c0} , the desired operating plate voltage, is given. In this service, the dynamic load line does not pass through the operating point P as in the case of the single-tube amplifier, but through the point D in Fig. 24. Its position is not affected by the operating grid bias provided the

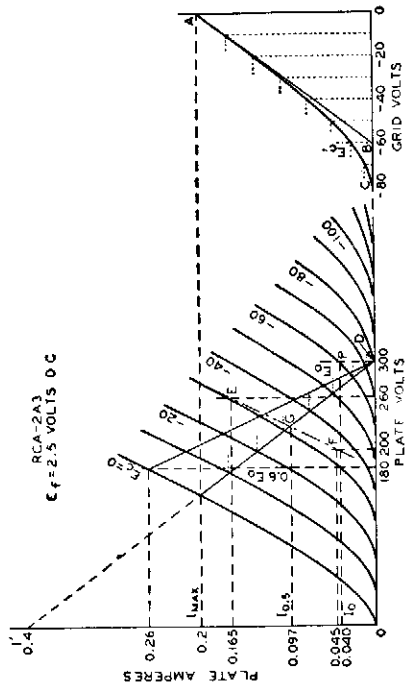

Fig. 24

power in the grid circuit. The sum of this loss and the loss in the input transformer is the total driving power required by the grid circuit. The driver stage should be capable of a power output considerably larger than this required power in order that distortion introduced in the grid circuit be kept low. The input transformer used in a class AB₂ amplifier usually has a step-down turns ratio.

Because of the large fluctuations of plate current in a class AB₂ stage, it is important that the plate power supply should have good regulation. Otherwise the fluctuations in plate current cause

plate-to-plate load resistance remains constant.

Under these conditions, grid bias has no appreciable effect on the power output. Grid bias cannot be neglected, however, since it is used to find the zero-signal plate current and, from it, the zero-signal plate dissipation. Because the grid bias is higher in class AB₁ than in class A service for the same plate voltage, a higher signal voltage may be used without grid current being drawn and, therefore, higher power output is obtained than in class A service.

In general, for any load line through point D, Fig. 24, the plate-to-plate load

resistance in ohms of a push-pull amplifier is $R_{pp} = 4E_0/I$, where I is the plate current value in amperes at which the load line as projected intersects the plate current axis, and E_0 is in volts. This formula is another form of the one given under push-pull class A amplifiers, $R_{pp} = 4(E_0 - 0.6E_0)/I_{max}$, but is more general. Power output = $(I_{max}/\sqrt{2})^2 \times R_{pp}/4$, where I_{max} is the peak plate current at zero grid volts for the load chosen. This formula simplified is $(I_{max})^2 \times R_{pp}/8$. The maximum-signal average plate current is $2I_{max}/\pi$ or $0.636 I_{max}$; the maximum-signal average power input is $0.636 I_{max} \times E_0$.

It is desirable to simplify these formulas for a first approximation. This simplification can be made if it is assumed that the peak plate current, I_{max} , occurs at the point of the zero-bias curve corresponding approximately to $0.6 E_0$, the condition for maximum power output. The simplified formulas are:

$$P_o \text{ (for two tubes)} = (I_{max} \times E_0)/5$$

$$R_{pp} = 1.6E_0/I_{max}$$

where E_0 is in volts, I_{max} is in amperes, R_{pp} is in ohms, and P_o is in watts. It may be found during subsequent calculations that the distortion or the plate dissipation is excessive for this approximation; in that case, a different load resistance must be selected using the first approximation as a guide and the process repeated to obtain satisfactory operating conditions.

Example: Fig. 24 illustrates the application of this method to a pair of 2A3's operated at $E_0 = 300$ volts. Each tube has a plate-dissipation rating of 15 watts. The method is to erect a vertical line at $0.6E_0$, or at 180 volts, which intersects the $E_c = 0$ curve at the point $I_{max} = 0.26$ ampere. Using the simplified formulas, we obtain

$$R_{pp} = (1.6 \times 300)/0.26 = 1845 \text{ ohms}$$

$$P_o = (0.26 \times 300)/5 = 15.6 \text{ watts}$$

At this point, it is well to determine the plate dissipation and to compare it with the maximum rated value. From the average plate current formula (0.636 I_{max}) mentioned previously, the maximum-signal average plate current is 0.166 ampere. The product of this current and the operating plate voltage is 49.8 watts, the average input to the two tubes. From this value, subtract the

power output of 15.6 watts to obtain the total dissipation for both tubes which is 34.2 watts. Half of this value, 17 watts, is in excess of the 15-watt rating of the tube and it is necessary, therefore, to assume another and higher load resistance so that the plate-dissipation rating will not be exceeded.

It will be found that at an operating plate voltage of 300 volts the 2A3's require a plate-to-plate load resistance of 3000 ohms. From the formula for R_{pp} , the value of I is found to be 0.4 ampere. The load line for the 3000-ohm load resistance is then represented by a straight line from the point $I = 0.4$ ampere on the plate-current ordinate to the point $E_0 = 300$ volts on the plate-voltage abscissa. At the intersection of the load line with the zero-bias curve, the peak plate current, I_{max} , can be read at 0.2 ampere. Then $P_o = (I_{max}/\sqrt{2})^2 \times R_{pp}/4 = 15 \text{ watts}$

Proceeding as in the first approximation, we find that the maximum-signal average plate current, $0.636 I_{max}$, is 0.127 ampere, and the maximum-signal average power input is 38.1 watts. This input minus the power output is $38.1 - 15 = 23.1$ watts. This value is the dissipation for two tubes; the value per tube is 11.6 watts, a value well within the rating of this tube type.

The operating bias and the zero-signal plate current may now be found by use of a curve which is derived from the plate family and the load line. Fig. 25 is a curve of instantaneous values of plate current and dc grid-bias voltages taken from Fig. 24. Values of grid bias are read from each of the grid-bias curves of Fig. 24 along the load line and are transferred to Fig. 25 to produce the curved line from A to C. A tangent to this curve, starting at A, is drawn to intersect the grid-voltage abscissa. The point of intersection, B, is the operating grid bias for fixed-bias operation. In the example, the bias is -60 volts. Refer back to the plate family at the operating conditions of plate volts = 300 and grid bias = -60 volts; the zero-signal plate current per tube is seen to be 0.04 ampere.

This procedure locates the operating point for each tube at P. The plate cur-

rent must be doubled, of course, to obtain the zero-signal plate current for both tubes. Under maximum-signal conditions, the signal voltage swings from zero-signal bias voltage to zero bias for each tube on alternate half cycles. Hence, in the example, the peak of signal voltage per tube is 60 volts, or the grid-to-grid value is 120 volts.

As in the case of the push-pull class A amplifier, the second-harmonic distortion in a class AB₁ amplifier using triodes is very small and is largely canceled by virtue of the push-pull connection. Third-harmonic distortion, however, which may be larger than permissible, can be found by means of composite characteristic curves. A complete family of curves can be plotted, but for the present purpose only the one corresponding to a grid bias of one-half the peak grid-voltage swing is needed. In the example, the peak grid voltage per tube is 60 volts, and the half value is 30 volts. The composite curve, since it is nearly a straight line, can be constructed with only two points (see Fig. 24). These two points are obtained from deviations above and below the operating grid and plate voltages.

In order to find the curve for a bias of -30 volts, we have assumed a deviation of 30 volts from the operating grid voltage of -60 volts. Next assume a deviation from the operating plate voltage of, say, 40 volts. Then at 300 - 40 = 260 volts, erect a vertical line to intersect the (-60) - (-30) = -30-volt bias curve and read the plate current at this intersection, which is 0.167 ampere; likewise, at the intersection of a vertical line at 300 + 40 = 340 volts and the (-60) + (-30) = -90-volt bias curve, read the plate current. In this example, the plate current is estimated to be 0.002 ampere. The difference of 0.165 ampere between these two currents determines the point E on the 300 - 40 = 260-volt vertical. Similarly, another point F on the same composite curve is found by assuming the same grid-bias deviation but a larger plate-voltage deviation, say, 100 volts. We now have points at 260 volts and 0.165 ampere (E), and at 200 volts and 0.045 ampere (F). A straight line introduced through these points is the composite curve for a bias of -30 volts, shown as a

long-short dash line in Fig. 24. At the intersection of the composite curve and the load line, G, the instantaneous composite plate current at the point of one-half the peak signal swing is determined. This current value, designated $I_{0.5}$, and the peak plate current, I_{max} , are used in the following formula to find peak value of the third-harmonic component of the plate current.

$$I_{h3} = (2I_{0.5} - I_{max})/3$$

In the example, where $I_{0.5}$ is 0.097 ampere and I_{max} is 0.2 ampere, $I_{h3} = (2 \times 0.097 - 0.2)/3 = (0.194 - 0.2)/3 = -0.006/3 = -0.002$ ampere. (The fact that I_{h3} is negative indicates that the phase relation of the fundamental (first-harmonic) and third-harmonic components of the plate current is such as to result in a slightly peaked wave form. I_{h3} is positive in some cases, indicating a flattening of the wave form.)

The peak value of the fundamental or first-harmonic component of the plate current is found by the following formula:

$$I_{h1} = 2/3 \times (I_{max} + I_{h3})$$

In the example, $I_{h1} = 2/3 \times (0.2 + 0.097) = 0.198$ ampere. Thus, the percentage of third-harmonic distortion is $(I_{h3}/I_{h1}) \times 100 = (0.002/0.198) \times 100 = 1$ per cent approx.

Class AB₂ Power Amplifiers

A class AB₂ amplifier employs two tubes connected in push-pull as in the case of class AB₁ amplifiers. It differs in that it is biased so that plate current flows for somewhat more than half the electrical cycle but less than the full cycle, the peak signal voltage is greater than the dc bias voltage, grid current is drawn, and consequently, power is consumed in the grid circuit. These conditions permit high power output to be obtained without excessive plate dissipation.

The sum of the power used in the grid circuit and the losses in the input transformer is the total driving power required by the grid circuit. The driver stage should be capable of a power output considerably larger than this required power in order that distortion introduced in the grid circuit be kept low. In addition, the internal impedance of the driver stage as reflected into or as

effective in the grid circuit of the power stage should always be as low as possible in order that distortion may be kept low. The input transformer used in a class AB_2 stage usually has a step-down ratio adjusted for this condition.

Load resistance, plate dissipation, power output, and distortion determinations are similar to those for class AB_1 . These quantities are interdependent with peak grid-voltage swing and driving power; a satisfactory set of operating conditions involves a series of approximations. The load resistance and signal swing are limited by the permissible grid current and power, and the distortion. If the load resistance is too high or the signal swing is excessive, the plate-dissipation rating will be exceeded, distortion will be high, and the driving power will be unnecessarily high.

Class B Power Amplifiers

A class B amplifier employs two tubes connected in push-pull, so biased that plate current is almost zero when no signal voltage is applied to the grids. Because of this low value of no-signal plate current, class B amplification has the same advantage as class AB_2 , i.e., large power output can be obtained without excessive plate dissipation. Class B operation differs from class AB_2 in that plate current is cut off for a larger portion of the negative grid swing, and the signal swing is usually larger than in class AB_2 operation.

Because certain triodes used as class B amplifiers are designed to operate very close to zero bias, the grid of each tube is at a positive potential during all or most of the positive half-cycle of its signal swing. In this type of triode operation, considerable grid current is drawn and there is a loss of power in the grid circuit. This condition imposes the same requirement in the driver stage as in a class AB_2 stage; i.e., the driver should be capable of delivering considerably more power output than the power required for the grid circuit of the class B amplifier so that distortion will be low. Similarly, the interstage transformer between the driver and the class B stage usually has a step-down turns ratio. Because of the high dissipations involved in class B operation at zero bias, it is not

feasible to use tetrodes or pentodes in this type of class B operation.

Determination of load resistance, plate dissipation, power output, and distortion is similar to that for a class AB_1 stage.

Power amplifier tubes designed for class A operation can be used in class AB_1 and class B service under suitable operating conditions. There are several tube types designed especially for class B service. The characteristic common to all of these types is a high amplification factor. With a high amplification factor, plate current is small even when the grid bias is zero. These tubes, therefore, can be operated in class B service at a bias of zero volts so that no bias supply is required. A number of class B amplifier tubes consist of two triode units mounted in one tube. The two units can be connected in push-pull so that only one tube is required for a class B stage. An example of a twin triode used in class B service is the 6N7.

High-Fidelity Amplifiers

Several high-fidelity amplifiers are shown in the CIRCUITS SECTION. The performance capabilities of such amplifiers are usually given in terms of frequency response, total harmonic distortion, maximum power output, and noise level.

To provide high-fidelity reproduction of audio program material, an amplifier should have a frequency response which does not vary more than 1 db over the entire audio spectrum. General practice is to design the amplifier so that its frequency response is flat within 1 db from a frequency below the lowest to be reproduced to one well above the upper limit of the audible region.

Harmonic distortion and intermodulation distortion produce changes in program material which may have adverse effects on the quality of the reproduced sound. Harmonic distortion causes a change in the character of an individual tone by the introduction of harmonics which were not originally present in the program material. For high-fidelity reproduction, total harmonic distortion (expressed as a percentage of the output power) should not be greater than about 1 per cent at the de-

sired listening level. Types such as the 6973, 7027A and 7868 are designed to provide extremely low harmonic distortion in suitably designed push-pull amplifier circuits.

Intermodulation distortion is a change in the waveform of an individual tone as a result of interaction with another tone present at the same time in the program material. This type of distortion not only alters the character of the modulated tone, but may also result in the generation of spurious signals at frequencies equal to the sum and difference of the interacting frequencies. Intermodulation distortion should be less than 2 per cent at the desired listening level. In general, any amplifier which has low intermodulation distortion will have very low harmonic distortion.

The maximum power output which a high-fidelity amplifier should deliver depends upon a complex relation of several factors, including the size and acoustic characteristics of the listening area, the desired listening level, and the efficiency of the loudspeaker system. Practically, however, it is possible to determine amplifier requirements in terms of room size and loudspeaker efficiency.

The acoustic power required to reproduce the loudest passages of orchestral music at concert-hall level in the average-size living room is about 0.4 watt. Because high-fidelity loudspeakers of the type generally available for home use have an efficiency of only about 5 per cent, the output stage of the amplifier should therefore be able to deliver a power output of at least 8 watts. Because many wide-range loudspeaker systems, particularly those using frequency-divider networks, have efficiencies of less than 5 per cent, output tubes used with such systems must have correspondingly larger power outputs. The 6973, 7027A, 7189, and 7868 can provide ample output for most systems when used in suitable push-pull circuits.

The noise level of a high-fidelity amplifier determines the range of volume the amplifier is able to reproduce, i.e., the difference (usually expressed in decibels) between the loudest and softest sounds in program material. Because the greatest volume range utilized in electrical program material at the present

time is about 60 db, the noise level of a high-fidelity amplifier should be at least 60 db below the signal level at the desired listening level.

Cathode-Drive Circuits

The preceding text has discussed the use of tubes in the conventional grid-drive type of amplifier—that is, where the cathode is common to both the input and output circuits. Tubes may also be employed as amplifiers in circuit arrangements which utilize the grid or plate as the common terminal. Probably the most important of these amplifiers are the cathode-drive circuit, which is discussed below, and the cathode-follower circuit, which will be discussed later in connection with inverse feedback.

A typical cathode-drive circuit is shown in Fig. 26. The load is placed in

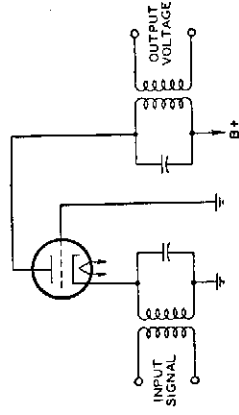

Fig. 26

the plate circuit and the output voltage is taken off between the plate and ground as in the grid-drive method of operation. The grid is grounded, and the input voltage is applied across an appropriate impedance in the cathode circuit. The cathode-drive circuit is particularly useful for vhf and uhf applications, in which it is necessary to obtain the low-noise performance usually associated with a triode, but where a conventional grid-drive circuit would be unstable because of feedback through the grid-to-plate capacitance of the tube. In the cathode-drive circuit, the grounded grid serves as a capacitive shield between plate and cathode and permits stable operation at frequencies higher than those in which conventional circuits can be used.

The input impedance of a cathode-drive circuit is approximately equal to $1/g_m$ when the load resistance is small compared to the r_p of the tube. A certain

amount of power is required, therefore, to drive such a circuit. However, in the type of service in which cathode-drive circuits are normally used, the advantages of the grounded-grid connection usually outweigh this disadvantage.

Inverse Feedback

An inverse-feedback circuit, sometimes called a degenerative circuit, is one in which a portion of the output voltage of a tube is applied to the input of the same or a preceding tube in opposite phase to the signal applied to the tube. Two important advantages of feedback are: (1) reduced distortion from each stage included in the feedback circuit and (2) reduction in the variations in gain due to changes in line voltage, possible differences between tubes of the same type, or variations in the values of circuit constants included in the feedback circuit.

Inverse feedback is used in audio amplifiers to reduce distortion in the output stage where the load impedance on the tube is a loudspeaker. Because the impedance of a loudspeaker is not constant for all audio frequencies, the load impedance on the output tube varies with frequency. When the output tube is a pentode or beam power tube having high plate resistance, this variation in plate load impedance can, if not corrected, produce considerable frequency distortion. Such frequency distortion can be reduced by means of inverse feedback. Inverse-feedback circuits are of the constant-voltage type and the constant-current type.

The application of the constant-voltage type of inverse feedback to a power output stage using a single beam power tube is illustrated by Fig. 27. In this circuit, R_1 , R_2 , and C are connected as a voltage divider across the output of

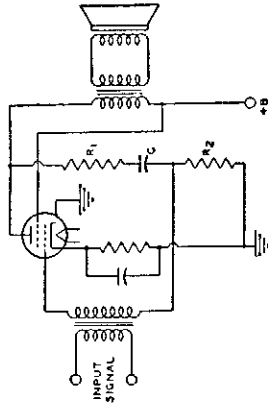

Fig. 27

the tube. The secondary of the grid-input transformer is returned to a point on this voltage divider. Capacitor C blocks the dc plate voltage from the grid. However, a portion of the tube's af output voltage, approximately equal to the output voltage multiplied by the fraction $R_2/(R_1 + R_2)$, is applied to the grid. This voltage lowers the source impedance of the circuit and a decrease in distortion results which is explained in the curves of Fig. 28.

Consider first the amplifier without the use of inverse feedback. Suppose that when a signal voltage e_s is applied to the grid the af plate current i_p has an irregularity in its positive half-cycle. This irregularity represents a departure from the waveform of the input signal and is, therefore, distortion. For this plate-current waveform, the af plate

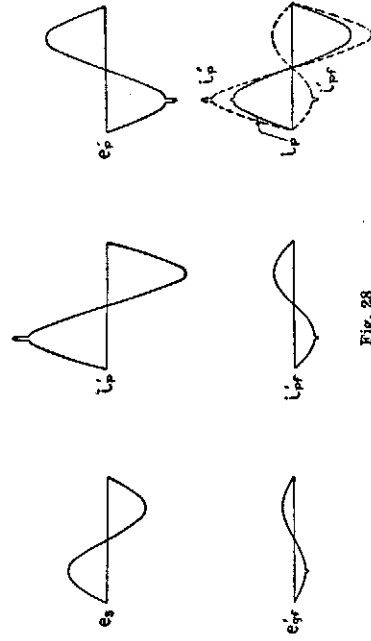

Fig. 28

voltage has a waveform shown by e'_p . The plate-voltage waveform is inverted compared to the plate-current waveform because a plate-current increase produces an increase in the drop across the plate load. The voltage at the plate is the difference between the drop across the load and the supply voltage; thus, when plate current goes up, plate voltage goes down; when plate current goes down, plate voltage goes up.

Now suppose that inverse feedback is applied to the amplifier. The voltage fed back to the grid has the same waveform and phase as the plate voltage, but is smaller in magnitude. Hence, with a plate voltage of waveform shown by e'_p , the feedback voltage appearing on the grid is as shown by e'_{gr} . This voltage applied to the grid produces a component of plate current i'_{pr} . It is evident that the irregularity in the waveform of this component of plate current would act to cancel the original irregularity and thus reduce distortion.

After inverse feedback has been applied, the relations are as shown in the curve for i_p . The dotted curve shown by i'_{pr} is the component of plate current due to the feedback voltage on the grid. The dotted curve shown by i'_p is the component of plate current due to the signal voltage on the grid. The algebraic sum of these two components gives the resultant plate current shown by the solid curve of i_p . Since i'_p is the plate current that would flow without inverse feedback, it can be seen that the application of inverse feedback has reduced the irregularity in the output current. In this manner inverse feedback acts to correct any component of plate current that does not correspond to the input signal voltage, and thus reduces distortion.

From the curve for i_p , it can be seen that, besides reducing distortion, inverse feedback also reduces the amplitude of the output current. Consequently, when inverse feedback is applied to an amplifier there is a decrease in gain or power sensitivity as well as a decrease in distortion. Hence, the application of inverse feedback to an amplifier requires that more driving voltage be applied to obtain full power output, but this output is obtained with less distortion.

Inverse feedback may also be applied to resistance-coupled stages as shown in Fig. 29. The circuit is conventional except that a feedback resistor, R_3 , is connected between the plates of tubes T_1 and T_2 . The output signal voltage of T_1 and a portion of the output signal voltage of T_2 appears across R_3 . Because the distortion generated in the plate circuit of T_2 is applied to its grid out of phase with the input signal, the distortion in the output of T_2 is comparatively low. With sufficient inverse feedback of the constant-voltage type in a power-output stage, it is not necessary to employ a network of resistance and capacitance in the output circuit to reduce response at high audio frequencies. Inverse-feedback circuits can also be applied to push-pull class A and class AB₁ amplifiers.

Constant-current inverse feedback is usually obtained by omitting the bypass capacitor across a cathode resistor.

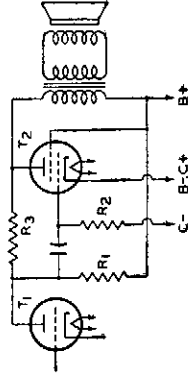

Fig. 29

This method decreases the gain and the distortion but increases the source impedance of the circuit. Consequently, the output voltage rises at the resonant frequency of the loudspeaker and accentuates hangover effects.

Inverse feedback is not generally applied to a triode power amplifier, such as the 2A3, because the variation in speaker impedance with frequency does not produce much distortion in a triode stage having low plate resistance. It is sometimes applied in a pentode stage but is not always convenient. As has been shown, when inverse feedback is used in an amplifier, the driving voltage must be increased in order to give full power output. When inverse feedback is used with a pentode, the total driving voltage required for full power output may be inconveniently large, although still less than that required for a triode. Because a beam power tube gives full

power output on a comparatively small driving voltage, inverse feedback is especially applicable to beam power tubes. By means of inverse feedback, the high efficiency and high power output of beam power tubes can be combined with freedom from the effects of varying speaker impedance.

Cathode-Follower Circuits

Another important application of inverse feedback is in the cathode-follower circuit, an example of which is given in Fig. 30. In this application, the load has been transferred from the plate circuit to the cathode circuit of the tube.

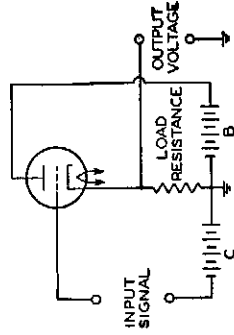

Fig. 30

The input voltage is applied between the grid and ground and the output voltage is obtained between the cathode and ground. The voltage amplification (V.A.) of this circuit is always less than unity and may be expressed by the following convenient formulas.

For a triode:

$$V. A. = \frac{\mu \times R_L}{r_p + [R_L \times (\mu + 1)]}$$

For a pentode:

$$V. A. = \frac{g_m \times R_L}{1 + (g_m \times R_L)}$$

In these formulas, μ is the amplification factor, R_L is the load resistance in ohms, r_p is the plate resistance in ohms, and g_m is the transconductance in mhos.

The use of the cathode follower permits the design of circuits which have high input resistance and high output voltage. The output impedance is quite low and very low distortion may be obtained. Cathode-follower circuits may be used for power amplifiers or as impedance transformers designed either to match a transmission line or to produce a relatively high output voltage at a low impedance level.

In a power amplifier which is transformer coupled to the load, the same

output power can be obtained from the tube as would be obtained in a conventional grid-drive type of amplifier. The output impedance is very low and provides excellent damping to the load, with the result that very low distortion can be obtained. The peak-to-peak signal voltage, however, approaches $1\frac{1}{2}$ times the plate supply voltage if maximum power output is required from the tube. Some problems may be encountered, therefore, in the design of an adequate driver stage for a cathode-follower output system.

When a cathode-follower circuit is used as an impedance transformer, the cathode circuit of the tube. With relatively low values of cathode resistor, the circuit may be designed to supply significant amounts of power and to match the impedance of the device to a transmission line. With somewhat higher values of cathode resistor, the circuit may be used to lower the output impedance sufficiently to permit the transmission of audio signals along a line in which appreciable capacitance is present.

The cathode follower may also be used as an isolation device to provide extremely high input resistance and low input capacitance as might be required in the probe of an oscilloscope or vacuum-tube voltmeter. Such circuits can be designed to provide effective impedance transformation with no significant loss of voltage.

Selection of a suitable tube and its operating conditions for use in a cathode-follower circuit having a specified output impedance (Z_o) can be made, in most practical cases, by the use of the following formula to determine the approximate value of the required tube transconductance.

$$\text{Required } g_m (\mu\text{mhos}) = \frac{1,000,000}{Z_o (\text{ohms})}$$

Once the required transconductance is obtained, a suitable tube and its operating conditions may be determined from the technical data given in the TUBE TYPES SECTION. The tube selected should have a value of transconductance slightly lower than that obtained from the above expression to allow for the shunting effect of the cathode load resistance. The conversion

nomograph given in Fig. 23 may be used for calculation of operating conditions for values of transconductance not included in the tabulated data. After the operating conditions have been determined, the approximate value of the required cathode load resistance may be calculated from the following formulas.

For triode:

$$\text{Cathode } R_L = \frac{Z_o \times r_p}{r_p - [Z_o \times (\mu + 1)]}$$

For pentode:

$$\text{Cathode } R_L = \frac{Z_o}{1 - (g_m \times Z_o)}$$

Resistance and impedance values are in ohms; transconductance values are in mhos.

If the value of the cathode load resistance calculated to give the required output impedance does not give the required operating bias, the basic cathode-follower circuit can be modified in a number of ways. Two of the more common modifications are given in Figs. 31 and 32.

In Fig. 31 the bias is increased by adding a bypassed resistance between the cathode and the unbypassed load resistance and returning the grid to the low end of the load resistance. In Fig. 32 the bias is reduced by adding a bypassed resistance between the cathode and the unbypassed load resistance but, in this case, the grid is returned to the junction of the two cathode resistors so that the bias voltage is only the dc voltage drop across the added resistance. The size of

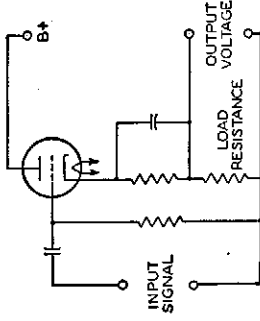

Fig. 31

the bypass capacitor should be large enough so that it has negligible reactance at the lowest frequency to be handled. In both cases the B-supply should be increased to make up for the voltage taken for biasing.

Example: Select a suitable tube

and determine the operating conditions and circuit components for a cathode-follower circuit having an output impedance that will match a 500-ohm transmission line. Procedure: First, determine the approximate transconductance required.

$$\text{Required } g_m = \frac{1,000,000}{500} = 2000 \mu\text{mhos}$$

A survey of the tubes that have a transconductance in this order of magnitude shows that type 12AX7 is among

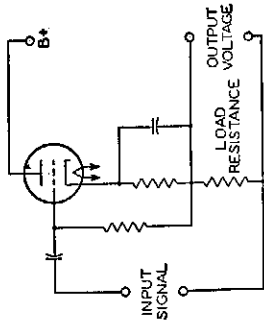

Fig. 32

the tubes to be considered. Referring to the characteristics given in the technical data section for one triode unit of high- μ twin triode 12AX7, we find that for a plate voltage of 250 volts and a bias of -2 volts, the transconductance is 1600 micromhos, the plate resistance is 62500 ohms, the amplification factor is 100, and the plate current is 0.0012 ampere. When these values are used in the expression for determining the cathode load resistance, we obtain

$$\text{Cathode } R_L = \frac{500 \times 62500}{62500 - 500 \times (100 + 1)} = 2600 \text{ ohms}$$

The voltage across this resistor for a plate current of 0.0012 ampere is $2600 \times 0.0012 = 3.12$ volts. Because the required bias voltage is only -2 volts, the circuit arrangement given in Fig. 32 is employed. The bias is furnished by a resistance that will have a voltage drop of 2 volts when it carries a current of 0.0012 ampere. The required bias resistance, therefore, is $2/0.0012 = 1670$ ohms. If 60 cycles per second is the lowest frequency to be passed, 20 microfarads is a suitable value for the bypass capacitor. The B-supply, of course, is increased by the voltage drop across the cathode resistance which, in this exam-

ple, is approximately 5 volts. The B-supply, therefore, is $250 + 5 = 255$ volts. Because it is desirable to eliminate, if possible, the bias resistor and bypass capacitor, it is worthwhile to try other tubes and other operating conditions to obtain a value of cathode load resistance which will also provide the required bias. If the triode section of twin diode—high- μ triode 6AT6 is operated under the conditions given in the technical data section with a plate voltage of 100 volts and a bias of -1 volt, it will have an amplification factor of 70, a plate resistance of 54000 ohms, a transconductance of 1300 micromhos, and a plate current of 0.0003 ampere. Then,

$$\text{Cathode } R_L = \frac{500 \times 54000}{54000 - 600 \times (70 + 1)} = 1460 \text{ ohms}$$

The bias voltage obtained across this resistance is $1460 \times 0.0008 = 1.17$ volts. Since this value is for all practical purposes close enough to the required bias, no additional bias resistance will be required and the grid may be returned directly to ground. There is no need to adjust the B-supply voltage to make up for the drop in the cathode resistor. The voltage amplification (V.A.) for the cathode-follower circuit utilizing the triode section of type 6AT6 is

$$\text{V.A.} = \frac{70 \times 1460}{54000 + 1460 \times (70 + 1)} = 0.65$$

For applications in which the cathode follower is used to isolate two circuits—for example, when it is used between a circuit being tested and the input stage of an oscilloscope or a vacuum-tube voltmeter—voltage output and not impedance matching is the primary consideration. In such applications it is desirable to use a relatively high value of cathode load resistance, such as 50,000 ohms, in order to get the maximum voltage output. In order to obtain proper bias, a circuit such as that of Fig. 32 should be used. With a high value of cathode resistance, the voltage amplification will approximate unity.

Corrective Filters

A corrective filter can be used to improve the frequency characteristic of an output stage using a beam power tube or a pentode. When inverse feedback is not applicable. The filter consists of a resistor and a capacitor connected in

series across the primary of the output transformer. Connected in this way, the filter is in parallel with the plate load impedance reflected from the voice-coil by the output transformer. The magnitude of this reflected impedance increases with increasing frequency in the middle and upper audio range. The impedance of the filter, however, decreases with increasing frequency. It follows that by use of the proper values for the resistance and the capacitance in the filter, the effective load impedance on the output tubes can be made practically constant for all frequencies in the middle and upper audio range. The result is an improvement in the frequency characteristic of the output stage.

The resistance to be used in the filter for a push-pull stage is 1.3 times the recommended plate-to-plate load resistance; or, for a single-tube stage, is 1.3 times the recommended plate load resistance. The capacitance in the filter should have a value such that the voltage gain of the output stage at a frequency of 1000 cycles or higher is equal to the voltage gain at 400 cycles.

A method of determining the proper value of capacitance for the filter is to make two measurements of the output voltage across the primary of the output transformer: first, when a 400-cycle signal is applied to the input, and second, when a 1000-cycle signal of the same voltage as the 400-cycle signal is applied to the input. The correct value of capacitance is the one which gives equal output voltages for the two signal inputs. In practice, this value is usually found to be in the order of 0.05 microfarad.

Volume Compressors and Expanders

Volume compression and expansion are used in FM transmitters and receivers and in recording devices and amplifiers to make more natural the reproduction of music which has a very large volume range. For example, in the music of a symphony orchestra the sound intensity of the soft passages is very much lower than that of the loud passages. When this low volume level is raised above the background noise for transmitting or recording, the peak level of the program material may be raised to an excessively high volume level. It is

often necessary, therefore, to compress the volume range of the program content within the maximum capabilities of the FM transmitter or the recording device. Exceeding a maximum peak volume level for FM modulation corresponds to exceeding the allowed bandwidth for transmission. In some recording devices, excessive peak volume levels may cause overloading and distortion.

Volume compression may be accomplished by either manual or automatic control. The types of compression used include peak limiters, volume limiters, and volume compressors. A peak limiter limits the peak power to some predetermined level. A volume limiter provides gain reduction based on an average signal level above a predetermined level. A volume compressor provides gain reduction for only the sustained loud portions of the sound level. Only volume compressors can be correctly compensated for with volume expanders.

For faithful reproduction of the original sound, the volume expander used in the FM receiver or audio amplifier should have the reverse characteristics of the volume compressor used in the FM transmitter or recording device. In general, the basic requirements for either a volume compressor or expander are shown in the block diagram of Fig. 33.

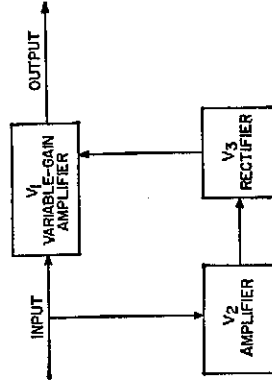

Fig. 33

In a volume compressor, the variable-gain amplifier V_1 has greater gain for a low-amplitude signal than for a high-amplitude signal; therefore, soft passages are amplified more than loud ones. In an expander, the gain is greater for high-amplitude signals than for low-amplitude signals; therefore, loud passages are amplified more than soft ones and the original amplitude ratio is restored.

In the diagram shown in Fig. 33, the

signal to be amplified is applied to V_1 , and a portion of the signal is also applied to V_2 . The amplified output from V_2 is then rectified by V_3 , and applied as a negative (for compressors) or positive (for expanders) bias voltage to V_1 . As this bias voltage varies with variations in signal amplitude, the gain of V_1 also varies to produce the desired compression or expansion of the signal.

Tubes having a large dynamic range provide the best results in volume compressor or expander applications. Examples of such types are the 6B16 and 6BE6. Push-pull operation is generally desired for the variable-gain amplifier to prevent high distortion and other undesirable effects which may occur in volume compressors and expanders.

Phase Inverters

A phase inverter is a circuit used to provide resistance coupling between the output of a signal-tube stage and the input of a push-pull stage. The necessity for a phase inverter arises because the signal-voltage inputs to the grids of a push-pull stage must be 180 degrees out of phase and approximately equal in amplitude with respect to each other. Thus, when the signal voltage input to a push-pull stage swings the grid of one tube in a positive direction, it should swing the grid of the other tube in a negative direction by a similar amount. With transformer coupling between stages, the out-of-phase input voltage to the push-pull stage is supplied by means of the center-tapped secondary. With resistance coupling, the out-of-phase input voltage is obtained by means of the inverter action of a tube.

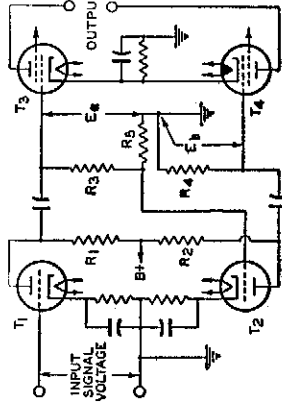

Fig. 34

Fig. 34 shows a push-pull power amplifier, resistance-coupled by means

the frequency is increased, the 100-microfarad capacitor serves as a bypass for the 5-megohm resistor, and the combined impedance of the resistor-capacitor network is lowered. Thus, more

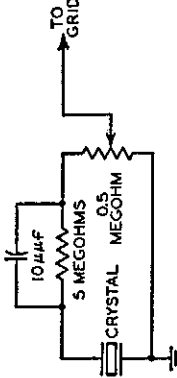

Fig. 35

of the crystal output appears across the 0.5-megohm resistor at high frequencies than at low frequencies, and the frequency response at the grid is reasonably flat over a wide frequency range.

Fig. 36 shows a comparison between the output of the crystal (curve A) and the output of the equalizing network (curve B). The response curve can be "flattened" still more if the attenuation at low frequencies is increased by changing the 0.5-megohm resistor to 0.125 megohm.

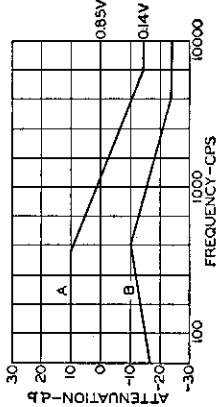

Fig. 36

The tone-control network shown in Fig. 37 has two stages with completely separate bass and treble controls. Fig. 38 shows simplified representations of the bass control of this circuit when the potentiometer is turned to its extreme variations (usually labeled "Boost" and "Cut"). In this network, as in the crystal-equalizing network shown in Fig. 35, the parallel RC combination is the controlling factor. For bass "boost", the capacitor C_2 bypasses resistor R_3 , so that less impedance is placed across the output to grid B at high frequencies than at low frequencies. For bass "cut", the parallel combination is shifted so that C_1 bypasses R_3 , causing more high-frequency than low-frequency output. Essentially, the network is a variable-frequency voltage divider. With proper

of a phase-inverter circuit to a single-stage triode T_1 . Phase inversion in this circuit is provided by triode T_2 . The output voltage of T_1 is applied to the grid of triode T_3 . A portion of the output voltage of T_1 is also applied through the resistors R_3 and R_6 to the grid of T_2 . The output voltage of T_2 is applied to the grid of triode T_4 .

When the output voltage of T_1 swings in the positive direction, the plate current of T_2 increases. This action increases the voltage drop across the plate resistor R_2 and swings the plate of T_2 in the negative direction. Thus, when the output voltage of T_1 swings positive, the output voltage of T_2 swings negative and is, therefore, 180° out of phase with the output voltage of T_1 .

In order to obtain equal voltages at E_a and E_b , $(R_3 + R_6)/R_4$ should equal the voltage gain of T_2 . Under the conditions where a twin-type tube or two tubes having the same characteristics are used at T_1 and T_2 , R_4 should be equal to the sum of R_3 and R_6 . The ratio of $R_3 + R_6$ to R_4 should be the same as the voltage gain ratio of T_2 in order to apply the correct value of signal voltage to T_3 . The value of R_4 is, therefore, equal to R_3 divided by the voltage gain of T_2 ; R_3 is equal to R_4 minus R_6 . Values of R_1 , R_2 , R_3 , plus R_6 , and R_4 may be taken from the chart in the RESISTANCE-COUPLED AMPLIFIER SECTION. In the practical application of this circuit, it is convenient to use a twin-triode tube combining T_1 and T_2 .

Tone Controls

A tone control is a variable filter (or one in which at least one element is adjustable) by means of which the user may vary the frequency response of an amplifier to suit his own taste. In radio receivers and home amplifiers, the tone control usually consists of a resistance-capacitance network in which the resistance is the variable element.

The simplest form of tone control is a fixed tone-compensating or "equalizing" network such as that shown in Fig. 35. This type of network is often used to equalize the low- and high-frequency response of a crystal phonograph pickup. At low frequencies the attenuation of this network is 20.8 db. As

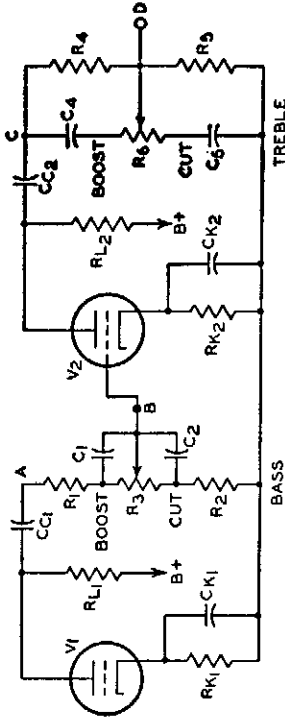

Fig. 37

values for the components, it may be made to respond to changes in the R_4 potentiometer setting for only low frequencies (below 1000 cycles).

In the plate circuit of the power tube, the coupling circuit between the first amplifier tube and the power tube, or the grid circuit of the first tube. In an amplifier using a beam power tube or pentode power amplifier without negative feedback, it is desirable to connect a resistance-capacitance filter across the primary of the output transformer. This filter may be fixed, with a supplementary tone control elsewhere, or it may incorporate negative feedback. If the tone control may be inserted in the feedback network or else should be connected to a part of the feedback loop. The over-all gain of a well designed tone-control network should be approximately unity.

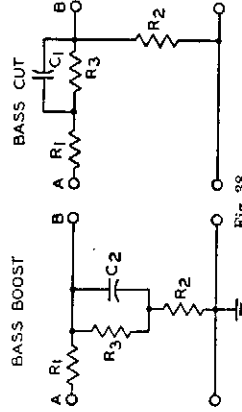

Fig. 38

Fig. 39 shows extreme positions of the treble control. The attenuation of the two circuits is approximately the same at 1000 cycles. The treble "boost" circuit is similar to the crystal-equalizing network shown in Fig. 35. In the treble "cut" circuit, the parallel RC elements serve to attenuate the signal voltage further because the capacitor bypasses the resistance across the output.

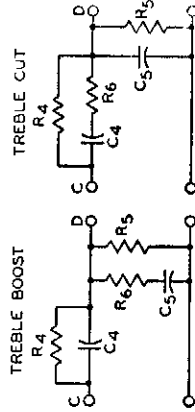

Fig. 39

The effect of the capacitor is negligible at low frequencies; beyond 1000 cycles, the signal voltage is attenuated at a maximum rate of 6 db per octave.

The location of a tone-control network is of considerable importance. In a typical radio receiver, it may be inserted

Phonograph and Tape Preamplifiers

The frequency range and dynamic range which can be recorded on a phonograph record or on magnetic tape depend on several factors, including the composition, mechanical characteristics, and speed of the record or tape, and the electrical and mechanical characteristics of the recording equipment. To achieve wide frequency and dynamic ranges, manufacturers of commercial recordings use equipment which introduces a non-uniform relationship between amplitude and frequency. This relationship is known as a "recording characteristic." To assure proper reproduction of a high-fidelity recording, therefore, some part of the reproducing system must have a frequency-response characteristic which is the inverse of the recording characteristic. Most manufacturers of high-fidelity recordings use the RCA "New Orthophonic" (RIAA) characteristic for discs

and the NARTB characteristic for magnetic tape.

Some typical preamplifier stages are shown in the CIRCUISECTION. The location of the frequency-compensating network or "equalizer" in the reproducing system will depend on the types of recordings which are to be reproduced and on the pickup devices used.

A ceramic high-fidelity phonograph pickup is usually designed to provide proper compensation for the RIAA recording characteristic when the pickup is operated into the load resistance specified by its manufacturer. Because this type of pickup also has relatively high output (0.5 to 1.5 volts), it does not require the use of either an equalizer network or a preamplifier, and can be connected directly to the input of a tone-control amplifier and/or power amplifier.

A magnetic high-fidelity phonograph pickup, on the other hand, usually has an essentially flat frequency-response characteristic and very low output (1 to 10 millivolts). Because a pickup of this type merely reproduces the recording characteristic, it must be followed by an equalizer network, as well as by a preamplifier having sufficient voltage gain to provide the input voltage required by the tone-control amplifier and/or power amplifier. Many designs include both the equalizing and amplifying circuits in a single unit.

A high-fidelity magnetic-tape pickup head, like a magnetic phonograph pickup, reproduces the recording characteristic and has an output of only a few millivolts. This type of pickup device, therefore, must also be followed by an equalizing network and preamplifier, or by a preamplifier which provides "built-in" equalization for the NARTB characteristic.

Limiters

An amplifier may also be used as a limiter. One use of a limiter is in receivers designed for the reception of frequency-modulated signals. The limiter in FM receivers has the function of eliminating amplitude variations from the input to the detector. Because in an FM system amplitude variations are primarily the result of noise disturbances, the use of a limiter prevents such disturbances from being reproduced in the

audio output. The limiter usually follows the last if stage so that it can minimize the effects of disturbances coming in on the rf carrier and those produced locally.

The limiter is essentially an if-voltage amplifier designed for saturated operation. Saturated operation means that an increase in signal voltage above a certain value produces very little increase in plate current. A signal voltage which is never less than sufficient to cause saturation of the limiter, even on weak signals, is supplied to the limiter input by the preceding stages. Any change in amplitude, therefore, such as might be produced by noise voltage fluctuation, is not reproduced in the limiter output. The limiting action, of course, does not interfere with the reproduction of frequency variations.

Plate-current saturation of the limiter may be obtained by the use of grid-No.1-resistor-and-capacitor bias with plate and grid-No.2 voltages which are low compared with customary if-amplifier operating conditions.

As a result of these design features, the limiter is able to maintain its output voltage at a constant amplitude over a wide range of input-signal voltage variations. The output of the limiter is frequency-modulated if voltage, the mean frequency of which is that of the if amplifier. This voltage is impressed on the input of the detector.

The reception of FM signals without serious distortion requires that the response of the receiver be such that satisfactory amplification of the signal is provided over the entire range of frequency deviation from the mean frequency. Since the frequency at any instant depends on the modulation at that instant, it follows that excessive attenuation toward the edges of the band, in the rf or if stages, will cause distortion. In a high-fidelity receiver, therefore, the amplifiers must be capable of amplifying, for the maximum permissible frequency deviation of 75 kilocycles, a band 150 kilocycles wide. Suitable tubes for this purpose are the 6BA6 and 6BJ6.

Television RF Amplifiers

In a radio or television receiver, noise generated in the first amplifier

stage is often the controlling factor in determining the over-all sensitivity of the receiver. The "front end" of a receiver, therefore, is designed with special attention to both gain and noise characteristics.

The input circuit of an amplifier inherently contains some thermal noise contributed by the resistive elements in the input device. When an input signal is amplified, therefore, the thermal noise generated in the input circuit is also amplified. If the ratio of signal power to noise power (signal-to-noise ratio, S/N) is the same in the output circuit as in the input circuit, the amplifier is considered to be "noiseless" and is said to have a noise figure of unity, or zero db.

In practical circuits, however, all amplifier stages generate a certain amount of noise as a result of thermal agitation of electrons in resistors and other components, minute variations in the cathode emission of tubes (shot effect), and minute grid currents in the amplifier tubes. As a result, the ratio of signal power to noise power is inevitably impaired during amplification. A measure of the degree of impairment is called the noise figure (NF) of the amplifier, and is expressed as the ratio of signal power to noise power at the input (S_i/N_i) divided by the ratio of signal power to noise power at the output (S_o/N_o), as follows:

$$NF = \frac{(S_i/N_i)}{(S_o/N_o)}$$

The noise figure in db is equal to ten times the logarithm of this power ratio. For example, an amplifier having a one-db noise figure decreases the signal-to-noise ratio by a factor of 1.26, a 3-db noise figure by a factor of 2, a 10-db noise figure by a factor of 10, and a 20-db noise figure by a factor of 100.

Tuner input circuits of vhf television receivers use either a triode or a pentode in the rf amplifier stage. Such stages are required to amplify signals ranging from 55 to 216 Mc and having a bandwidth of 4.5 Mc, although the tuner is usually aligned for a bandwidth of 6 Mc to assure complete coverage of the band. In the early rf tuners, pentodes rather than triodes were used because the grid-plate capacitance of triodes created stability problems. The use of twin triodes in

direct-coupled cathode-drive circuits makes it possible to obtain stable operation along with the low-noise characteristics of triodes.

Pentodes or tetrodes do not provide the sensitivity of triodes because of the "partition noise" introduced by the screen grid. The direct-coupled cathode-drive circuit provides both the gain and the stability capabilities of the pentode and a low-noise triode input stage. Because the cathode-drive stage provides a low-impedance load to the grounded-cathode stage, its gain is very low and there is no necessity for neutralizing the grid-plate capacitance. An interstage impedance, usually an inductance in series with the plate of the first stage and the cathode of the second stage, is often used at higher frequencies to provide a degree of impedance matching between the units. The cathode-drive portion of the circuit is matched to the input network and provides most of the stage gain. Because the feedback path of the cathode-drive circuit is the plate-cathode capacitance, which in most cases is very small, excellent isolation is provided between the antenna and the local oscillator.

Development of single triodes having low grid-plate capacitance has made possible the design of a neutralized triode rf circuit. The 6BN4 has been used commercially in neutralized triode circuits. Tubes such as the 6GK5 and 6CW4, now in common usage, were specially designed to minimize grid-plate capacitance to permit easier neutralization of a grounded-cathode circuit over the wide frequency band. The bridge-neutralized rf amplifier circuit has become widely used in television tuners. In this arrangement, a portion of the output signal is returned to the grid out of phase with the feedback signal from the grid-plate capacitance. This circuit provides excellent gain and noise performance with stable operation across the band.

Video Amplifiers

The video amplifier stage in a television receiver usually employs a pentode-type tube specially designed to amplify the wide band of frequencies contained in the video signal and, at the same time, to provide high gain per

stage. Pentodes are more useful than triodes in such stages because they have high transconductance (to provide high gain) together with low input and output interelectrode capacitances (to permit the broadband requirements to be satisfied). An approximate "figure of merit" for a particular tube for this application can be determined from the ratio of its transconductance, g_m , to the sum of its input and output capacitances, C_{in} and C_{out} , as follows:

$$\text{Figure of Merit} = \frac{g_m}{C_{in} + C_{out}}$$

Typical values for this figure are in the order of 500×10^4 or greater.

A typical video amplifier stage, such as that shown in Fig. 40, is connected between the second detector of the television receiver and the picture

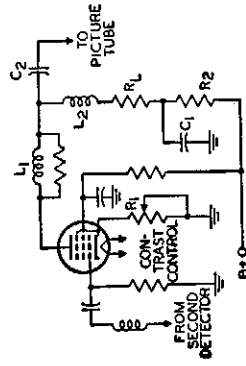

Fig. 40

tube. The contrast control, R_1 , in this circuit controls the gain of the video amplifier tube. The inductance, L_1 , maintains the plate load impedance at a relatively constant value with increasing frequency. The inductance L_2 isolates that only stray capacitance is placed across the load. As a result, a higher-value load resistor is used to provide higher gain without affecting frequency response or phase relations. The decoupling circuit, C_1R_2 , is used to improve the low-frequency response. Tubes used as video amplifiers include types 6CL6 and 12BY7A, or the pentode sections of types 6AW8A and 6AN8.

The luminance amplifier in a color-television receiver is a conventional video amplifier having a bandwidth of approximately 3.5 Mc. In a color receiver, the portion of the output of the second detector which lies within the frequency

band from approximately 2.4 to 4.5 Mc is fed to a bandpass amplifier, as shown in the block diagram in Fig. 41. The color

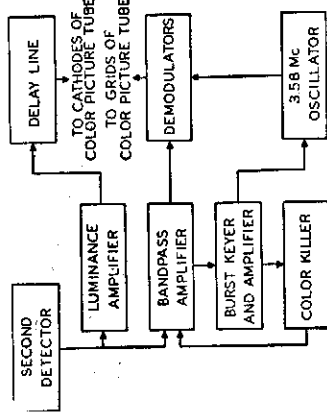

Fig. 41

synchronizing signal, or "burst," contained in this signal may then be fed to a "burst-keyer" tube. At the same time, a delayed horizontal pulse may be applied to the keyer tube. The output of the keyer tube is applied to the burst amplifier tube and the signal is then fed to the 3.58-Mc oscillator and to the "color-killer" stage.

The color killer applies a bias voltage to the bandpass amplifier in the absence of burst so that the color section, or chrominance channel, of the receiver remains inoperative during black-and-white broadcasts. A threshold control varies the bias and controls the burst level at which the killer stage operates.

The output of the 3.58-Mc oscillator and the output of the bandpass amplifier are fed into phase and amplitude demodulator circuits. The output of each demodulator circuit is an electrical representation of a color-difference signal, i.e., an actual color signal minus the black-and-white, or luminance, signal. The two color-difference signals are combined to produce the third color-difference signal; each of the three signals then represents one of the primary colors.

The three color-difference signals are usually applied to the grids of the three electron guns of the color picture tube, in which case the black-and-white signal from the luminance amplifier may be applied simultaneously to the cathodes. The chrominance and luminance signals then combine to produce the color picture. In the absence of trans-

mitted color information, the chrominance channel is cut off by the color killer, as described above, and only the luminance signal is applied to the picture tube, producing a black-and-white picture.

Television Sync Circuits

In addition to picture information, the composite video signal supplied to a television receiver contains information to assure that the picture produced on the receiver is synchronized with the picture being viewed by the camera or pickup tube. The "sync" pulses, which have a greater amplitude than the video signal, trigger the scanning generators of the pickup tube ends each trace.

The sync pulses in the composite video signal may be separated from the video information in the output of the second or video detector by means of the triode circuit shown in Fig. 42. In this circuit, the time constant of the network

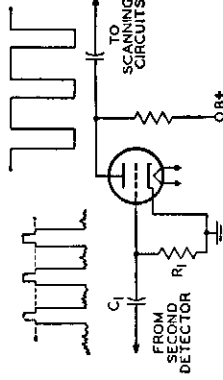

Fig. 42

R_1C_1 is long with respect to the interval between pulses. During each pulse, the grid is driven positive and draws current, thereby charging capacitor C_1 . Consequently, the grid develops a bias which is slightly greater than the cutoff voltage of the tube. Because plate current flows only during the sync-pulse period, only the amplified pulse appears in the output. This sync-separator stage discriminates against the video information. Because the bias developed on the grid is proportional to the strength of the incoming signal, the circuit also has the advantage of being relatively independent of signal fluctuations.

Because the electron beam scans the face of the picture tube at different rates in the vertical and horizontal directions, the receiver incorporates two different scanning generators. The repe-

tion rate of the vertical generator is 60 cycles per second, and the rate of the horizontal generator is approximately 15,750 cycles per second. The composite video signal includes information which enables each generator to derive its correct triggering. One horizontal sync pulse is supplied at the end of each horizontal line scan. At the end of each frame, several pulses of longer duration than the horizontal sync pulses are supplied to actuate the vertical generator. The vertical information is separated from the horizontal information by differentiating and integrating circuits.

In fringe areas, two conditions complicate the process of sync separation. First, the incoming signal available at the antenna is weak and susceptible to the fading and other variations; second, the receiver is operating at or near maximum gain which makes it extremely susceptible to interference from pulse-type noise generated by certain types of electrical equipment, ignition systems, switches, or the like. Some type of noise-immunity provision is almost essential for acceptable performance. Noise may be reduced or eliminated from the sync and agc circuits by gating or by a combination of gating, inversion, and cancellation. An example, of the latter method is shown in Fig. 43. In this circuit the 6GY6, which has two independent control grids, serves the dual function of agc amplifier and noise inverter.

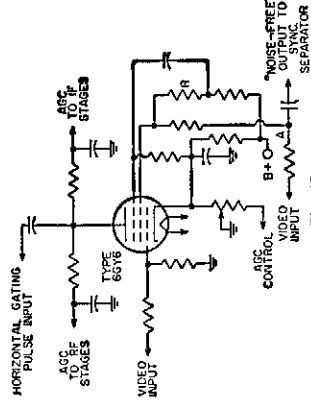

Fig. 43

Because the sync tips of the video signal at grid No.1 of the 6GY6 drive the tube near its cutoff region, any noise signal extending above the tip level will appear inverted across the grid-No.2 load resistor R_1 . This inverted noise signal is re-combined with the video signal and

fed to the sync separator at point "A" Fig. 43 where noise cancellation takes place. This process leaves the sync pulses relatively free of disturbing noise and results in a stable picture. To prevent reduction of receiver gain due to the effect of noise on the age amplifier, a portion of the inverted noise signal is fed to the second control grid, grid No. 3, of the 6GY6 to cut off or gate the AGC amplifier when a noise pulse occurs.

Rectification

The rectifying action of a diode finds important applications in supplying a receiver with dc power from an ac line and in supplying high dc voltage from a high-voltage pulse. A typical arrangement for converting ac to dc includes a rectifier tube, a filter, and a voltage divider. The rectifying action of the tube is explained briefly under *Diodes*, in the **ELECTRONS, ELECTRODES, AND ELECTRON TUBE SECTION**. High-voltage pulse rectification is described later under *Horizontal Output Circuits*.

The function of a filter is to smooth out the ripple of the tube output, as indicated in Fig. 44 and to increase rectifier efficiency. The action of the filter is

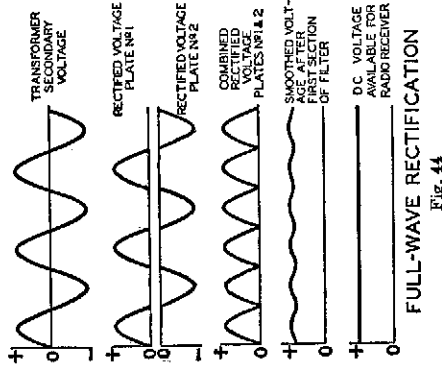

Fig. 44

explained in **ELECTRON TUBE INSTALLATION SECTION** under *Filters*. The voltage divider is used to cut down the output voltage to the values required by the plates and the other electrodes of the tubes in the receiver.

A half-wave rectifier and a full-wave rectifier circuit are shown in Fig. 45. In the half-wave circuit, current flows through the rectifier tube to the filter on every other half-cycle of the ac input voltage when the plate is positive with respect to the cathode. In the full-wave circuit, current flows to the filter on every half-cycle, through plate No. 1 on one half-cycle when plate No. 1 is

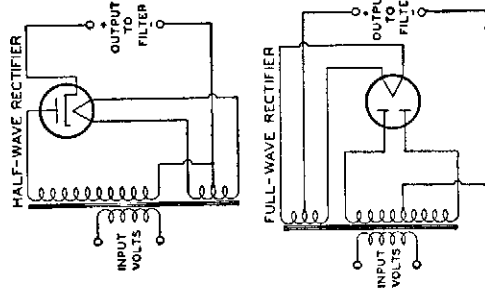

Fig. 45

positive with respect to the cathode, and through plate No. 2 on the next half-cycle when plate No. 2 is positive with respect to the cathode.

Because the current flow to the filter is more uniform in the full-wave circuit than in the half-wave circuit, the output of the full-wave circuit requires less filtering. Rectifier operating information and circuits are given under each rectifier tube type and in the **CIRCUIT SECTION**, respectively.

Parallel operation of rectifier tubes furnishes an output current greater than that obtainable with the use of one tube. For example, when two full-wave rectifier tubes are connected in parallel, the plates of each tube are connected together and each tube acts as a half-wave rectifier. The allowable voltage and load conditions per tube are the same as for full-wave service but the total load-handling capability of the complete rectifier is approximately doubled.

positive half-cycle of the ac input, that is, when the upper side of the ac input line is positive with respect to the lower side, the upper diode passes current and feeds a positive charge into the upper capacitor. As positive charge accumulates on the upper plate of the capacitor, a positive voltage builds up across the capacitor. On the next half-cycle of the ac input, when the upper side of the line is negative with respect to the lower side, the lower diode passes current so that a negative voltage builds up across the lower capacitor.

So long as no current is drawn at the output terminals from the capacitor, each capacitor can charge up to a voltage of magnitude E , the peak value of the ac input. It can be seen from the diagram that with a voltage of $+E$ on one capacitor and $-E$ on the other, the total voltage across the capacitors is $2E$. Thus the voltage doubler supplies a no-load dc output voltage twice as large as the peak ac input voltage. When current is drawn at the output terminals by the load, the output voltage drops below $2E$ by an amount that depends on the magnitude of the load current and the capacitance of the capacitors. The arrangement shown in Fig. 46 is called a full-wave voltage doubler because each rectifier passes current to the load on each half of the ac input cycle.

Two rectifier types especially designed for use as voltage doublers are the 25Z6GT and 117Z6GT. These tubes combine two separate diodes in one tube. As voltage doublers, the tubes are used in "transformerless" receivers. In these receivers, the heaters of all tubes in the set are connected in series with a voltage-dropping resistor across the line. The connections for the heater supply and the voltage-doubling circuit are shown in Fig. 47.

When mercury-vapor rectifier tubes are connected in parallel, a stabilizing resistor of 50 to 100 ohms should be connected in series with each plate lead in order that each tube will carry an equal share of the load. The value of the resistor to be used will depend on the amount of plate current that passes through the rectifier. Low plate current requires a high value; high plate current, a low value. When the plates of mercury-vapor rectifier tubes are connected in parallel, the corresponding filament leads should be similarly connected. Otherwise, the tube drops will be considerably unbalanced and larger stabilizing resistors will be required.

Two or more vacuum rectifier tubes can also be connected in parallel to give correspondingly higher output current and, as a result of paralleling their internal resistances, give somewhat increased voltage output. With vacuum types, stabilizing resistors may or may not be necessary depending on the tube type and the circuit.

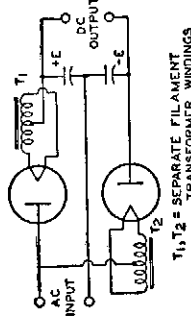

A voltage-doubler circuit of simple form is shown in Fig. 46. The circuit derives its name from the fact that its dc voltage output can be as high as twice the peak value of ac input. Basically, a voltage doubler is a rectifier circuit arranged so that the output voltages of two half-wave rectifiers are in series.

The action of a voltage doubler can be described briefly as follows. On the

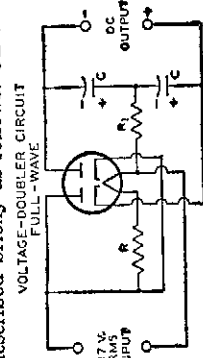

R = HEATERS OF OTHER TUBES IN SERIES WITH VOLTAGE-DROPPING RESISTOR

R1 = PROTECTIVE RESISTOR

With the full-wave voltage-doubler circuit in Fig. 47, it will be noted that the dc load circuit can not be connected to ground or to one side of the ac supply line. This circuit presents certain disadvantages when the heaters of all the



UNMODULATED RF CARRIER



AF MODULATING WAVE



AMPLITUDE-MODULATED RF WAVE

Fig. 48

tubes in the set are connected in series with a resistance across the ac line. Such a circuit arrangement may cause hum because of the high ac potential between the heaters and cathodes of the tubes.

The half-wave voltage-doubler circuit in Fig. 47 overcomes this difficulty by making one side of the ac line common with the negative side of the dc load circuit. In this circuit, one half of the tube is used to charge a capacitor which, on the following half cycle, discharges in series with the line voltage through the other half of the tube. This circuit is called a half-wave voltage doubler because rectified current flows to the load only on alternate halves of the ac input cycle. The voltage regulation of this arrangement is somewhat poorer than that of the full-wave voltage doubler.

Detection

When speech, music, or video information is transmitted from a radio or television station, the station radiates a radio-frequency (rf) wave which is of either of two general types. In one type, the wave is said to be amplitude modulated when its frequency remains constant and the amplitude is varied. In the other type, the wave is said to be frequency modulated when its amplitude remains essentially constant but its frequency is varied.

The function of the receiver is to reproduce the original modulating wave from the modulated rf wave. The receiver stage in which this function is performed is called the demodulator or detector stage.

tor thus temporarily cuts off current through the diode. While the diode current is cut off, the capacitor discharges from (b) to (c) through the diode load resistor R_1 .

When the rf voltage on the anode rises high enough to exceed the potential at which the capacitor holds the cathode, current flows again and the capacitor charges up to the peak value of the second positive half-cycle at (d). In this way, the voltage across the capacitor follows the peak value of the applied rf voltage and reproduces the af modulation.

The curve for voltage across the capacitor, as drawn in Fig. 50, is somewhat jagged. However, this jaggedness, which represents an rf component in the voltage across the capacitor is exaggerated in the drawing. In an actual circuit the rf component of the voltage across the capacitor is negligible. Hence, when the voltage across the capacitor is amplified, the output of the amplifier reproduces the speech or music originating at the transmitting station.

Another way to describe the action of a diode detector is to consider the circuit as a half-wave rectifier. When the rf signal on the plates swings positive, the tube conducts and the rectified current flows through the load resistance R_1 . Because the dc output voltage of a rectifier depends on the voltage of the ac input, the dc voltage across C varies in accordance with the amplitude of the rf carrier and thus reproduces the af signal. Capacitor C should be large enough to smooth out rf or if variations but should not be so large as to affect the audio variations. Two diodes can be connected in a circuit similar to a full-wave rectifier to give full-wave detection. However, in practice, the advantages of this connection generally do not justify the extra circuit complication.

The diode method of detection produces less distortion than other methods because the dynamic characteristics of a diode can be made more linear than those of other detectors. The disadvantages of a diode are that it does not amplify the signal, and that it draws current from the input circuit and therefore reduces the selectivity of the input circuit. However, because the diode

method of detection produces less distortion and because it permits the use of simple avc circuits without the necessity for an additional voltage supply, the diode method of detection is most widely used in broadcast receivers.

A typical diode-detector circuit using a twin-diode triode tube is shown in Fig. 51. Both diodes are connected together. R_1 is the diode load resistor. A portion of the af voltage developed across this resistor is applied to the triode grid through the volume control R_2 . In a typical circuit, resistor R_1 may be tapped

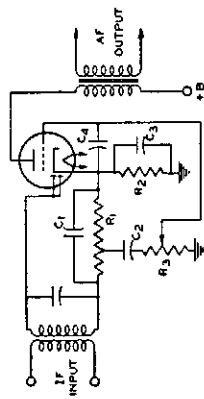

Fig. 51

so that five-sixths of the total af voltage across R_1 is applied to the volume control. This tapped connection reduces the af voltage output of the detector circuit slightly but it reduces audio distortion and improves the rf filtering.

DC bias for the triode section is provided by the cathode-bias resistor R_4 and the audio bypass capacitor C_2 . The function of capacitor C_2 is to block the dc bias of the cathode from the grid. The function of capacitor C_1 is to bypass and rf voltage on the grid to cathode. A twin-diode pentode may also be used in this circuit. With a pentode, the af output should be resistance-coupled rather than transformer-coupled.

Another diode-detector circuit, called a diode-biased circuit, is shown in Fig. 52. In this circuit, the triode grid is

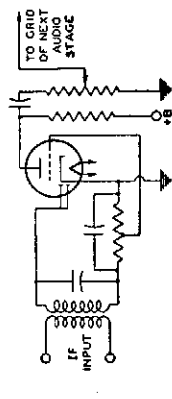

Fig. 52

connected directly to a tap on the diode load resistor. When an rf signal voltage is applied to the diode, the dc voltage at

the effect of amplitude modulation on the waveform of the rf wave is shown in Fig. 48. There are three different basic circuits used for the detection of amplitude-modulated waves: the di-

AM Detection

ode detector, the grid-bias detector, and the grid-resistor detector. These circuits are alike in that they eliminate, either partially or completely, alternate half-cycles of the rf wave. With alternate half-cycles removed, the audio variations of the other half-cycles can be amplified to drive headphones or a loudspeaker.

A diode-detector circuit is shown in Fig. 49. The action of this circuit

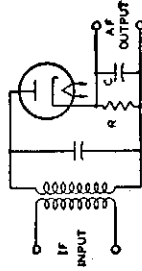

Fig. 49

when a modulated rf wave is applied is illustrated by Fig. 50. The rf voltage applied to the circuit is shown in light line; the output voltage across capacitor C is shown in heavy line.

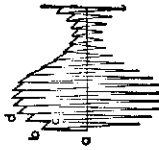

Fig. 50

Between points (a) and (b) on the first positive half-cycle of the applied rf voltage, capacitor C charges up to the peak value of the rf voltage. Then as the applied rf voltage falls away from its peak value, the capacitor holds the cathode at a potential more positive than the voltage applied to the anode. The capaci-

the tap supplies bias to the triode grid. When the rf signal is modulated, the af voltage at the tap is applied to the grid and is amplified by the triode.

The advantage of the circuit shown in Fig. 52 over the self-biased arrangement shown in Fig. 51 is that the diode-biased circuit does not employ a capacitor between the grid and the diode load resistor, and consequently does not produce as much distortion of a signal having a high percentage of modulation.

However, there are restrictions on the use of the diode-biased circuit. Because the bias voltage on the triode depends on the average amplitude of the rf voltage applied to the diode, the average amplitude of the voltage applied to the diode should be constant for all values of signal strength at the antenna. Otherwise there will be different values of bias on the triode grid for different signal strengths and the triode will produce distortion. Because there is no bias applied to the diode-biased triode when no rf voltage is applied to the diode, sufficient resistance should be included in the plate circuit of the triode to limit its zero-bias plate current to a safe value.

These restrictions mean, in practice, that the receiver should have a separate channel automatic-volume-control (avc) system. With such an avc system, the average amplitude of the signal voltage applied to the diode can be held within very close limits for all values of signal strength at the antenna.

The tube used in a diode-biased circuit should be one which operates at a fairly large value of bias voltage. The variations in bias voltage are then a small percentage of the total bias and hence produce small distortion. Tubes taking a fairly large bias voltage are types such as the 6BF6 or 6SR7 having a medium- μ triode. Tube types having a high- μ triode or a pentode should not be used in a diode-biased circuit.

A grid-bias detector circuit is shown in Fig. 53. In this circuit, the grid is biased almost to cutoff, i.e., operated so that the plate current with zero signal is practically zero. The bias voltage can be obtained from a cathode-bias resistor, a C-battery, or a bleeder tap. Because of the high negative bias, only the positive half-cycles of the rf signal are amplified

by the tube. The signal is, therefore, detected in the plate circuit. The advantages of this method of detection are that it amplifies the signal, besides detecting it, and that it does not draw

FM Detection

The effect of frequency modulation on the waveform of the rf wave is shown in Fig. 55. In this type of transmission,

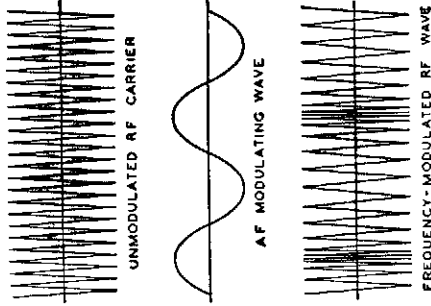

Fig. 55

the frequency of the rf wave deviates from a mean value, at an rf rate depending on the modulation, by an amount that is determined in the transmitter and is proportional to the amplitude of the af modulation signal.

For this type of modulation, a detector is required to discriminate between deviations above and below the mean frequency and to translate those deviations into a voltage whose amplitude varies at audio frequencies. Since the deviations occur at an audio frequency, the process is one of demodulation, and the degree of frequency deviation determines the amplitude of the demodulated (af) voltage.

A simple circuit for converting frequency variations to amplitude variations is a circuit which is tuned so that the mean radio frequency is on one slope of its resonance characteristic, as at A of Fig. 56. With modulation, the frequency swings between B and C, and the voltage developed across the circuit varies at the modulating rate. In order that no distortion will be introduced in this circuit, the frequency swing must be restricted to the portion of the slope which is effectively straight. Since this

portion is very short, the voltage developed is low. Because of these limitations, this circuit is not commonly used but it serves to illustrate the principle.

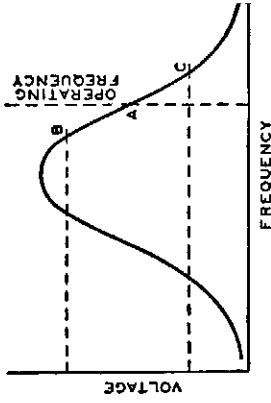

Fig. 56

The faults of the simple circuit are overcome in a push-pull arrangement, sometimes called a discriminator circuit, such as that shown in Fig. 57. Because of the phase relationships between the primary and each half of the secondary of the input transformer (each half with the primary applied to the diodes), the rf voltages applied to the diodes become unequal as the rf signal swings

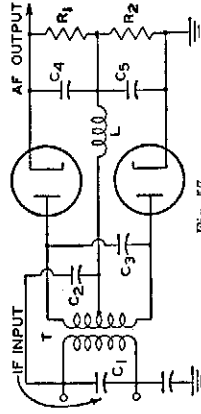

Fig. 57

from the resonant frequency in each direction.

Since the swing occurs at audio frequencies (determined by the af modulation), the voltage developed across the diode load resistors, R₁ and R₂, connected in series, varies at audio frequencies. The output voltage depends on the difference in amplitude of the voltages developed across R₁ and R₂. These voltages are equal and of opposite sign when the rf carrier is not modulated and the output is, therefore, zero. When modulation is applied, the output voltage varies as indicated in Fig. 58.

Because this type of FM detector is sensitive to amplitude variations in the rf carrier, a limiter stage is frequently

used to remove most of the amplitude modulation from the carrier. (See *Limiters under Amplification*.)

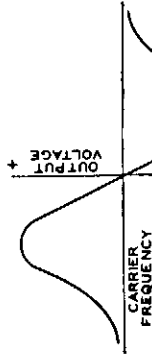

Fig. 58

Another form of detector for frequency-modulated waves is called a **ratio detector**. This FM detector, unlike the previous one which responds to a difference in voltage, responds only to changes in the ratio of the voltage across two diodes and is, therefore, insensitive to changes in the differences in the voltages due to amplitude modulation of the rf carrier.

The basic ratio detector is given in Fig. 59. The plate load for the final if amplifier stage is the parallel resonant

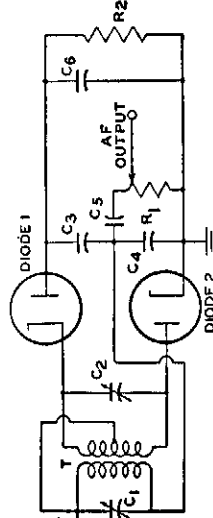

Fig. 59

circuit consisting of C_1 and the primary transformer T. The tuning and coupling of the transformer is practically the same as in the previous circuit and therefore, the rf voltages applied to the diodes depend upon how much the rf signal swings from the resonant frequency in each direction. At this point the similarity ends.

Diode 1, R_2 , and diode 2 complete a series circuit fed by the secondary of the transformer T. The two diodes are connected in series so that they conduct on the same rf half-cycle. The rectified current through R_2 causes a negative voltage to appear at the plate of diode 1. Because C_5 is large, this negative voltage at the plate of diode 1 remains constant

The avc circuit reduces the rf and if gain for a strong signal usually by increasing the negative bias of the rf, if, and frequency-mixer stages when the signal increases. A simple avc circuit is shown in Fig. 60. On each positive half-cycle of the signal voltage, when the diode plate is positive with respect to the cathode, the diode passes current.

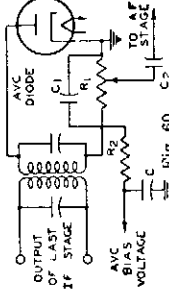

Fig. 60

Because of the flow of diode current through R_1 , there is a voltage drop across R_1 , which makes the left end of R_1 negative with respect to ground. This voltage drop across R_1 is applied, through the filter R_2 and C_2 , as negative bias on the grids of the preceding stages. When the signal strength at the antenna increases, therefore, the signal applied to the avc diode increases, the voltage drop across R_1 increases, the negative bias voltage applied to the rf and if stages increases, and the gain of the rf and if stages is decreased. Thus the increase in signal strength at the antenna does not produce as much increase in the output of the last if stage as it would produce without avc.

When the signal strength at the antenna decreases from a previous steady value, the avc circuit acts, of course, in the reverse direction, applying less negative bias, permitting the rf and if gain to increase, and thus reducing the decrease in the signal output of the last if stage. In this way, when the signal strength at the antenna changes, the avc circuit acts to reduce change in the output of the last if stage, and thus acts to reduce change in loudspeaker volume.

The filter, C_2 and R_2 , prevents the avc voltage from varying at audio frequency. The filter is necessary because the voltage drop across R_1 varies with the modulation of the carrier being received. If avc voltage were taken directly from R_1 without filtering, the audio variations in avc voltage would vary the receiver gain so as to smooth out the modulation of the carrier. To avoid this

effect, the avc voltage is taken from the capacitor C. Because of the resistance R_2 in series with C, the capacitor C can charge and discharge at only a comparatively slow rate. The avc voltage therefore cannot vary at frequencies as high as the audio range but can vary at frequencies high enough to compensate for most fading. Thus the filter permits the avc circuit to smooth out variations in signal due to fading, but prevents the circuit from smoothing out audio modulation.

It will be seen that an avc circuit and a diode-detector circuit are much alike. It is therefore convenient in a receiver to combine the detector and the avc diode in a single stage. Examples of how these functions are combined in receivers are shown in **CIRCUIT SECTION**.

In the circuit shown in Fig. 61, a certain amount of avc negative bias is applied to the preceding stages on a weak signal. Since it may be desirable to maintain the receiver rf and if gain at the maximum possible value for a weak signal, avc circuits are designed in some cases to apply no avc bias until the signal strength exceeds a certain value. These avc circuits are known as **delayed avc** or **davc** circuits.

A davc circuit is shown in Fig. 61. In this circuit, the diode section D_1 of the 6H6 acts as detector and avc diode.

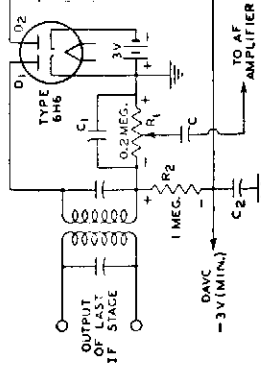

Fig. 61

R_1 is the diode load resistor and R_2 and C_2 are the avc filter. Because the cathode of diode D_1 is returned through a fixed supply of -3 volts to the cathode of D_2 , a dc current flows through R_1 and R_2 in series with D_2 . The voltage drop caused by this current places the avc lead at approximately -3 volts (less the negligible drop through D_2). When the average

amplitude of the rectified signal developed across R_1 does not exceed 3 volts, the avc lead remains at -3 volts. Hence, for signals not strong enough to develop 3 volts across R_1 , the bias applied to the controlled tubes stays constant at a value giving high sensitivity.

However, when the average amplitude of rectified signal voltage across R_1 exceeds 3 volts, the plate of diode D_2 becomes more negative than the cathode of D_2 , and current flow in diode D_2 ceases. The potential of the avc lead is then controlled by the voltage developed across R_1 . Therefore, with further increase in signal strength, the avc circuit applies an increasing avc bias voltage to the controlled stages. In this way, the circuit regulates the receiver gain for strong signals, but permits the gain to stay constant at a maximum value for weak signals.

It can be seen in Fig. 61 that a portion of the -3 volts delay voltage is applied to the plate of the detector diode D_1 , this portion being approximately equal to $R_1/(R_1 + R_2)$ times -3 volts. Hence, with the circuit constants as shown, the detector plate is made negative with respect to its cathode by approximately one-half volt. However, this voltage does not interfere with detection because it is not large enough to prevent current flow in the tube.

Automatic gain control (agc) compensates for fluctuations in rf picture carrier amplitude. The peak carrier level rather than the average carrier level is controlled by the agc voltage because the peaks of the sync pulses are fixed when inserted on a fixed carrier level. The peak carrier level may be determined by measurement of the peaks of the sync pulses at the output of the video detector.

A conventional agc circuit, such as that shown in Fig. 62, consists of a diode

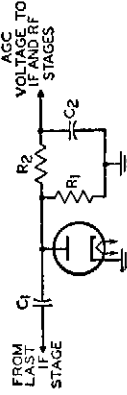

Fig. 62

detector circuit and an RC filter. The time constant of the detector circuit is made large enough to prevent the pic-

ture content from influencing the magnitude of the agc voltage. The output voltage (agc voltage) is equal to the peak value of the incoming signal.

The diode detector receives the incoming signal from the last if stage of the television receiver through the capacitor C_1 . The resistor R_1 provides the load for the diode. The diode conducts only when its plate is driven positive with respect to its cathode. Electrons then flow from the cathode to the plate and thence into capacitor C_1 , where the negative charge is stored. Because of the low impedance offered by the diode during conduction, C_1 charges up to the value of the peak applied voltage.

During the negative excursion of the signal, the diode does not conduct, and C_1 discharges through resistor R_1 . Because of the large time constant of R_1C_1 , however, only a small percentage of the voltage across C_1 is lost during the interval between horizontal sync pulses. During succeeding positive cycles, the incoming signal must overcome the negative charge stored in C_1 before the diode conducts, and plate current flows only at the peak of each positive cycle. The voltage across C_1 , therefore, is determined by the level of the peaks of the positive cycles, or the sync pulses.

The negative voltage developed across resistor R_1 by the sync pulses is filtered by resistor R_2 and capacitor C_2 to remove the 15,750-cycle ripple of the horizontal sync pulse. The dc output is then fed to the if and rf amplifiers as an agc voltage.

This agc system may be expanded to include amplification of the agc signal before detection of the peak level, or amplification of the dc output, or both. A direct-coupled amplifier must be used for amplification of the dc signal. The addition of amplification makes the system more sensitive to changes in carrier level.

A "keyed" agc system such as that shown in Fig. 63 is used to eliminate flutter and to improve noise immunity in weak signal areas. This system provides more rapid action than the conventional agc circuits because the filter circuit can employ lower capacitance and resistance values.

In the keyed agc system, the nega-

tive output of the video detector is fed directly to the grid No.1 of the first video amplifier. The positive output of the video amplifier is, in turn, fed directly to the grid No.1 of the keyed agc amplifier. The video stage increases the gain of the agc system and, in addition,

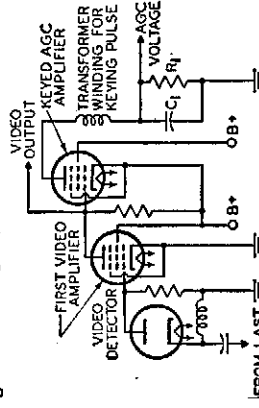

Fig. 63

provides noise clipping. The plate voltage for the agc amplifier is a positive pulse obtained from a small winding on the horizontal output transformer which is in phase with the horizontal sync pulse obtained from the video amplifier. The polarity of this pulse is such that the plate of the agc amplifier tube is positive during the retrace time. The tube is biased so that current flows only when the grid No.1 and the plate are driven positive simultaneously. The amount of potential flow depends on the grid-No.1 are smoothed out in the RC network in the plate circuit (R_1C_1). Because the dc voltage developed across R_1 is negative, it is suitable for application to the grids of the rf and if tubes as an agc voltage.

Tuning Indication With Electron-Ray Tubes

Electron-ray tubes are designed to indicate visually by means of a fluorescent target the effects of a change in controlling voltage. One application of them is as tuning indicators in radio receivers. Types such as the 6U5, 6E5, and the 6AB5/6N5 contain two main parts: (1) a triode which operates as a dc amplifier and (2) an electron-ray indicator which is located in the bulb as shown in Fig. 64. The target is operated at a positive voltage and, therefore, attracts electrons from the cathode. When the electrons strike the target they produce a glow on the fluorescent coating of the target. Under these conditions,

the target appears as a ring of light.

A ray-control electrode is mounted between the cathode and target. When the potential of this electrode is less positive than the target, electrons flowing to the target are repelled by the electrostatic field of the electrode, and do not

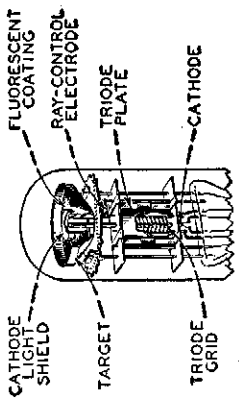

Fig. 64

reach that portion of the target behind the electrode. Because the target does not glow where it is shielded from electrons, the control electrode casts a shadow on the glowing target. The extent of this shadow varies from approximately 100° of the target when the control electrode is much more negative than the target to 0° when the control electrode is at approximately the same potential as the target.

In the application of the electron-ray tube, the potential of the control electrode is determined by the voltage on the grid of the triode section, as can be seen in Fig. 65. The flow of the triode plate current through resistor R produces

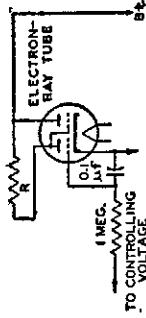
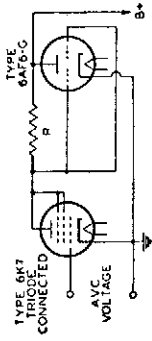

Fig. 65

a voltage drop which determines the potential of the control electrode. When the voltage of the triode grid changes in the positive direction, plate current increases, the potential of the control electrode goes down because of the increased drop across R , and the shadow angle widens. When the potential of the triode grid changes in the negative direction, the shadow angle narrows.

Another type of indicator tube is the 6AF6G. This tube contains only an indicator unit but employs two ray-con-

control electrodes mounted on opposite sides of the cathode and connected to individual base pins. It employs an external dc amplifier. (See Fig. 66.) Thus, two symmetrically opposite shadow angles



R: TYPICAL VALUE IS 0.5 MEGOHM
FIG. 66

may be obtained by connecting the two ray-control electrodes together; or, two unlike patterns may be obtained by individual connection of each ray-control electrode to its respective amplifier.

In radio receivers, avc voltage is applied to the grid of the dc amplifier. Because avc voltage is at maximum when the set is tuned to give maximum response to a station, the shadow angle is at minimum when the receiver is tuned to resonance with the desired station.

The choice between electron-ray tubes depends on the avc characteristic of the receiver. The 6E5 contains a sharp-cutoff triode which closes the shadow angle on a comparatively low value of avc voltage. The 6AB5/6N5 and 6U5 each have a remote-cutoff triode which closes the shadow on a larger value of avc voltage than the 6E5. The 6AF6G may be used in conjunction with dc amplifier tubes having either remote- or sharp-cutoff characteristics.

Oscillation

As an oscillator, an electron tube can be employed to generate a continuously alternating voltage. In present-day radio broadcast receivers, this application is limited practically to superheterodyne receivers for supplying the heterodyning frequency. Several circuits (represented in Figs. 67 and 68) may be utilized, but they all depend on feeding more energy from the plate circuit to the grid circuit than is required to equal the power loss in the grid circuit. Feedback may be produced by electrostatic or electromagnetic coupling between the grid and plate circuits. When sufficient energy is fed back to more than compensate for the loss in the grid circuit, the

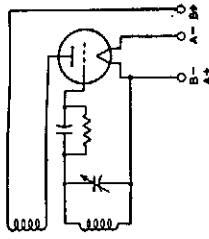

FIG. 67

tube will oscillate. The action consists of regular surges of power between the plate and the grid circuit at a frequency dependent on the circuit constants of inductance and capacitance. By proper choice of these values, the frequency may be adjusted over a very wide range.

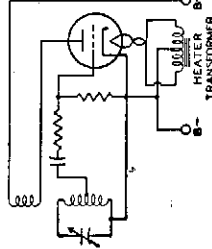

FIG. 68

Multivibrators

Relaxation oscillators, which are widely used in present-day electronic equipment, are used to produce non-sinusoidal waveshapes such as rectangular and sawtooth pulses. Probably the most common relaxation oscillator is the multivibrator, which may be considered as a two-stage resistance-coupled amplifier in which the output of each tube is coupled into the input of the other tube.

Fig. 69 is a basic multivibrator circuit of the free-running type. In this circuit, oscillations are maintained by the

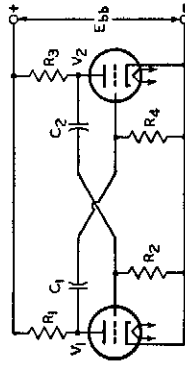

FIG. 69

alternate shifting of conduction from one tube to the other. The cycle usually starts with one tube, V₁, at zero bias, and the other, V₂, at cutoff or beyond. At this point, the capacitor C₁ is charged

a sawtooth voltage to be developed across the capacitor C₃. A portion of this sawtooth is fed back to the grid of the control tube, V₁. The positive sync pulses

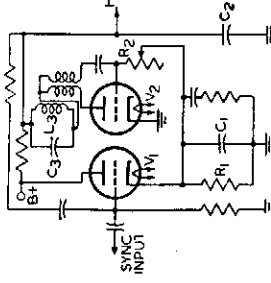

FIG. 70

are also applied to the grid of V₁. The waveforms shown in Fig. 71 illustrate the sawtooth and sync pulses (A and B) and their proper "in-sync" combination (C). The sync pulse occurs partly during the portion of the sawtooth voltage in which the triode V₁ draws current. Any shift in sync pulse as it is superimposed

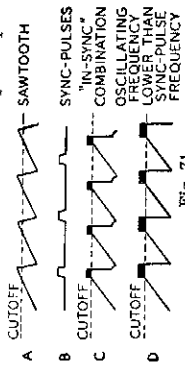

FIG. 71

on the sawtooth, therefore, will affect the amount of conduction of the control tube. A change in control-tube conduction ultimately affects the bias on the oscillator-tube grid by changing the voltage to which the capacitor C₁ in the cathode circuit may charge. An increase in the positive bias increases the frequency of oscillation.

For example, waveform D in Fig. 71 illustrates a condition in which the sawtooth voltage is advanced in phase with respect to the sync-pulses. The widening of the pulse which occurs at the corner of the sawtooth waveform allows the control tube to conduct more current and, consequently, allows the capacitor C₁ to charge to a higher voltage. This increased reference voltage also appears in the grid circuit of V₂ and makes the grid more positive. The increased grid voltage then speeds up the frequency of oscillations until proper synchronization results.

sufficiently to cut off V₂. C₁ then begins to discharge through the resistor R₁, and the voltage on the grid of V₂ rises until V₂ begins to conduct. The voltage on the plate of V₂ then decreases, causing V₁ to conduct less and less. At the same time, the plate voltage of V₁ begins to rise, causing V₂ to conduct still more heavily. Because of the amplification, this cumulative effect builds up extremely fast, and conduction switches from V₁ to V₂ within a few microseconds, depending on the circuit components.

In this circuit, therefore, conduction switches from V₁ to V₂ over the interval during which C₁ discharges from the voltage across R₁ to the cutoff voltage for V₂. The actual transfer of conduction does not occur until cutoff is reached. Conduction switches back to V₁ through a similar process to complete the cycle. The plate waveform is essentially rectangular in shape, and may be adjusted as to symmetry, frequency, and amplitude by proper choice of circuit constants, tubes, and voltages.

Although this type of multivibrator is free-running, it may be triggered by pulses of a given amplitude and frequency to provide a frequency-stabilized output. Multivibrator circuits may also be designed so that they are not free-running, but must be triggered externally to shift conduction from one tube to the other. Depending on the type of circuit, conduction may shift back to the first tube after a given time interval, or the second tube may continue conducting until another trigger signal is applied.

Synchroguide Circuits

The "synchroguide" is a controlled type of oscillator used in television receivers to generate and control the synchronized sawtooth voltage necessary for adequate line- or horizontal-frequency scanning. A simplified synchroguide circuit is shown in Fig. 70. This circuit provides stable, noise-free control of a blocking oscillator which generates a horizontal-frequency signal. It permits comparison of the received sync pulses and the generated sawtooth voltages so that properly locked-in horizontal scanning results.

The triode V₁ in Fig. 70 is a conventional blocking oscillator which enables

The blocking oscillator can be made more immune to changes in frequency and noise if V_2 is brought out of cutoff very sharply. This effect is obtained by sine-wave stabilization. The tuned circuit L_2-C_2 in the plate circuit of Fig. 70 superimposes a shock-excited sine wave on the plate and grid waveforms, as shown in Fig. 72.

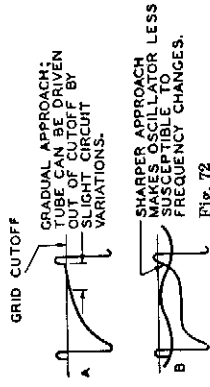

Fig. 72

Deflection Circuits

Vertical Output Circuits

A modified multivibrator in which the vertical output tube is part of the oscillator circuit is used in the vertical deflection stage of many television receivers. This stage supplies the deflection energy required for vertical deflection of the picture-tube beam. A simplified combined vertical-oscillator-output stage is shown in Fig. 73. Waveforms at critical points of the circuit are included

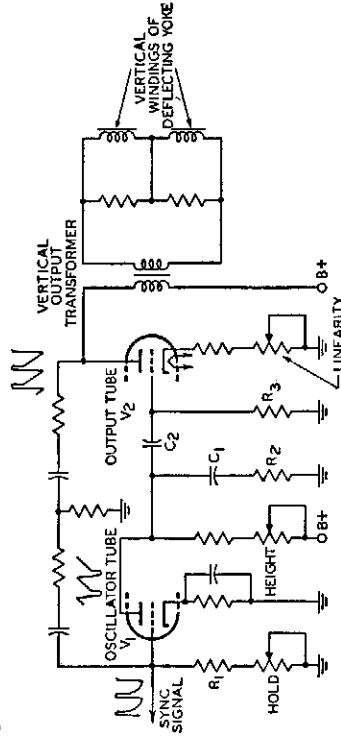

Fig. 73

to illustrate the development of the desired current through the vertical output transformer and deflecting yoke. The current waveform through the deflecting yoke and output transformer should be a sawtooth to provide the desired waveforms of the output tube could also be sawtooth except for the effect of

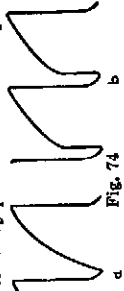

Fig. 74

This vertical deflection stage utilizes twin-triode tubes such as the 6DR7 and 6EM7. The 6EM7 is particularly suitable for this application because it incorporates dissimilar units to provide for the different operating requirements of the oscillator and output sections.

Horizontal Output Circuits

Fig. 75 shows a typical horizontal output-and-deflection circuit used in television receivers. In addition to supplying the deflection energy required for horizontal deflection of the picture-tube beam, this circuit provides the high dc

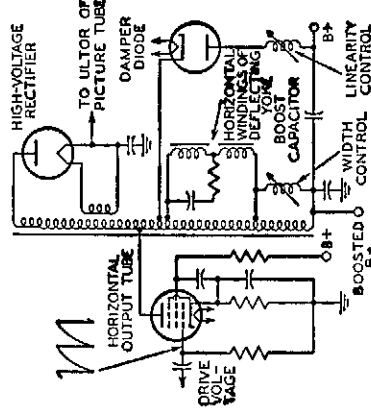

Fig. 75

voltage required for the ultor of the picture tube and the "boosted" B voltage for other portions of the receiver. The horizontal-output tube is usually a beam power tube such as the 6DQ6B, 6CD6-GA, or 6GW6.

In this circuit, a sawtooth voltage from the horizontal-oscillator tube is applied to the grid No.1 of the horizontal-output tube. When this voltage rises above the cutoff point of the output tube, the tube conducts a sawtooth of plate current which is fed through the autotransformer to the horizontal-deflecting yoke. At the end of the horizontal-scanning cycle, which lasts for 63.4 microseconds, the sawtooth voltage on the grid suddenly cuts off the output tube. This sudden change sets up an oscillation of about 50 to 70 Kc in the output circuit, which may be considered as an inductor shunted by the stray capacitance of the circuit. During the first half of this oscillation, a positive voltage appears across the transformer. In the sec-

ond half of the cycle, the voltage swings below the plate supply voltage, and the damper diode conducts, damping out the oscillation. At the same time, the current through the deflecting yoke reverses and reaches its negative peak. As the damper diode current decays exponentially to zero, the output tube begins to conduct again. The yoke current, therefore, is composed of current resulting from damper-diode conduction followed by output-tube conduction.

When the output tube is suddenly cut off, the high-voltage pulse produced by shock excitation of the load circuit is increased by means of an extra winding on the transformer. This high-voltage pulse charges a high-voltage capacitor through the high-voltage rectifier. The output of this circuit is the dc high-voltage supply for the picture tube. The high-voltage rectifier also obtains its filament power through a separate winding on the horizontal-output transformer.

Current flowing through the damper diode charges the "boost" capacitor through the damper portion of the transformer winding. The polarity of the voltage at the low end of the winding is increased above the plate supply voltage, or B+. This higher voltage or "boost" is used for the output-tube plate supply, and may also supply the deflection oscillators and the vertical-output circuit provided the current drain is not excessive.

High-Voltage Regulator Circuit

In color-television receivers, it is very important to regulate the high-voltage supply to the picture tube. A suitable circuit using the 6BK4 for regulation of

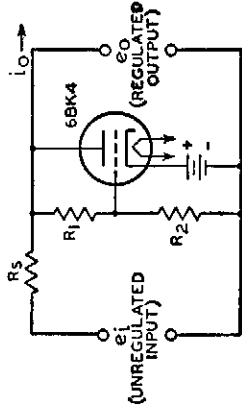

Fig. 76

the output of a high-voltage, high-impedance supply is shown in Fig. 76. In this

circuit, the cathode is held at a fixed positive potential with respect to ground. Because the grid potential is kept slightly less positive by the voltage drop across resistor R_2 , the tube operates in the negative grid region and no grid current is drawn.

When the output voltage, E_o , rises as a result of a decrease in load current, a small fraction of the additional voltage is applied to the grid of the tube by the voltage-divider circuit consisting of R_1 and R_2 . This increased grid voltage causes the tube to draw an increased current from the unregulated supply. The increased current, in turn, causes a voltage drop across the high internal impedance of the unregulated supply, E_s , which tends to counteract the original rise of the voltage. If desired, the grid may be connected to a variable point on the voltage divider to allow some adjustment of the output-voltage level.

The grid voltage for the 6BK4 can also be obtained from a tap on the B-boost voltage supply. The use of this lower voltage (about 375 volts) eliminates the need for costly and troublesome high-voltage resistors. In this arrangement, variations in high voltage also vary the tapped-down B-boost voltage at the regulator grid, and the resulting variations in conduction of the regulator increase or decrease the loading of the high-voltage supply so that the total load remains nearly constant.

Frequency Conversion

Frequency conversion is used in superheterodyne receivers to change the frequency of the rf signal to an intermediate frequency. To perform this change in frequency, a frequency-converting device consisting of an oscillator and a frequency mixer is employed. In such a device, shown diagrammatically in Fig. 77, two voltages of different frequency, the rf signal voltage and the voltage generated by the oscillator, are

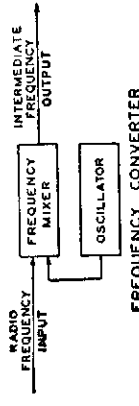

Fig. 77

applied to the input of the frequency mixer. These voltages beat, or heterodyne, within the mixer tube to produce a plate current having, in addition to the frequencies of the input voltages, numerous sum and difference frequencies.

The output circuit of the mixer stage is provided with a tuned circuit which is adjusted to select only one beat frequency, i.e., the frequency equal to the difference between the signal frequency and the oscillator frequency. The selected output frequency is known as the intermediate frequency, or *if*. The output frequency of the mixer tube is kept constant for all values of signal frequency by tuning the oscillator to the proper frequency.

Important advantages gained in a receiver by the conversion of signal frequency to a fixed intermediate frequency are high selectivity with few tuning stages and a high, as well as stable, overall gain for the receiver.

Several methods of frequency conversion for superheterodyne receivers are of interest. These methods are alike in that they employ a frequency-mixer tube in which plate current is varied at a combination frequency of the signal frequency and the oscillator frequency. These variations in plate current produce across the tuned plate load a voltage of the desired intermediate frequency. The methods differ in the types of tubes employed and in the means of supply input voltages to the mixer tube.

A method widely used before the availability of tubes especially designed for frequency-conversion service and currently used in many FM, television, and standard broadcast receivers, employs as mixer tube either a triode, a tetrode, or a pentode, in which oscillator voltage and signal voltage are applied to the same grid. In this method, coupling between the oscillator and mixer circuits is obtained by means of inductance or capacitance.

A second method employs a tube having an oscillator and frequency mixer combined in the same envelope. In one form of such a tube, coupling between the two units is obtained by means of the electron stream within the tube. Because five grids are used, the tube is called a pentagrid converter.

Grids No. 1 and No. 2 and the cathode are connected to an external circuit to act as a triode oscillator. Grid No. 1 is the grid of the oscillator and grid No. 2 is the anode. These and the cathode can be considered as a composite cathode which supplies to the rest of the tube an electron stream that varies at the oscillator frequency.

This varying electron stream is further controlled by the rf signal voltage on grid No. 4. Thus, the variations in plate current are due to the combination of the oscillator and the signal frequencies. The purpose of grids No. 3 and No. 5, which are connected together within the tube, is to accelerate the electron stream and to shield grid No. 4 electrostatically from the other electrodes.

Pentagrid-converter tubes of this design are good frequency-converting devices at medium frequencies. However, their performance is better at the lower frequencies because the output of the oscillator drops off as the frequency is raised and because certain undesirable effects produced by interaction between oscillator and signal sections of the tube increase with frequency.

To minimize these effects, several of the pentagrid-converter tubes are designed so that no electrode functions alone as the oscillator anode. In these tubes, grid No. 1 functions as the oscillator grid, and grid No. 2 is connected within the tube to the screen grid (grid No. 4). The combined two grids, Nos. 2 and 4, shield the signal grid (grid No. 3) and act as the composite anode of the oscillator triode. Grid No. 5 acts as the suppressor grid.

Converter tubes of this type are designed so that the space charge around the cathode is unaffected by electrons from the signal grid. Furthermore, the electrostatic field of the signal grid also has little effect on the space charge. The result is that rf voltage on the signal grid produces little effect on the cathode current. There is, therefore, little detuning of the oscillator by a/c bias because changes in a/c bias produce little change in oscillator transconductance or in the input capacitance of grid No. 1.

Examples of the pentagrid converters discussed in the preceding paragraph are the single-ended types 1R5 and

6BE6. A schematic diagram illustrating the use of the 6BE6 with self-excitation is given in Fig. 78; the 6BE6 may also

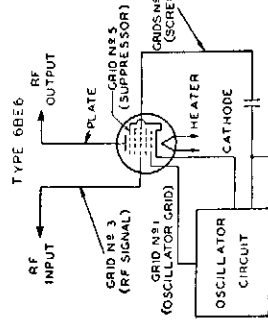

Fig. 78

be used with separate excitation. A complete circuit is shown in the CIRCUIT SECTION.

Another method of frequency conversion utilizes a separate oscillator having its grid connected to the No. 1 grid of a mixer hexode. The cathode, triode grid, and triode plate form the oscillator unit of the tube. The cathode, hexode mixer grid (grid No. 1) hexodescreen grids (grids Nos. 2 and 4), hexode signal grid (grid No. 3), and hexode plate constitute the mixer unit. The internal shields are connected to the shell of the tube and act as a suppressor grid for the hexode unit.

The action of this tube in converting a radio-frequency signal to an intermediate frequency depends on (1) the generation of a local frequency by the triode unit, (2) the transferring of this frequency to the hexode grid No. 1, and (3) the mixing in the hexode unit of this frequency with that of the rf signal applied to the hexode grid No. 3. The tube is not critical to changes in oscillator-plate voltage or signal-grid bias and, therefore, finds important use in all-wave receivers to minimize frequency-shift effects at the higher frequencies.

A further method of frequency conversion employs a tube called a pentagrid mixer. This type has two independent control grids and is used with a separate oscillator tube. RF signal voltage is applied to one of the control grids and oscillator voltage is applied to the other. It follows, therefore, that the variations in plate current are due to the combination of the oscillator and signal frequencies.

The tube contains a heater-cathode, five grids, and a plate. Grids Nos. 1 and 3 are control grids. The rf signal voltage is applied to grid No. 1. This grid has a remote-cutoff characteristic and is suited for control by avc bias voltage. The oscillator voltage is applied to grid No. 3. This grid has a sharp-cutoff characteristic and produces a comparatively large effect on plate current for a small amount of oscillator voltage. Grids Nos. 2 and 4 are connected together within the tube. They accelerate the electron stream and shield grid No. 3 electrostatically from the other electrodes. Grid No. 5, connected within the tube to the cathode, functions similarly to the suppressor grid in a pentode.

In the converter or mixer stage of a television receiver, stable oscillator operation is most readily obtained when separate tubes or tube sections are used for the oscillator and mixer functions. A typical television mixer-oscillator circuit is shown in Fig. 79. In such circuits, the oscillator voltage is applied to the mixer grid by inductive coupling, capacitive coupling, or a combination of the two.

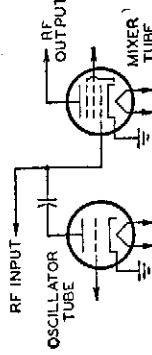

Fig. 79

Tubes containing electrically independent oscillator and mixer units in the same envelope, such as the 6USA and 6X8, are designed especially for this application.

Automatic Frequency Control

An automatic frequency control (afc) circuit provides a means of correcting automatically the intermediate frequency of a superheterodyne receiver when, for any reason, it drifts from the frequency to which the if stages are tuned. This correction is made by adjusting the frequency of the oscillator. Such a circuit will automatically compensate for slight changes in rf carrier or oscillator frequency as well as for inaccurate manual or push-button tuning.

An afc system requires two sections: a frequency detector and a variable re-

actance. The detector section may be essentially the same as the FM detector illustrated in Fig. 57 and discussed under *Detection*. In the afc system, however, the output is a dc control voltage, the magnitude of which is proportional to the amount of frequency shift. This dc control voltage is used to control the grid bias of an electron tube which comprises the variable reactance section (Fig. 80).

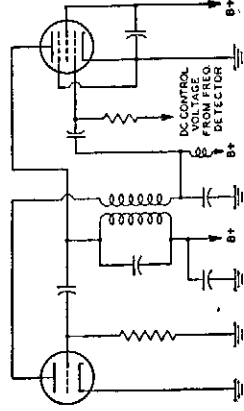

Fig. 80

The plate current of the reactance tube is shunted across the oscillator tank circuit. Because the plate current and plate voltage of the reactance tube are almost 90° out of phase, the control tube affects the tank circuit in the same manner as a reactance. The grid bias of the tube determines the magnitude of the effective reactance and, consequently, a control of this grid bias can be used to control the oscillator frequency.

Automatic frequency control is also used in television receivers to keep the horizontal oscillator in step with the horizontal-scanning frequency (15,750 cps) at the transmitter. A widely used horizontal afc circuit is shown in Fig. 81. This circuit, which is often referred to as a **balanced-phase-detector** or **phase-discriminator** circuit, is usually employed to control the frequency of a multivibrator-type horizontal-oscillator circuit. The 6AL5 detector supplies a dc control voltage to the grid of the horizontal-oscillator tube which counteracts changes in its operating frequency. The magnitude and polarity of the control voltages are determined by phase relationships in the afc circuit at a given moment.

The horizontal sync pulses obtained from the sync-separator circuit are fed through a single-triode phase-inverter or

phase-splitter circuit to the two diode units of the 6AL5. Because of the action of the phase-inverter circuit, the signals

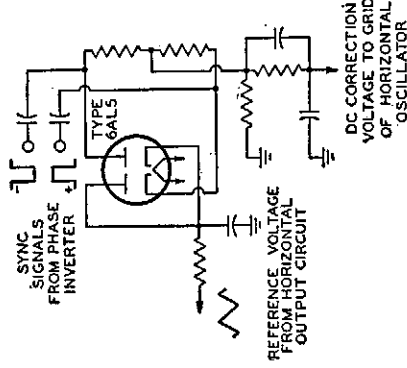

Fig. 81

applied to the two diode units are equal in amplitude but 180 degrees out of phase. A reference sawtooth voltage obtained from the horizontal output circuit is also applied simultaneously to

both units. Any change in the oscillator frequency alters the phase relationship between the reference sawtooth and the incoming horizontal sync pulses, causing one diode unit of the 6AL5 to conduct more heavily than the other, and thus producing a correction signal. The system remains balanced at all times; therefore, because momentary changes in oscillator frequency are instantaneously corrected by the action of the control voltage.

The diode units of the 6AL5 are biased so that conduction takes place only during the tips of the sync pulses. The relative position of the sync pulses on the retrace portion of the sawtooth waveform at any given instant determines which diode unit conducts more heavily, and thereby establishes the magnitude and polarity of the control voltage. The network between the diode units and the grid of the horizontal-oscillator tube is essentially a low-pass filter which prevents the horizontal sync pulses from affecting the horizontal-oscillator performance.

Electron Tube Installation

The installation of electron tubes requires care if high-quality performance is to be obtained from the associated circuits. Installation suggestions and precautions which are generally common to all types of tubes are covered in this section. Careful observance of these suggestions will do much to help the experimenter and electronic technician obtain the full performance capabilities of radio tubes and circuits. Additional pertinent information is given under each tube type and in the **CIRCUIT SECTION**.

Filament and Heater Power Supply

The design of electron tubes allows for some variation in the voltage and current supplied to the filament or heater, but most satisfactory results are obtained from operation at the rated values. When the voltage is low, the temperature of the cathode is below normal, with the result that electron emission is limited. The limited emission may cause unsatisfactory operation and reduced tube life. On the other hand, high cathode voltage may cause rapid evaporation of cathode material and shorten tube life.

To insure proper tube operation, it is important that the filament or heater voltage be checked at the socket terminals by means of a high-resistance voltmeter while the equipment is in operation. In the case of series operation of heaters or filaments, correct adjustment can be checked by means of an ammeter in the heater or filament circuit.

The filament or heater voltage supply may be a direct-current source (a battery or a dc power line) or an alternating-current power line, depending on the type of service and type of tube. Frequently, a resistor (either variable or fixed) is used with a dc supply to permit compensation for battery voltage variations or to adjust the tube voltage at the socket terminals to the correct value. Ordinarily, a step-down transformer is used with an ac supply to pro-

vide the proper filament or heater voltage. Receivers intended for operation on both dc and ac power lines have the heaters connected in series with a suitable resistor and supplied directly from the power line.

DC filament or heater operation should be considered on the basis of the source of power. In the case of the battery supply for the 1.4-volt filament tubes, it is unnecessary to use a voltage-dropping resistor in series with the filament and a single dry-cell; the filaments of these tubes are designed to operate satisfactorily over the range of voltage variations that normally occur during the life of a dry-cell. Likewise, no series resistor is required when the 1.25-volt filament subminiatures are operated from a single 1.5-volt flashlight-type dry-cell, when the 2-volt filament type tubes are operated from a single storage cell, or when the 6.3-volt series are operated from a 6-volt storage battery.

In the case of dry-battery supply for 2-volt filament tubes, a variable resistor in series with the filament and the battery is required to compensate for battery variations. Turning the set on and off by means of the rheostat is advised to prevent over-voltage conditions after an off-period because the voltage of dry-cells rises during off-periods.

In the case of storage-battery supply, air-cell-battery supply, or dc power supply, a non-adjustable resistor of suitable value may be used. It is well to check initial operating conditions, and thus the resistor value, by means of a voltmeter or ammeter.

AC filament or heater operation should be considered on the basis of either a parallel or a series arrangement of filaments and/or heaters. In the case of the parallel arrangement, a step-down transformer is employed. Precautions should be taken to see that the line voltage is the same as that for which the primary of the transformer is designed. The line voltage may be determined by

measurement with an ac voltmeter (0-150 volts).

If the line voltage measures in excess of that for which the transformer is designed, a resistor should be placed in series with the primary to reduce the line voltage to the rated value of the transformer primary. Unless this is done, the excess input voltage will cause proportionally excessive voltage to be applied to the tubes. Any electron tube may be damaged or made inoperative by excessive operating voltages.

If the line voltage is consistently below that for which the primary of the transformer is designed, it may be necessary to install a booster transformer between the outlet and the transformer primary. Before such a transformer is installed, the ac line fluctuations should be very carefully noted. Some radio sets are equipped with a line-voltage switch which permits adjustment of the power transformer primary to the line voltage. When this switch is properly adjusted, the series-resistor or booster-transformer method of controlling line voltage is seldom required.

In the case of the series arrangements of filaments and/or heaters, a voltage-dropping resistor in series with the heaters and the supply line is usually required. This resistance should be of such value that, for normal line voltage, tubes will operate at their rated heater or filament current. The method for calculating the resistor value is given below.

When the filaments of battery-type tubes are connected in series, the total filament current is the sum of the current due to the filament supply and the plate and grid-No.2 currents (cathode current) returning to B(-) through the tube filaments. Consequently, in a series filament string it is necessary to add shunt resistors across each filament section to bypass this cathode current in order to maintain the filament voltage at its rated value.

The filament or heater resistor required when filaments and/or heaters are operated in parallel can be determined easily by a simple formula derived from Ohm's law.

Required resistance (ohms) =

$$\frac{\text{supply volts} - \text{rated volts of tube type}}{\text{total rated filament current (amperes)}}$$

Electron Tube Installation

Thus, if a receiver using two IT4's, one IR5, one IU5, and one 3V4 is to be operated from a storage battery, the series resistor is equal to 2 volts (the voltage from a single storage cell) minus 1.4 volts (voltage rating for these tubes) divided by 0.3 ampere (the sum of 4×0.05 ampere + 1×0.1 ampere), i.e., approximately 2 ohms. Since this resistor should be variable to allow adjustment for battery depreciation, it is advisable to obtain the next larger commercial size, although any value between 2 and 3 ohms will be quite satisfactory.

Where much power is dissipated in the resistor, the wattage rating should be sufficiently large to prevent overheating. The power dissipation in watts is equal to the voltage drop in the resistor multiplied by the total filament current in amperes. Thus, for the example above, $0.6 \times 0.3 = 0.18$ watt. In this case, the value is so small that any commercial rheostat with suitable resistance will be adequate.

For the case where the heaters and/or filaments of several tubes are operated in series, the resistor value is calculated by the following formula, also derived from Ohm's law.

Required resistance (ohms) =

$$\frac{\text{supply volts} - \text{total rated volts of tubes}}{\text{rated amperes of tubes}}$$

Thus, if a receiver having one 6BE6, one 6BA6, one 6AT6, one 25L6GT, and one 25Z6GT is to be operated from a 117-volt power line, the series resistor is equal to 117 volts (the supply voltage) minus 68.9 volts (the sum of 3×6.3 volts + 2×25 volts) divided by 0.3 ampere (current rating of these tubes), i.e., approximately 160 ohms. The wattage dissipation in the resistor will be 117 volts minus 68.9 volts times 0.3 ampere, or approximately 14.4 watts. A resistor having a wattage rating in excess of this value should be chosen.

When the series-heater connection is used in ac/dc receivers, it is usually advisable to arrange the heaters in the circuit so that the tubes most sensitive to hum disturbances are at or near the ground potential of the circuit. This arrangement reduces the amount of ac

voltage between the heaters and cathodes of these tubes and minimizes the hum output of the receiver. The order of heater connection, by tube function, from chassis to the rectifier-cathode side of the ac line is shown in Fig. 82.

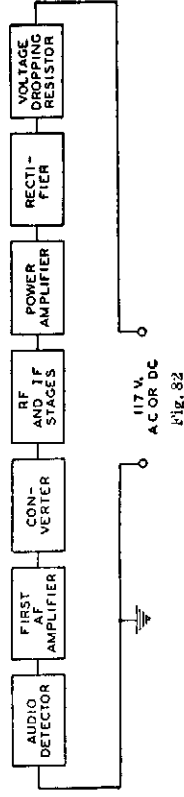

Heater-to-Cathode Connection

When heater-type tubes are operated from ac, their cathodes may be returned (through resistors, capacitors, or other components) to the mid-tap on the heater supply winding, to the mid-tap of a small resistor (about 50 ohms) connected across the winding, or to one end of the heater supply winding, depending on circuit requirements. In all circuits, it is important to keep the heater-cathode voltage within the maximum ratings specified for the tube.

Heater-type tubes may produce hum as a result of conduction between heater and cathode or between heater and control grid, or by modulation of the electron stream by the alternating magnetic field surrounding the heater. When a large resistor is used between heater and cathode (as in series-connected heater strings), or when one side of the heater is grounded, even a minute pulsating leakage current between heater and cathode can develop a small voltage across the cathode-circuit impedance and cause objectionable hum. The use of a large cathode bypass capacitor is recommended to minimize this source of hum.

Much lower hum levels can be achieved when heaters are connected in parallel systems in which the center-tap of the heater supply is grounded or, preferably, connected to a positive bias source of 15 to 80 volts dc to reduce the flow of alternating current. The heater leads of the tubes should be twisted and kept away from high-impedance circuits. The balanced ac supply provides almost complete cancellation of the alternating-current components.

The balanced arrangement described above also minimizes heater-grid hum. High grid-circuit impedances should be avoided, if possible. High heater voltages should also be avoided because heater-cathode hum rises sharply when

the heater voltage is increased above the published value.

Certain tube types are designed especially to minimize hum in high-quality, high-fidelity audio equipment. Examples are the 5879, 7025, and 7199.

Plate Voltage Supply

The plate voltage for electron tubes is obtained from batteries, rectifiers, direct-current power lines, and small local generators. The maximum plate-voltage value for any tube type should not be exceeded if most satisfactory performance is to be obtained. Plate voltage should not be applied to a tube unless the corresponding recommended voltage is also supplied to the grid.

It is recommended that the primary circuit of the power transformer be fused to protect the rectifier tube(s), the power transformer, filter capacitor, and chokes in case a rectifier tube fails.

Grid Voltage Supply

The recommended grid voltages for different operating conditions have been carefully determined to give the most satisfactory performance. Grid voltage may be obtained from a fixed source such as a separate C-battery or a tap on the voltage divider of the high-voltage dc supply, from the voltage drop across a resistor in the cathode circuit, or from the voltage drop across a resistor in the grid circuit. The first method is called "fixed bias"; the second is called "cathode bias" or "self bias"; the third is called "grid-resistor bias" and is sometimes incorrectly referred to in receiving-tube practice as "zero-bias operation."

In any case, the object is to make

the grid negative with respect to the cathode by the specified voltage. When a C-battery is used, the negative terminal is connected to the grid return and the positive terminal is connected to the negative filament socket terminal, or to the cathode terminal if the tube is of the heater-cathode type. If the filament is supplied with alternating current, this connection is usually made to the center-tap of a low resistance (20-50 ohms) shunted across the filament terminals. This method reduces hum disturbances caused by the ac supply. If bias voltages are obtained from the voltage divider of a high-voltage dc supply, the grid return is connected to a more negative tap than the cathode.

The cathode-biasing method utilizes the voltage drop produced by the cathode current flowing through a resistor connected between the cathode and the negative terminal of the B-supply. (See Fig. 83.) The cathode current is, of course, equal to the plate current in the case of a triode, or to the sum of the plate and grid-No.2 currents in the case of a tetrode, pentode, or beam power tube. Because the voltage drop along the resistance is increasingly negative with respect to the cathode, the required negative grid-bias voltage can be

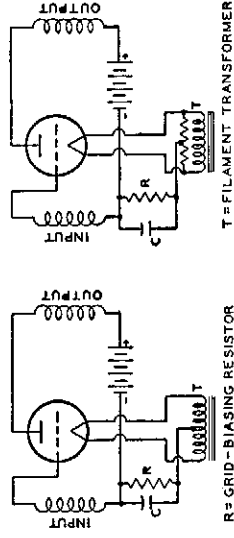

obtained by connecting the grid return to the negative end of the resistance.

The value of the resistance for cathode-biasing a single tube can be determined from the following formula:

$$\text{Resistance (ohms)} = \frac{\text{desired grid-bias voltage} \times 1,000}{\text{rated cathode current in milliamperes}}$$

Thus, the resistance required to produce 9 volts bias for a triode which operates at 3 milliamperes plate current is 9 X

1000/3 = 3000 ohms. If the cathode current of more than one tube passes through the resistor, or if the tube or tubes employ more than three electrodes, the total current determines the size of the resistor.

Bypassing of the cathode-bias resistor depends on circuit-design requirements. In rf circuits the cathode resistor usually is bypassed. In af circuits the use of an unbypassed resistor will reduce distortion by introducing degeneration into the circuit. However, the use of an unbypassed resistor decreases gain and power sensitivity. When bypassing is used, it is important that the bypass capacitor be sufficiently large to have negligible reactance at the lowest frequency to be amplified.

In the case of power-output tubes having high transconductance such as the beam power tubes, it may be necessary to shunt the bias resistor with a small mica capacitor (approximately 0.001 μf) in order to prevent oscillations. The usual af bypass may or may not be used, depending on whether or not degeneration is desired. In tubes having high values of transconductance, such as the 6BA6, 6CB6, and 6AC7, input capacitance and input conductance change appreciably with plate current.

When such a tube having a separate suppressor-grid connection is used as an rf amplifier, these changes may be minimized by leaving a certain portion of the cathode-bias resistor unbypassed. In order to minimize feedback when this method is used, the external grid-No.1-to-plate (wiring) capacitances should be kept to a minimum, the grid No.2 should be bypassed to ac ground, and the grid No.3 should be connected to ac ground. The use of a cathode resistor to

grid is made more positive, as shown in Fig. 87. The value of grid voltage at which the grid-current curve intercepts the horizontal axis is determined by several different physical processes, including an electrothermal effect due to the differences in temperature and in material composition of the grid and the cathode, and by the positive grid current. For values of grid potentials which

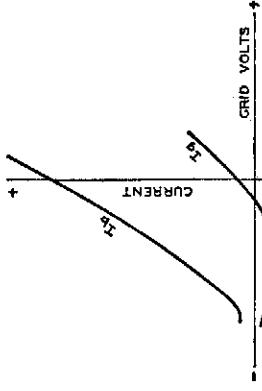

Fig. 87

are larger than this intercept, the direction of the grid current is positive (i.e., from the grid to the cathode). At smaller values of grid potential, the direction of the grid current is negative (i.e., from the cathode to the grid).

Positive grid current consists of electrons emitted from the cathode which are intercepted by the control grid. Negative grid current, which becomes appreciable only when the grid potential is more negative than the value of the intercept, is a result of the emission of electrons from the heated control grid to the cathode, the effect of gas molecules in the tube, and the influence of leakage currents between the grid and cathode and the grid and the plate.

The value of grid potential at the intercept of the grid-current curve on the horizontal axis (often mistakenly called contact potential) may be as high as 1½ volts. If the operating bias of the tube is less than this intercept, it is found that two effects are present. Direct current flows in the grid circuit, and the dynamic input resistance of the tube may be relatively low. It is generally desirable to supply the tube with a value of bias sufficiently high so that the operating point of the tube is not near the value of this intercept. If the value of

the operating bias is near the value of the intercept care should be taken to avoid undesirable effects in the grid circuit due to grid current or low input resistance.

Screen-Grid Voltage Supply

The positive voltage for the screen grid (grid No.2) of screen-grid tubes may be obtained from a tap on a voltage divider, from a potentiometer, or from a series resistor connected to a high-voltage source, depending on the particular tube type and its application. The screen-grid voltage for tetrodes should be obtained from a voltage divider or a potentiometer rather than through a series resistor from a high-voltage source because of the characteristic screen-grid current variations of tetrodes. Fig. 88 shows a tetrode with its screen-grid voltage obtained from a potentiometer.

When pentodes or beam power tubes are operated under conditions where a large shift of plate and screen-grid currents does not take place with the application of the signal, the screen-grid voltage may be obtained through a series resistor from a high-voltage source. This method of supply is possible because of

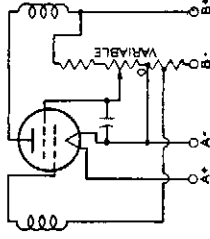

Fig. 88

the high uniformity of the screen-grid current characteristic in pentodes and beam power tubes. Because the screen-grid voltage rises with increase in bias and resulting decrease in screen-grid current, the cutoff characteristic of a pentode is extended by this method of supply.

This method is sometimes used to increase the range of signals which can be handled by a pentode. When used in resistance-coupled amplifier circuits employing pentodes in combination with the cathode-biasing method, it minimizes the need for circuit adjustments. Fig. 89 shows a pentode with its screen-

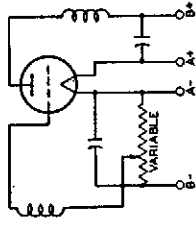

Fig. 54

matic volume control. The latter circuit is shown in Fig. 60.

In all cases it is important that the control be arranged so that at no time will the bias be less than the recommended minimum grid-bias voltage for the particular tubes used. This requirement can be met by providing a fixed stop on the potentiometer, by connecting

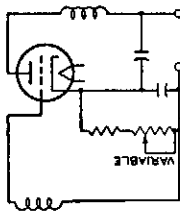

Fig. 85

a fixed resistance in series with the variable resistance, or by connecting a fixed cathode resistance in series with the variable resistance used for regulation. Where receiver gain is controlled by grid-bias variation, it is advisable to have the control voltages extend over a wide range in order to minimize cross-modulation and modulation-distortion.

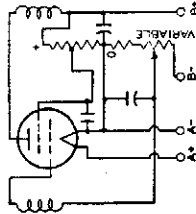

Fig. 86

A remote-cutoff type of tube should, therefore, be used in the controlled stages.

In most tubes employing a unipotential cathode, a positive grid current begins to flow when the grid is slightly negative and increases rapidly as the

obtain bias voltage is not recommended for amplifiers in which there is appreciable shift of electrode currents with the application of a signal. In such amplifiers, a separate fixed supply is recommended.

The grid-resistor biasing method is also a self-bias method because it utilizes the voltage drop across the grid resistor produced by small amounts of grid current flowing in the grid-cathode circuit. This current is due to (1) an electromotive potential difference between the materials comprising the grid and cathode and (2) grid rectification when the grid is driven positive. A large value of resistance is required in order to limit this current to a very small value and to avoid undesirable loading effects on the preceding stage.

Examples of this method of bias are given in circuits 22-1 and 22-4 in the CIRCUIT SECTION. In both of these circuits, the audio amplifier type 1U5 or 12AV6 has a 10-megohm resistor between the grid and the negative filament or cathode to furnish the required bias which is usually less than 1 volt. This method of biasing is used principally in the early voltage amplifier stages (usually employing high-mu triodes) of audio amplifier circuits, where the tube dissipation will not be excessive under zero-signal conditions.

A grid resistor is also used in many oscillator circuits for obtaining the required bias. In these circuits, the grid voltage is relatively constant and its magnitude is usually in the order of 5 volts or more. Consequently, the bias voltage is obtained only through grid rectification. A relatively low value of resistor, 0.1 megohm or less, is used. Oscillator circuits employing this method of bias are given in circuits 22-1 and 22-4 in the CIRCUIT SECTION.

Grid-bias variation for the rf and amplifier stages is a convenient and frequently used method for controlling receiver volume. The variable voltage supplied to the grid may be obtained: (1) from a variable cathode resistor as shown in Figs. 84 and 85; (2) from a bleeder circuit by means of a potentiometer as shown in Fig. 86; or (3) from a bleeder circuit in which the bleeder current is varied by a tube used for auto-

grid voltage supplied through a series resistor.

When power pentodes and beam power tubes are operated under conditions such that there is a large change in plate and screen-grid currents with the application of signal, the series-resistor method of obtaining screen-grid voltage should not be used. A change in screen-grid current appears as a change

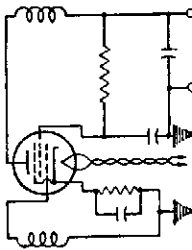

Fig. 89

in the voltage drop across the series resistor in the screen-grid circuit; the result is a change in the power output and an increase in distortion. The screen-grid voltage should be obtained from a point in the plate-voltage-supply filter system having the correct voltage, or from a separate source.

It is important to note that the plate voltage of tetrodes, pentodes, and beam power tubes should be applied before or simultaneously with the screen-grid voltage. Otherwise, with voltage on the screen grid only, the screen-grid current may rise high enough to cause excessive screen-grid dissipation.

Screen-grid voltage variation for the rf amplifier stages has sometimes been used for volume control in older-type receivers. Reduced screen-grid voltage lowers the transconductance of the tube and results in reduced gain per stage. The voltage variation is obtained by means of a potentiometer shunted across the screen-grid voltage supply. (See Fig. 88.) When the screen-grid voltage is varied, it must never exceed the rating of the tube. This requirement can be met by providing a fixed stop on the potentiometer.

Shielding

In high-frequency stages having high gain, the output circuit of each stage must be shielded from the input circuit of that stage. Each high-frequency

stage also must be shielded from the other high-frequency stages. Unless shielding is employed, undesired feedback may occur and may produce many harmful effects on receiver performance.

To prevent this feedback, it is a desirable practice to shield separately each unit of the high-frequency stages. For instance, in a superheterodyne receiver, each if and rf coil may be mounted in a separate shield can. Baffle plates may be mounted on the ganged tuning capacitor to shield each section of the oscillator coil may be especially well shielded by being mounted under the chassis.

The shielding precautions required in a receiver depend on the design of the receiver and the layout of the parts. In all receivers having high-gain high-frequency stages, it is necessary to shield separately each tube in high-frequency stages. When metal tubes, and in particular the single-ended types, are used, complete shielding of each tube is provided by the metal shell which is grounded through its grounding pin as the socket terminal. The grounding connection should be short and sturdy. Many modern tubes of glass construction have internal shields, usually connected to the cathode; where present, these shields are indicated in the socket diagram.

Dress of Circuit Leads

At high frequencies such as are encountered in FM and television receivers, lead dress, that is, the location and arrangement of the leads used for connections in the receiver, is very important. Because even a short lead provides a large impedance at high frequencies, it is necessary to keep all high-frequency leads as short as possible. This precaution is especially important for ground connections and for all connections to bypass capacitors and high-frequency filter capacitors. The ground connections of plate and screen-grid bypass capacitors of each tube should be kept short and made directly to cathode ground.

Particular care should be taken with the lead dress of the input and output circuits of high-frequency stages so that the possibility of stray coupling is

minimized. Unshielded leads connected to shielded components should be dressed close to the chassis. As the frequency increases, the need for careful lead dress becomes increasingly important.

In high-gain audio amplifiers, these same precautions should be taken to minimize the possibility of self-oscillation.

Filters

Feedback effects also are caused in radio or television receivers by coupling between stages through common voltage-supply circuits. Filters find an important use in minimizing such effects. They should be placed in voltage-supply leads to each tube in order to return the signal current through a low-impedance path direct to the tube cathode rather than by way of the voltage-supply circuit. Fig. 90 illustrates several forms of filter circuits. Capacitor C forms the

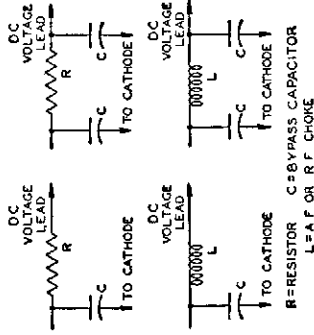

Fig. 90

low-impedance path, while the choke or resistor assists in diverting the signal through the capacitor by offering a high impedance to the power-supply circuit.

The choice between a resistor and a choke depends chiefly upon the permissible dc voltage drop through the filter. In circuits where the current is small (a

few milliamperes), resistors are practical; where the current is large or regulation important, chokes are more suitable.

The minimum practical size of the capacitors may be estimated in most cases by the following rule: The impedance of the capacitor at the lowest frequency amplified should not be more than one-fifth of the impedance of the filter choke or resistor at that frequency. Better results will be obtained in special cases if the ratio is not more than one-tenth.

Radio-frequency circuits, particularly at high frequencies, require high-quality capacitors. Mica or ceramic capacitors are preferable. Where stage shields are employed, filters should be placed within the shield.

Another important application of filters is to smooth the output of a rectifier tube. See Rectification. A smoothing filter usually consists of capacitors and iron-core chokes. In any filter-design problem, the load impedance must be considered as an integral part of the filter because the load is an important factor in filter performance. Smoothing effect is obtained from the chokes because they are in series with the load and offer a high impedance to the ripple voltage. Smoothing effect is obtained from the capacitors because they are in parallel with the load and store energy on the voltage peaks; this energy is released on the voltage dips and serves to maintain the voltage at the load substantially constant. Smoothing filters are classified as choke-input or capacitor-input according to whether a choke or capacitor is placed next to the rectifier tube. See Fig. 91.

The CIRCUIT SECTION gives a number of examples of rectifier circuits with recommended filter constants.

If an input capacitor is used, consideration must be given to the instan-

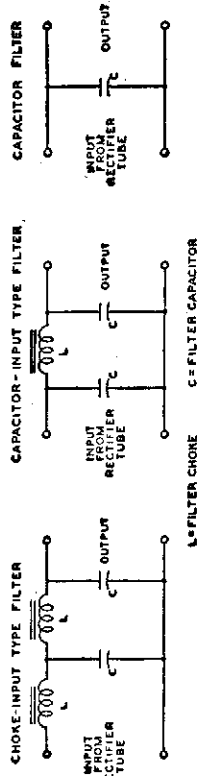

Fig. 91

up head, a magnetic phonograph pickup, or a dynamic microphone, the transmitter should be completely shielded and positioned to prevent its field from inducing hum in the pickup device.

High-Voltage Considerations for Television Picture Tubes

Like other high-voltage devices, television picture tubes require that certain precautions be observed to minimize the possibility of failure caused by humidity, dust, and corona.

Humidity Considerations. When humidity is high, a continuous film of moisture may form on the glass bulb immediately surrounding the ulior cavity cap of all-glass picture tubes or on the glass part of the envelope of metal picture tubes. This film may permit sparking to take place over the glass surface to the external conductive coating or to the metal shell. Such sparking may introduce noise into the receiver. To prevent such a possibility, the uncoated bulb surface around the cap and the glass part of the envelope of metal picture tubes should be kept clean and dry.

Dust Considerations. The accumulation of dust on the uncoated area of the bulb around the ulior cap of all-glass picture tubes or on the glass part of the envelope or insulating supports for metal picture tubes will decrease the insulating qualities of these parts. The dust usually consists of fibrous materials and may contain soluble salts. The fibers absorb and retain moisture; the soluble salts provide electrical leakage paths that increase in conductivity as the humidity increases. The resulting high leakage currents may overload the high-voltage power supply.

It is recommended, therefore, that the uncoated bulb surface of all-glass picture tubes and the coated glass surface and insulating supports for metal picture tubes be kept clean and free from dust or other contamination such as finger-prints. The frosted Filterglass faceplate of the metal picture tubes may be cleaned with a soapless detergent, such as Dreft, then rinsed with clean water, and immediately dried.

Corona Considerations. A high-voltage system may be subject to corona, especially when the humidity is high,

unless suitable precautions are taken. Corona, which is an electrical discharge appearing on the surface of a conductor when the voltage gradient exceeds the breakdown value of air, causes deterioration of organic insulating materials through formation of ozone, and induces arc-over at points and sharp edges. Sharp points or other irregularities on any part of the high-voltage system may increase the possibility of corona and should be avoided.

In the metal-shell picture tubes, the metal lip at the maximum diameter has rounded edges to prevent corona. Adequate spacing between the lip and any grounded element in the receiver, or between the small end of the metal shell and any grounded element, should be provided to preclude the possibility of corona. Such spacing should not be less than 1 inch of air. Similarly, an air space of 1 inch, or equivalent, should be provided around the body of the metal shell. As a further precaution to prevent corona, the deflecting-yoke surface on the end adjacent to the shell should present a smooth electrical surface with respect to the small end of the metal shell or the ulior terminal of all-glass tubes.

Picture-Tube Safety Considerations
Tube Handling. Breakage of picture tubes, which contain a high vacuum, may result in injury from flying glass. Do not strike or scratch the tube or subject it to more than moderate pressure when installing it in or removing it from electronic equipment.

High-Voltage Precautions. In picture-tube circuits, high voltages may appear at normally low-potential points in the circuit because of capacitor breakdown or incorrect circuit connections. Therefore, before any part of the circuit is touched the power-supply switch should be turned off, the power plug disconnected, and both terminals of any capacitors grounded.

X-Ray Radiation Precautions. All types of picture tubes may be operated at voltages (if ratings permit) up to 16 kilovolts without producing harmful x-ray radiation or danger of personal injury on prolonged exposure at close range. Above 16 kilovolts, special x-ray shielding precautions may be necessary.

Interpretation of Tube Data

The tube data given in the following TUBE TYPES SECTION include ratings, typical operation values, characteristics, and characteristic curves.

The values for grid-bias voltages, other electrode voltages, and electrode supply voltages are given with reference to a specified datum point as follows: For types having filaments heated with dc, the negative filament terminal is taken as the datum point to which other electrode voltages are referred. For types having filaments heated with ac, the mid-point (i.e., the center tap on the filament-transformer secondary, or the midpoint on a resistor shunting the filament) is taken as the datum point. For types having unipotential cathodes indirectly heated, the cathode is taken as the datum point.

Ratings are established on electron tube types to help equipment designers utilize the performance and service capabilities of each tube type to best advantage. Ratings are given for those characteristics which careful study and experience indicate must be kept within certain limits to insure satisfactory performance.

Three rating systems are in use by the electron-tube industry. The oldest is known as the Absolute Maximum system, the next as the Design Center system, and the latest and newest as the Design Maximum system. Definitions of these systems have been formulated by the Joint Electron Tube Engineering Council (JETEC)* and standardized by the National Electrical Manufacturers Association (NEMA) and the Electronic Industries Association (EIA) as follows:

Absolute Maximum ratings are limiting values which should not be exceeded with any tube of the specified type under any condition of operation. These ratings are used only in rare instances for receiving types, but are gen-

erally used for transmitting and industrial types.

Design Center ratings are limiting values which should not be exceeded with a tube of the specified type having characteristics equal to the published values under normal operating conditions. These ratings, which include allowances for normal variations in both tube characteristics and operating conditions, were used for most receiving tubes prior to 1967. Unless specified otherwise, ratings given in the TUBE TYPES SECTION are based on the Design Center System.

Design Maximum ratings are limiting values which should not be exceeded with a tube of the specified type having characteristics equal to the published values under any conditions of operation. These ratings include allowances for normal variations in tube characteristics, but do not provide for variations in operating conditions. Design Maximum ratings were adopted for receiving tubes in 1967.

Electrode voltage and current ratings are in general self-explanatory, but a brief explanation of other ratings will aid in the understanding and interpretation of tube data.

Heater warm-up time is defined as the time required for the voltage across the heater to reach 80 per cent of the rated value in the circuit shown in Fig. 94. The heater is placed in series with a

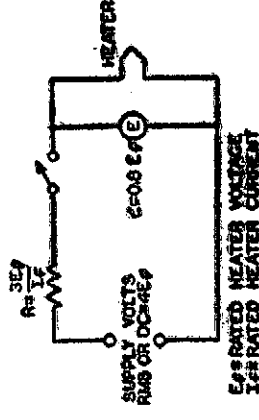

Fig. 94

*Now identified as the Joint Electron Device Engineering Council (JEDEC).

resistance having a value 3 times the nominal heater operating resistance ($R = 3 E_r/I_h$), and a voltage having a value 4 times the rated heater voltage ($V = 4 E_r$) is then applied. The warm-up time is determined when $E = 0.8 E_r$.

Plate dissipation is the power dissipated in the form of heat by the plate as a result of electron bombardment. It is the difference between the power supplied to the plate of the tube and the power delivered by the tube to the load.

Grid-No.2 (Screen-grid) Input is the power applied to the grid-No. 2 electrode and consists essentially of the power dissipated in the form of heat by grid No. 2 as a result of electron bombardment. With tetrodes and pentodes, the power dissipated in the screen-grid circuit is added to the power in the plate circuit to obtain the total B-supply input power.

When the screen-grid voltage is supplied through a series voltage-dropping resistor, the maximum screen-grid voltage rating may be exceeded, provided the maximum screen-grid dissipation is not exceeded at any signal condition, and the maximum screen-grid voltage rating is not exceeded at the

maximum-signal condition. Provided these conditions are fulfilled, the screen-grid supply voltage may be as high as, but not above, the maximum plate voltage rating.

For certain voltage amplifier types, as listed in the data section, the maximum permissible screen-grid (grid-No.2) input varies with the screen-grid voltage, as shown in Fig. 95. (This curve cannot be assumed to apply to types other than those for which it is specified in the data section.) Full rated screen-grid input is permissible at screen-grid voltages up to 50 per cent of the maximum rated screen-grid supply voltage. From the 50-per-cent point to the full rated value of supply voltage, the screen-grid input must be decreased. The decrease in allowable screen-grid input follows a curve of the parabolic form. This rating chart is useful for applications utilizing either a fixed screen-grid voltage or a series screen-grid voltage-dropping resistor. When a fixed voltage is used, it is necessary only to determine that the screen-grid input is within the boundary of the operating area on the chart at the selected value of screen-grid voltage to be used. When a voltage-dropping resistor is used, the

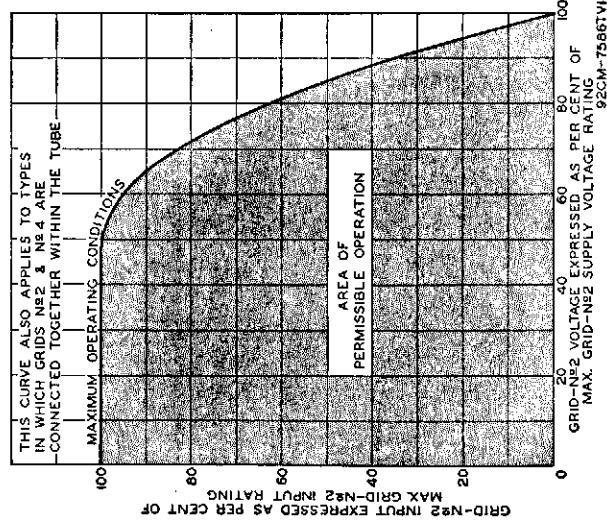

Fig. 95

minimum value of resistor that will assure tube operation within the boundary of the curve can be determined from the following relation:

$$R_{gr} \geq \frac{E_{ca} (E_{cca} - E_{ca})}{P_{ca}}$$

where R_{gr} is the minimum value for the voltage-dropping resistor in ohms, E_{ca} is the selected screen-grid voltage in volts, E_{cca} is the screen-grid supply voltage in volts, and P_{ca} is the screen-grid input in watts corresponding to E_{ca} .

Peak heater-cathode voltage is the highest instantaneous value of voltage that a tube can safely stand between its heater and cathode. This rating is applied to tubes having a separate cathode terminal and used in applications where excessive voltage may be introduced between heater and cathode.

Maximum dc output current is the highest average plate current which can be handled continuously by a rectifier tube. Its value for any rectifier tube type is based on the permissible plate dissipation of that type. Under operating conditions involving a rapidly repeating duty cycle (steady load), the average plate current may be measured with a dc meter.

The nomograph shown in Fig. 96 can be used to determine tube voltage drop or plate current for any diode unit when values for a single plate-voltage, plate-current condition are available from the data. It can also be used to compare the relative perveance ($G = I_p/E_b^{3/2}$) of several diodes. Perveance can be considered a figure of merit for diodes; high-perveance units have lower voltage drop at a fixed current level.

Tube voltage drop or plate current for a specific diode unit can be determined as follows: First, convenient values are selected for the plate-voltage and plate-current scales of the nomograph. The published plate-current and plate-voltage values are then located on the scales and connected with a straight edge. The intersection of the connecting line with the perveance scale is then used as a pivot point to determine the value of tube voltage drop corresponding to a desired current value, or the value of plate current corresponding to a desired tube voltage drop. Because the pivot point for a specific diode unit rep-

resents its perveance, the pivot points for several units (plotted to the same scales) can be used to compare their relative perveance.

For example, type 5U4GB has a tube voltage drop (per plate) of 44 volts at a plate current of 225 milliamperes.

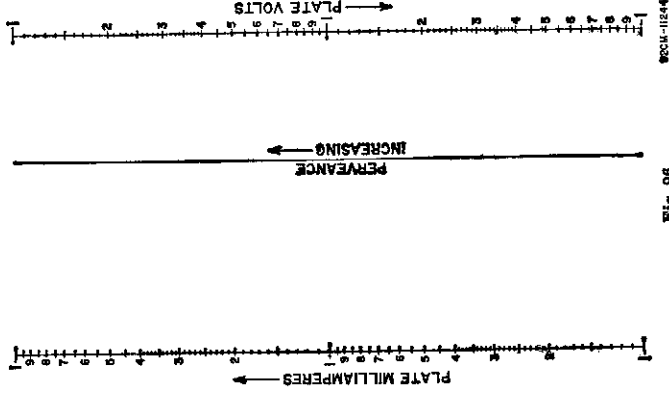

Fig. 96

Convenient scales for this type are from 1 to 100 volts for plate voltage and from 10 to 1000 milliamperes for plate current. The points 44 volts and 225 milliamperes are then connected with a straight line to determine the pivot point. Using this pivot point, it is easy to determine such values as a plate current of 150 milliamperes at a tube voltage drop of 33 volts, or a voltage drop of 25 for a current of 100 milliamperes.

For readings in the order of one volt and/or one milliampere, the nomograph is not accurate because of the effects of contact potential and initial electron velocity.

Maximum peak plate current is the highest instantaneous plate current that a tube can safely carry recurrently in the direction of normal current flow.

The safe value of this peak current in hot-cathode types of rectifier tubes is a function of the electron emission available and the duration of the pulsating current flow from the rectifier tube in each half-cycle.

The value of peak plate current in a given rectifier circuit is largely determined by filter constants. If a large choke is used at the filter input, the peak plate current is not much greater than the load current; but if a large capacitor is used as the filter input, the peak current may be many times the load current. In order to determine accurately the peak plate current in any rectifier circuit, measure it with a peak-indicating meter or use an oscillograph.

Maximum peak inverse plate voltage is the highest instantaneous plate voltage which the tube can withstand recurrently in the direction opposite to that in which it is designed to pass current. For mercury-vapor tubes and gas-filled tubes, it is the safe top value to prevent arc-back in the tube operating within the specified temperature range.

Referring to Fig. 97, when plate A of a full-wave rectifier tube is positive, current flows from A to C, but not from B to C, because B is negative. At the instant plate A is positive, the filament is positive (at high voltage) with respect to plate B. The voltage between the positive filament and the negative plate B is

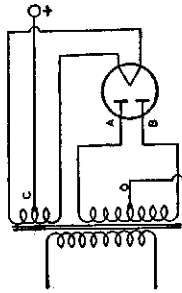

Fig. 97

in inverse relation to that causing current flow. The peak value of this voltage is limited by the resistance and nature of the path between plate B and filament. The maximum value of this voltage at which there is no danger of breakdown of the tube is known as maximum peak inverse voltage.

The relations between peak inverse voltage, rms value of ac input voltage, and dc output voltage depend largely on the individual characteristics of the rec-

tifier circuit and the power supply. The presence of line surges or any other transient, or wave-form distortion, may raise the actual peak voltage to a value higher than that calculated for sine-wave voltages. Therefore, the actual inverse voltage, and not the calculated value, should be such as not to exceed the rated maximum peak inverse voltage for the rectifier tube. A calibrated cathode-ray oscillograph or a peak-indicating electronic voltmeter is useful in determining the actual peak inverse voltage.

In single-phase, full-wave circuits with sine-wave input and with no capacitor across the output, the peak inverse voltage on a rectifier tube is approximately 1.4 times the rms value of the plate voltage applied to the tube. In single-phase, half-wave circuits with sine-wave input and with capacitor input to the filter, the peak inverse voltage may be as high as 2.8 times the rms value of the applied plate voltage. In polyphase circuits, mathematical determination of peak inverse voltage requires the use of vectors.

The Rating Chart for full-wave rectifiers presents graphically the relationships between maximum ac voltage input and maximum dc output current derived from the fundamental ratings for conditions of capacitor-input and choke-input filters. This graphical presentation provides for considerable latitude in choice of operating conditions.

The Operation Characteristics for a full-wave rectifier with capacitor-input filter show by means of boundary line the limiting current and voltage relationships presented in the Rating Chart.

The Operation Characteristics for a full-wave rectifier with choke-input filter not only show by means of boundary line the limiting current and voltage relationships presented in the Rating Chart, but also give some information as to the effect on regulation of various sizes of chokes. The solid-line curves show the dc voltage outputs which would be obtained if the filter chokes had infinite inductance. The long-dash lines radiating from the zero position are boundary lines for various sizes of chokes as indicated. The intersection of one of these lines with a solid-line curve indi-

icates the point on the curve at which the choke no longer behaves as though it had infinite inductance. To the left of the choke boundary line, the regulation curves depart from the solid-line curves as shown by the representative short-dash regulation curves.

Typical Operation Values. Values for typical operation are given for many types in the TUBE TYPES SECTION. These typical operating values are given to show concisely some guiding information for the use of each type. These values should not be confused with ratings, because a tube can be used under any suitable conditions within its maximum ratings, according to the application.

The power output value for any operating condition is an approximate tube output—that is, plate input minus plate loss. Circuit losses must be subtracted from tube output in order to determine the useful output.

Characteristics are covered in the ELECTRON TUBE CHARACTERISTIC SECTION and such data should be interpreted in accordance with the definitions given in that section. Characteristic curves represent the characteristics of an average tube. Individual tubes, like any manufactured product, may have characteristics that range above or below the values given in the characteristic curves.

Although some curves are extended well beyond the maximum ratings of the tube, this extension has been made only for convenience in calculations. Do NOT operate a tube outside of its maximum ratings.

Interelectrode capacitances are direct capacitances measured between specified elements or groups of elements in electron tubes. Unless otherwise indicated in the data, all capacitances are measured with filament or heater cold, with no direct voltages present, and with no external shields. All electrodes other than those between which capacitance is being measured are grounded. In twin or multi-unit types, inactive units are also grounded.

The capacitance between the input electrode and all other electrodes, except the output electrode, connected together is commonly known as the input capacitance. The capacitance between the out-

put electrode and all other electrodes, except the input electrode, connected together is known as the output capacitance.

Hum and noise characteristics of high-fidelity audio amplifier tube types such as the 7025 and the 7199 are tested in an amplifier circuit such as that shown in Fig. 98. The output of the test circuit is fed into a low-noise amplifier. The

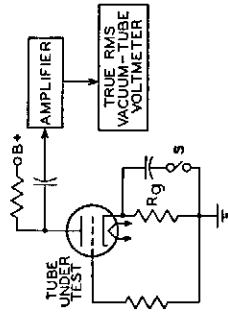

Fig. 98

bandwidth of this amplifier depends on the characteristic being measured. If hum alone is being tested, a relatively narrow bandwidth is used to include both the line frequency and the major harmonics generated by the tube under test. In noise or combination hum-and-noise measurements, the bandwidth is defined in the registration of the tube type.

The amplifier gain is calibrated so that the vacuum-tube voltmeter measures hum and noise in microvolts referred to the grid of the tube under test. A pentode can also be evaluated in this manner by the addition of a screen-grid supply adequately bypassed at the tube screen-grid pin connection. Power-supply ripple at the plate of the tube under test must be negligible compared to its hum and noise output. Extraordinary shielding of both the test socket and the associated operating circuit is required to minimize capacitances between heater leads and high-impedance connections.

The test-circuit components are determined by the tube type being tested and the type of hum to be controlled. Heater-cathode hum can be eliminated from the measurement by closing S₁. The circuit can also be made more or less sensitive to heater-grid hum by increasing or decreasing the grid resistance R_g. No circuit changes affect the component of magnetic hum generated by the tube.

Application Guide for RCA Receiving Tubes

In the Application Guide on the following pages, RCA receiving tubes are classified in two ways: (a) by function, and (b) by structure (diode, triode, etc.). The functional classification covers 38 principal types of application, as listed below.

Tube types are grouped by structure under each classification; they are also keyed to indicate miniature, octal, novistor, and novar types.

Triodes are designated as *low*, *medium*, or *high-mu* types on the following basis: *low*, less than 10; *medium*, 10 or more, but less than 50; *high*, 50 or more.

Where applicable, tubes are designated as *sharp*, *semiremote*, or *remote-cutoff* on the basis of the ratio, in per cent, of the negative control-grid voltage to the screen-grid voltage (or, for triodes, the plate voltage) as given in the characteristics or typical operation values. These terms are defined as follows: *sharp*, less than 10 per cent; *semiremote*, 10 or more, but less than 20 per cent; *remote*, 20 per cent or more.

For more complete data on these types, refer to the TECHNICAL DATA FOR RCA RECEIVING TUBES starting on page 83.

APPLICATIONS:

- | | | |
|--|---|----------------------------------|
| 1. Audio-Frequency Amplifiers | 13. Discriminators | 26. Phase Inverters |
| 2. Automatic Gain Control (AGC and AVC) Circuits | 14. Frequency Dividers | 27. Phase Splitters |
| 3. Burst Amplifiers | 15. FM Detectors | 28. Radio-Frequency Amplifiers |
| 4. Cathode-Drive RF Amplifiers (Grounded-Grid) | 16. Gated Noise, AGC, and Sync Amplifiers | 29. Reactance Circuits |
| 5. Color Killers | 17. Harmonic Generators | 30. Rectifiers |
| 6. Color Matrixing Circuits | 18. Horizontal-Deflection Circuits | 31. Regulators |
| 7. Complex-Wave Generators | 19. Intermediate-Frequency Amplifiers | 32. Relay Control Circuits |
| 8. Converters | 20. Limiters | 33. Sync Amplifiers |
| 9. Dampers | 21. Mixers—RF | 34. Sync Clippers |
| 10. Demodulators (Color TV) | 22. Mixer-Oscillators—RF | 35. Sync Separators |
| 11. Detectors | 23. Multivibrators | 36. Tuning Indicators |
| 12. DC Restorers | 24. Noise Inverters | 37. Vertical-Deflection Circuits |
| | 25. Oscillators | 38. Video Amplifiers |

I. AUDIO-FREQUENCY AMPLIFIERS

Voltage Amplifiers

- Medium-Mu Triode with Twin Diode
- 6BF6
 - 6SR7
 - 12BF6
 - 12SR7

Medium-Mu Triode—Sharp-Cutoff Pentode

- 7199 †
- Medium-Mu Twin Triode
- 5J6
 - 6J6A
 - 6SN7GTB
 - 7AU7
 - 9AU7
 - 12A7A
 - 12SN7GTA
 - 19J6

High-Mu Triode

- 12SF5
- High-Mu Triode with Twin Diode
- 3AV6
 - 4AV6
 - 6AT6
 - 6AV6
 - 6BN8
 - 6CN7
 - 6SQ7
 - 6SQ7GT
 - 12AT6
 - 12AV6
 - 18F7A
 - 18FY6A
 - 12SQ7
 - 12SQ7GT
 - 14CT8
 - 18F76
 - 18FY6A
 - 19T8

High-Mu Triode with Triple Diode

- 5T8
- High-Mu Twin Triode
- 6EU7 †
 - 6SL7CT
 - 12AX7 †
 - 12AX7A †
 - 12L7GT
 - 12AZ7
 - 12AZ7A
 - 20E27
 - 7025 †

• Miniature ◦ Octal ▷ Novistor ▶ Novar † For high-fidelity equipment.

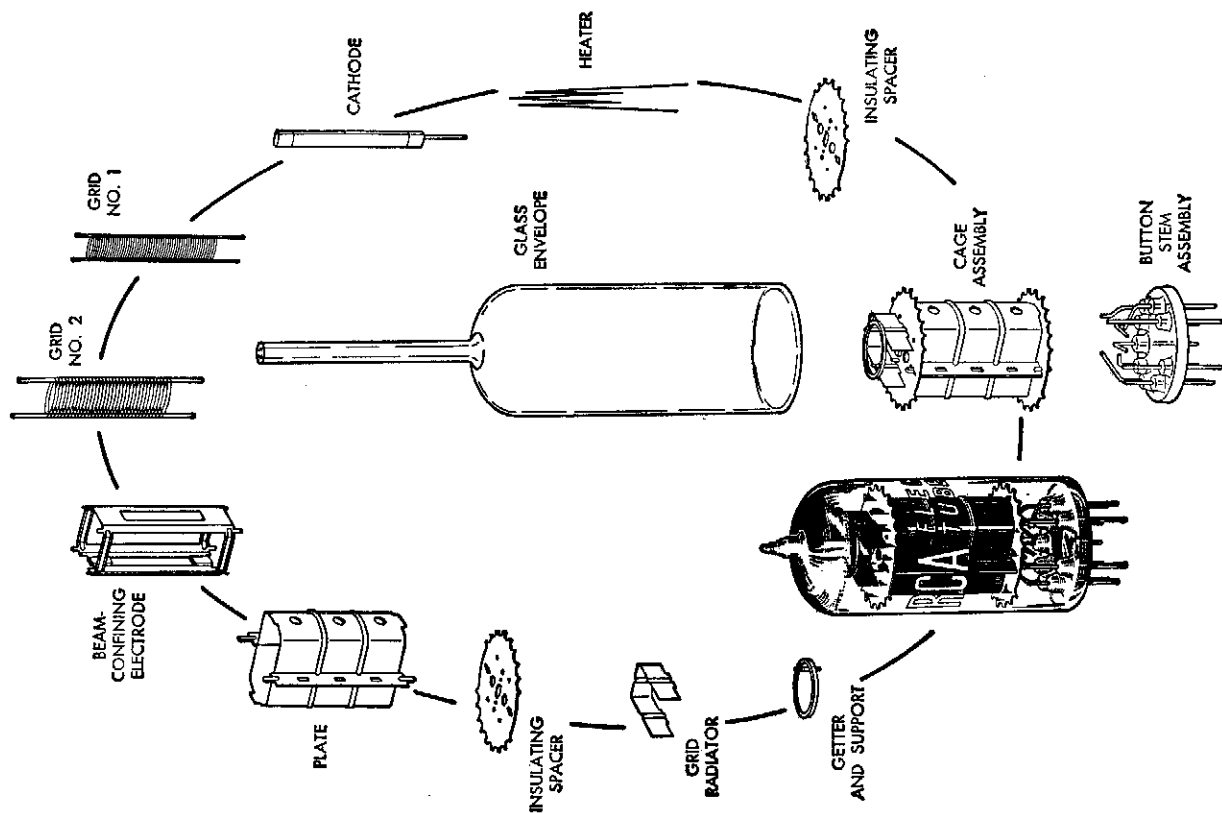

Parts of a Novar Tube

15. FM DETECTORS

(See 13. DISCRIMINATORS)

16. GATED NOISE, AGC, AND SYNC AMPLIFIERS

High-Mu Triode—Sharp-Cutoff Pentode
 • 6KA8 • 8KAB

Sharp-Cutoff Pentode
 • 6CY6*

Pentagrid Amplifier
 • 3BY6 • 6BY6 r • 6CS6

• 3CS6

17. HARMONIC GENERATORS

(See 7. COMPLEX-WAVE GENERATORS)

18. HORIZONTAL-DEFLECTION CIRCUITS

Oscillators

Medium-Mu Triode—Sharp-Cutoff Pentode
 • 5CB8 • 6GB8

Medium-Mu Twin Triode
 • 6CC7 • 8CC7

• 6FQ7 • 8FQ7 • 12AU7 • 12BH7A • 6SN7GTB • 9AU7 • 12SN7-GTA

Amplifiers

Beam Power Tube
 • 6AU5GT • 6CW6 • 17BQ6-6TB • 6AV5GA • 6JB6 • 17DQ6B • 6BC6A • 6JE6 • 17DQ6B • 6BQ6GTB/6C6 • 12AV5GA • 17GJ5 • 6CT5 • 12BQ6GTB/6CU6 • 17CW6 • 6CB5A • 18CU6 • 17CW6 • 6CD6GA • 12DQ6A • 17JB6 • 6DN6 • 12DQ6B • 22JG6 • 6DQ5 • 12GJ5 • 12GJ5 • 25AV5CA • 6PQ6B • 12CT5 • 25BQ6-6TB/25CU6 • 6EX6 • 12GW6 • 6CJ5 • 12JB6 • 25CD6GB • 6CT5 • 25DN6

19. INTERMEDIATE-FREQUENCY AMPLIFIERS

Medium-Mu Triode—Sharp-Cutoff Tetrode
 • 5CQ8 • 6CQ8

Medium-Mu Triode—Sharp-Cutoff Pentode
 • 5AN8 • 6AZ8 • 6CJ8 • 6AN8A • 6BH8 • 6CX8 • 6AU8A • 6CB8 • 6CX8

• Miniature • Octal • Nuviator • Novar • Dual-control grids

High-Mu Triode—Sharp-Cutoff Pentode
 • 6AW8A • 6KY8 • 8JVB • 6CN8 • 10HF8 • 8AW8A • 6HR8 • 11KV8 • 6JVB • 8GN8

Sharp-Cutoff Pentode
 • 3AU6 • 5EW6 • 6DC6 • 3CB5 • 6AB7 • 6DB6 • 3CB6 • 6AC7 • 6DK6 • 3CF6 • 6AH6 • 6EJ7 • 3DK6 • 6AG5 • 6EW6 • 3JC6 • 6AK5 • 6HS6 • 3JD6 • 6AUG • 6JDE • 4AU6 • 6AUG • 6JD6 • 4CB6 • 12AU6 • 6BC5 • 4EW6 • 6CB6 • 12AW6 • 4JC6 • 6CB6A • 18CD6A • 4JD6 • 6CF6 • 19HS6

Sharp-Cutoff Pentode with Diode
 • 5AM8 • 6AMB8 • 6KLB • 5AS8 • 6AS8 • 12KLB

Semiremote-Cutoff Pentode
 • 3BZ6 • 6EH7 • 6JB6 • 4BZ6 • 6CM6 • 12Z6 • 5CM6 • 6HR6 • 19HB6 • 6BZ6

Remote-Cutoff Pentode
 • 6BA6 • 12BA6 • 6JH6 • 6SK7 • 12SK7 • 6SK7CT • 12SK7CT • 18FW6 • 18FW6A

Remote-Cutoff Pentode with Diode
 • 6EQ7 • 12EQ7 • 20EQ7

20. LIMITERS

Beam Tube
 • 3BN6 • 4BN6 • 6BN6

Sharp-Cutoff Pentode
 • 3AU6 • 6GX6 • 12AU6 • 4AV • 6HS6 • 12SH7 • 5GX6 • 6HZ6 • 19HS6 • 6AU6A • 6SH7

Sharp-Cutoff Pentode with Diode
 • 6KL8 • 12KL8

21. MIXERS—RF

Medium-Mu Twin Triode
 • 5J6 • 12AV7 • 6J6A

High Mu Triode
 • 2CW4 • 6AB4 • 6CW4

22. MIXER-OSCILLATORS—RF

Medium-Mu Triode—Sharp-Cutoff Tetrode
 • 5CL8A • 6CL8A • 6CQB • 5CQB

• Approaches semiremote-cutoff characteristics; used in first-if amplifier applications

Medium-Mu Triode—Sharp-Cutoff Pentode
 • 5AT8 • 5UH • 6FG7 • 5B8 • 5X8 • 6KE8 • 5HR8 • 6AT8A • 6C8A • 5CC8 • 6HR8A • 6X8 • 5EA8 • 6GC8A • 19EA8 • 5KE8 • 6EA8 • 19X8

High-Mu Twin Triode
 • 6DT8 • 12AT7 • 12DT8

Triode-Hexode
 • 6K8 • 12K8

23. MULTIVIBRATORS

Medium-Mu Triode—Sharp-Cutoff Pentode
 • 5GH8 • 6GH8 • 6GH8A

Medium-Mu Twin Triode
 • 6CC7 • 7AU7 • 12SN7-GTA • 6GU7 • 9AU7 • 12SN7-GTA • 6SN7GTB • 12AU7A • 12AX7A

High-Mu Twin Triode
 • 12AX7 • 12AX7A

24. NOISE INVERTERS

High-Mu Triode—Sharp-Cutoff Pentode
 • 6KA8 • 8KA8

Sharp-Cutoff Pentode
 • 6CY6*

25. OSCILLATORS

Radio Frequency—UHF
 Medium-Mu Triode
 • 2AF4B • 3AF4A • 6AF4A • 2DV4 • 3DZ4 • 6DV4 • 2DZ4 • 6AF4 • 6DZ4

Radio Frequency—VHF
 Medium-Mu Twin Triode
 • 5J6 • 12AV7 • 19J6 • 6J6A

High-Mu Triode
 • 6AB4

Power Triode
 • 6C4 (Class C)

Low Frequency, Sweep Type
 Medium-Mu Triode—Sharp-Cutoff Pentode
 • 5AN8 • 6RA8A • 6CUB • 6AN8A • 6RH8 • 6CX8 • 6A8A • 6CH8 • 8CX8 • 6AZ8

High Mu Triode with Twin Diode
 • 6BN8 • 6CN7

High-Mu Triode—Sharp-Cutoff Pentode
 • 6AW8A • 8AW8A

• Miniature • Octal • Nuviator • Novar • Dual-control grids

High-Mu Twin Triode
 • 12AX7 • 12AX7A

26. PHASE INVERTERS

Medium-Mu Triode—High-Mu Triode
 • 12DW7

Medium-Mu Twin Triode
 • 6CC7 • 7AU7 • 12SN7-GTA • 6CU7 • 9AU7 • 12AU7A • 6SN7GTB • 12AU7A

High-Mu Triode—Sharp-Cutoff Pentode
 • 6AW8A • 6HF8 • 8GN8 • 6EB8 • 8AW8A • 10HF8 • 6GN8 • 8EB8

High-Mu Twin Triode
 • 6SC7 • 12AX7A • 6SL7GT • 12SC7 • 12AX7 • 12SL7GT • 7G25

27. PHASE SPLITTERS

Medium-Mu Triode—Sharp-Cutoff Tetrode
 • 5CQ8 • 6CQ8

Medium-Mu Triode—Sharp-Cutoff Pentode
 • 5AN8 • 6BABA • 6CL8 • 6AN8 • 6CH8 • 7J99 • 6AZ8

High-Mu Triode—Sharp-Cutoff Pentode
 • 6AW8A • 8AW8A

28. RADIO-FREQUENCY AMPLIFIERS

Medium-Mu Triode
 • 2BN4A • 6BC4 • 6RN4A • 3BN4A

Medium-Mu Twin Triode
 • 4BL8 • 5J6 • 6BZ7 • 4BQ7A • 6BC8 • 6FW8 • 4BS8 • 6BK7B • 6J6A • 4BZ7 • 6BQ7A • 12AV7 • 5BK7A • 6BS8 • 5BQ7A

High-Mu Triode
 • 6AB4 • 6AB4 • 6AB4 • 2CW4 • 6CW4 • 2DS4 • 2FH5 • 3GK5 • 6ER5 • 6ER5 • 12AZ7A • 12DT8 • 6DFF • 12AZ7A • 12AZ7

• Miniature • Octal • Nuviator • Novar • Dual-control grids

Technical Data for RCA Tube Types

This section contains technical descriptions of RCA tubes used in standard broadcast, FM, and television receivers, in audio amplifiers, and in many other diverse applications. It includes data on current types, as well as information on those RCA discontinued types in which there may still be some interest. Unless otherwise specified, the ratings given are based on the Design Center system. Information on picture tubes is shown at the end of this section.

In choosing tube types for the design of new electronic equipment, the designer should refer to the APPLICATION GUIDE FOR RCA RECEIVING TUBES on pages 75 to 81.

Tube types are listed in this section according to the numerical-alphabetical-numerical sequence of their type designations. For Key: Basing Diagrams, see inside back cover.

- 1—Glass Envelope
- 2—Internal Shield
- 3—Plate
- 4—Grid No. 3 (Suppressor)
- 5—Grid No. 2 (Screen)
- 6—Grid No. 1 (Control Grid)
- 7—Cathode
- 8—Heater
- 9—Exhaust Tip
- 10—Getter
- 11—Spacer Shield Header
- 12—Insulating Spacer
- 13—Spacer Shield
- 14—Inter-Pin Shield
- 15—Glass Button-Stem Seal
- 16—Lead Wire
- 17—Base Pin
- 18—Glass-to-Metal Seal

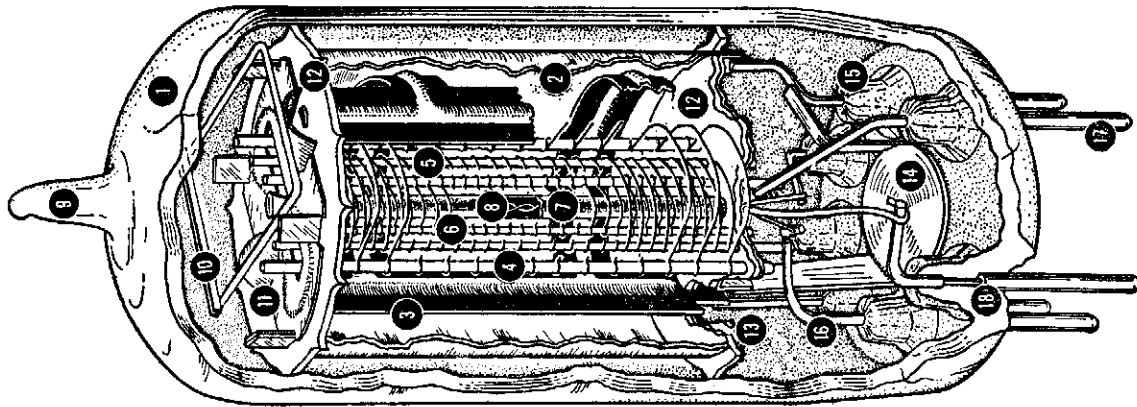

Structure of a Miniature Tube

DIODE

Miniature type used as detector tube in portable FM receivers and in portable high-frequency measuring equipment. Outline 7B, OUTLINES SECTION. Tube requires miniature seven-contact socket. Heater volts (ac/dc), 1.4; amperes, 0.15. Maximum ratings for half-wave rectifier service: peak inverse plate volts, 330 *max*; peak plate ma, 5 *max*; dc output ma., 0.5 *max*; peak heater-cathode volts, 140 *max*. This type is used principally for renewal purposes.

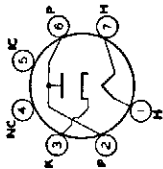

1A3

REMOTE-CUTOFF PENTODE

Glass type used in battery-operated receivers as rf or if amplifier. This type is similar electrically to type 1D5-GP. Outline 24B, OUTLINES SECTION. Tube requires four-contact socket. Filament volts (dc), 2.0; amperes, 0.06. Type 1A4-P is a DISCONTINUED type listed for reference only.

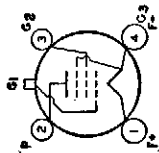

1A4P

POWER PENTODE

Glass octal type used in output stage of battery-operated receivers. Outline 14C, OUTLINES SECTION. This type may be supplied with pin No.1 omitted. Tube requires octal socket and may be mounted in any position. For filament considerations, refer to type 1U4. Filament volts (dc), 1.4; amperes, 0.06. Typical operation as class A₁ amplifier: plate and grid-No.2 volts, 90 (110 *max*); grid-No.1 volts, -4.5; peak of grid-No.1 volts, 4.0; grid-No.2 ma., 1.1; plate resistance (approx.), 0.8 megohm; transconductance, 850 μ mhos; load resistance, 25000 ohms; power output, 115 milliwatts. Type 1A6-GT is used principally for renewal purposes.

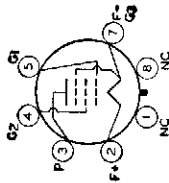

1A5GT

1A5GT

1A6

PENTAGRID CONVERTER

Glass type used in battery-operated receivers. This type is identical electrically with type 1D7-G, except for interelectrode capacitances. Outline 24B, OUTLINES SECTION. Tube requires six-contact socket. Filament volts (dc), 2.0; amperes, 0.06. Type 1A6 is a DISCONTINUED type listed for reference only.

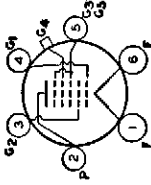

1A7GT

PENTAGRID CONVERTER

Glass octal type used in superheterodyne circuits having battery power supplies. Outline 15A, OUTLINES SECTION. Tube requires octal socket and may be mounted in any position. Filament volts (dc), 1.4; amperes, 0.05. Typical operation as converter: plate and grid-No.2 volts, 90 (110 maz); grids-No.3 and-No.5 supply volts, 110 maz; grids-No.3 and-No.5 volts, 45 (60 maz); grid-No.4 volts, 0; grid-No.1 resistor, 0.2 megohm; plate ma., 0.6; grids-No.3 and-No.5 ma., 0.7; grid-No.2 ma., 1.2; grid-No.1 ma., 0.035; total cathode ma., 2.5 (4 maz); conversion transconductance, 250 amhos. This type is used principally for renewal purposes.

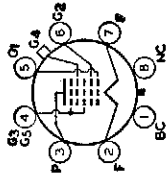

1A6S

POWER PENTODE

Subminiature type used in output stage of small, compact, battery-operated receivers for the standard AM broadcast band. Maximum dimensions: over-all length, 1.75 inches; seated height, 1.5 inches; diameter, 0.4 inch. Tube requires subminiature eight-contact socket. Filament volts (dc), 1.25; amperes, 0.04. Filament voltage should never exceed 1.6 volts. Typical operation as Class A1 amplifier: plate and grid-No.2 volts, 67.5 maz; grid-No.1 volts, -4.5; zero-signal plate ma., 2; zero-signal grid-No.2 ma., 0.4; cathode ma., 4 maz; plate resistance, 0.15 megohm; transconductance, 750 amhos; load resistance, 25000 ohms; total harmonic distortion, 10 per cent; maximum-signal power output, 50 milliwatts. This is a DISCONTINUED type listed for reference only.

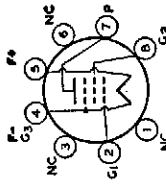

1AD2

HALF-WAVE VACUUM RECTIFIER

Duodecax type used to supply power to the anode of the picture tube in television receivers. Outline 16A, OUTLINES SECTION. Tube requires duodecax twelve-contact socket

and may be mounted in any position. Socket terminals 4 and 10 may be used as tie points for components at or near filament potential. Filament volts (ac/dc), 1.25; amperes, 0.2.

PULSED RECTIFIER

For operation in a 525-line, 30-frame system

Maximum Ratings, (Design-Maximum Values):	
PEAK INVERSE PLATE VOLTAGE#	26000* maz volts
PEAK PLATE CURRENT	50 maz ma
AVERAGE PLATE CURRENT	0.5 maz ma

Characteristics, Instantaneous Value:

Tube Voltage Drop for plate current of 7 ma. 225 volts

The duration of the voltage pulse must not exceed 15 per cent of one horizontal scanning cycle. In a 525-line, 30-frame system, 16 per cent of one horizontal scanning cycle is 10 microseconds.

* The dc component must not exceed 22000 volts.

1AD5

SHARP-CUTOFF PENTODE

Subminiature type used as rf or if amplifier in stages not controlled by AVC in small, compact, battery-operated receivers for the standard AM broadcast band. Maximum dimensions: over-all length, 1.75 inches; seated height, 1.5 inches; diameter, 0.4 inch. Tube requires subminiature eight-contact socket. Filament volts (dc), 1.25; amperes, 0.04. Filament voltage should never exceed 1.6 volts. Characteristics as class A1 amplifier: plate and grid-No.1 volts, 0; plate resistance, 0.7 megohm; transconductance, 735 amhos; total cathode ma., 4 maz; plate ma., 1.85; grid-No.2 ma., 0.75. This is a DISCONTINUED type listed for reference only.

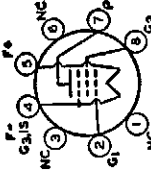

HALF-WAVE VACUUM RECTIFIER

Miniature type used as rectifier of high-voltage pulses produced in the scanning systems of television receivers. Outline 9A, OUTLINES SECTION. Tube requires miniature nine-contact socket. Socket terminals 3 and 7 may be connected to the filament, or used as tie points for the filament-dropping resistor; otherwise they should not be used. Filament volts (ac), 1.4; amperes, 0.55. Maximum ratings as pulsed rectifier in 525-line, 30-frame system: peak inverse plate volts (absolute maximum), 25000 maz (dc 20000 maz); peak plate ma., 11 maz; average plate ma., 1 maz. For filament and high-voltage considerations, refer to type 1B3-GT. Type 1AX2 is used principally for renewal purposes.

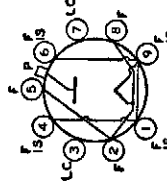

HALF-WAVE VACUUM RECTIFIER

Glass octal type used in high-voltage, low-current applications such as the rectifier in a high-voltage, rf-operated power supply or as a rectifier of high-voltage pulses produced in television scanning systems.

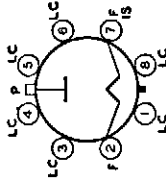

FILAMENT VOLTAGE (AC/DC)	1.25* volts
FILAMENT CURRENT	0.2 ampere
DIRECT INTERELECTRODE CAPACITANCE (Approx.):	
Plate to Filament and Internal Shield	1.3 pf

PULSED RECTIFIER

For operation in a 525-line, 30-frame system

Maximum Ratings, (Design-Maximum Values):	
PEAK INVERSE PLATE VOLTAGE#	26000* maz volts
PEAK PLATE CURRENT	50 maz ma
AVERAGE PLATE CURRENT	0.5 maz ma

Characteristics, Instantaneous Value

Tube Voltage Drop for plate current of 7 ma. 100 volts

RADIO-FREQUENCY RECTIFIER

(Design-Maximum Values):

PEAK INVERSE PLATE VOLTAGE	39000 maz volts
PEAK PLATE CURRENT	35 maz ma
AVERAGE PLATE CURRENT	1.1 maz ma
FREQUENCY RANGE OF SUPPLY VOLTAGE	1.5 to 100 Kc

* The duration of the voltage pulse must not exceed 15 per cent of one horizontal scanning cycle. In a 525-line, 30-frame system, 16 per cent of one horizontal scanning cycle is 10 microseconds.

INSTALLATION AND APPLICATION

Type 1B8-GT requires an octal socket and may be mounted in any position. Plate connection is cap at top of bulb. Socket terminals 1, 3, 4, 5, 6, and 8 may be connected to socket terminal 7 or to a corona shield which is connected to socket terminal 7. Socket terminals 4 and 6 may be used as tie points for components at or near filament potential. This type may be supplied with pins 1, 4, and/or 6 omitted. Outline 15D, OUTLINES SECTION.

The high voltages at which the 1B3-GT is operated are very dangerous. Great care should be taken to prevent coming in contact with these high voltages. In those circuits where the filament circuit is not grounded, the filament circuit operates at dc potentials which can cause fatal shock. Extreme precautions must be taken when the filament voltage is measured. These precautions must include safeguards which definitely eliminate all hazards to personnel. The filament transformer, whether it is of the iron-core or the air-core type, must be sufficiently insulated.

The voltages employed in some television receivers and other high-voltage equipment may be sufficiently high to cause high-voltage rectifier tubes such as the 1B3-GT to produce soft X-rays which can constitute a health hazard unless the tubes are adequately shielded. Relatively simple shielding should prove adequate, but the need for this precaution should be considered.

SHARP-CUTOFF PENTODE

Glass type used as rf amplifier or detector in battery-operated receivers. Outline 24B, OUTLINES SECTION. Tube requires four-contact socket. For typical operating conditions and maximum ratings as a class A₁ amplifier, refer to type 1B5-GP. Filament volts (dc), 2.0; amperes, 0.06. Type 1B4-P is a DISCONTINUED type listed for reference only.

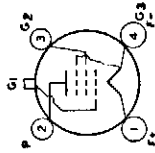

1B4P

TWIN DIODE — MEDIUM-MU TRIODE

Glass type used as combined detector, amplifier, and avc tube in battery-operated receivers. Maximum dimensions: over-all length, 4-3/16 inches; seated height, 8-9/16 inches; diameter, 1-9/16 inches. Tube requires six-contact socket. Filament volts (dc), 2.0; amperes, 0.06. Typical operation as class A₁ amplifier: plate volts, 185 max; grid volts, -8; plate ma., 0.8; plate resistance, 85000 ohms; amplification factor, 20; transconductance, 576 μ mhos. This is a DISCONTINUED type listed for reference only.

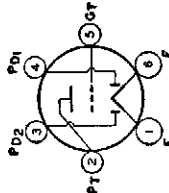

1B5/25S

PENTAGRID CONVERTER

Glass octal type used in superheterodyne circuits having battery power supply. Outline 15A, OUTLINES SECTION. Filament volts (dc), 1.4; amperes, 0.1. This is a DISCONTINUED type listed for reference only. The 1B7-GT may be replaced by the 1A7-GT if circuit adjustment is made for lower filament current of type 1A7-GT.

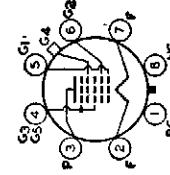

1B7GT

POWER PENTODE

Glass octal type used in output stage of battery-operated receivers. Outline 14C, OUTLINES SECTION. This type may be supplied with pin No.1 omitted. Tube requires octal socket. Filament volts (dc), 1.4; amperes, 0.1. Typical operation as class A₁ amplifier: plate and grid-No.2 volts, 90 (110 max); grid-No.1 volts, -7.5; peak at grid-No.1 volts, 7.5; plate ma., 7.8; grid-No.2 ma., 3.5; plate resistance (approx.), 115000 ohms; transconductance, 1550 μ mhos; load resistance, 8000 ohms; power output, 240 milliwatts. Type 1C5-GT is used principally for renewa (purposes).

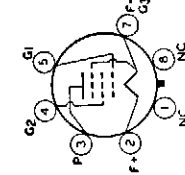

1C5GT

PENTAGRID CONVERTER

Glass type used in battery-operated receivers. Similar electrically to type 1C7-G except for interelectrode capacitances. Outline 24B, OUTLINES SECTION. Tube requires six-contact socket. Filament volts (dc), 2.0; amperes, 0.12. Type 1C6 is a DISCONTINUED type listed for reference only.

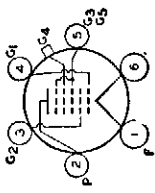

1C6

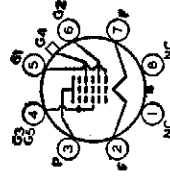

1C7G

PENTAGRID CONVERTER

Glass octal type used in battery-operated receivers. Outline 23, OUTLINES SECTION. Tube requires octal socket. Filament volts (dc), 2.0; amperes, 0.12. Typical operation as converter: plate volts, 180 max; grids-No.3-and-No.5 (screen-grid) volts, 67.5 max; grid-No.2 (control-grid) supply volts, 180 (applied through 20000-ohm dropping resistor bypassed by 0.01- μ f capacitor); grid-No.4 (control-grid) volts, -3; grid-No.1 (oscillator-grid) resistor, 50000 ohms; plate ma., 1.5; grids-No.3-and-No.5 ma., 2; grid-No.2 ma., 4; grid-No.1 ma., 0.2. This is a DISCONTINUED type listed for reference only.

Grid-No.1 (oscillator-grid) resistor, 50000 ohms; plate ma., 1.5; grids-No.3-and-No.5 ma., 2; grid-No.2 ma., 4; grid-No.1 ma., 0.2. This is a DISCONTINUED type listed for reference only.

REMOTE-CUTOFF PENTODE

Glass octal type used in battery-operated receivers as rf or if amplifier. Outline 23, OUTLINES SECTION. Tube requires octal socket. Filament volts (dc), 2.0; amperes, 0.06. Typical operation as class A₁ amplifier: plate volts, 180 max; grid-No.2 (screen-grid) volts, 67.5 max; grid-No.1 volts, -3 min; plate ma., 2.3; grid-No.2 ma., 0.8; plate resistance (approx.), 1.0 megohm; transconductance, 750 μ mhos; transconductance at bias of -15 volts, 15 μ mhos. This is a DISCONTINUED type listed for reference only.

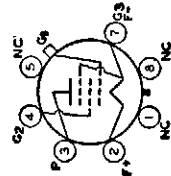

1D5GP

REMOTE-CUTOFF TETRODE

Glass octal type used in battery-operated receivers as rf or if amplifier. Outline 23, OUTLINES SECTION. Filament volts (dc), 2.0; amperes, 0.06. This is a DISCONTINUED type listed for reference only. It is similar electrically to type 1D5-GP.

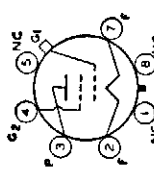

1D5GT

PENTAGRID CONVERTER

Glass octal type used in battery-operated receivers. Outline 23, OUTLINES SECTION. Tube requires octal socket. Filament volts (dc), 2.0; amperes, 0.06. Typical operation as converter: plate volts, grids-No.3-and-No.5 volts, grid-No.2 supply volts, grid-No.4 volts, and grid-No.1 resistor are same as for type 1C7-G; plate ma., 1.3; grids-No.3-and-No.5 ma., 2.4; grid-No.2 ma., 2.3; grid-No.1 ma., 0.2. This is a DISCONTINUED type listed for reference only.

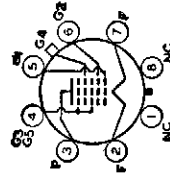

1D7G

DIODE — TRIODE — POWER PENTODE

Glass octal type used in compact, battery-operated receivers. Diode unit is used as detector or avc tube, triode as first audio amplifier, and pentode as power output tube. Outline 15A, OUTLINES SECTION. Tube requires octal socket. Filament volts (dc), 1.4; amperes, 0.1. Typical operation of pentode unit as class A₁ amplifier: plate and grid-No.2 volts, 90 (110 max); grid-No.1 volts, -9; plate ma., 5; grid-No.2 ma., 1; transconductance, 12000 μ mhos; total harmonic distortion, 10 per cent; power output, 200 milliwatts. Characteristics of triode unit as class A₁ amplifier: plate volts, 90 (110 max); grid volts, 0; amplification factor, 25; plate resistance (approx.), 43500 ohms; transconductance, 575 μ mhos; plate ma., 1.1. This is a DISCONTINUED type listed for reference only.

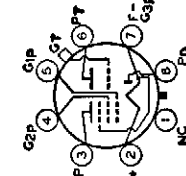

1D8GT

1; transconductance, 925 μ mhos; load resistance, 12000 ohms; total harmonic distortion, 10 per cent; power output, 200 milliwatts. Characteristics of triode unit as class A₁ amplifier: plate volts, 90 (110 max); grid volts, 0; amplification factor, 25; plate resistance (approx.), 43500 ohms; transconductance, 575 μ mhos; plate ma., 1.1. This is a DISCONTINUED type listed for reference only.

**DIODE—
SEMIREMOTE-CUTOFF PENTODE**

Miniature type used in battery-operated portable radio receivers as combined AM detector and af voltage amplifier. Outline 7B, OUTLINES SECTION. Tube requires miniature seven-contact socket and may be mounted in any position. Filament volts (dc), 1.4; amperes, 0.05. Characteristics of pentode unit as class A₁ amplifier: plate and grid-No.2 (screen-grid) volts, 67.5 (90 max); grid-No.1 volts, 0; plate resistance (approx.), 0.6 megohm; transconductance, 630 μ mhos; plate ma., 2.1; grid-No.2 ma., 0.55. Maximum diode rating: plate ma., 0.25 max. This type is used principally for renewal purposes.

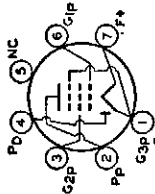

1D9S

1E5GP

SHARP-CUTOFF PENTODE

Glass octal type used as rf amplifier or detector in battery-operated receivers. Outline 23, OUTLINES SECTION. Tube requires octal socket. Filament volts (dc), 2.0; amperes, 0.06. Characteristics as class A₁ amplifier: plate volts, 180 max; grid-No.2 volts, 67.5 max; grid-No.1 volts, -5; plate ma., 1.7; grid-No.2 ma., 0.6; plate resistance, 1.5 megohms; transconductance, 650 μ mhos. This is a DISCONTINUED type listed for reference only.

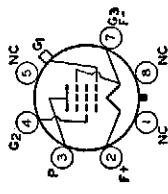

1E7GT

TWIN POWER PENTODE

Glass octal type used in push-pull output stage of battery-operated receivers. Outline 14C, OUTLINES SECTION. Tube requires octal socket. Filament volts (dc), 2.0; amperes, 0.24. Typical operation as push-pull class A₁ amplifier: plate and grid-No.2 volts, 185 max; grid-No.1 volts, -7.5; plate ma., 10.5; grid-No.2 ma., 3.5; output watts, 0.375. This is a DISCONTINUED type listed for reference only.

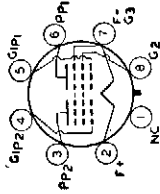

1E8

PENTAGRID CONVERTER

Subminiature type used in small, compact, battery-operated receivers for the standard AM broadcast band. Maximum dimensions: over-all length, 1.75 inches; seated height, 1.5 inches; diameter, 0.4 inch. Tube requires subminiature eight-contact socket. Filament volts (dc), 1.25; amperes, 0.04. Typical operation as converter: plate volts and grids-No.2-and-No.4 supply volts, 67.5 max; grids-No.2-and-No.4 resistor, 20000 ohms; grid-No.3 volts, 0; grid-No.1 resistor, 0.1 megohm; plate resistance (approx.), 0.4 megohm; conversion transconductance, 150 μ mhos; total cathode ma., 2.5 (4 max); plate ma., 1; grids-No.2-and-No.4 ma., 1.5; grid-No.1 μ a., 70. This is a DISCONTINUED type listed for reference only.

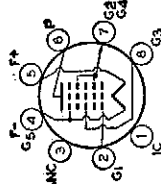

1F4

POWER PENTODE

Glass type used in output stage of battery-operated receivers. Outline 27, OUTLINES SECTION. Tube requires five-contact socket. Filament volts (dc), 2.0; amperes, 0.12. Type 1F4 is similar electrically to type 1F5-G. Type 1F4 is a DISCONTINUED type listed for reference only.

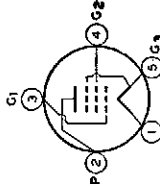

1F5G

POWER PENTODE

Glass octal type used in output stage of battery-operated receivers. Outline 26, OUTLINES SECTION. Tube requires octal socket. Filament volts (dc), 2.0; amperes, 0.12. Typical operation as class A₁ amplifier: plate and grid-No.2 (screen-grid) volts, 135 (180 max); grid-No.1 volts, -4.5; plate ma., 8; grid-No.2 ma., 2.4; cathode resistor, 432 ohms; output watts, 0.31. This is a DISCONTINUED type listed for reference only.

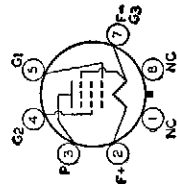

**TWIN DIODE—
SHARP-CUTOFF PENTODE**

Glass type used as combined detector, amplifier, and avc tube in battery-operated receivers. Outline 23, OUTLINES SECTION. Tube requires six-contact socket. Filament volts (dc), 2.0; amperes, 0.06. Typical operation of pentode unit as class A₁ amplifier: plate volts, 180 max; grid-No.2 (screen-grid) volts, 67.5 max; grid-No.1 volts, -1.5; plate ma., 2.2; grid-No.2 ma., 0.7. This is a DISCONTINUED type listed for reference only.

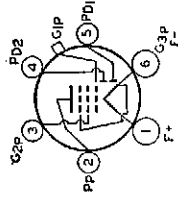

1F6

**TWIN DIODE—
SHARP-CUTOFF PENTODE**

Glass octal type used as combined detector, amplifier, and avc tube in battery-operated receivers. Outline 23, OUTLINES SECTION. Tube requires octal socket. Filament volts (dc), 2.0; amperes, 0.06. Similar electrically to type 1F6 except for interelectrode capacitances. Type 1F7G is a DISCONTINUED type listed for reference only.

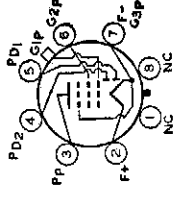

1F7G

**1G3GT/
1B3GT**

HALF-WAVE VACUUM RECTIFIER

Glass octal type used in high-voltage, low-current applications such as the rectifier in a high-voltage, rf-operated power supply or as a rectifier of high-voltage pulses produced in television scanning systems. Outline 15B, OUTLINES SECTION. This type may be supplied with pins 1, 4, and/or 6 omitted. Tube requires octal socket and may be mounted in any position. Except for physical dimensions, this type is identical with glass octal type 1B3-GT.

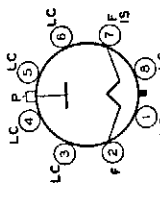

MEDIUM-MU TRIODE

Glass octal type used in battery-operated receivers as detector or voltage amplifier. Outline 14C, OUTLINES SECTION. Tube requires octal socket. Filament volts (dc), 1.4; amperes, 0.05. Typical operation and characteristics as class A₁ amplifier: plate volts, 90 (100 max); grid volts, -6; plate ma., 2.3; plate resistance, 10700 ohms; amplification factor, 8.8; transconductance, 825 μ mhos. This is a DISCONTINUED type listed for reference only.

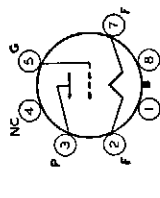

1G4GT

POWER PENTODE

Glass octal type used in output stage of battery-operated receivers. Outline 26, OUTLINES SECTION. Tube requires octal socket. Filament volts (dc), 2.0; amperes, 0.12. Typical operation as class A₁ amplifier: plate and grid-No.2 (screen-grid) volts, 135 max; grid-No.1 volts, -13.5; plate ma., 9.7; output watts, 0.55. This is a DISCONTINUED type listed for reference only.

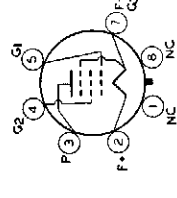

1G5G

HIGH-MU TWIN POWER TRIODE

Glass octal type used in output stage of battery-operated receivers. Outline 14C, OUTLINES SECTION. Tube requires octal socket. Filament volts (dc), 1.4; amperes, 0.1. Typical operation as class B amplifier: plate volts, 90 (110 max); dc grid volts, 0; peak at grid-to-grid volts, 48; effective grid-circuit impedance per unit, 2650 ohms; plate ma. (zero signal), 2; (maximum signal), 11; peak grid ma. per unit, 6; output watts (approx.), 0.35. This is a DISCONTINUED type listed for reference only.

1G6GT

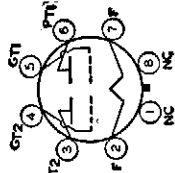

MEDIUM-MU TRIODE

Glass octal type used as detector or voltage amplifier in battery-operated receivers. Outline 22, OUTLINES SECTION. Tube requires octal socket. Filament volts (dc), 2.0; amperes, 0.06. Typical operation as class A₁ amplifier: plate volts, 180 max; grid volts, -13.5; amplification factor, 9.3; plate resistance, 10300 ohms; trans-conductance, 900 μ mhos; plate ma., 3.1. This is a DISCONTINUED type listed for reference only.

1H4G

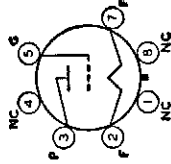

DIODE—HIGH-MU TRIODE

Glass octal type used as combined detector and amplifier in battery-operated receivers. Outline 15A, OUTLINES SECTION. Tube requires octal socket. Filament volts (dc), 1.4; amperes, 0.06. Characteristics of triode unit as class A₁ amplifier: plate volts, 90 (110 max); grid volts, 2.0; plate ma., 0.15; plate resistance (approx.), 24000 ohms; amplification factor, 65; trans-conductance, 275 μ mhos. Diode is located at negative end of filament. This type is used principally for renewal purposes.

1H5GT

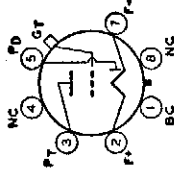

TWIN DIODE—MEDIUM-MU TRIODE

Glass octal type used as combined detector, amplifier, and a v_c tube in battery-operated receivers. Outline 22, OUTLINES SECTION. Tube requires octal socket. Filament volts (dc) 2.0; amperes, 0.06. Type 1H6-G is similar electrically to type 1B6/25S. Type 1H6G is a DISCONTINUED type listed for reference only.

1H6G

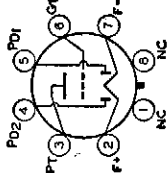

HALF-WAVE VACUUM RECTIFIER

Glass octal type used as a rectifier of high-voltage pulses produced in the scanning systems of black-and-white television receivers. Outline 15D, OUTLINES SECTION. Except for physical dimensions, this type is identical with glass octal type 1K3.

1J3

POWER PENTODE

Glass octal type used in output stage of battery-operated receivers. Outline 26, OUTLINES SECTION. Tube requires octal socket. Filament volts (dc), 2.0; amperes, 0.12. Typical operation as class A₁ amplifier: plate and grid-No.2 (screen-grid) volts, 135 max; grid-No.1 volts, -16.5; plate ma., 7.0; grid-No.2 ma., 2.0; plate resistance, 10500 ohms; load resistance, 13500 ohms; output watts, 0.45. This is a DISCONTINUED type listed for reference only.

1J5G

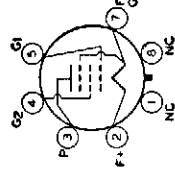

HIGH-MU TWIN POWER TRIODE

Glass octal types used in output stage of battery-operated receivers. Type 1J6-G, Outline 22; type 1J6GT, Outline 14E, OUTLINES SECTION. Tubes require octal socket. Filament volts (dc), 2.0; amperes, 0.24. Typical operation as class B power amplifier: plate volts, 135 max; peak plate ma. per plate, 50 max; grid volts, 0; zero-signal plate ma. per plate, 5; effective plate-to-plate load resistance, 10000 ohms; average input watts, 0.17; output watts, 2.1. These are DISCONTINUED types listed for reference only.

1J6G
1J6GT

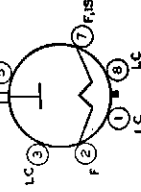

HALF-WAVE VACUUM RECTIFIER

Glass octal type used as a rectifier of high-voltage pulses produced in the scanning systems of black-and-white television receivers. Type 1K3 requires an octal socket and may be mounted in any position. Plate connection is cap at top of bulb. Socket terminals 1, 3, 4, 5, 6, and 8 may be connected to socket terminal 7 or to a corona shield which is connected to socket terminal 7. Socket terminals 4 and 6 may be used as tie points for components at or near filament potential. Outline 15B, OUTLINES SECTION. For high-voltage considerations, see type 1B3-GT.

1K3

FILAMENT VOLTAGE (AC/DC).....	1.25*	volts
FILAMENT CURRENT.....	0.2	amperes
DIRECT INTERELECTRODE CAPACITANCE (Approx.): Plate to Filament and Internal Shield.....	1.6	pf
* Under no circumstances should the filament voltage be less than 1.05 volts or greater than 1.45 volts.		

PULSED RECTIFIER

For operation in a 525-line, 50-frame system

Maximum Ratings, (Design-Maximum Values):		
PEAK INVERSE PLATE VOLTAGE*	26000	max
PEAK PLATE CURRENT.....	50	max
AVERAGE PLATE CURRENT.....	0.5	max
Characteristics, Instantaneous Value:		
Tube Voltage Drop for plate current of 7 ma.....	225	volts

Characteristics, Instantaneous Value:

*The duration of the voltage pulse must not exceed 15 per cent of one horizontal scanning cycle. In a 525-line, 50-frame system, 15 per cent of one horizontal scanning cycle is 10 microseconds.
* The dc component must not exceed 22000 volts.

PENTAGRID CONVERTER

Miniature type used in low-drain battery-operated receivers. Outline 7B, OUTLINES SECTION. Tube requires miniature seven-contact socket and may be mounted in any position. Filament volts (dc), 1.4; amperes, 0.05. Typical operation as converter: plate and grid-No.2 volts, 90 (110 max); grids-No.3-and-No.5 supply volts, 110 max; grid-No.4 volts, 0; grid-No.1 volts, 45 (65 max); grid-No.4 volts, 0; grid-No.1 resistor, 0.5 megohm; plate resistance (approx.), 0.65 megohm; plate ma., 0.5; grids-No.3-and-No.5 ma., 0.6; grid-No.2 ma., 1.2; grid-No.1 ma., 0.085; total cathode ma., 2.35 (4 max); conversion transconductance, 300 μ mhos. This type is used principally for renewal purposes.

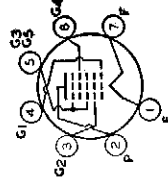

1L6

POWER PENTODE

Glass lock-in type used in output stage of battery-operated receivers. Outline 19A, OUTLINES SECTION. Tube requires lock-in socket. Filament volts (dc), 1.4; amperes, 0.05. For electrical characteristics and typical operation, refer to glass-octal type 1A5-GT. Type 1LA4 is a DISCONTINUED type listed for reference only.

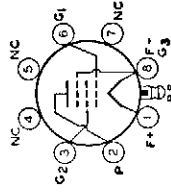

1LA4

11A6

PENTAGRID CONVERTER

Glass lock-in type used in battery-operated receivers. Outline 18A, OUTLINES SECTION. Tube requires lock-in socket. Filament volts (dc), 1.4; ampere, 0.05. Typical operation as converter is the same as for type 1A7-GT except that grid-No.2 volts is 65 maz, total cathode ma. is 4.0 maz, plate resistance is 0.75 megohm, and conversion transconductance for a grid-No.4 bias of -3 volts is 10 amhos. This type is used principally for renewal purposes.

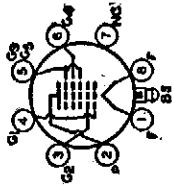

11B4

POWER PENTODE

Glass lock-in type used in output stage of battery-operated receivers. Outline 19A, OUTLINES SECTION. Tube requires lock-in socket. Filament volts (dc), 1.4; ampere, 0.05. For electrical characteristics, refer to pentode unit of glass-occal type 1D8-GT. Type 11B4 is used principally for renewal purposes.

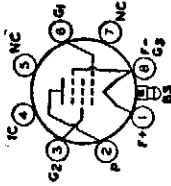

11C5

SHARP-CUTOFF PENTODE

Glass lock-in type used as rf or if amplifier in battery-operated receivers. Outline 18A, OUTLINES SECTION. Tube requires lock-in socket. Filament volts (dc), 1.4; ampere, 0.05. Typical operation as class A1 amplifier: plate volts, 90 (110 maz); grid-No.2 (screen-grid) volts, 45 maz; grid-No.1 volts, 0; plate resistance (approx.), greater than 1 megohm; transconductance, 775 amhos; plate ma., 1.15; grid-No.2 ma., 0.3. This is a DISCONTINUED type listed for reference only.

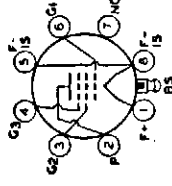

11C6

PENTAGRID CONVERTER

Glass lock-in type used in battery-operated receivers. Outline 18A, OUTLINES SECTION. Tube requires lock-in socket. Filament volts (dc), 1.4; ampere, 0.05. Typical operation as converter: plate volts, 90 (110 maz); grids-No.3 and -No.5 volts, 35 (45 maz); grid-No.2 volts, 45; grid-No.1 volts, 0; plate resistance, 0.55 megohm; plate ma., 0.75; grids-No.3 and -No.5 ma., 0.70; grid-No.2 ma., 1.4; total cathode ma., 2.9; conversion transconductance (zero bias), 275 amhos. This type is used principally for renewal purposes.

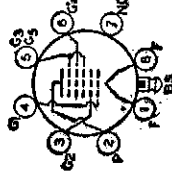

11D5

DIODE—SHARP-CUTOFF PENTODE

Glass lock-in type used as combined detector and af voltage amplifier in battery-operated receivers. Outline 18A, OUTLINES SECTION. Tube requires lock-in socket. Filament volts (dc), 1.4; ampere, 0.05. Characteristics of pentode unit: plate volts, 90 (110 maz); grid-No.2 volts, 45; grid-No.1 volts, 0; plate ma., 0.6; grid-No.2 ma., 0.1; plate resistance, 0.75 megohm; transconductance, 575 amhos. This is a DISCONTINUED type listed for reference only.

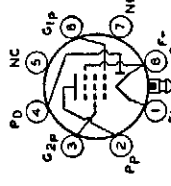

11E3

MEDIUM-MU TRIODE

Glass lock-in type used as detector or voltage amplifier in battery-operated receivers. Outline 18A, OUTLINES SECTION. Tube requires lock-in socket. Filament volts (dc), 1.4; ampere, 0.05. Typical operation as class A1 amplifier: plate volts, 90 (110 maz); grid volts, -8; plate ma., 1.4; plate resistance, 19000 ohms; transconductance, 760 amhos; amplification factor, 14.5. This type is used principally for renewal purposes.

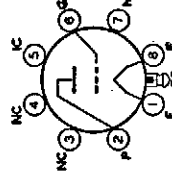

11G5

REMOTE-CUTOFF PENTODE

Lock-in type used as rf or if amplifier in battery-operated receivers. Outline 19A, OUTLINES SECTION. Tube requires lock-in socket. Filament volts (dc), 1.4; ampere, 0.05. Typical operation as class A1 amplifier: plate volts, 90 (110 maz); grid-No.2 volts, 45 (110 maz); grid-No.1 volts, 0; plate resistance (approx.), greater than 1 megohm; transconductance, 800 amhos; plate ma., 1.7; grid-No.2 ma., 0.4. This type is used principally for renewal purposes.

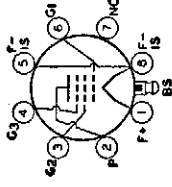

11H4

DIODE—HIGH-MU TRIODE

Glass lock-in type used as combined detector and amplifier in battery-operated receivers. Outline 18A, OUTLINES SECTION. Tube requires lock-in socket. Filament volts (dc), 1.4; ampere, 0.05. For electrical characteristics, refer to glass-occal type 1H6GT. Type 11H4 is used principally for renewal purposes.

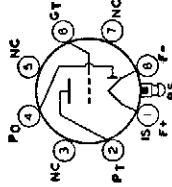

11N5

SHARP-CUTOFF PENTODE

Glass lock-in type used as rf or if amplifier in battery-operated receivers. Outline 18A, OUTLINES SECTION. Tube requires lock-in socket. Filament volts (dc), 1.4; ampere, 0.05. Typical operation as class A1 amplifier: plate and grid-No.2 (screen-grid) volts, 90 (110 maz); grid-No.1 volts, 0; plate ma., 1.6; grid-No.2 ma., 0.35; plate resistance (approx.), 1.1 megohms; transconductance, 800 amhos. This type is used principally for renewal purposes.

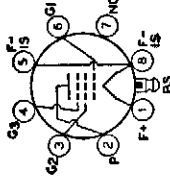

1N2A

HALF-WAVE VACUUM RECTIFIER

Glass octal type used as high-voltage rectifier in television receivers. Maximum over-all length, 3.9/16 inches; maximum seated length, 3 inches; maximum diameter, 1-9/16 inches. Tube requires octal socket and may be operated in any position. For installation and application considerations, refer to type 1B3GT.

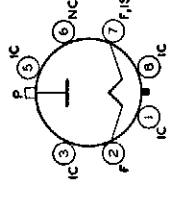

FILAMENT VOLTAGE (AC)	1.25*	volts
FILAMENT CURRENT	0.2	ampere
DIRECT INTERELECTRODE CAPACITANCE: Plate to Filament and Internal Shield	1.4	pf

PULSED RECTIFIER

For operation in a 525-line, 50-frame system

Maximum Ratings, (Design-Maximum Values):		
PEAK INVERSE PLATE VOLTAGE*	28000	maz
PEAK PLATE CURRENT	50	ma
AVERAGE PLATE CURRENT	0.5	maz

Characteristics, Instantaneous Values:

Tube Voltage Drop for plate current of 7 ma	100	volts
* Under no circumstances should the filament voltage be less than 1.05 volts or greater than 1.45 volts.		
* The duration of the voltage pulse must not exceed 15 per cent of one horizontal scanning cycle. In a 525-line, 30-frame system, 15 per cent of one horizontal scanning cycle is 10 microseconds.		
* The dc component must not exceed 24000 volts.		

SHARP-CUTOFF PENTODE

Glass octal type used as rf or if amplifier in battery-operated receivers. Outline 15A, OUTLINES SECTION. Tube requires octal socket. Filament volts (dc), 1.4; amperes, 0.05. Characteristics as class A₁ amplifier: plate and grid-No.2 volts, 90 (110 *max*); grid-No.1 volts, 0; plate resistance (approx.), 1.5 megohms; transconductance, 750 μ mhos; plate ma., 1.2; grid-No.2 ma., 0.3. This type is used principally for renewal purposes.

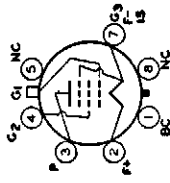

1N5GT

DIODE—POWER PENTODE

Glass octal type used as combined detector and power output tube in battery-operated receivers. Maximum over-all length, 4 inches; maximum diameter, 1-3/16 inches. Filament volts (dc), 1.4; amperes, 0.05. Typical operation of pentode unit as class A₁ amplifier: plate and grid-No.2 (screen-grid) volts, 90 (110 *max*); grid-No.1 volts, -4.5; plate ma., 3.1; grid-No.2 ma. (zero-signal), 0.6; plate resistance (approx.), 0.8 megohm; transconductance, 800 μ mhos; load resistance, 25000 ohms; output watts, 0.1. This is a DISCONTINUED type listed for reference only.

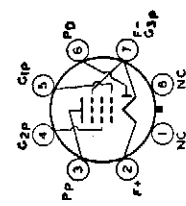

1N6G

REMOTE-CUTOFF PENTODE

Glass octal type used as rf or if amplifier in battery-operated receivers. Outline 15A, OUTLINES SECTION. Tube requires octal socket. Filament volts (dc), 1.4; amperes, 0.05. Typical operation as class A₁ amplifier: plate volts, 90 (110 *max*); grid-No.2 (screen-grid) volts, 90 (110 *max*); grid-No.1 volts, 0; plate resistance (approx.), 0.8 megohm; transconductance, 750 μ mhos; plate ma., 2.3; grid-No.2 ma., 0.7. This is a DISCONTINUED type listed for reference only.



1P5GT

BEAM POWER TUBE

Glass octal type used in the output stage of battery-operated receivers. Outline 14C, OUTLINES SECTION. Tube requires octal socket. Filament volts (dc), 1.4; amperes, 0.1. For electrical characteristics and ratings, refer to type 8Q5-GT with parallel filament arrangement. Type 1Q5-GT is a DISCONTINUED type for reference only.

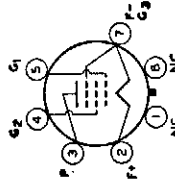

1Q5GT

PENTAGRID CONVERTER

Miniature type used in lightweight, portable, compact, battery-operated receivers. Outline 7B, OUTLINES SECTION. Tube requires miniature seven-contact socket. Characteristics as converter with separate excitation: plate volts, 67.5 (90 *max*); grids-No.2 and No.4 volts, 67.5 *max*; grid-No.3 volts, 0; rns grid-No.1 volts, 25; grid-No.1 resistor, 0.1 megohm; plate resistance (approx.), 0.4 megohm; conversion transconductance, 260 μ mhos; plate ma., 1.4; grids-No.2 and No.4 ma., 3.5; grid-No.1 μ a, 250; total cathode ma., 5.2. This type is used principally for renewal purposes.

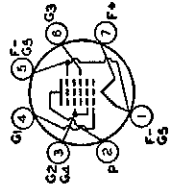

1R5

POWER PENTODE

Miniature type used in output stage of lightweight, compact, portable, battery-operated equipment. Types 1S4 and 3S4 are identical except for filament arrangement. Outline 7B, OUTLINES SECTION. Type 1S4 requires miniature seven-contact socket and may be mounted in any position. For ratings and typical operation, refer to type 3S4 with parallel filament arrangement. Filament volts (dc), 1.4; amperes, 0.1. This type is used principally for renewal purposes.

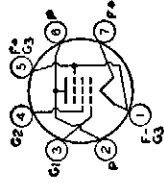

1S4

DIODE—SHARP-CUTOFF PENTODE

Miniature type used in lightweight, portable, compact, battery-operated receivers as combined detector and at voltage amplifier. Outline 7B, OUTLINES SECTION. Tube requires miniature seven-contact socket. Filament volts (dc), 1.4; amperes, 0.05. For electrical characteristics, refer to type 1U5. Type 1S5 is used principally for renewal purposes.

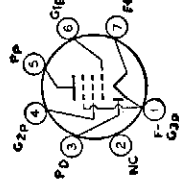

1S5

REMOTE-CUTOFF PENTODE

Miniature type used in lightweight, portable, compact, battery-operated receivers as rf or if amplifier. Outline 7B, OUTLINES SECTION. Tube requires miniature seven-contact socket. Filament volts (dc), 1.4; amperes, 0.05. Characteristics as class A₁ amplifier: plate and grid-No.2 volts, 67.5 (90 *max*); grid-No.1 volts, 0; plate resistance (approx.), 0.25 megohm; transconductance, 875 μ mhos; plate ma., 3.4; grid-No.2 ma., 1.5. This type is used principally for renewal purposes.

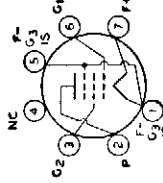

1T4

BEAM POWER TUBE

Glass octal type used in output stage of battery-operated receivers. Outline 14C, OUTLINES SECTION. Tube requires octal socket. Filament volts (dc), 1.4; amperes, 0.05. Typical operation as class A₁ amplifier: plate and grid-No.2 volts, 90 (110 *max*); grid-No.1 volts, -6; peak at grid-No.1 volts, 6; plate ma., 6.5; grid-No.2 ma. (zero-signal), 0.8; grid-No.2 ma. (maximum signal), 1.5; plate resistance, 0.25 megohm; transconductance, 1150 μ mhos; load resistance, 14000 ohms; total harmonic distortion, 7.5 per cent; output watts, 0.17. This is a DISCONTINUED type listed for reference only.

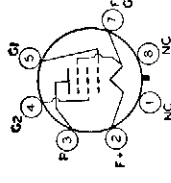

1T5GT

DIODE—SHARP-CUTOFF PENTODE

Subminiature type used as combined detector and audio amplifier in small, compact, battery-operated receivers for the standard AM broadcast band. Maximum dimensions: over-all length, 1.75 inches; seated height, 1.5 inches; diameter, 0.4 inch. Tube requires subminiature eight-contact socket. Filament volts (dc), 1.25; amperes, 0.04. Filament voltage should never exceed 1.6 volts. Typical operation of pentode as class A₁ amplifier: plate and grid-No.2 volts, 67.5 *max*; grid-No.1 volts, 0; plate resistance (approx.), 0.4 megohm; transconductance, 600 μ mhos; plate ma., 1.6; grid-No.2 ma., 0.4; total cathode ma., 2.0 *max*. Maximum diode plate ma., 0.25. This is a DISCONTINUED type listed for reference only.

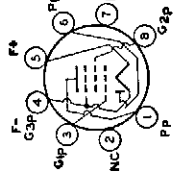

1T6

ohms; power output, 3.5 watts. Typical operation as push-pull class AB₁ amplifier (values are for two tubes): plate supply volts, 300; cathode-bias resistor, 780 ohms; peak at grid-to-grid volts, 156; zero-signal plate ma., 80; maximum-signal plate ma., 100; effective load resistance (plate-to-plate), 5000 ohms; power output, 10 watts. This type is used principally for renewal purposes.

POWER PENTODE

Glass type used in output stage of ac-operated receivers. Outline 27, OUTLINES SECTION. Tube requires six-contact socket. Except for its heater rating (2.5 volts ac/dc; 1.75 amperes), the 2A5 has electrical characteristics identical with type 6F6. Type 2A5 is a DISCONTINUED type listed for reference only.

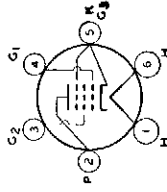

2A5

TWIN DIODE—HIGH-MU TRIODE

Glass type used in ac-operated receivers chiefly as a combined detector, amplifier, and a.v.c. tube. Outline 24B, OUTLINES SECTION. Tube requires six-contact socket. Except for its heater rating (2.5 volts ac/dc; 0.8 ampere), and within its 250-volt maximum plate rating, the 2A6 has electrical characteristics identical with type 6SQ7. Type 2A6 is a DISCONTINUED type listed for reference only.

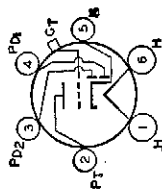

2A6

PENTAGRID CONVERTER

Glass type used in ac-operated receivers. Outline 24B, OUTLINES SECTION. Tube requires small seven-contact (0.75-inch, pin-circle diameter) socket. Except for its heater rating (2.5 volts ac/dc; 0.8 ampere) and its interelectrode capacitances, the 2A7 has electrical characteristics identical with type 6A8. Complete shielding of this tube is generally necessary. Type 2A7 is a DISCONTINUED type listed for reference only.

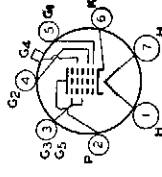

2A7

MEDIUM-MU TRIODE

Miniature types used as local oscillator in uhf television receivers employing series-connected heater strings. Outline 7A, OUTLINES SECTION. Heater volts (ac/dc), 2.35; amperes,

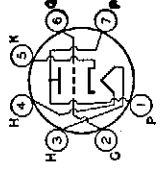

2AF4A
2AF4B

Related types:
3AF4A, 6AF4A

0.6; warm-up time (average), 11 seconds. Type 2AF4-B only, maximum rating (design maximum), peak heater-cathode volts, 180 max. When the heater is positive with respect to the cathode, the dc component of the heater-cathode voltage must not exceed 100 volts. Typical operation of 2AF4-B as oscillator at 1000 Mc: plate ma., 17.5; grid μ a (approx.), 700. Except for heater ratings noted, these types are identical with miniature type 6AF4-A. Type 2AF4-A is a DISCONTINUED type listed for reference only.

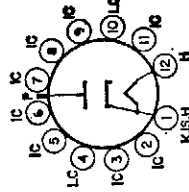

2AH2

HALF-WAVE VACUUM RECTIFIER

Duodecar type used to supply high voltage to the anode of picture tubes in television receivers. Outline 16A, OUTLINES SECTION. Tube requires 12-contact socket and may be

mounted in any position. Socket terminals 2, 3, 5, 6, 7, 8, 9, and 11 should not be used as tie points; terminals 4 and 10 may be used as tie points for components at or near cathode potential. For high-voltage and X-ray safety considerations, refer to type 1B3-GT. Heater volts (ac/dc), 2.5; amperes, 0.3.

PULSED RECTIFIER
For operation in a 525-line, 30-frame system

Maximum Ratings, (Design-Maximum Values):

PEAK INVERSE PLATE VOLTAGE*	80000 ^{max}	volts
PEAK PLATE CURRENT	80	ma
AVERAGE PLATE CURRENT	1.5	ma

Characteristics, Instantaneous Value:

Tube Voltage Drop for plate current of 7 ma. 100 volts
*The duration of the voltage pulse must not exceed 16 per cent of one horizontal scanning cycle. In a 525-line, 30-frame system, 15 per cent of one horizontal scanning cycle is 10 microseconds.
*The dc component must not exceed 24000 volts.

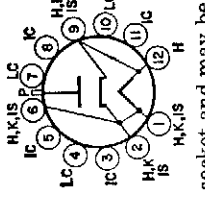

HALF-WAVE VACUUM RECTIFIER

Duodecar type used to supply high voltage to the anode of picture tubes in television receivers. Outline 16B, OUTLINES SECTION. Tube requires duodecar twelve-contact

2AS2

socket and may be mounted in any position. Socket terminals 4, 7, and 10 may be used as tie points for components at or near heater potential. For high-voltage and X-ray safety considerations, refer to type 1B3-GT. Heater volts (ac/dc), 2.5; amperes, 0.33.

PULSED RECTIFIER

For operation in a 525-line, 30-frame system

Maximum Ratings, (Design-Maximum Values):

PEAK INVERSE PLATE VOLTAGE*	30000 ^{max}	volts
PEAK PLATE CURRENT	80	ma
AVERAGE PLATE CURRENT	1.5	ma

Characteristics, Instantaneous Value:

Tube Voltage Drop for plate current of 7 ma. 100 volts
*The duration of the voltage pulse must not exceed 15 per cent of one horizontal scanning cycle. In a 525-line, 30-frame system, 15 per cent of one horizontal scanning cycle is 10 microseconds.
*The dc component must not exceed 24000 volts.

TWIN DIODE—REMOTE-CUTOFF PENTODE

Glass type used as combined detector, a.v.c. tube, and amplifier. Outline 24B, OUTLINES SECTION. Tube requires small seven-contact (0.75-inch, pin-circle diameter) socket. Except for its heater rating (2.5 volts ac/dc; 0.8 ampere) and its interelectrode capacitances, the 2B7 has electrical characteristics identical with type 6B8-G. Type 2B7 is a DISCONTINUED type listed for reference only.

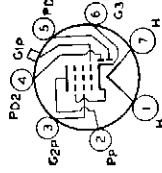

2B7

MEDIUM-MU TRIODE

Miniature types used as rf amplifier in vhf television tuners employing series-connected heater strings. Outline 7B, OUTLINES SECTION. Heater volts (ac/dc), 2BN4, 2.3; 2BN4-A, 2.35; amperes, 0.6; warm-up time (average), 11 seconds. Except for heater rating, these types are identical with miniature types 6BN4 and 6BNA4, respectively. Type 2BN4 is a DISCONTINUED type listed for reference only. Type 2BN4-A is used principally for renewal purposes.

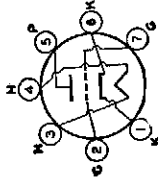

2BN4

2BN4A

Related types:
3BNA4, 6BNA4

HIGH-MU TRIODE

Nuvistor type used as a grounded-cathode, neutralized rf amplifier in vhf tuners of television and FM receivers employing series-connected heater strings. Outline 7B, OUTLINES SECTION. Heater volts (ac/dc), 2.1; amperes, 0.45; warm-up time (average), 8 seconds. Except for heater ratings, this type is identical with nuvistor type 6CW4.

2CW4

Related types:
6CW4, 19CW4

type is identical with nuvistor type 6CW4.

SHARP-CUTOFF TETRODE

Miniature type used as rf amplifier in vhf tuners of television receivers employing series-connected heater strings. Outline 7B, OUTLINES SECTION. Heater volts (ac/dc), 2.4; amperes, 0.6; warm-up time (average), 11 seconds. Except for heater ratings, this type is identical with miniature type 6CY5.

2CY5

Related types:
3CY5, 4CY5, 6CY5

peres, 0.6; warm-up time (average), 11 seconds. Except for heater ratings, this type is identical with miniature type 6CY5.

HIGH-MU TRIODE

Nuvistor type used as grounded-cathode, neutralized rf amplifier in vhf tuners of television and FM receivers employing series-connected heater strings. Because of its cutoff characteristics, the 2DS4 is used in circuits to reduce cross-modulation distortion. Outline 1, OUTLINES SECTION. Heater volts (ac/dc), 2.1; amperes, 0.45; warm-up time (average), 8 seconds. Except for heater ratings, this type is identical with nuvistor type 6DS4.

2DS4

Related types:
6DS4

0.45; warm-up time (average), 8 seconds. Except for heater ratings, this type is identical with nuvistor type 6DS4.

MEDIUM-MU TRIODE

Nuvistor type used at frequencies up to 1000 megacycles in uhf oscillator stages of television receivers employing series-connected heater strings. Outline 1, OUTLINES SECTION. Heater volts (ac/dc), 2.1; amperes, 0.45; warm-up time (average), 8 seconds. Except for heater ratings, this type is identical with nuvistor type 6DV4.

2DV4

Related types:
6DV4

MEDIUM-MU TRIODE

Miniature type used as a local-oscillator tube in uhf television receivers covering the frequency range from 470 to 890 megacycles and employing series-connected heater strings. Outline 7A, OUTLINES SECTION. Heater volts (ac/dc), 2.35; amperes, 0.6; warm-up time (average), 11 seconds. Peak heater-cathode volts, 180 max (the dc component must not exceed 100 volts when heater is positive with respect to cathode). Except for heater and heater-cathode ratings, this type is identical with miniature type 6DZ4.

2DZ4

Related types:
3DZ4, 6DZ4

Outline 7A, OUTLINES SECTION. Heater volts (ac/dc), 2.35; amperes, 0.6; warm-up time (average), 11 seconds. Peak heater-cathode volts, 180 max (the dc component must not exceed 100 volts when heater is positive with respect to cathode). Except for heater and heater-cathode ratings, this type is identical with miniature type 6DZ4.

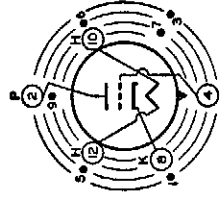

INDEX - LARGE LUG
● - PIN CUT OFF

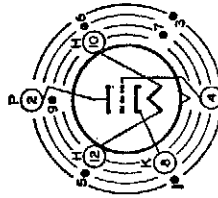
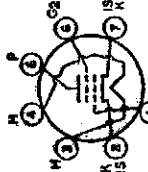

INDEX - LARGE LUG
● - SHORT PIN; IC - DO NOT USE

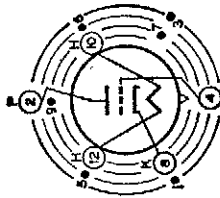

INDEX - LARGE LUG
● - SHORT PIN; IC - DO NOT USE

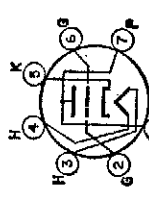

ELECTRON-RAY TUBE

Glass type with triode unit used to indicate visually by means of a fluorescent target the effects of a change in a controlling voltage. It is used as a convenient means of indicating accurate radio receiver tuning. Maximum dimensions: overall length, 4-3/16 inches; seated height, 3-9/16 inches; diameter, 1-9/16 inches. Tuberequirements: contact socket. Except for its heater rating (2.5 volts ac/dc; 0.8 ampere), the 2E5 has electrical characteristics identical with type 6E5. Type 2E5 is a DISCONTINUED type listed for reference only.

2E5

Related type:
6E5

TWIN DIODE

Miniature type used as a horizontal phase detector in television receivers. Outline 7B, OUTLINES SECTION. Tube requires miniature seven-contact socket and may be mounted in any position. Heater volts (ac/dc), 2.1; amperes, 0.45; warm-up time (average), 11 seconds. Maximum ratings (design maximum) as half-wave rectifier: dc output max. per plate, 5 max; peak heater-cathode volts, 200 max. When the heater is positive with respect to cathode, the dc component of the heater-cathode voltage must not exceed 100 volts. Type 2EN5 is used principally for renewal purposes.

2EN5

heater is positive with respect to cathode, the dc component of the heater-cathode voltage must not exceed 100 volts. Type 2EN5 is used principally for renewal purposes.

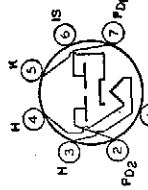

SHARP-CUTOFF TRIODE

Miniature type with frame grid used in vhf tuners of television receivers. Outline 7B, OUTLINES SECTION. Heater volts (ac/dc), 2.3; amperes, 0.6. Except for heater ratings, this type is identical with miniature type 6ER5.

2ER5

Related types:
3ER5, 6ER5

SHARP-CUTOFF TRIODE

Miniature type used as an rf amplifier in vhf tuners of television receivers employing series-connected heater strings. Outline 7B, OUTLINES SECTION. Heater volts (ac/dc), 2.35; amperes, 0.6; warm-up time (average), 11 seconds. Except for heater ratings, this type is identical with miniature type 6FH5.

2FH5

Related types:
3FH5, 6FH5

BEAM HEXODE

Miniature type used as rf-amplifier tube in vhf television receivers employing series-connected heater strings. Outline 7B, OUTLINES SECTION. Heater volts (ac/dc), 2.4; amperes, 0.6; warm-up time (average), 11 seconds. Except for heater ratings, this type is identical with miniature type 6FS5.

2FS5

Related type:
6FS5

HIGH-MU TRIODE

Miniature type with frame grid used as grounded-cathode rf-amplifier tube in vhf tuners of television receivers employing series-connected heater strings. Outline 7B, OUTLINES SECTION. Heater volts (ac/dc), 2.3; amperes, 0.6; warm-up time (average), 11 seconds. Except for heater ratings, this type is identical with miniature type 6GK5.

2GK5

Related types:
3GK5, 6GK5

Outline 7B, OUTLINES SECTION. Heater volts (ac/dc), 2.3; amperes, 0.6; warm-up time (average), 11 seconds. Except for heater ratings, this type is identical with miniature type 6GK5.

3A2

HALF-WAVE VACUUM RECTIFIER

Miniature type used as rectifier of high-voltage pulses produced in scanning systems of color television receivers. Outline 9A, OUTLINES SECTION. Tube requires miniature 9-contact socket and may be mounted in any position. Socket terminals 3 and 7 may be connected to the heater. Heater volts (ac), 3.15; amperes, 0.22. Maximum ratings as pulsed rectifier in 626-line, 30-frame system: peak inverse plate volts, 18000 max; average plate ma., 1.5 max. For high-voltage considerations, see type 1B3-GT. Type 3A2 is used principally for renewal purposes.

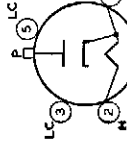
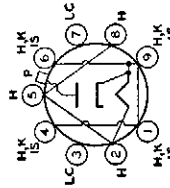

HALF-WAVE VACUUM RECTIFIER

Glass octal type used as rectifier of high-voltage pulses produced in the scanning systems of color television receivers. Outline 15D, OUTLINES SECTION. Tube requires octal socket and may be mounted in any position. Socket terminals 1, 3, 4, 5, 6, and 8 may be connected to socket terminal 7. Socket terminals 4 and 6 may be used as tie points for components at or near heater potential. For high-voltage considerations, see type 1B3-GT.

HEATER VOLTAGE (AC).....	8.15*	volts
HEATER CURRENT.....	0.22	ampere
DIRECT INVERSE-TRIODE CAPACITANCE (Approx.):		
Plate to Heater, Cathode, and Internal Shield.....	1.5	pf

* Under no circumstances should the heater voltage be less than 2.65 volts or greater than 3.65 volts.

PULSED RECTIFIER

For operation in a 525-line, 30-frame system

Maximum Ratings, (Design-Maximum Values):		
PEAK INVERSE PLATE VOLTAGE*.....	80000 max	volts
PEAK PLATE CURRENT.....	88 max	ma
AVERAGE PLATE CURRENT.....	1.7 max	ma

* The duration of the voltage pulse must not exceed 15 per cent of one horizontal scanning cycle. In a 525-line, 30-frame system, 15 per cent of one horizontal scanning cycle is 10 microseconds.

DIODE—TRIODE—PENTODE

Glass octal type used as combined detector, af amplifier, and rf amplifier in battery-operated receivers. Maximum over-all length, 3-7/16 inches; maximum diameter, 1-5/16 inches. Filament volts, 1.4 (parallel), 2.8 (series); amperes, 0.1 (parallel), 0.05 (series). Typical operation as class A amplifier: triode unit—plate volts, 90 (110 max); grid volts, 0; amplification factor, 65; plate resistance, 0.2 megohm; transconductance, 825 μ mhos; plate ma., 0.2; pentode unit—plate and grid-No.2 volts, 90 (110 max); grid-No.1 volts, 0; plate resistance, 0.8 megohm; transconductance, 750 μ mhos; plate ma., 1.5; grid-No.2 ma., 0.5. This is a DISCONTINUED type listed for reference only.

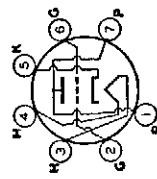
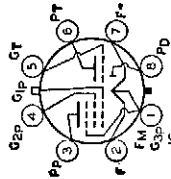

MEDIUM-MU TRIODE

Miniature type used as local oscillator in uhf television receivers covering the frequency range of 470 to 890 megacycles per second and employing series-connected heater strings. Outline 7A, OUTLINES SECTION. Heater volts (ac/dc), 3.15; amperes, 0.45; warm-up time (average), 11 seconds. Except for heater ratings, this type is identical with miniature type 6AF4-A.

3AF4A

Related types:
2AF4B, 6AF4A

TWIN DIODE

Miniature type having high-performance used as detector in television receivers employing series-connected heater strings. Outline 7A, OUTLINES SECTION. Heater volts (ac/dc), 3.15; amperes, 0.6; warm-up time (average), 11 seconds. Except for heater ratings, this type is identical with miniature type 6AL5.

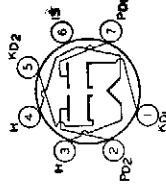

3AL5

Related types:
6AL5, 12AL5

HALF-WAVE VACUUM RECTIFIER

Duodecar type used to supply 100V high voltage to the anode of picture tubes in television receivers. Outline 16B, OUTLINES SECTION. Tube requires duodecar twelve-contact socket and may be mounted in any position. For high-voltage and X-ray safety considerations, refer to type 1B3-GT. Heater volts (ac/dc), 3.15; amperes, 0.22.

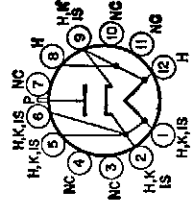

3AT2

PULSED RECTIFIER

For operation in a 525-line, 30-frame system

Maximum Ratings, (Design-Maximum Values):		
PEAK INVERSE PLATE VOLTAGE*.....	80000 max	volts
PEAK PLATE CURRENT.....	88 max	ma
AVERAGE PLATE CURRENT.....	1.7 max	ma

* The duration of the voltage pulse must not exceed 15 per cent of one horizontal scanning cycle. In a 525-line, 30-frame system, 15 per cent of one horizontal scanning cycle is 10 microseconds.

SHARP-CUTOFF PENTODE

Miniature type used as rf amplifier in television receivers employing series-connected heater strings. Outline 7B, OUTLINES SECTION. Heater volts (ac/dc), 3.15; amperes, 0.6; warm-up time (average), 11 seconds. Peak heater-cathode volts, 200 max. When the heater is positive with respect to the cathode, the dc component of the heater-cathode voltage must not exceed 100 volts. Except for heater and heater-cathode ratings, this type is identical with miniature type 6AU6.

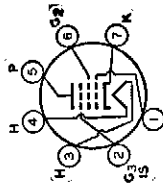

3AU6

Related types:
4AU6, 6AU6A, 12AU6

TWIN DIODE—HIGH-MU TRIODE

Miniature type used as combined detector, amplifier, and avc tube in television receivers employing series-connected heater strings. Outline 7B, OUTLINES SECTION. Heater volts (ac/dc), 3.15; amperes, 0.6; warm-up time (average), 11 seconds. Peak heater-cathode volts, 200 max. When the heater is positive with respect to the cathode, the dc component of the heater-cathode voltage must not exceed 100 volts. Except for heater and heater-cathode ratings, this type is identical with miniature type 6AV6.

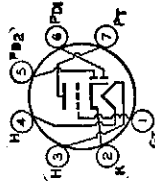

3AV6

Related types:
4AV6, 6AV6, 12AV6

3AW3

HALF-WAVE VACUUM RECTIFIER

Glass octal type used as rectifier of high-voltage pulses produced in the scanning system of television receivers. Outline 15B, OUTLINES SECTION. Tube requires octal socket and may be mounted in any position. Heater volts (ac/dc), 3.15; amperes, 0.22.

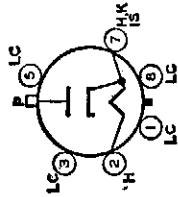

PULSED RECTIFIER

For operation in a 525-line, 50-frame system

	volts
Maximum Ratings, (Design-Maximum Values)	
PEAK INVERSE PLATE VOLTAGE*	30000 max
PEAK PLATE CURRENT	88 max
AVERAGE PLATE CURRENT	1.7 max

* The duration of the voltage pulse must not exceed 15 per cent of one horizontal scanning cycle. In a 525-line, 80-frame system, 15 per cent of one horizontal scanning cycle is 10 microseconds.

HALF-WAVE VACUUM RECTIFIER

Glass octal type used as rectifier of high-voltage pulses produced in the scanning systems of television receivers. Outline 26B, OUTLINES SECTION. Tube requires octal socket and may be mounted in any position. Low-potential circuits should not be connected to any of the socket terminals. Any or all of the following socket-terminal connections are permissible and may aid in corona reduction: socket terminals 1, 3, 5, and 7 may be connected together; socket terminal 4 may be connected to socket terminals 2 or 7, or may be used as a tie point for a heater-voltage dropping resistor. Heater volts (ac/dc), 3.15; amperes, 0.22. Maximum ratings as pulsed rectifier in 525-line, 80-frame system: peak inverse plate volts (absolute maximum), 35000 max (dc 25000 max); peak plate ma, 80 max; average plate ma, 1.1 max. For high-voltage considerations, see type 1B3-GT. Type 3B2 is used principally for renewal purposes.

3B2

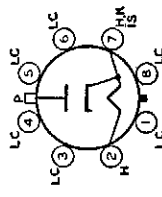

3BA6

Related types:
6BA6, 12BA6

REMOTE-CUTOFF PENTODE

Miniature type used as rf amplifier in standard broadcast and FM receivers, as well as in wide-band, high-frequency applications; for use in equipment employing series-connected heater strings. Outline 7B, OUTLINES SECTION. Heater volts (ac/dc), 3.15; amperes, 0.6; warm-up time (average), 11 seconds. Except for heater ratings, this type is identical with miniature type 6BA6.

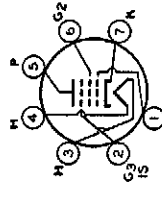

3BC5

Related types:
4BC5, 6BC5

SHARP-CUTOFF PENTODE

Miniature type used as rf or if amplifier in television receivers employing series-connected heater strings. Outline 7B, OUTLINES SECTION. Heater volts (ac/dc), 3.15; amperes, 0.6; warm-up time (average), 11 seconds. Peak heater-cathode volts, 200 max. When the heater is positive with respect to the cathode, the dc component of the heater-cathode voltage must not exceed 100 volts. Except for heater and heater-cathode ratings, this type is identical with miniature type 6BC5.

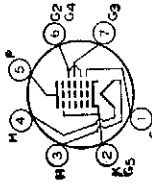
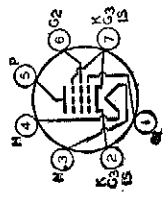

3BE6

Related types:
6BE6, 12BE6

PENTAGRID CONVERTER

Miniature type used as converter in superheterodyne circuits in both the standard broadcast and FM bands in equipment employing series-connected heater strings. Outline 7B, OUTLINES SECTION. Heater volts (ac/dc), 3.15; amperes, 0.6; warm-up time (average), 11 seconds. Except for heater ratings, this type is identical with miniature type 6BE6.



3BN4

3BN4A

Related types:
2BN4A, 6BN4A

MEDIUM-MU TRIODE

Miniature types used as rf amplifier in grid-drive circuits of vhf television tuners. The double base-pin connections for both cathode and grid reduce effective lead inductance and lead resistance with consequent reduction in input conductance. In addition, the bearing arrangement facilitates isolation of input and output circuits and permits short, direct connections to base-pin terminals. Outline 7B, OUTLINES SECTION. Heater volts (ac/dc), 3; amperes, 0.45; warm-up time (average), 11 seconds. Except for heater ratings, the 3BN4 and 3BN4-A are identical with miniature types 6BN4 and 6BN4-A, respectively. Type 3BN4 is a DISCONTINUED type listed for reference only.

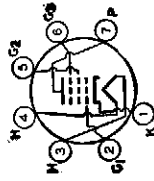

3BN6

Related types:
4BN6, 6BN6

BEAM TUBE

Miniature type used as combined limiter, discriminator, and af voltage amplifier in intercarrier television and FM receivers employing series-connected heater strings. Outline 7C, OUTLINES SECTION. Heater volts (ac/dc), 3.15; amperes, 0.6; warm-up time (average), 11 seconds. Except for heater ratings, this type is identical with miniature type 6BN6.

SHARP-CUTOFF TWIN PENTODE

Miniature type used as combined sync separator, sync clipper, and age amplifier tube in television receivers employing series-connected heater strings. Outline 8D, OUTLINES SECTION. Heater volts (ac/dc), 3.15; amperes, 0.6; warm-up time (average), 11 seconds. Except for heater ratings, this type is identical with miniature type 6BU8.

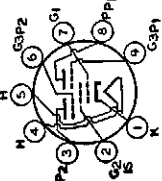

3BU8

Related types:
4BU8, 6BU8

PENTAGRID AMPLIFIER

Miniature type used as gated amplifier in television receivers employing series-connected heater strings. Outline 7B, OUTLINES SECTION. Heater volts (ac/dc), 3.15; amperes, 0.6; warm-up time (average), 11 seconds. Except for heater ratings, this type is identical with miniature type 6BY6.

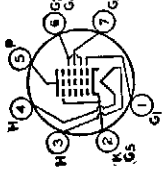

3BY6

Related type:
6BY6

3BZ6

Related types:
4BZ6, 6BZ6, 12BZ6

Miniature type used in gain-controlled video if stages of television receivers employing series-connected heater strings. Outline 7B, OUTLINES SECTION. Heater volts (ac/dc), 3.15; amperes, 0.6; warm-up time (average), 11 seconds. Peak heater-cathode volts when heater is negative with respect to cathode, 300 *max* (the dc component must not exceed 200 volts). Except for heater and heater-cathode ratings, this type is identical with miniature type 6BZ6.

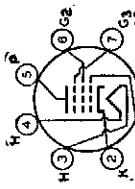

SHARP-CUTOFF PENTODE

Miniature type used as rf or if amplifier in television receivers employing series-connected heater strings. Outline 7B, OUTLINES SECTION. Heater volts (ac/dc), 3.15; amperes, 0.6; warm-up time (average), 11 seconds. Peak heater-cathode volts: heater negative with respect to cathode, 300 *max*; heater positive with respect to cathode, 200 *max* (the dc component must not exceed 100 volts). Except for heater and heater-cathode ratings, this type is identical with miniature types 6CB6 and 6CB6-A.

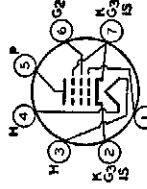

SHARP-CUTOFF PENTODE

Miniature type used as rf or if amplifier in vhf television receivers employing series-connected heater strings. Outline 7B, OUTLINES SECTION. Heater volts, 3.15; amperes, 0.6; heater warm-up time (average), 11 seconds. Except for heater ratings, this type is identical with miniature type 6CE5.

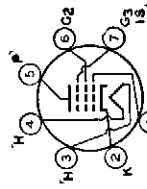

SHARP-CUTOFF PENTODE

Miniature type used as rf or if amplifier in television receivers employing series-connected heater strings. Outline 7B, OUTLINES SECTION. Heater volts (ac/dc), 3.15; amperes, 0.6; warm-up time (average), 11 seconds. Peak heater-cathode volts: heater negative with respect to cathode, 300 *max*; heater positive with respect to cathode, 200 *max* (the dc component must not exceed 100 volts). Except for heater and heater-cathode ratings, this type is identical with miniature type 6CF6.

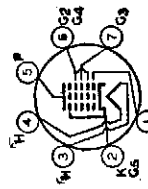

PENTAGRID AMPLIFIER

Miniature type used as gated amplifier in television receivers employing series-connected heater strings. Outline 7B, OUTLINES SECTION. Heater volts (ac/dc), 3.15; amperes, 0.6; warm-up time (average), 11 seconds. Except for heater ratings, this type is identical with miniature type 6CS6.

3BZ6

Related types:
4BZ6, 6BZ6, 12BZ6

3CB6

Related types:
4CB6, 6CB6, 6CB6A

3CE5

Related types:
6CE5

3CF6

Related types:
6CF6

3CS6

Related types:
4CS6, 6CS6

SHARP-CUTOFF TETRODE

Miniature type used as rf amplifier in vhf tuners of television receivers employing series-connected heater strings. Outline 7B, OUTLINES SECTION. Heater volts (ac/dc), 2.9; amperes, 0.45; warm-up time (average), 11 seconds. Except for heater ratings, this type is identical with miniature type 6CY5.

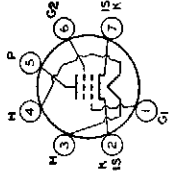

3CY5

Related types:
2CY5, 4CY5, 6CY5

FULL-WAVE VACUUM RECTIFIER

Glass octal type used as power supply in television receivers and other equipment having high dc requirements. Outline 19D, OUTLINES SECTION. Tube requires octal socket and may be operated in any position. It is especially important that this tube, like other power-handling tubes, be adequately ventilated. For discussion of Rating Chart, refer to INTERPRETATION OF TUBE DATA. Filament volts (ac/dc), 3.3; amperes, 3.8.

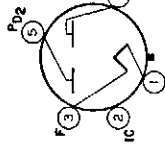

3DG4

FULL-WAVE RECTIFIER

Maximum Ratings, (Design-Maximum Values):
 PEAK INVERSE PLATE VOLTAGE volts
 PEAK PLATE CURRENT (Per Plate) 1050 *max* amperes
 HOT-SWITCHING TRANSIENT PLATE CURRENT (Per Plate) 1.2 *max* amperes
 AC PLATE SUPPLY VOLTAGE (Per Plate) 6.5 *max* amperes
 DC OUTPUT CURRENT (Per Plate) See Rating Chart
 BULB TEMPERATURE (at hottest point on bulb surface) See Rating Chart
 200 *max* °C

RATING CHART

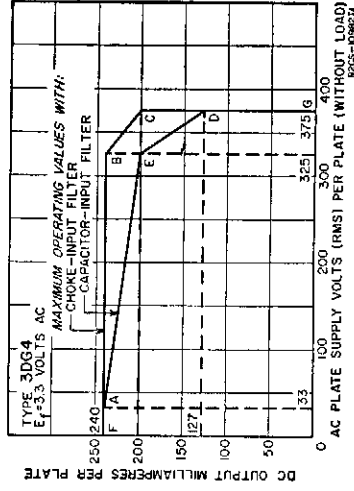

Typical Operation with Capacitor Input to Filter:

AC Plate-to-Plate Supply Voltage (rms)	550	volts
Filter-Input Capacitor	40	µf
Effective Plate-Supply Impedance per Plate	82	ohms
DC Output Voltage at Input to Filter (Approx.): At full-load current of 350 ma.	800	volts

Characteristics:

Tube Voltage Drop for plate current of 350 ma (per plate) 25 volts
 Higher values of capacitance than indicated may be used, but the effective plate-supply impedance may have to be increased to prevent exceeding the maximum rating for peak plate current.

SHARP-CUTOFF PENTODE

Miniature types used as intermediate-frequency amplifier in television receivers. Outline 7B, OUTLINES SECTION. Heater volts (ac/dc), 3.15, amperes, 0.6; warm-up time (average),

11 seconds. Peak heater-cathode volts: heater negative with respect to cathode, 300 *max*; heater positive with respect to cathode, 200 *max* (the dc component must not exceed 100 volts). Except for heater and heater-cathode ratings, this type is identical with miniature type 6DK6.

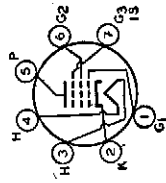

3DK6

Related types:
6DK6, 12DK6

SHARP-CUTOFF PENTODE

Miniature types used as FM detector in television receivers employing series-connected heater strings. Outline 7B, OUTLINES SECTION. Heater volts (ac/dc), 3.15; amperes, 0.6; warm-up time (average), 11 seconds. Except for heater ratings, these types are identical with miniature types 6DT6 and 6DT6-A, respectively. Type 3DT6 is a DISCONTINUED type listed for reference only.

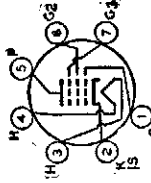

3DT6

Related types:
4DT6A, 6DT6A

MEDIUM-MU TRIODE

Miniature type used as a local-oscillator tube in uhf television receivers covering the frequency range from 470 to 890 megacycles and employing series-connected heater strings. OUTLINES SECTION. Heater volts (ac/dc), 3.2; amperes, 0.45; warm-up time (average), 11 seconds. Peak heater-cathode volts, 180 *max* (the dc component must not exceed 100 volts when heater is positive with respect to cathode). Except for heater and heater-cathode ratings, this type is identical with miniature type 6DZ4.

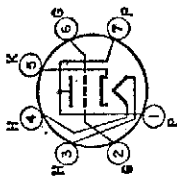

3DZ4

Related types:
2DZ4, 6DZ4

SHARP-CUTOFF PENTODE

Miniature type used as rf amplifier in vhf tuners of television receivers having series-connected heater strings. Outline 7B, OUTLINES SECTION. Heater volts (ac/dc) 2.9; amperes, 0.45; warm-up time (average), 11 seconds. Except for heater ratings, this type is identical with miniature type 6EA5.

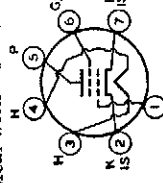

3EA5

Related types:
6EA5

SEMIREMOTE-CUTOFF PENTODE

Miniature type used as if-amplifier tube in television receivers. Outline 8C, OUTLINES SECTION. Heater volts (ac/dc), 3.4; amperes, 0.6; Except for heater ratings, this type is identical with miniature type 6EH7.

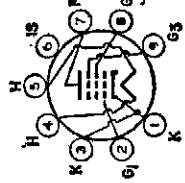

3EH7

Related types:
4EH7, 6EH7

SHARP-CUTOFF PENTODE

Miniature type used as if-amplifier tube in television receivers. Outline 8C, OUTLINES SECTION. Heater volts (ac/dc), 3.4; amperes, 0.6. Except for heater ratings, this type is identical with miniature type 6EJ7.

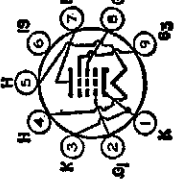

3EJ7

Related types:
4EJ7, 6EJ7

HIGH-MU TRIODE

Miniature type with frame grid used in vhf tuners of television receivers. Outline 7B, OUTLINES SECTION. Heater volts (ac/dc), 2.8; amperes, 0.45. Except for heater ratings, this type is identical with miniature type 6ER5.

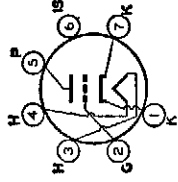

HIGH-MU TRIODE

Miniature type used as rf-amplifier tube in vhf tuners of television receivers employing series-connected heater strings. Outline 7B, OUTLINES SECTION. Heater volts (ac/dc), 3; amperes, 0.45; warm-up time (average), 11 seconds. Except for heater ratings, this type is identical with miniature type 6FH5.

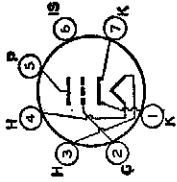

HIGH-MU TRIODE

Miniature type with frame grid used as grounded-cathode rf-amplifier tube in vhf tuners of television receivers employing series-connected heater strings. Outline 7B, OUTLINES SECTION. Heater volts (ac/dc), 2.8; amperes, 0.45; warm-up time (average), 11 seconds. Except for heater ratings, this type is identical with miniature type 6GK5.

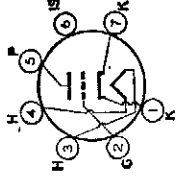

3GK5

Related types:
2GK5, 6GK5

SHARP-CUTOFF TWIN PENTODE

Miniature type used as combined sync separator, sync clipper, and age amplifier tube in television receivers employing series-connected heater strings. Outline 8D, OUTLINES SECTION. Heater volts (ac/dc), 3.15; amperes, 0.6. Except for heater ratings, this type is identical with miniature type 4GS8/4BU8.

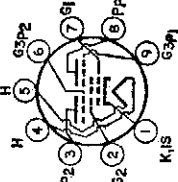

3GS8/

Related types:
4GS8/4BU8

3BU8

Related types:
4GS8/4BU8

HIGH-MU TRIODE

Miniature type used as rf-amplifier tube in vhf television tuners. Outline 7A, OUTLINES SECTION. Heater volts (ac/dc), 2.7; amperes, 0.45. Except for heater ratings, this type is identical with miniature type 6HA5.

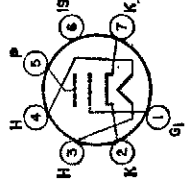

3HA5

Related types:
6HA5

SHARP-CUTOFF TWIN PENTODE

Miniature type used in age amplifier, sync, and noise-limiting circuits of television receivers employing series-connected heater strings. One pentode unit is used as a combined sync separator and sync clipper; the other pentode unit is used as the age amplifier.

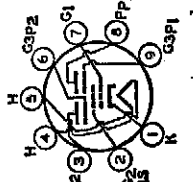

3HS8

Related types:
4HS8, 6HS8

3EJ7

Related types:
4EJ7, 6EJ7

Outline 8D, OUTLINES SECTION. Heater volts (ac/dc), 3.15; amperes, 0.6; warm-up time (average), 11 seconds. Except for heater ratings, this type is identical with miniature type 6H8S.

3JC6

Related types:
4JC6, 6JC6

SHARP-CUTOFF PENTODE

Miniature type with frame grid used in if-amplifier stages of television receivers utilizing intermediate frequencies in the order of 40 megacycles and employing series-connected heater and OUTLINES SECTION. Heater volts (ac/dc), 3.5; amperes, 0.6; heater warm-up time (average), 11 seconds. Except for heater ratings, this type is identical with miniature type 6JC6.

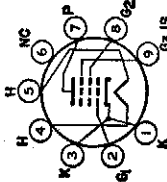

3JD6

Related types:
4JD6, 6JD6

SHARP-CUTOFF PENTODE

Miniature type used as if-amplifier tube in television receivers utilizing intermediate frequencies in the order of 40 megacycles and employing series-connected heater strings. Outline 8B, OUTLINES SECTION. Heater volts (ac/dc), 3.5; amperes, 0.6; warm-up time (average), 11 seconds. Except for heater ratings, this type is identical with miniature type 6JD6.

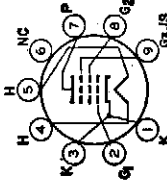

3LF4

BEAM POWER TUBE

Glass lock-in type used in output stage of ac/dc battery portable receivers. Outline 13A, OUTLINES SECTION. Tube requires lock-in socket. Filament volts (dc), 1.4 (parallel), 2.8 (series); amperes, 1.1 (parallel), 0.05 (series). For electrical characteristics, refer to glass-ocul type 3Q5-GT. Type 3LF4 is used principally for renewal purposes.

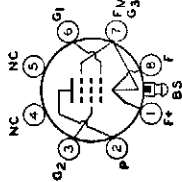

3Q4

POWER PENTODE

Miniature type used in output stage of lightweight, compact, portable battery-operated equipment. Outline 7B, OUTLINES SECTION. Except for terminal connections, types 3Q4 and 3V4 are identical. Refer to type 3V4 for ratings and typical operation. Type 3Q4 is used principally for renewal purposes.

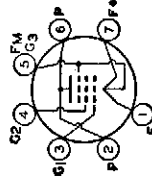

3Q5GT

BEAM POWER TUBE

Glass ocul type used in output stage of ac/dc battery portable receivers. Outline 14C, OUTLINES SECTION. This type may be supplied with pin 1 omitted. Filament volts (dc), 2.8 in series filament arrangement and 1.4 in parallel arrangement; amperes 0.06 (series), 0.1 (parallel). Typical operation as Class A1 amplifier: plate and grid-No.2 volts, 110 *max*; grid-No.1 volts, -6.6; peak at grid-No.2 ma., 1.1 (series), 1.4 (parallel); plate ma., 8.5 (series), 10 (parallel); grid-No.2 volts, 1.1 (series), 1.4 (parallel); total cathode ma., 6 *max* for each 1.4-volt filament section; plate resistance (approx.), 0.11 megohm (series), 0.1 megohm (parallel); transconductance, 2000 μ hos (series), 2200 μ hos (parallel); load resistance, 8000 ohms; total harmonic distortion, 8.5 per cent (series), 6 per cent (parallel); max.-signal power output, 880 *mW* (series), 400 *mW* (parallel). This type is used principally for renewal purposes.

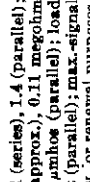

POWER PENTODE

Miniature type used in output stage of lightweight, compact, portable, battery-operated equipment. Outline 7B, OUTLINES SECTION. Tube requires miniature seven-contact socket. Filament volts (dc), 2.8 (series), 1.4 (parallel); amperes, 0.05 (series); 0.1 (parallel). Typical operation as class A1 amplifier: plate and grid-No.2 volts, 67.5 (90 *max*); grid-No.1 volts, -7; peak at grid-No.1 volts, 7; zero-signal plate ma., 5 (series) 7.2 (parallel); zero-signal grid-No.2 ma., 1.2 (series), 1.5 (parallel); plate resistance (approx.), 0.1 megohm; transconductance, 1400 μ hos (series), 1550 μ hos (parallel); load resistance, 5000 ohms; maximum-signal power output, 160 milliwatts (series), 180 milliwatts (parallel). This type is used principally for renewal purposes.

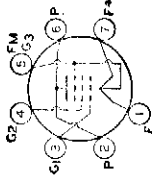

POWER PENTODE

Miniature type used in output stage of lightweight, compact, portable, battery-operated equipment. Outline 7B, OUTLINES SECTION. Tube requires miniature seven-contact socket. Filament volts (dc), 2.8 (series), 1.4 (parallel); amperes, 0.05 (series), 0.1 (parallel). Typical operation as class A1 amplifier: plate and grid-No.2 volts, 90 (100 *max*); grid-No.1 volts, -4.5; peak at grid-No.1 volts, 4.5; zero-signal plate ma., 7.7 (series), 9.5 (parallel); grid-No.2 ma., zero-signal, 1.7 (series), 2.1 (parallel); plate resistance (approx.), 0.12 megohm (series), .1 megohm (parallel); transconductance, 2000 μ hos (series), 2150 μ hos (parallel); load resistance, 10000 ohms; maximum-signal power output, 240 milliwatts (series), 270 milliwatts (parallel). This type is used principally for renewal purposes.

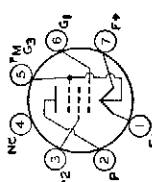

SHARP-CUTOFF PENTODE

Miniature type used as rf amplifier in television receivers employing series-connected heater strings. Outline 7B, OUTLINES SECTION. Heater volts (ac/dc), 4.2; amperes, 0.45; warm-up time (average), 11 seconds. Peak heater-cathode volts: heater negative with respect to cathode, 200 *max*; heater positive with respect to cathode, 200 *max* (the dc component must not exceed 100 volts). Except for heater and heater-cathode ratings, this type is identical with miniature type 6AU6.

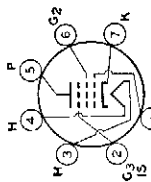

4AU6

Related types:
3AU6, 6AU6A, 12AU6

TWIN DIODE—HIGH-MU TRIODE

Miniature type used as combined detector, amplifier, and avc tube in automobile and ac-operated radio receivers employing series-connected heater strings. Outline 7B, OUTLINES SECTION. Heater volts (ac/dc), 4.2; amperes, 0.45; warm-up time (average), 11 seconds. Except for heater ratings, this type is identical with miniature type 6AV6.

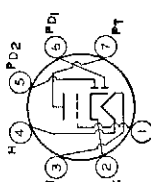

4AV6

Related types:
3AV6, 6AV6, 12AV6

SHARP-CUTOFF PENTODE

Miniature type used in compact radio equipment as an rf or if amplifier at frequencies up to 400 megacycles per second. Outline 7B, OUTLINES SECTION. Heater volts (ac/dc), 4.2;

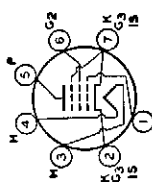

4BC5

Related types:
3BC5, 6BC5

amperes, 0.45; warm-up time (average), 11 seconds. Peak heater-cathode volts: heater negative with respect to cathode, 200 *max*; heater positive with respect to cathode, 200 *max* (the dc component must not exceed 100 volts). Except for heater and heater-cathode ratings, this type is identical with miniature type 6BC5.

MEDIUM-MU TWIN TRIODE

Miniature type used in direct-coupled cathode-drive rf amplifier circuits of vhf television tuners employing series-connected heater strings. Outline 8B, OUTLINES SECTION.

Heater volts (ac/dc), 4.2; amperes, 0.6; warm-up time (average), 11 seconds. Except for heater rating, this type is identical with miniature type 6BC8.

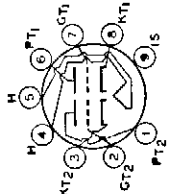

4BC8

Related types:
6BC8

**MEDIUM-MU TRIODE—
SHARP-CUTOFF PENTODE**

Miniature type used in frequency-changer service in television receivers. Outline 8B, OUTLINES SECTION, Heater volts (ac/dc), 4.6; amperes, 0.6. Except for heater ratings, this type is identical with miniature type 6BL8.

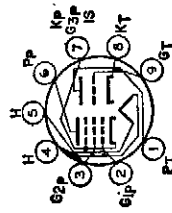

4BL8

Related types:
6BL8

BEAM TUBE

Miniature type used as combined limiter, discriminator, and audio-voltage amplifier in intercarrier television and FM receivers employing series-connected heater strings. Outline 7C, OUTLINES SECTION. Heater volts (ac/dc), 4.2; amperes, 0.45; warm-up time (average), 11 seconds. Peak heater-cathode volts, 200 *max*. When the heater is positive with respect to the cathode, the dc component of the heater-cathode voltage must not exceed 100 volts. Except for heater and heater-cathode ratings, this type is identical with miniature type 6BN6.



4BN6

Related types:
3BN6, 6BN6

MEDIUM-MU TWIN TRIODE

Miniature type used in direct-coupled cathode-drive rf amplifier circuits of vhf television tuners employing series-connected heater strings. Outline 8B, OUTLINES SECTION.

Heater volts (ac/dc), 4.2; amperes, 0.6; warm-up time (average), 11 seconds. Except for heater ratings, this type is identical with miniature type 6BQ7-A.

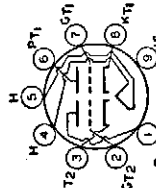

4BQ7A

Related types:
5BQ7A, 6BQ7A

MEDIUM-MU TWIN TRIODE

Miniature type used in direct-coupled cathode-drive rf amplifier circuits of vhf television tuners employing series-connected heater strings. Outline 8B, OUTLINES SECTION.

Heater volts (ac/dc), 4.5; amperes, 0.6; warm-up time (average), 11 seconds. Except for heater ratings, this type is identical with miniature type 6BS8.

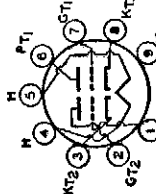

4BS8

Related types:
6BS8

SHARP-CUTOFF TWIN PENTODE

Miniature type used as combined sync separator, sync clipper, and age amplifier tube in television receivers employing series-connected heater strings. Outline 8D, OUTLINES SECTION.

Heater volts (ac/dc), 4.2; amperes, 0.45; warm-up time (average), 11 seconds. Except for heater ratings, this type is identical with miniature type 6BU8.

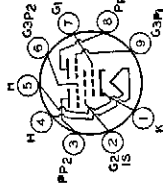

4BU8

Related types:
3BU8, 6BU8

SEMIREMOTE-CUTOFF PENTODE

Miniature type used in gain-controlled video if stages of television receivers employing series-connected heater strings. Outline 7B, OUTLINES SECTION. Heater volts

(ac/dc), 4.2; amperes, 0.45; warm-up time (average), 11 seconds. Except for heater ratings, this type is identical with miniature type 6EZ6.

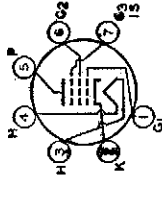

4BZ6

Related types:
3BZ6, 6BZ6, 12BZ6

MEDIUM-MU TWIN TRIODE

Miniature type used in direct-coupled cathode-drive rf amplifier circuits of vhf television tuners employing series-connected heater strings. Outline 8B, OUTLINES SECTION.

Heater volts (ac/dc), 4.2; amperes, 0.6; warm-up time (average), 11 seconds. Except for heater ratings, this type is identical with miniature type 6BZ7.

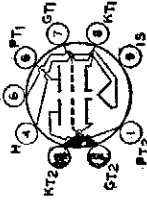

4BZ7

Related types:
6BZ7

SHARP-CUTOFF PENTODE

Miniature type used as if and as rf amplifier in television receivers employing series-connected heater strings. Outline 7B, OUTLINES SECTION.

Heater volts (ac/dc), 4.2; amperes, 0.45; warm-up time (average), 11 seconds. Peak heater-cathode volts: heater negative with respect to cathode, 300 *max* (the dc component must not exceed 200 volts); heater positive with respect to cathode, 200 *max* (the dc component must not exceed 100 volts). Except for heater and heater-cathode ratings, this type is identical with miniature types 6CB6 and 6CB6-A.

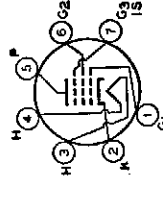

4CB6

Related types:
3CB6, 6CB6, 6CB6A

PENTAGRID AMPLIFIER

Miniature type used as a gated amplifier in television receivers. In such service, it may be used as a combined sync separator and sync clipper. Outline 7B, OUTLINES SECTION.

Heater volts (ac/dc), 4.2; amperes, 0.45; warm-up time (average), 11 seconds. Except for heater ratings, this type is identical with miniature type 6CS6.

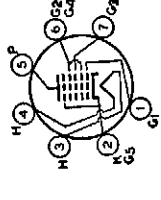

4CS6

Related types:
3CS6, 6CS6

SHARP-CUTOFF TETRODE

Miniature type used as rf amplifier in vhf tuners of television receivers employing series-connected heater strings. Outline 7B, OUTLINES SECTION. Heater volts (ac/dc), 4.5; amperes, 0.3; warm-up time (average), 11 seconds. Except for heater ratings, this type is identical with miniature type 6CY5.

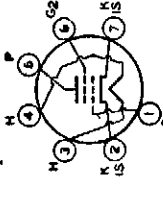

4CY5

Related types:
2CY5, 3CY5, 6CY5

SHARP-CUTOFF PENTODE

Miniature type used in the gain-controlled picture if stages of television receivers utilizing an intermediate frequency in the order of 40 megacycles per second. Also used as an rf amplifier in vhf television tuners. Outline 7B, OUTLINES SECTION. Heater volts (ac/dc), 4.2; amperes, 0.45; warm-up time (average), 11 seconds. Except for heater ratings, this tube is identical with miniature type 6DE6.

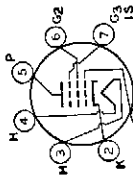

4DE6

Related types:
6DE6

SHARP-CUTOFF PENTODE

Miniature types used as FM detector in television receivers employing series-connected heater strings. Outline 7B, OUTLINES SECTION. Heater volts (ac/dc), 4.2; amperes, 0.45; warm-up time (average), 11 seconds. Except for heater ratings, these types are identical with miniature types 6DT6 and 6DT6-A, respectively. Type 4DT6 is a DISCONTINUED type listed for reference only.

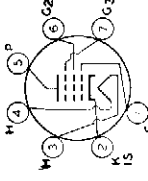

4DT6

Related types:
3DT6A, 6DT6A

SEMI REMOTE-CUTOFF PENTODE

Miniature type used as if-amplifier tube in television receivers. Outline 8C, OUTLINES SECTION. Heater volts (ac/dc), 4.4; amperes, 0.45; Except for heater ratings, this type is identical with miniature type 6EH7.

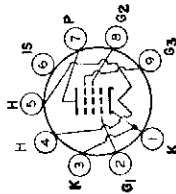

4EH7

Related types:
3EH7, 6EH7

SHARP-CUTOFF PENTODE

Miniature type used as if-amplifier tube in television receivers. Outline 8C, OUTLINES SECTION. Heater volts (ac/dc), 4.4; amperes, 0.45. Except for heater ratings, this type is identical with miniature type 6EJ7.

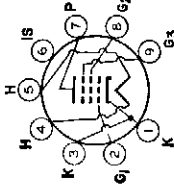

4EJ7

Related types:
3EJ7, 6EJ7

VARIABLE-MU TWIN TRIODE

Miniature type used in direct-coupled cathode-drive rf amplifier circuits of television receivers employing series-connected heater strings. Outline 8B, OUTLINES SECTION.

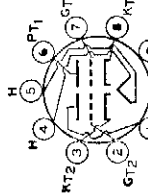

4ES8

Related types:
6ES8

Heater volts (ac/dc), 4; amperes, 0.6; warm-up time (average), 11 seconds. Except for heater ratings, this type is identical with miniature type 6ES8.

SHARP-CUTOFF PENTODE

Miniature type used in the gain-controlled picture-if stages of vhf television receivers operating at an intermediate frequency in the order of 40 megacycles per second. Outline 7B, OUTLINES SECTION. Heater volts (ac/dc), 4.2; amperes, 0.6; warm-up time (average), 11 seconds. Except for heater ratings, this type is identical with miniature type 6EW6.

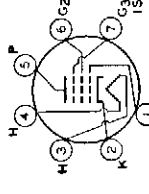

4EW6

Related types:
5EW6, 6EW6

SHARP-CUTOFF TWIN PENTODE

Miniature type used as combined sync separator, sync clipper, and agc amplifier tube in television receivers employing series-connected heater strings. Outline 8D, OUTLINES SECTION. Tube requires miniature nine-contact socket and may be mounted in any position.

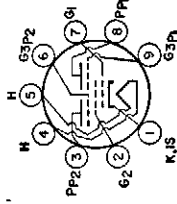

4GS8
/4BU8

Related type:
3GS8/3BU8

Heater Voltage (ac/dc)	4.2 volts
Heater Current	0.45 amperes
Heater Warm-Up Time (Average)	11 seconds
Direct Inter-Electrode Capacitances:	
Grid No.3 to Plate (Each Unit)	2 pf
Grid No.1 to All Other Electrodes (Each Unit)	6 pf
Plate to All Other Electrodes (Each Unit)	3.8 pf
Grid No.3 of Unit No.1 to Grid No.3 of Unit No.2	3.2 pf
	0.015 mac

CLASS A₁ AMPLIFIER

Maximum Ratings, (Design-Maximum Values):

Plate Voltage (Each Unit)	100 volts
Grid-No.3 (SUPPRESSOR-GRID) VOLTAGE (Each Unit)	100 macr
Peak positive value	50 macr
DC negative value	-0 macr
DC positive value	10 macr
Grid-No.2 (SCREEN-GRID) VOLTAGE	180 macr
Grid-No.1 (CONTROL-GRID) VOLTAGE, Negative bias value	-6 macr
Cathode Current	-12 macr
Grid-No.2 Input	0.15 macr
Plate Dissipation (Each Unit)	1.1 macr
Peak Heater-Cathode Voltage:	200 macr
Heater negative with respect to cathode	volts
Heater positive with respect to cathode	200 macr

Characteristics:

Plate Voltage (Each Unit)	100 volts
Grid-No.3 Voltage (Each Unit)	-10 volts
Grid-No.2 Voltage	67.5 volts
Grid-No.1 Voltage	—
Plate Current (Each Unit)	2 ma
Grid-No.2 Current	3-5 ma
Cathode Current	7.7 ma

With One Unit Operating*

Plate Voltage	100 volts
Grid-No.3 Voltage	0 volts
Grid-No.2 Voltage	67.5 volts
Grid-No.1 Voltage	0 volts
Grid-No.3 Transconductance	270 amhos
Grid-No.1 Transconductance	— amhos
Plate Current	— ma
Grid-No.3 Voltage (Approx.) for plate current of 100 μ a	-3.7 volts
Grid-No.1 Voltage (Approx.) for plate current of 100 μ a	-2 volts

Maximum Circuit Values:

Grid-No.3-Circuit Resistance (Each Unit)	0.5 macr
Grid-No.1-Circuit Resistance	0.5 macr

*The dc component must not exceed 100 volts.
* Adjusted to give a dc grid-No.1 current of 100 microamperes.
* With plate and grid No.3 of the other unit connected to ground.

POWER PENTODE

Miniature type used in audio output stages of radio and television receivers employing series-connected heater strings. Outline 7B, OUTLINES SECTION. Tube requires miniature seven-contact socket and may be mounted in any position. Heater volts (ac/dc), 4; amperes, 0.6; warm-up time (average), 11 seconds.

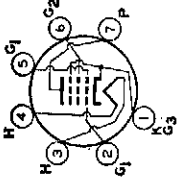

4GZ5

0.5 macr
0.5 macr

CLASS A₁ AMPLIFIER

Maximum Ratings, (Design-Maximum Values):

PLATE VOLTAGE.....	300 max	volts
GRID-NO.2 (SCREEN-GRID) VOLTAGE.....	300 max	volts
GRID-NO.1 (CONTROL-GRID) VOLTAGE, Positive-bias value.....	0 max	volts
AVERAGE CATHODE CURRENT.....	30 max	ma
PLATE DISSIPATION.....	4.8 max	watts
GRID-NO.2 INPUT.....	1.1 max	watts
PEAK HEATER-CATHODE VOLTAGE:		
Heater negative with respect to cathode.....	200 max	volts
Heater positive with respect to cathode.....	200 max	volts
BULB TEMPERATURE (At hottest point).....	200 max	°C

Typical Operation:

Plate Supply Voltage.....	250	volts
Grid-No.2 Supply Voltage.....	250	volts
Cathode-Bias Resistor.....	270	ohms
Peak AF Grid-No.1 Voltage.....	3.8	volts
Zero-Signal Plate Current.....	16	ma
Maximum-Signal Plate Current.....	16	ma
Zero-Signal Grid-No.2 Current.....	2.7	ma
Maximum-Signal Grid-No.2 Current.....	5	ma
Plate Resistance (Approx.).....	0.15	megohm
Transconductance.....	8400	amhos
Load Resistance.....	16000	ohms
Total Harmonic Distortion.....	10	per cent
Maximum-Signal Power Output.....	1.8	watts

Maximum Circuit Values:

Grid-No.1-Circuit Resistance: For fixed-bias operation.....	0.5 max	megohm
For cathode-bias operation.....	1 max	megohm

- The dc component must not exceed 100 volts.
- Bypassed.

4HM6

SHARP-CUTOFF PENTODE

Miniature type with frame grid used in the if-amplifier stages of television receivers employing series-connected heater strings. Outline 8B, OUTLINES SECTION. Tube requires miniature nine-contact socket and may be mounted in any position. Heater volts (ac/dc), 4.2; amperes, 0.45; warm-up time (average), 11 seconds.

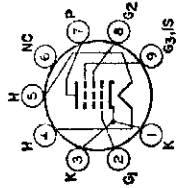

CLASS A₁ AMPLIFIER

Maximum Ratings, (Design-Maximum Values):

PLATE VOLTAGE.....	250 max	volts
GRID-NO.2 (SCREEN-GRID) SUPPLY VOLTAGE.....	250 max	volts
GRID-NO.2 VOLTAGE.....	-60 max	volts
GRID-NO.1 (CONTROL-GRID) VOLTAGE, Negative-bias value.....	25 max	ma
CATHODE CURRENT.....	2.5 max	watts
PLATE DISSIPATION.....		
Grid-No.2 INPUT: For grid-No.2 voltages up to 125 volts.....	0.6 max	watt
For grid-No.2 voltages between 125 and 150 volts.....	See curve page 70	
PEAK HEATER-CATHODE VOLTAGE: Heater negative with respect to cathode.....	200 max	volts
Heater positive with respect to cathode.....	200 max	volts

Characteristics:

Plate Supply Voltage.....	125	volts
Grid No.3 (Suppressor Grid).....	Connected to cathode at socket	
Grid-No.2 Supply Voltage.....	125	volts
Cathode-Bias Resistor.....	56	ohms
Plate Resistance (Approx.).....	0.156	megohm
Transconductance.....	15000	amhos
Plate Current.....	13	ma
Grid-No.2 Current.....	8.2	ma
Grid-No.1 Voltage (Approx.) for transconductance of 100 amhos.....	-3	volts

Maximum Circuit Values:

Grid-No.1-Circuit Resistance: For fixed-bias operation.....	0.25 max	megohm
For cathode-bias operation.....	1 max	megohm

- The dc component must not exceed 100 volts.

SHARP-CUTOFF TWIN PENTODE

Miniature type used in agc amplifier, sync, and noise-limiting circuits of television receivers employing series-connected heater strings. One pentode unit is used as a combined sync separator and sync clipper; the other pentode unit is used as the agc amplifier. Outline 8D, OUTLINES SECTION. Heater volts (ac/dc), 4.2; amperes, 0.45; warm-up time (average), 11 seconds. Except for heater ratings, this type is identical with miniature type 6HS8.

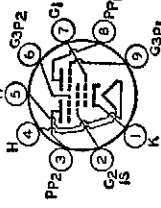

SEMIREMOTE-CUTOFF PENTODE

Miniature type with frame grid used in the if-amplifier stages of television receivers employing series-connected heater strings. Outline 8B, OUTLINES SECTION. Tube requires miniature nine-contact socket and may be mounted in any position. Heater volts (ac/dc), 4.2; amperes, 0.45; warm-up time (average), 11 seconds.

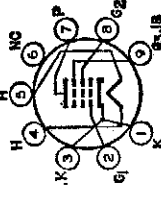

CLASS A₁ AMPLIFIER

Maximum Ratings, (Design-Maximum Values):

PLATE VOLTAGE.....	250 max	volts
GRID-NO.2 (SCREEN-GRID) SUPPLY VOLTAGE.....	250 max	volts
GRID-NO.1 VOLTAGE.....	See curve page 70	
GRID-NO.1 (CONTROL-GRID) VOLTAGE, Negative-bias value.....	-60 max	volts
CATHODE CURRENT.....	25 max	ma
PLATE DISSIPATION.....	2.5 max	watts
GRID-NO.2 INPUT: For grid-No.2 voltages up to 125 volts.....	0.6 max	watt
For grid-No.2 voltages between 125 and 250 volts.....	See curve page 70	
PEAK HEATER-CATHODE VOLTAGE: Heater negative with respect to cathode.....	200 max	volts
Heater positive with respect to cathode.....	200 max	volts

Characteristics:

Plate Supply Voltage.....	125	volts
Grid No.3 (Suppressor Grid).....	Connected to cathode at socket	
Grid-No.2 Supply Voltage.....	125	volts
Cathode-Bias Resistor.....	56	ohms
Plate Resistance (Approx.).....	0.143	megohm
Transconductance.....	14000	amhos
Plate Current.....	15	ma
Grid-No.2 Current.....	4	ma
Grid-No.1 Voltage (Approx.) for transconductance of 100 amhos.....	-4.5	volts

Maximum Circuit Values:

Grid-No.1-Circuit Resistance: For fixed-bias operation.....	0.25 max	megohm
For cathode-bias operation.....	1 max	megohm

- The dc component must not exceed 100 volts.

SHARP-CUTOFF PENTODE

Miniature type with frame grid used in if-amplifier stages of television receivers utilizing intermediate frequencies in the order of 40 megacycles and employing series-connected heater strings. Outline 8B, OUTLINES SECTION. Heater volts (ac/dc), 4.5; amperes, 0.45; warm-up time (average), 11 seconds. Except for heater ratings, this type is identical with miniature type 6JC6.

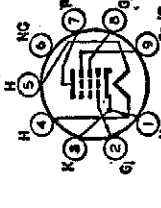

4JC6

Related types:
3JC6, 6JC6

4JD6

Related types:
3JD6, 6JD6

line 8B, OUTLINES SECTION. Heater volts (ac/dc), 4.7; amperes, 0.6; warm-up time (average), 11 seconds. Except for heater ratings, this type is identical with miniature type 6JD6.

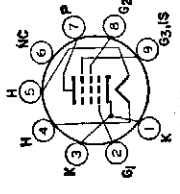

SHARP-CUTOFF PENTODE

Miniature type used as if-amplifier tube in television receivers utilizing intermediate frequencies in the order of 40 megacycles and employing series-connected heater strings. Out-

5AM8

Related types:
6AM8A

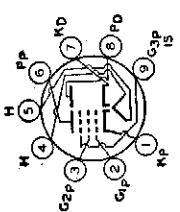

DIODE—SHARP-CUTOFF PENTODE

Miniature type used in diversified applications in television receivers employing series-connected heater strings. The pentode unit is used as an amplifier and the high-perveance diode as a detector or dc restorer. Outline 8B, OUTLINES SECTION. Heater volts (ac/dc), 4.7; amperes, 0.6; warm-up time (average), 11 seconds. Except for heater ratings, this type is identical with miniature type 6AM8-A.

5AN8

Related types:
6AN8A

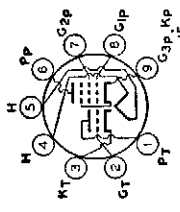

MEDIUM-MU TRIODE—SHARP-CUTOFF PENTODE

Miniature type used in a wide variety of applications in television receivers employing series-connected heater strings. The pentode unit is used as an amplifier and the triode unit is used in oscillator or sync circuits. Outline 8B, OUTLINES SECTION. Heater volts (ac/dc), 4.7; amperes, 0.6; warm-up time (average), 11 seconds. Except for heater ratings, this type is identical with miniature type 6AN8.

5AQ5

Related types:
6AQ5A, 12AQ5

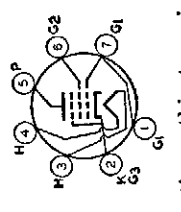

BEAM POWER TUBE

Miniature type used as audio amplifier in television receivers employing series-connected heater strings. Outline 7C, OUTLINES SECTION. Heater volts (ac/dc), 4.7; amperes, 0.6; warm-up time (average), 11 seconds. Except for heater ratings, this type is identical with miniature type 6AQ5-A.

5AS4

5AS4A

FULL-WAVE VACUUM RECTIFIER
Glass octal types used in power supply of television receivers having high dc requirements. Type 5AS4-A, Outline 19C, OUTLINES SECTION. Type 5AS4 maximum dimensions:

over-all length, 5-1/8 inches; seated height, 4-9/16 inches; diameter, 2-1/16 inches. Type 5AS4-A may be supplied with pins 3, 5, and 7 omitted. Tubes require octal socket. Vertical mounting is preferred, but horizontal mounting is permissible if pins 1 and 4 are in vertical plane. It is especially important that these tubes, like other power-handling tubes, be adequately ventilated. Heater volts (ac), 5.0; amperes, 3.0. For maximum ratings, typical operation, and curves, refer to type 5U4-GB. Type 5AS4 is a DISCONTINUED type listed for reference only.

DIODE—SHARP-CUTOFF PENTODE

Miniature type used in diversified applications in television receivers employing series-connected heater strings. The pentode unit is used as an amplifier and the high-perveance diode as a detector or dc restorer. Outline 8B, OUTLINES SECTION. Heater volts (ac/dc), 4.7; amperes, 0.6; warm-up time (average), 11 seconds. Except for heater ratings, this type is identical with miniature type 6AS8.

5AS8

Related types:
6AS8

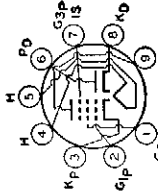

MEDIUM-MU TRIODE—SHARP-CUTOFF PENTODE

Miniature type used as combined oscillator and mixer tube in television receivers employing series-connected heater strings. Outline 8B, OUTLINES SECTION. Heater volts (ac/dc), 4.7; amperes, 0.6; warm-up time (average), 11 seconds. Except for heater ratings, this type is identical with miniature type 6AT8-A.

5AT8

Related types:
6AT8A

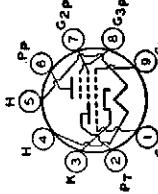

FULL-WAVE VACUUM RECTIFIER

Glass octal type used as power supply in television receivers and other equipment having high dc requirements. Maximum dimensions: over-all length, 4-3/4 inches; seated height, 4-3/16 inches; diameter, 1-11/16 inches. Tube requires octal socket and must be used in vertical position; horizontal operation is permissible only if pins 2 and 4 are in vertical plane. It is especially important that this tube, like other power-handling tubes, be adequately ventilated. Filament volts (ac/dc), 5; amperes, 3.75. For discussion of Rating Chart, refer to INTERPRETATION OF TUBE DATA.

5AU4

FULL-WAVE RECTIFIER

Maximum Ratings, (Design-Center Values):
PEAK INVERSE PLATE VOLTAGE 1400 max volts
PEAK PLATE CURRENT (Per Plate) 1075 max ma
HOT-SWITCHING TRANSIENT PLATE CURRENT (Per Plate), maximum duration 0.2 second 5.25 max amperes
AC PLATE SUPPLY VOLTAGE (Per Plate, rms) See Rating Chart
DC OUTPUT CURRENT (Per Plate) See Rating Chart

RATING CHART

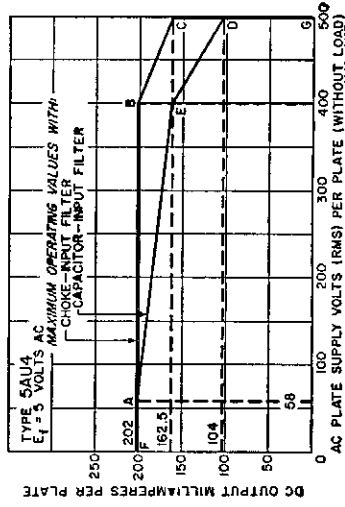

Typical Operation:

Filter Input	Choke
AC Plate-to-Plate Supply Voltage (rms)	1000
Filter-Input Capacitor	—
Effective Plate Supply Impedance per Plate	—
Filter-Input Choke	10
DC Output Current	325
DC Output Voltage at Input to Filter (Approx.)	395
Characteristics, Instantaneous Value:	50
Tube Voltage Drop for plate current of 350 ma (per plate)	—

5AV8
MEDIUM-MU TRIODE—
SHARP-CUTOFF PENTODE

Miniature type used in a wide variety of applications in television receivers employing series-connected heater strings. Outline 8B, OUTLINES SECTION. Tube requires miniature nine-contact socket and may be mounted in any position.

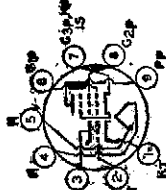

HEATER VOLTAGE (AC/DC)	4.7	volts
HEATER CURRENT	0.6	amperes
HEATER WARM-UP TIME (Average)	11	seconds
DIRECT INTERELECTRODE CAPACITANCES:		
Triode Unit:		
Grid to Plate	1.5	pf
Grid to Cathode	2	pf
Plate to Cathode and Heater	0.54	pf
Pentode Unit:		
Grid No.1 to Plate	0.04	max
Grid No.1 to Cathode, Heater, Grid No.2, Grid No.3, and Internal Shield	7	pf
Plate to Cathode, Heater, Grid No.2, Grid No.3, and Internal Shield	3	pf
Triode Grid to Pentode Plate	0.005	pf
Pentode Grid No.1 to Triode Plate	0.006	pf
Pentode Plate to Triode Plate	0.045	pf

CLASS A₁ AMPLIFIER

Maximum Ratings, (Design-Center Values):	Triode Unit	Pentode Unit
PLATE VOLTAGE	300	300
GRID NO.2 SUPPLY VOLTAGE	—	—
GRID-NO. 2 (SCREEN-GRID) VOLTAGE	0	0
GRID-NO.1 (CONTROL-GRID) VOLTAGE, Positive-bias value	2.5	2
PLATE DISSIPATION	—	—
GRID-NO.2 INPUT:		
For grid-No.2 voltages up to 150 volts	—	0.5
For grid-No.2 voltages between 150 and 300 volts	—	—
PEAK HEATER-CATHODE VOLTAGE:		
Heater negative with respect to cathode	200	200
Heater positive with respect to cathode	200	200

Characteristics:

Plate Supply Voltage	200	volts
Grid-No.2 Supply Voltage	-6	volts
Grid-No.1 Voltage	—	ohms
Cathode-Bias Resistor	19	ohms
Amplification Factor	5750	ohms
Plate Resistance (Approx.)	8500	ohms
Transconductance	-19	volts
Grid-No.1 Voltage (Approx.) for plate current of 10 μ a	13	ma
Plate Current	—	ma
Grid-No.2 Current	—	ma
Grid-No.1-Circuit Resistance:		
For fixed-bias operation	0.5	megohm
For cathode-bias operation	1.0	megohm

* The dc component must not exceed 100 volts.
* If either unit is operating at maximum rated conditions, grid-No.1-circuit resistance for both units should not exceed the stated values.

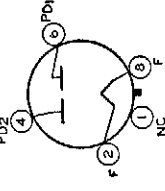

FULL-WAVE VACUUM RECTIFIER

Glass octal type used in power supplies of radio and television receivers having high dc requirements. Maximum dimensions: over-all length, 5-3/16 inches; seated length, 4-5/8 inches; diameter, 1-9/16 inches. Tube requires octal socket and may be operated in any position. It is especially important that this tube, like other power-handling tubes, be adequately ventilated. Filament volts (ac/dc), 5; amperes, 3.7. For discussion of Rating Chart, refer to INTERPRETATION OF TUBE DATA.

FULL-WAVE RECTIFIER

Maximum Ratings, (Design-Center Values):	
PEAK INVERSE PLATE VOLTAGE	1550
PEAK PLATE CURRENT (Per Plate)	750
HOT-SWITCHING TRANSIENT PLATE CURRENT (Per Plate) maximum duration 0.2 second	4
AC PLATE SUPPLY VOLTAGE (Per Plate, rms)	See Rating Chart
DC OUTPUT CURRENT	See Rating Chart

Typical Operation:

Filter Input	Capacitor	Choke
AC Plate-to-Plate Supply Voltage (rms)	900	1100
Filter-Input Capacitor	10	—
Effective Plate Supply Impedance per Plate	153	—
Filter-Input Choke	—	10
DC Output Current	250	250
DC Output Voltage at Input to Filter (Approx.)	422	440
Characteristics, Instantaneous Value:		
Tube Voltage Drop for plate current of 250 ma (per plate)	—	50

RATING CHART

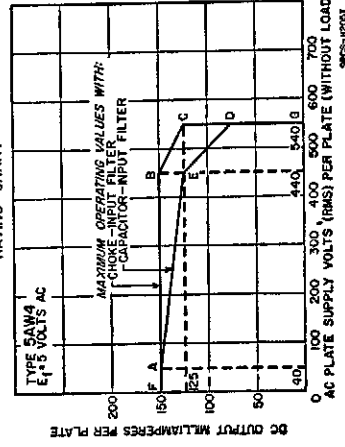

FULL-WAVE VACUUM RECTIFIER

Lock-in type used in power supply of radio equipment having moderate dc requirements. Outline 13B, OUTLINES SECTION. Tube requires lock-in socket. Filament volts (ac), 5.0; amperes, 2.0. Maximum ratings as full-wave rectifier: peak inverse plate volts, 1400 max; peak plate ma. (per plate), 375 max; dc output ma., 125 max. This type is used principally for renewal purposes.

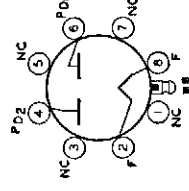

Typical Operation:

Filter Input	Capacitor	Choke
AC Plate-to-Plate Supply Voltage (rms)	700	1000
Filter-Input Capacitor	4	—
Total Effective Plate-Supply Impedance Per Plate	50	—
Filter-Input Choke	—	5

DC Output Current	Filter Input	Choke	ma
DC Output Voltage at Input to Filter (Approx.):	125	125	
At half-load current (62.5 ma.)	392.5	405	volts
At full-load current (125 ma.)	340	382	volts
Voltage Regulation (Approx.):	52.5	23	volts

† When a filter-input capacitor larger than 40 μ . is used, it may be necessary to use more plate-supply impedance than the value shown in order to limit the peak plate current to the rated value.

5B8 MEDIUM-MU TRIODE— SHARP-CUTOFF PENTODE

Miniature type used as combined vhf oscillator and mixer in television receivers employing series-connected heater strings. Outline 8B, OUTLINES SECTION. Tube requires miniature nine-contact socket and may be mounted in any position. Heater volts (ac/dc), 4.7; amperes, 0.6; warm-up time (average), 11 seconds.

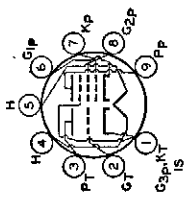

CLASS A₁ AMPLIFIER

Maximum Ratings, (Design-Center Values):	Triode Unit	Pentode Unit
Plate Voltage	800 maz	800 maz
Grid-No.2 (SCREEN-GRID) SUPPLY VOLTAGE	—	800 maz
Grid-No.2 VOLTAGE	—	See curve page 70
Grid-No.1 (CONTROL-GRID) VOLTAGE, Positive-bias value	0 maz	0 maz
Plate Dissipation	2.5 maz	2 maz
Grid No.2 Input:	—	0.5 maz
For grid-No.2 voltages up to 150 volts	—	See curve page 70
For grid-No.2 voltages between 150 and 300 volts	200 maz	200 maz
PEAK HEATER-CATHODE VOLTAGE:	200 maz	200 maz
Heater negative with respect to cathode	—	—
Heater positive with respect to cathode	—	—
Characteristics:		
Plate Supply Voltage	200	200
Grid-No.2 Supply Voltage	—	150
Grid Voltage	—	180
Cathode-Bias Resistor	19	—
Amplification Factor	5750	800000
Plate Resistance (Approx.)	8300	6200
Transconductance	13	9.5
Plate Current	—	2.8
Grid-No.2 Current	—	—
Grid-No.1 Voltage (Approx.) for plate current of 10 μ a.	-19	-8
Maximum Circuit Voltages:		
Grid-No.1-Circuit Resistance*	0.5 maz	0.25 maz
For fixed-bias operation	1.0 maz	1.0 maz
For cathode-bias operation	—	—

* The dc component must not exceed 100 volts.
* If either unit is operated at maximum rated conditions, grid-No.1-circuit resistance for both units should not exceed the stated values.

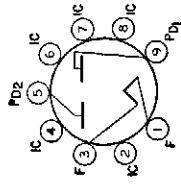

5B8 FULL-WAVE VACUUM RECTIFIER

Novar type used in power supplies of radio equipment and television receivers having high dc requirements. Outline 17B, OUTLINES SECTION. Tube requires novar nine-contact socket. Vertical operation is preferred, but tube may be operated in horizontal position if pins 2 and 7 are in vertical plane. It is especially important that this tube, like other power-handling tubes, be adequately ventilated. Filament volts (ac), 5; amperes, 3.

FULL-WAVE RECTIFIER

Maximum Ratings, (Design-Maximum Values):			
PEAK INVERSE PLATE VOLTAGE	1700 maz	volts	
PEAK PLATE CURRENT (Per Plate)	1 maz	amperes	
HOT-SWITCHING TRANSIENT PLATE CURRENT (Per Plate)*	5 maz	amperes	
AC PLATE-SUPPLY VOLTAGE (Per Plate, rms)	See Rating Chart		
DC OUTPUT CURRENT (Per Plate)	See Rating Chart		

Typical Operation with Capacitor Input to Filter:

AC Plate-to-Plate Supply Voltage (rms)	600	900	1100	volts
Filter-Input Capacitor ^m	40	40	40	μ f
Total Effective Plate-Supply Impedance per Plate	21	67	97	ohms
DC Output Voltage at Input to Filter (Approx.):	290	—	—	volts
At load current of:				
275 ma.	—	460	—	volts
162 ma.	—	—	580	volts
150 ma.	835	—	—	v ¹ g
137.5 ma.	—	520	—	v ¹ g
81 ma.	—	—	680	volts

Typical Operation with Choke Input to Filter:

AC Plate-to-Plate Supply Voltage (rms)	900	1100	volts
Filter-Input Choke	10	10	henries
DC Output Voltage at Input to Filter (Approx.):			
At load current of:			
348 ma.	340	—	volts
275 ma.	—	440	volts
174 ma.	—	355	volts
137.5 ma.	—	465	volts

* If hot switching is regularly required in operation, the use of choke-input circuits is recommended. Such circuits limit the hot-switching current to a value no higher than that of the peak plate current. When capacitor-input circuits are used, a maximum peak current value per plate of 5 amperes during the initial cycles of the hot-switching transient should not be exceeded.
† Higher values of capacitance than indicated may be used, but the effective plate-supply impedance may have to be increased to prevent exceeding the maximum rating for peak plate current.

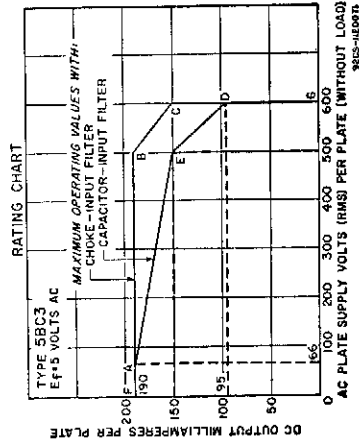

5BE8 MEDIUM-MU TRIODE— SHARP-CUTOFF PENTODE

Miniature type used as combined vhf mixer and oscillator tube in television receivers employing series-connected heater strings. Outline 8B, OUTLINES SECTION. Tube requires miniature nine-contact socket. Heater volts (ac/dc), 4.7; amperes, 0.6; warm-up time (average), 11 seconds. Characteristics of triode unit as class A₁ amplifier: plate supply voltage, 150 (300 maz); cathode-bias resistor, 56 ohms; amplification factor, 40; plate resistance (approx.), 5000 ohms; transconductance, 8500 μ mhos; plate ma., 18; plate dissipation, 2.5 maz watts. Pentode unit: plate supply voltage, 250 (300 maz); grid-No.2 supply volts, 110 (300 maz); cathode-bias resistor, 68 ohms; plate resistance (approx.), 0.4 megohm; transconductance, 5200 μ mhos; plate ma., 10; grid-No.2 ma., 3.5; plate dissipation, 2.8 maz watts; grid-No.2 input, 0.5 maz watt. This type is used principally for renewal purposes.

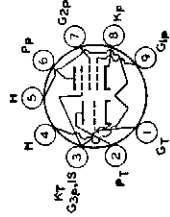

MEDIUM-MU TWIN TRIODE

Miniature type used in direct-coupled cathode-drive rf amplifier circuits of vhf television tuners utilizing series-connected heater strings. Outline 8B, OUTLINES SECTION.

Heater volts (ac/dc), 4.7; amperes, 0.6; warm-up time (average), 11 seconds. Except for heater ratings, this type is identical with miniature type 6BK7-B.

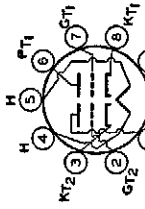

5BK7A

Related types:
6BK7A

MEDIUM-MU TWIN TRIODE

Miniature type used in direct-coupled cathode-drive rf amplifier circuits of vhf television tuners employing series-connected heater strings. Outline 8B, OUTLINES SECTION.

Heater volts (ac/dc), 5.6; amperes, 0.45; warm-up time (average), 11 seconds. Except for heater ratings, this type is identical with miniature type 6BQ7-A.

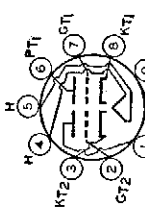

5BQ7A

Related types:
4BQ7A, 6BQ7A

**MEDIUM-MU TRIODE—
SHARP-CUTOFF PENTODE**

Miniature type used in a wide variety of applications in color and black-and-white television receivers employing series-connected heater strings. Outline 8B, OUTLINES SECTION.

Heater volts (ac/dc), 4.7; amperes, 0.6; warm-up time (average), 11 seconds. Except for heater ratings, this type is identical with miniature type 6BR8-A.

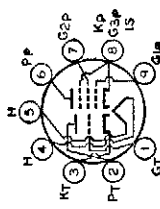

5BR8

Related types:
6BR8A

**TWIN DIODE—
SHARP-CUTOFF PENTODE**

Miniature type used in a variety of applications in television receivers employing series-connected heater strings. The pentode unit is used as an if amplifier, video amplifier, agc amplifier, or reactance tube. The diode unit is used in automatic-frequency-control and detector circuits. Outline 8B, OUTLINES SECTION.

Heater volts (ac/dc), 4.7; amperes, 0.6; warm-up time (average), 11 seconds. Tube requires miniature nine-contact socket. Characteristics of pentode unit as class A1 amplifier: plate supply volts, 200 (300 max.); grid-No.2 supply volts, 150 (300 max.); cathode-bias resistor, 180 ohms; plate resistance (approx.), 0.3 megohm; transconductance, 6200 μ mhos; plate m.a., 9.5; grid-No.2 m.a., 2.3; plate dissipation, 2 m.w. watt; grid-No.2 input, 0.5 m.w. watt. Maximum diode plate m.a. (each unit), 1 m.w. This type is used principally for renewal purposes.

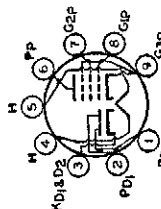

5BT8

**TWIN DIODE—
SHARP-CUTOFF PENTODE**

Miniature type used in television receivers employing series-connected heater strings. The pentode unit is used as a sound if amplifier, sound limiter, and agc keyer. The diodes are used as horizontal phase detectors. Outline 8B, OUTLINES SECTION. Heater

volts (ac/dc), 4.7; amperes, 0.6; warm-up time (average), 11 seconds. Except for heater ratings, this type is identical with miniature type 6BW8.

5BW8

Related types:
6BW8

**MEDIUM-MU TRIODE—
SHARP-CUTOFF PENTODE**

Miniature type used as combined oscillator and mixer tube in television receivers employing series-connected heater strings. Outline 8B, OUTLINES SECTION. Heater volts (ac/dc), 4.7; amperes, 0.6; warm-up time (average), 11 seconds. Except for heater ratings, this type is identical with miniature type 6CG8-A.

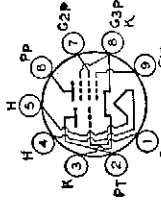

5CG8

Related types:
6CG8

**MEDIUM-MU TRIODE—
SHARP-CUTOFF TETRODE**

Miniature types used as combined vhf oscillator and mixer in television receivers employing series-connected heater strings. Outline 8B, OUTLINES SECTION. Heater volts (ac/dc), 4.7; amperes, 0.6; warm-up time (average), 11 seconds. Except for heater ratings, types 5CL8 and 5CL8-A are identical with miniature types 6CL8 and 6CL8-A, respectively. Type 5CL8 is a DISCONTINUED type listed for reference only.

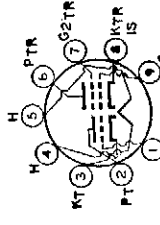

5CL8

5CL8A

Related types:
6CL8A, 19CL8A

**HIGH-MU TRIODE—
SHARP-CUTOFF PENTODE**

Miniature type used in television receivers employing series-connected heater strings. The pentode unit is used as an intermediate-frequency amplifier, a video amplifier, an agc amplifier, or as a reactance tube. The triode unit is used in sweep-oscillator, sync-separator, sync-clipper, and phase-splitter circuits. Outline 8B, OUTLINES SECTION. Heater volts (ac/dc), 4.7; amperes, 0.6. Except for heater ratings, this type is identical with miniature type 6CM8.

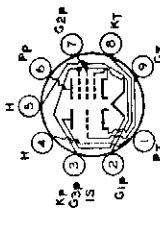

5CM8

Related types:
6CM8

**MEDIUM-MU TRIODE—
SHARP-CUTOFF TETRODE**

Miniature type used in a wide variety of applications in color and black-and-white television receivers employing series-connected heater strings. The tetrode unit is used as a mixer or amplifier and the triode unit is used in oscillator and rf amplifier circuits. Outline 8B, OUTLINES SECTION. Heater volts (ac/dc), 4.7; amperes, 0.6; warm-up time (average), 11 seconds. Except for heater ratings, this type is identical with miniature type 6CQ8.

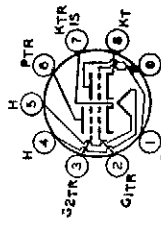

5CQ8

Related types:
6CQ8

BEAM POWER TUBE

Miniature type used as vertical deflection amplifier and as audio output tube in television and radio receivers employing series-connected heater strings. Outline 8E, OUTLINES SECTION. Heater volts (ac/dc), 4.7; amperes, 0.6; warm-up time (average), 11 seconds. Except for heater ratings, this type is identical with miniature type 6CZ5.

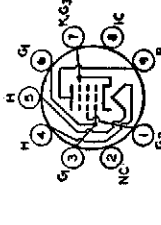

5CZ5

Related types:
6CZ5

HIGH-MU TRIODE— SHARP-CUTOFF PENTODE

5DH8 Miniature type used in television receivers having series-connected heater strings. Pentode used as video or audio if amplifier; triode used as sync amplifier, sync clipper, sync separator, or vertical oscillator. Outline 8B, OUTLINES SECTION. Tube requires miniature nine-contact socket and may be operated in any position. Heater volts (ac/dc), 5.2; amperes, 0.6; heater warm-up time (average), 11 seconds.

CLASS A₁ AMPLIFIER

Maximum Ratings, (Design-Maximum Values):	Triode Unit	Pentode Unit
PLATE VOLTAGE	300 max	300 max
GRID-NO.2 (SCREEN-GRID) SUPPLY VOLTAGE	—	See curve page 70
GRID-NO.2 VOLTAGE	—	See curve page 70
GRID-NO.1 (CONTROL-GRID) VOLTAGE, Positive-bias value	0 max	0 max
PLATE DISSIPATION	2.0 max	2.2 max
GRID-NO.2 INPUT	—	0.55 max
For grid-No.2 voltages up to 150 volts.	—	See curve page 70
For grid-No.2 voltages between 150 and 300 volts.	200 max	200 max
PEAK HEATER-CATHODE VOLTAGE:	200 max	200 max
Heater negative with respect to cathode.	—	—
Heater positive with respect to cathode.	—	—

Characteristics:

	Triode Unit	Pentode Unit
Plate Supply Voltage	250	125
Grid-No.2 Supply Voltage	390	125
Cathode-Bias Resistor	7.3	36
Plate Current	—	18.3
Grid-No.2 Current	52	3.5
Amplification Factor	0.012	0.15
Plate Resistance (Approx.)	410	8600
Transconductance	-10	-6
For plate current of 10 μ a.	—	—
For plate current of 20 μ a.	—	—

Maximum Circuit Values:

Grid-No.1-Circuit Resistance:	0.5 max	0.25 max
For fixed-bias operation:	0.1 max	1.0 max
For cathode-bias operation:	—	—

VERTICAL DEFLECTION OSCILLATOR

For operation in a 585-line, 30-frame system

Maximum Ratings, (Design-Maximum Values):

DC PLATE VOLTAGE	300 max	Triode Unit
PEAK NEGATIVE-PULSE GRID VOLTAGE	400 max	300 max
PEAK CATHODE CURRENT	35 max	400 max
AVERAGE CATHODE CURRENT	12 max	35 max
PLATE DISSIPATION	1 max	12 max
PEAK HEATER-CATHODE VOLTAGE:	—	1 max
Heater negative with respect to cathode.	200 max	200 max
Heater positive with respect to cathode.	200 ^o max	200 ^o max

Maximum Circuit Values:

Grid Circuit Resistance:	2.2 max	megohms
For fixed-bias, cathode-bias, or grid-resistor-bias operation:	—	—
The dc component must not exceed 100 volts.	—	—

FULL-WAVE VACUUM RECTIFIER

5DJ4 Glass octal type used in power supply of radio and television receivers having high dc requirements. Outline 19D, OUTLINES SECTION, Tube requires octal socket; operation in vertical position is preferred, but horizontal operation is permissible if pins 2 and 4



are in vertical plane. It is especially important that this tube, like other power-handling tubes, be adequately ventilated. Filament volts (ac/dc), 5; amperes, 3.

FULL-WAVE RECTIFIER

Maximum Ratings, (Design-Maximum Values):

PEAK INVERSE PLATE VOLTAGE	1700 max	volts
PEAK PLATE CURRENT (Per Plate)	1.7 max	ampere
HOT-SWITCHING TRANSIENT PLATE CURRENT (Per Plate)	—	ampere
AC PLATE-SUPPLY VOLTAGE (Per Plate, rms, without load)	—	volts
DC OUTPUT CURRENT (Per Plate)	—	See Rating Chart

Typical Operation:

Filter Input	Capacitor	Choke
AC Plate-to-Plate Supply Voltage (rms, without load)	600	900
Filter-Input Capacitor	40	40
Filter-Input Choke	—	10
Effective Plate-Supply Impedance Per Plate	21	67
DC Output Voltage at Input to Filter (Approx.)	290	460
DC Output Current	300	275

When capacitor values greater than 40 μ f are used, the effective plate-supply impedance should be increased so that the maximum rating for peak plate current is not exceeded.

RATING CHART

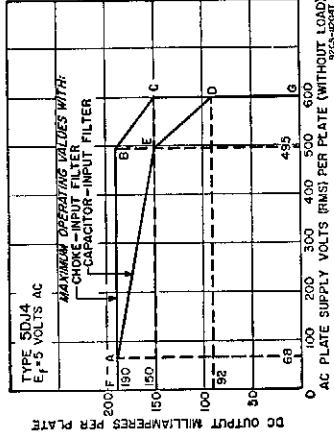

MEDIUM-MU TRIODE— SHARP-CUTOFF PENTODE

5EA8 Miniature type used as combined oscillator and mixer in television receivers employing series-connected heater strings and operating at intermediate frequencies in the order of 40 megacycles. Outline 8B, OUTLINES SECTION. Heater volts (ac/dc), 4.7; amperes, 0.6; warm-up time (average), 11 seconds. Except for heater ratings, this type is identical with miniature type 6EA8.

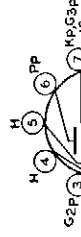

MEDIUM-MU TRIODE— SHARP-CUTOFF PENTODE

5EU8 Miniature type used as combined oscillator and mixer in television receivers employing series-connected heater strings. Outline 8B, OUTLINES SECTION. Heater volts (ac/dc), 4.7; amperes, 0.6; warm-up time (average), 11 seconds. Cathode warm-up time (time required for the transconductance to reach 6500 μ mhos when the tube is operated from a cold start with dc plate volts=100, grid volts=0, and heater amperes=0.560), 35 seconds. Except for heater ratings and cathode warm-up characteristic, this type is identical with miniature type 6EU8.

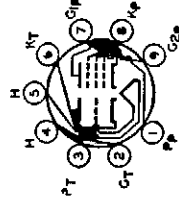

5EW6

Related types:
4EW6, 6EW6

SHARP-CUTOFF PENTODE

Miniature type used in the gain-controlled picture-if stages of vhf television receivers operating at an intermediate frequency in the order of 40 megacycles per second. Outline 7B, OUTLINES SECTION. Heater volts (ac/dc), 5.6; amperes, 0.45; warm up time (average), 11 seconds. Except for heater ratings, this type is identical with miniature type 6EW6.

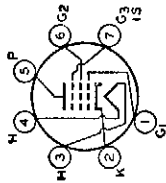

5FG7

Related types:
6FG7

MEDIUM-MU TRIODE — SHARP-CUTOFF PENTODE

Miniature type used as combined oscillator and mixer tube in vhf television receivers employing series-connected heater strings. Outline 8B, OUTLINES SECTION. Heater volts (ac/dc), 4.7; amperes, 0.6; warm-up time (average), 11 seconds. Except for heater ratings, this type is identical with miniature type 6FG7.

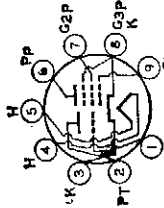

MEDIUM-MU TRIODE — SHARP-CUTOFF PENTODE

Miniature type used as combined vertical deflection oscillator and general-purpose or if amplifier in television receivers employing series-connected heater strings. Outline 8B, OUTLINES SECTION. Heater volts (ac/dc), 4.7; amperes, 0.6; warm-up time (average), 11 seconds. Except for heater ratings, this type is identical with miniature type 6FV8.

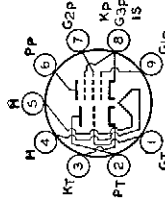

5GH8

Related types:
6GH8

MEDIUM-MU TRIODE — SHARP-CUTOFF PENTODE

Miniature type used in multi-vibrator-type horizontal-deflection circuits in television receivers employing a series heater-string arrangement. Also used for age-amplifier or sync-separator applications in such receivers. Outline 8B, OUTLINES SECTION. Heater volts (ac/dc), 4.7; amperes, 0.6; warm-up time (average), 11 seconds. Except for heater ratings, this type is identical with miniature type 6GH8.

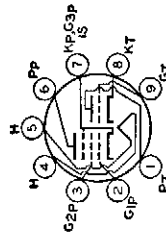

5GM6

Related types:
6GM6

SEMIREMOTE-CUTOFF PENTODE

Miniature type used in gain-controlled picture-if stages of television receivers employing series-connected heater strings and operating at intermediate frequencies in the order of 40 megacycles. Outline 7B, OUTLINES SECTION. Heater volts (ac/dc), 5.6; amperes, 0.5; warm-up time (average), 11 seconds. Except for heater ratings, this type is identical with miniature type 6GM6.

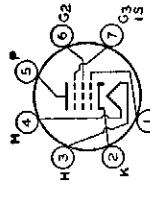

5GX6

Related types:
6GX6

SHARP-CUTOFF PENTODE

Miniature type used for FM sound-detector service in locked-oscillator, quadrature-grid FM detector circuits, as combined detector, limiter, and audio-voltage driver. Tube has two independent control grids, and has controlled heater warm-up time for use in receivers employing series-connected heater strings. Outline 7B, OUTLINES SECTION. Heater volts (ac/dc), 4.7; amperes, 0.6; warm-up time (average), 11 seconds. Except for heater ratings, this type is identical with miniature type 6GX6.

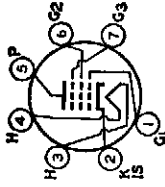

MEDIUM-MU TWIN TRIODE

Miniature type used as combined rf power amplifier and oscillator in television receivers employing series-connected heater strings. Outline 7B, OUTLINES SECTION. Heater volts (ac/dc), 4.7; amperes, 0.6; warm-up time (average), 11 seconds. Except for heater ratings, this type is identical with miniature type 6J6.

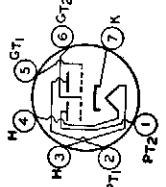

5J6

Related types:
6J6, 19J6

MEDIUM-MU TRIODE — SHARP-CUTOFF PENTODE

Miniature type with frame-grid pentode unit used as combined oscillator-mixer tube in television receivers using an intermediate frequency in the order of 40 megacycles and employing series-connected heater strings. Outline 8B, OUTLINES SECTION. Heater volts (ac/dc), 5.6; amperes, 0.45; warm-up time (average), 11 seconds. Except for heater ratings, this type is identical with miniature type 6KE8.

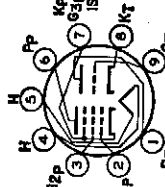

5KE8

Related types:
6KE8

FULL-WAVE VACUUM RECTIFIER

Metal type used in power supply of radio equipment having large dc requirements. Outline 6, OUTLINES SECTION. Tube requires octal socket. Vertical tube mounting is preferred but horizontal mounting is permissible if pins 2 and 4 are in vertical plane. Filament volts (ac), 5.0; amperes, 2.0. Maximum ratings as full-wave rectifier: peak inverse plate volts, 1550 max; peak plate ma. (per plate), 675 max; dc output ma., 225 max. This type is used principally for renewal purposes.

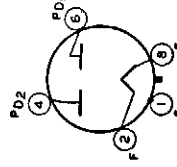

5T4

Typical Operation:

Filter Input	Capacitor	Choke
AC Plate-to-Plate Supply Voltage (rms)	900	1100
Filter-Input Capacitor	4	
Total Effective Plate-Supply Impedance Per Plate†	150	
Filter-Input Choke	—	10
DC Output Current	225	225
DC Output Voltage at Input to Filter (Approx.):		
At half-load current (112.5 ma.)	539	465
At full-load current (225 ma.)	480	450
Voltage Regulation (Approx.):		
Half-load to full-load current	59	15

†When a filter-input capacitor larger than 40 μ f is used, it may be necessary to use more plate-supply impedance than the value shown in order to limit the peak plate current to this rated value.

FULL-WAVE VACUUM RECTIFIER

Glass octal types used as power supply in color television receivers and other equipment having high dc requirements. Outline 19D, OUTLINES SECTION. Tubes require octal socket.

**5V3
5V3A**

Vertical mounting is preferred, but horizontal mounting is permissible if pins 2 and 4 are in vertical plane. It is especially important that these tubes, like other power-handling tubes, be adequately ventilated. For discussion of Rating Chart, refer to INTERPRETATION OF TUBE DATA. Type 5V3 is a DISCONTINUED type listed for reference only. Filament volts (ac/dc), 5; amperes, 3.8 (5V3), 3 (5V3-A).

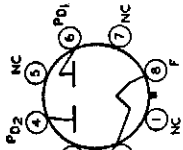

FULL-WAVE RECTIFIER

5V3	5V3-A
Design-Center Values	Design-Center Values
1400 maz	1550 maz
Peak Inverse Plate Voltage	Peak Inverse Plate Voltage
1.2 maz	1.4 maz
Peak Plate Current (Per Plate)	Peak Plate Current (Per Plate)
5.5 maz	6.6 maz
DC Plate-Supply Voltage (Per Plate, without load)	DC Plate-Supply Voltage (Per Plate, without load)
550 maz	550 maz
DC Output Current (Per Plate)	DC Output Current (Per Plate)
415-maz	415-maz

With capacitor-input filter for ac plate-supply volts (rms, per plate, without load) = 470.

Typical Operation:

Filter Input	5V3	5V3-A
AC Plate-to-Plate Supply Voltage (rms)	850 1000	850 1000
Filter-Input Capacitor	40	40
Effective Plate-Supply Impedance per Plate	56	56
Minimum Filter-Input Choke	10	10
DC Output Current	350 350	350 350
DC Output at Input to Filter (Approx.)	430 385	440 390

Characteristics:

Tube Voltage Drop for plate current of 850 ma (per plate) ... 47 volts
When capacitor values greater than 40 µf are used, the effective plate-supply impedance should be increased so that the maximum rating for peak plate current is not exceeded.

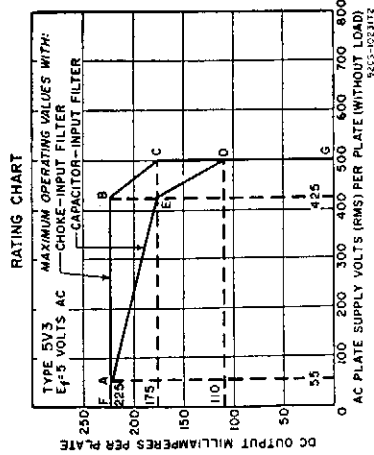

**5V4G
5V4GA**

FULL-WAVE VACUUM RECTIFIER

Glass octal types used in full-wave power supplies having high dc requirements. Outlines 26 and 19A, respectively, OUTLINES SECTION. Tubes require octal socket and may be mounted in any position. The heater is designed to operate from the ac line through a step-down transformer. The voltage at the heater terminals should be 5.0 volts

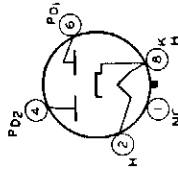

under operating conditions at an average line voltage of 117 volts. It is especially important that these tubes, like other power-handling tubes, be adequately ventilated. Heater volts (ac/dc), 5; amperes, 2.

FULL-WAVE RECTIFIER

Maximum Ratings, (Design-Center Values):

Peak Inverse Plate Voltage	1400 maz	volts
AC Plate-Supply Voltage (Per Plate, rms)	875 maz	volts
With capacitor-input filter	500 maz	volts
With choke-input filter	525 maz	volts
Peak Plate Current (Per Plate)	175 maz	ma
DC Output Current		ma

Typical Operation:

Filter Input	Capacitor
AC Plate-to-Plate Supply Voltage (rms)	750
Filter-Input Capacitor	1000
Total Effective Plate-Supply Impedance per Plate	10
Filter-Input Choke	100
DC Output Voltage at Input to Filter (Approx.) for dc output current of 175 ma	410

*Higher values of capacitance than indicated may be used, but the effective plate-supply impedance may have to be increased to prevent exceeding the maximum rating for peak plate current.

OPERATION CHARACTERISTICS

FULL-WAVE RECTIFIER CIRCUIT

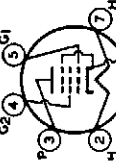
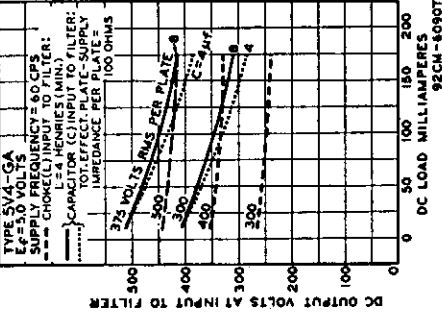

BEAM POWER TUBE

Glass octal type used as output amplifier in television receivers employing series-connected heater strings. Outline 14C, OUTLINES SECTION. This type may be supplied with pin No.1 omitted. Heater volts (ac/dc), 4.7; amperes, 0.6; warm-up time (average), 11 seconds. Except for heater ratings, this type is identical with glass octal type 6V6-GT.

5V6GT
Related types:
6V6GT, 12V6GT

FULL-WAVE VACUUM RECTIFIER

Metal type 5W4 and glass-octal type 5W4-GT are used in power supply of radio equipment having low dc requirements. Outlines 5 and 14D, respectively, OUTLINES SECTION. Both types require octal socket. Filament volts (ac), 5.0; amperes, 1.5. Maximum ratings: peak inverse plate volta, 1400 maz; peak plate ma., 300 maz; dc output ma., 100 maz. These are DISCONTINUED types listed for reference only.

**5W4
5W4GT**

5X4G

FULL-WAVE VACUUM RECTIFIER

Glass octal type used in power supply of radio equipment having large dc requirements. Maximum dimensions: over-all length, 5-5/16 inches; seated height, 4-3/4 inches; diameter, 2-1/16 inches. Filament volts, 5.0; amperes, 3.0. Tube requires octal socket. Maximum ratings as full-wave rectifier: peak inverse plate volts, 1550 *max.*; peak plate amperes per plate, 675 *max.* Type 5X4-G is used principally for renewal purposes.

MEDIUM-MU TRIODE—SHARP-CUTOFF PENTODE

Miniature type used as combined oscillator and mixer in AM/FM receivers and television receivers employing series-connected heater strings. Outline 8B, OUTLINES SECTION.

Heater volts (ac/dc), 4.7; amperes, 0.6; warm-up time (average), 11 seconds. Except for heater rating, this type is identical with miniature type 6X8.

5X8

Related types:
6X8, 19X8

5Y3G

5Y3GT

octal socket. Vertical tube mounting is permissible if pins 2 and 8 are in horizontal plane. It is especially important that these tubes, like other power-handling tubes, be adequately ventilated. For discussion of Rating Chart and Operation Characteristics, refer to INTERPRETATION OF TUBE DATA. Maximum ratings for type 5Y3-G as full-wave rectifier: peak inverse plate volts, 1400 *max.*; peak plate ma. per plate, 875 *max.* Type 5Y3-G is a DISCONTINUED type listed for reference only. Filament volts (ac), 5; amperes, 2.

FULL-WAVE RECTIFIER

Maximum Ratings, (Design-Center Values):
 PEAK INVERSE PLATE VOLTAGE..... volts
 PEAK PLATE CURRENT (Per Plate)..... ma
 HOT-SWITCHING TRANSIENT PLATE CURRENT (Per Plate)..... amperes
 AC PLATE SUPPLY VOLTAGE (Per Plate, rms)..... See Rating Chart
 DC OUTPUT CURRENT (Per Plate)..... See Rating Chart

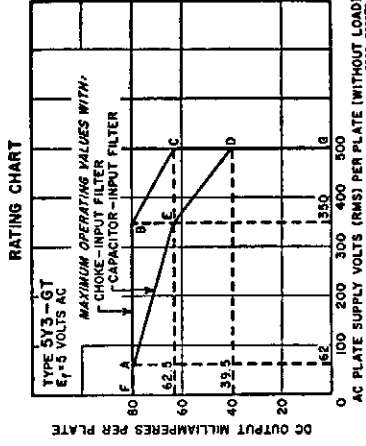

Typical Operation of 5Y3-GT with Capacitor Input to Filter:

AC Plate-to-Plate Supply Voltage (rms).....	700	1000	volts
Filter Input Capacitor*.....	20	10	μ f
Effective Plate-Supply Impedance per Plate.....	50	140	ohms
DC Output Voltage at Input to Filter (Approx.):			
At half-load current of 62.5 ma.....	380	—	volts
At full-load current of 125 ma.....	360	—	volts
At full-load current of 84 ma.....	—	50	volts

Typical Operation of 5Y3-GT with Choke Input to Filter:

AC Plate-to-Plate Supply Voltage (rms).....	700	1000	volts
Filter Input Choke#.....	10	10	henries
DC Output Voltage at Input to Filter (Approx.):			
At half-load current of 75 ma.....	270	—	volts
At full-load current of 150 ma.....	245	—	volts
At full-load current of 125 ma.....	—	380	volts
At full-load current of 25 ma.....	—	15	volts

* Higher values of capacitance than indicated may be used but the effective plate supply impedance may have to be increased to prevent exceeding the maximum rating for hot-switching transient plate current.

This value is adequate to maintain optimum regulation in the region to the right of line L=10H on curve OPERATION CHARACTERISTICS with Choke Input to Filter, provided the load currents are not less than 35 ma., and 50 ma., respectively, for Plate-to-Plate supply voltages of 700 and 1000 volts (rms).

OPERATION CHARACTERISTICS

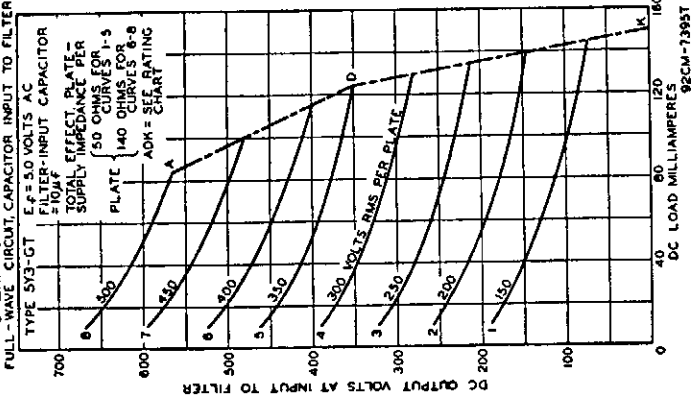

OPERATION CHARACTERISTICS

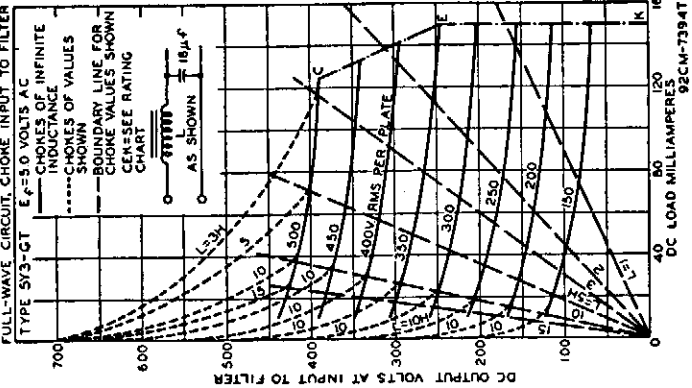

FULL-WAVE VACUUM RECTIFIER

Glass octal types used in power supplies of radio equipment having moderate DC requirements. Outlines 26, 14D, and 19D, respectively, OUTLINES SECTION. Tubes require octal socket. Type 5Y4GT is supplied

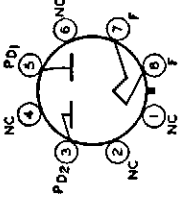

with pins 4 and 6 missing. Vertical tube mounting is preferred, but horizontal mounting is permissible: if pins 2 and 7 are in horizontal plane (5Y4-G); if pins 1 and 4 are in vertical plane (5Y4-GA); if pins 2 and 3 are in vertical plane (5Y4-GT). It is especially important that these tubes, like other power handling tubes, be adequately ventilated. For discussion of Rating Chart, refer to INTERPRETATION OF TUBE DATA. Maximum ratings for type 5Y4-G as full-wave rectifier: peak inverse plate volts, 1400 *max*; peak plate ma. per plate, 375 *max* (transient amperes, 2.2 *max*). Type 5Y4-G is a DISCONTINUED type listed for reference only. Filament volts (ac/dc), 5; amperes, 2.

FULL-WAVE RECTIFIER

Maximum Ratings, (Design-Center Value):

PEAK INVERSE PLATE VOLTAGE	1400 <i>max</i>	volts
PEAK PLATE CURRENT (Per Plate)	400 <i>max</i>	ma
HOT-SWITCHING TRANSIENT PLATE CURRENT	2.2 <i>max</i>	amperes
AC PLATE SUPPLY VOLTAGE (Per Plate, RMS)	See Rating Chart	
DC OUTPUT CURRENT (Per Plate)	See Rating Chart	

Typical Operation of 5Y4-GA & 5Y4-GT:

Filter Input		Capacitor	Choke
AC Plate-to-Plate Supply Voltage (rms)	700	700	1000
Filter Input Capacitor	10	10	—
Total Effective Plate-Supply Impedance per Plate	50	—	—
Filter-Input Choke	—	10	10
DC Output Current	125	125	125
DC Output Voltage at Input to Filter (Approx.):	350	350	390
At full-load current (125 ma.)			

Characteristics, Instantaneous Value:

Tube Voltage Drop for plate current of 125 ma (per plate). 60 volts
 ° Values of capacitance greater than 20 μ f may be used, provided the plate-supply impedance is increased to prevent exceeding the maximum peak-plate-current rating.

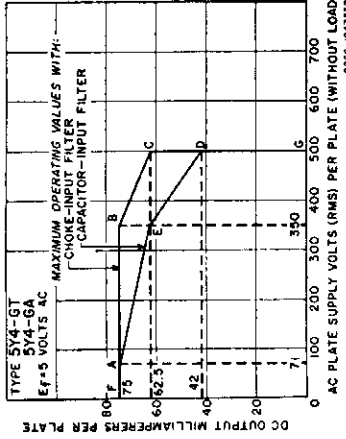

FULL-WAVE VACUUM RECTIFIER

Glass type used in power supply of radio equipment having large dc requirements. Outline 28, OUTLINES SECTION. Tube requires four-contact socket. Vertical mounting is preferred but horizontal mounting is permissible if pins 1 and 4 are in horizontal plane. Filament volts (ac), 5.0; amperes, 3.0. Maximum ratings as full-wave rectifier: peak inverse plate volts, 1650 *max*; peak plate ma. per plate, 675 *max*. Type 5Z3 is used principally for renewal purposes.

FULL-WAVE VACUUM RECTIFIER

Metal type used in power supply of radio equipment having moderate dc requirements. Outline 5, OUTLINES SECTION. Tube requires octal socket and may be mounted in

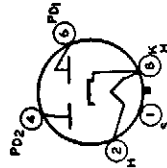
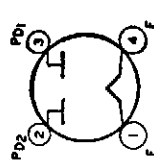

5Z3

5Z4

any position. Heater volts (ac), 5.0; amperes, 2.0. Maximum ratings: peak inverse plate volts, 1400 *max*; peak plate ma. per plate, 375 *max*. Typical operation as full-wave rectifier with capacitor-input filter: ac plate-to-plate supply volts (rms), 700; total effective plate-supply impedance per plate, 50 ohms; dc output ma., 125. Typical operation with choke-input filter: ac plate-to-plate supply volts, 1000; minimum filter-input choke, 5 henries; dc output ma., 125.

POWER TRIODE

Glass type used in output stage of radio receivers. Outline 28, OUTLINES SECTION. Tube requires four-contact socket. Filament volts (ac/dc), 6.3; amperes, 1.0. This type is identical electrically with type 6B4-G. Type 6A3 is a DISCONTINUED type listed for reference only.

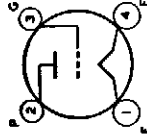

6A3

HIGH-MU TWIN POWER TRIODE

Glass type used in output stage of ac-operated receivers as a class B power amplifier or with units in parallel as a class A₁ amplifier to drive a 6A6 as class B amplifier. Outline 27, OUTLINES SECTION. Tube requires medium seven-contact (0.856-inch, pin-circle diameter) socket. Filament volts (ac/dc), 6.3; amperes, 0.8. This type is electrically identical with type 6N7. Type 6A6 is a DISCONTINUED type listed for reference only.

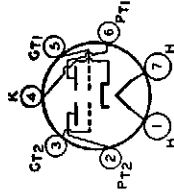

6A6

PENTAGRID CONVERTER

Glass types used in superheterodyne circuits. Outline 24B, OUTLINES SECTION. These types require the small seven-contact (0.775-inch, pin-circle diameter) socket. Except for interelectrode capacitances, the 6A7 is identical electrically with type 6A8. Type 6A75, now DISCONTINUED, has the external shield connected to cathode. In general, its electrical characteristics are similar to those of the 6A7, but the two types are usually not directly interchangeable. Type 6A75 is used principally for renewal purposes.

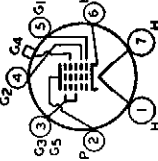

6A7

6A75

PENTAGRID CONVERTER

Metal type 6A8 and glass octal types 6A8-G and 6A8-GT used in superheterodyne circuits. 6A8 Outline 3, 6A8-G Outline 23, 6A8-GT Outline 15A, OUTLINES SECTION. Tubes require octal socket. Heater volts (ac/dc), 6.3; amperes, 0.3. Characteristics as converter: plate and grid-No.2-supply volts, 250 (300 *max*); grids-No.3-and-No.5 (screen-grid) volts, 100 *max*; grid-No.4 (control-grid) volts, -3 (0 *max*); grid-No.2 (anode-grid) resistor, 20000 ohms (bypassed by 0.1- μ f capacitor); grid-No.1 (oscillator-grid) resistor, 50000 ohms; plate resistances (approx.), 0.36 megohm; conversion transconductance, 550 μ mhos; plate ma., 3.5; grids-No.3-and-No.5 ma., 2.7; grid-No.2 ma., 4; grid-No.1 ma., 0.4; total cathode input, 10.6 (14 *max*); plate dissipation, 1 *max* watt; grid-No.3-and-No.5 input, 0.3 *max* watt; grid-No.2 input, 0.75 *max* watt; peak heater-cathode volts, 90 *max*. These types are used principally for renewal purposes.

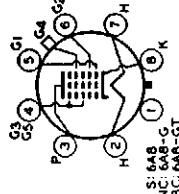

6A8

6A8G

6A8GT

Related types:
12A6GT

HIGH-MU TRIODE

Miniature type used as cathode-drive amplifier, frequency converter, or oscillator at frequencies up to about 300 megacycles per second particularly in television and FM receivers. Outline 7B, OUTLINES SECTION. Tube requires miniature seven-contact socket and may be mounted in any position. Heater volts (ac/dc), 6.3; amperes, 0.15. For maximum ratings, characteristics, and curves, refer to type 12AT7.

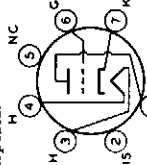

6AB4

6AB5/ 6N5

ELECTRON-RAY TUBE
Glass type with triode unit used to indicate visually by means of a fluorescent target the effects of a change in a controlling voltage. It is used as a convenient means of indicating accurate radio-receiver tuning. Maximum dimensions: over-all length, 4-3/16 inches; seated height, 3-9/16 inches; diameter, 1-3/16 inches. Tube requires six-contact socket. Heater volts (ac/dc), 6.3; amperes, 0.15. Maximum ratings (ac/dc), 6.3; amperes, 0.15. Maximum ratings in indicator service: triode-plate supply volts, 180 *maz*; fluorescent-target volts, 125 *min.* This type is used principally for renewal purposes.

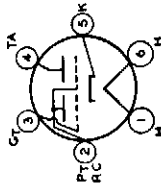

6AB7

SHARP-CUTOFF PENTODE

Metal type used in rf and if stages of picture amplifier of television receivers particularly those employing automatic-gain control. Outline 2, OUTLINES SECTION. Tube requires octal socket. Heater volts (ac/dc), 6.3; amperes, 0.45. Maximum ratings as class A1 amplifier: plate and grid-No.2 supply volts, 300 *maz*; grid No.3, connect to cathode at socket; grid-No.2, 200 *maz*; plate dissipation, 4.75 *maz watts*; grid No.2 input, 0.55 *maz watt*. Typical operation: plate and grid-No.2 supply volts, 300; grid-No.3 volts, 0; grid-No.2 series resistor, 30000 ohms; grid-No.1 volts, -3; plate resistance (approx.), 0.7 megohm; transconductance, 5000 amhos; grid-No.1 volts for transconductance of 50 amhos, -22.5; plate ma., 12.5; grid-No.2 ma., 3.2. This type is used principally for renewal purposes.

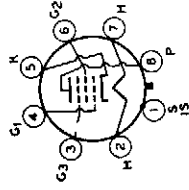

6AC5GT

HIGH-MU POWER TRIODE

Glass octal type used in single-ended or push-pull audio-frequency power amplifiers of the direct-coupled type in which a driver tube develops positive grid bias for the 6AC5-GT output stage. Outline 14C, OUTLINES SECTION. This type may be supplied with pin No. 1 omitted. Tube requires octal socket. Heater 1 omitted. Maximum ratings as push-pull class B power amplifier: plate volts, 250 *maz*; peak plate ma., 110 *maz*; average plate dissipation, 10 *maz watts*. This type is used principally for renewal purposes.

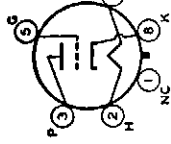

6AC7

SHARP-CUTOFF PENTODE

Metal type used as video amplifier tube in television receivers, and as a mixer or oscillator tube in low-frequency applications. Outline 2, OUTLINES SECTION. Tube requires octal socket. Heater volts (ac/dc), 6.3; amperes, 0.45. Characteristics as class A1 amplifier: plate and grid-No.2 supply volts, 300 *maz*; grid No.3 connect to cathode at socket; grid-No.2 series resistor, 60000 ohms; cathode-bias resistor, 160 ohms; plate resistance (approx.), 1 megohm; transconductance, 9000 amhos; plate ma., 10; grid-No.2 ma., 2.5; plate dissipation, 3 *maz watts*; peak heater-cathode volts, 90 *maz*. This type is used principally for renewal purposes.

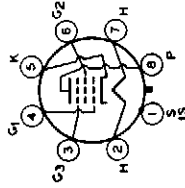

ELECTRON-RAY TUBE

Glass octal type used to indicate visually, by means of two shadows on the fluorescent target, the effects of changes in the controlling voltages. It is a twin-indicator type and is used as a convenient means of indicating accurate radio-receiver tuning. Maximum over-all length, 2-7/8 inches; maximum diameter, 1-5/16 inches. Heater volts (ac/dc), 6.3; amperes, 0.15. Maximum target volts, 150. This is a DISCONTINUED type listed for reference only.

6AD6G

LOW-MU TRIODE — POWER PENTODE

Glass octal type used in a push-pull amplifier circuit in conjunction with type 6F6-G. Triode unit serves as phase inverter. Outline 26, OUTLINES SECTION. Tube requires octal socket. Heater volts (ac/dc), 6.3; amperes, 0.85. For typical operation of pentode unit, refer to type 6F6-G. Maximum ratings of pentode unit as class A1 or push-pull class AB1 amplifier: plate volts, 375 *maz*; grid-No. 2 volts, 285 *maz*; plate dissipation, 8.5 *maz watts*; grid-No.2 input, 2.7 *maz watts*. Maximum ratings of triode unit as class A1 amplifier: plate volts, 285 *maz*; plate dissipation, 1.0 *maz watt*. This type is used principally for renewal purposes.

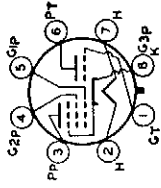

6AD7G

LOW-MU TRIODE

Glass octal type used as class A1 amplifier in ac/dc radio receivers. Outline 14C, OUTLINES SECTION. Heater volts (ac/dc), 6.3; amperes, 0.3. Maximum ratings as class A1 amplifier: plate volts, 300 *maz*; plate dissipation, 2.5 *maz watts*. This is a DISCONTINUED type listed for reference only.

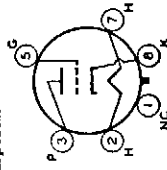

6AE5GT

TWIN-PLATE CONTROL TUBE

Glass octal type used as a control tube for twin-indicator type electron-ray tubes. Outline 22, OUTLINES SECTION. Contains two triodes with different cutoff characteristics. If a voltage is applied to the common control grid in suitable circuit, one triode section operates on weak signals while the other operates on strong signals. Heater voltage (ac/dc), 6.3; amperes, 0.15. This is a DISCONTINUED type listed for reference only.

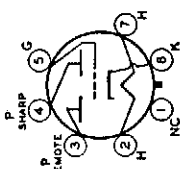

6AE6G

TWIN-INPUT TRIODE

Glass octal type used as a voltage amplifier or as a driver for two type 6AC5-GT tubes in dynamic-coupled, push-pull amplifiers. In the latter service, type 6AE7-GT replaces two tubes ordinarily required as drivers. Outline 14C, OUTLINES SECTION. Heater volts (ac/dc), 6.3; amperes, 0.5. This is a DISCONTINUED type listed for reference only.

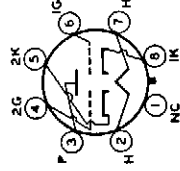

6AE7GT

HALF-WAVE VACUUM RECTIFIER

Miniature type used as a damper tube in horizontal deflection circuits of television receivers. Outline 9B, OUTLINES SECTION. Tube requires miniature nine-contact socket and may be mounted in any position. Socket terminals 1, 2, 3, 6, 7, and 8 should not be used as tie points. It is especially important that this tube, like other power-handling tubes, be adequately ventilated. Heater volts (ac/dc), 6.3; amperes, 1.2.

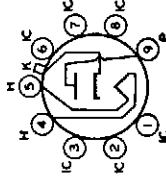

6AF3

Related type:
12AF3

DAMPER SERVICE

For operation in a 525-line, 30-frame system

Maximum Ratings, (Design-Maximum Values):	
PEAK INVERSE PLATE VOLTAGE*	4500 <i>maz volts</i>
PEAK PLATE CURRENT	750 <i>maz ma</i>
AVERAGE PLATE CURRENT	185 <i>maz ma</i>
PEAK HEATER CATHODE VOLTAGE:	
Heater negative with respect to cathode	4500* <i>maz volts</i>
Heater positive with respect to cathode	300* <i>maz volts</i>
BULB TEMPERATURE (At hottest point)	210 <i>maz °C</i>

* The duration of the voltage pulse must not exceed 15 per cent of one horizontal scanning cycle. In a 525-line, 30-frame system, 15 per cent of one horizontal scanning cycle is 10 microseconds.
* The dc component must not exceed 1000 volts.
* The dc component must not exceed 100 volts.

6AF4

6AF4A

Related types:
2AF4B, 3AF4A

MEDIUM-MU TRIODE

Miniature types used as local oscillators in uhf television receivers covering the frequency range of 470 to 890 megacycles per second. 6AF4 Outline 7B, 6AF4-A Outline 7A, OUTLINES SECTION. Tubes requires miniature seven-contact socket and may be mounted in any position.

HEATER VOLTAGE (AC/DC).....	6.3 volts
HEATER CURRENT.....	0.225 ampere
DIRECT INTERELECTRODE CAPACITANCES:*	
Grid to Plate.....	1.9 pf
Grid to Cathode and Heater.....	2.2 pf
Plate to Cathode and Heater.....	1.4 pf
Heater to Cathode**.....	2.2 pf

** With external shield connected to cathode, except as noted.
** With external shield connected to plate.

CLASS A₁ AMPLIFIER

Characteristics:	
Plate Supply Voltage.....	80 volts
Cathode-Bias Resistor.....	150 ohms
Amplification Factor.....	18.5
Plate Resistance (Approx.).....	2100 ohms
Transconductance.....	6500 μ mhos
Plate Current.....	17.5 ma

UHF OSCILLATOR

Maximum Ratings, (Design-Maximum Values):	
PLATE VOLTAGE.....	150 maz
GRID VOLTAGE, Negative-bias value.....	-50 maz
GRID CURRENT.....	2 maz
DC CATHODE CURRENT.....	24 maz
PEAK HEATER-CATHODE VOLTAGE: Heater positive with respect to cathode.....	50 maz
Heater negative with respect to cathode.....	50 ⁰ -maz

Typical Operation as Oscillator at 1000 Mc:

Plate Supply Voltage.....	100 volts
Plate Resistor.....	220 ohms
Grid Resistor.....	10000 ohms
Plate Current.....	17 ma
Grid Current (Approx.).....	750 μ a

Maximum Circuit Values:

Grid-Circuit Resistances: For fixed-bias operation.....	Not recommended
For cathode-bias operation.....	0.5 maz
The dc component must not exceed 25 volts.	megohm

AVERAGE PLATE CHARACTERISTICS

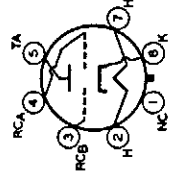
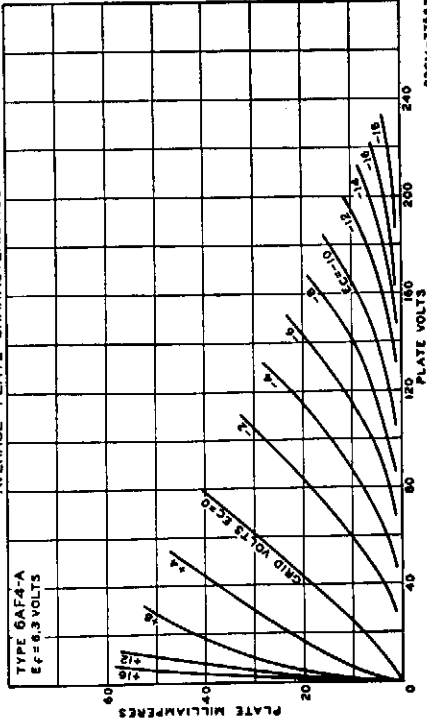

ELECTRON-RAY TUBE

Glass octal used to indicate visually, by means of two shadows on the fluorescent target, the effects of changes in the controlling voltages. It is a twin-indicator type and is used as a convenient means of indicating accurate radio-receiver tuning. Maximum over-all length, 2-5/16 inches; maximum diameter, 1-5/16 inches.

This type may be supplied with pin No. 1 omitted. Tube requires octal socket. Heater volts (ac/dc), 6.3; amperes, 0.15. Maximum ratings in indicator service; fluorescent-target volts, 250 maz, 125 maz; ray-control-electrode supply volts, 250 maz; peak heater-cathode volts, 90 maz. Typical operation: fluorescent-target volts, 250; fluorescent-target ma., 3.75; ray-contact-electrode volts (approx. for 0° shadow angle), 155; ray-control-electrode volts (approx. for 100° shadow angle), 0.

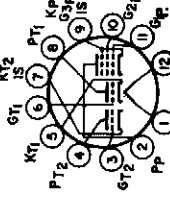

DUAL TRIODE— SHARP-CUTOFF PENTODE

Duodecar type used in a variety of applications in television receivers. The high-mu triode unit is used for agc keyer service, the medium-mu triode unit for sync separator service, and the pentode unit for video amplifier service. Outline 12C, OUTLINES SECTION. Tube requires duodecar twelve-contact socket and may be mounted in any position. Heater volts (ac/dc), 6.3; amperes, 1.05.

6AF11

Related type:
15AF11

CLASS A₁ AMPLIFIER

Maximum Ratings, (Design-Maximum Values):

PLATE VOLTAGE.....	Triode Unit No. 1 380 maz	Triode Unit No. 2 380 maz	Periodic Unit 380 maz
GRID-NO. 2 (SCREEN-GRID SUPPLY) VOLTAGE.....	0 maz	0 maz	0 maz
GRID-NO. 2 VOLTAGE.....	1.1 maz	2 maz	5 maz
GRID-NO. 1 (CONTROL-GRID) VOLTAGE, Positive-bias value.....	—	—	1.25 maz
PLATE DISSIPATION.....	—	—	See curve page 70
GRID-NO. 2 INPUT: For grid-No.2 voltages up to 165 volts.....	200 maz	200 maz	200 maz
For grid-No.2 voltages between 165 and 380 volts.....	200 ⁰ -maz	200 ⁰ -maz	200 ⁰ -maz
PEAK HEATER-CATHODE VOLTAGE: Heater negative with respect to cathode.....	—	—	—
Heater positive with respect to cathode.....	—	—	—

Characteristics

Plate Supply Voltage.....	200	200	250
Grid-No.2 Supply Voltage.....	—	—	150
Grid-No.1 Voltage.....	-2	—	100
Cathode-Bias Resistor.....	68	41	—
Amplification Factor.....	12400	9400	68000
Plate Resistance (Approx.).....	5500	4400	11000
Transconductance.....	7	9.2	24
Plate Current.....	—	—	4.8
Grid-No.2 Current.....	—	—	—
Grid-No.1 Voltage (Approx.) for plate current of 100 μ a.....	—	-6.5	-10

Maximum Circuit Values:

Grid-No.1-Current Resistance: For fixed-bias operation.....	0.5 maz	0.5 maz	0.25 maz
For cathode-bias operation.....	1 maz	1 maz	1 maz
The dc component must not exceed 100 volts.			megohm

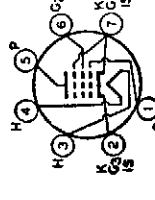

SHARP-CUTOFF PENTODE

Miniature type used in compact radio equipment as an rf or if amplifier up to 400 megacycles per second. Outline 7B, OUTLINES SECTION. Tube requires miniature seven-contact socket and may be mounted in any position. Except for slightly different

6AG5

Except for slightly different

characteristics, this type is similar electrically to miniature type 6BC5. Heater volts (ac/dc), 6.3; amperes, 0.3. For typical operation as a resistance-coupled amplifier, refer to RESISTANCE-COUPLED AMPLIFIER SECTION.

POWER PENTODE

Metal type used in output stage of video amplifier of television receivers. Outline 5, OUTLINES SECTION. Tube requires octal socket. Heater

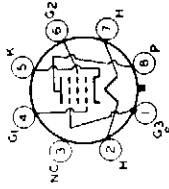

volts (ac/dc), 6.3; amperes, 0.65. Typical operation as class A₁ amplifier: plate volts, 300 *max*; grid No.3 connected to cathode at socket; grid-No.2 volts, 150 (300 *max*); grid-No.1 volts, -3 (0 *max*); peak at grid-No.1 volts, 3; plate ma., 30 (zero signal), 30.5 (maximum signal); grid-No.2 ma., 7 (zero signal); 9 (maximum signal); plate resistance (approx.), 0.13 megohm; transconductance, 11000 μ mhos; load resistance, 10000 ohms; maximum-signal power output, 3 watts; plate dissipation, 9 *max* watts; grid-No.2 input, 1.5 *max* watts.

6AG7

LOW-MU TRIODE

Glass octal type having high pervence used as vertical deflection amplifier in television receivers. Outline 14C, OUTLINES SECTION. Tube requires octal socket and may be mounted in any position. Heater volts (ac/dc), 6.3; amperes, 0.75. Characteristics as class A₁ amplifier: plate volts, 250; grid volts, -23; amplification factor, 8; plate resistance (approx.), 1780 ohms; transconductance, 4500 μ mhos; plate ma., 30.

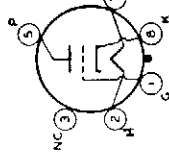

Maximum ratings as vertical-deflection amplifier (for operation in 525-line, 30-frame system): dc plate volts, 500 *max*; peak positive-pulse plate volts, 2000 *max*; peak negative-pulse grid volts, -200 *max*; peak cathode ma., 180 *max*; average cathode ma., 60 *max*; plate dissipation, 7.5 *max* watts; peak heater-cathode volts, 200 *max* (the dc component must not exceed 100 volts). This type is used principally for renewal purposes.

6AH4GT

SHARP-CUTOFF PENTODE

Miniature type used as an rf or amplifier in video stages of television receivers. Outline 7B, OUTLINES SECTION. Tube requires miniature seven-contact socket. Heater volts (ac/dc), 6.3; amperes, 0.45. Characteristics as class A₁ amplifier: plate supply volts, 300 *max*; grid No.3 connected to cathode at socket; grid-No.2 supply volts, 150 (300 *max*); cathode-bias resistor, 160 ohms; plate resistance (approx.), 0.5 megohm; transconductance, 9000 μ mhos; plate ma., 10; grid-No.2 ma., 2.5; plate dissipation, 3.2 *max* watts; peak heater-cathode volts, 90 *max*. This type is used principally for renewal purposes.

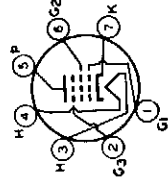

6AH6

SHARP-CUTOFF PENTODE

Miniature type used as an rf or amplifier especially in high-frequency wide-band applications. It is useful as an amplifier at frequencies up to 400 megacycles per second. Outline 7A, OUTLINES SECTION. Tube requires miniature seven-contact socket and may be mounted in any position.

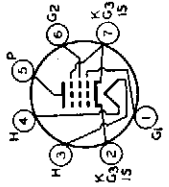

6AK5

HEATER VOLTAGE (AC/DC)	6.3	volts
HEATER CURRENT	0.175	ampere
DIRECT INTERELECTRODE CAPACITANCES (Approx.):*		
Grid No.1 to Plate	0.02	max pf
Grid No.1 to Cathode, Heater, Grid No.2, Grid No.3, and Internal Shield	4.0	pf
Plate to Cathode, Heater, Grid No.2, Grid No.3, and Internal Shield	2.8	pf

CLASS A₁ AMPLIFIER

Maximum Ratings, (Design-Center Values):

PLATE VOLTAGE	180 <i>max</i>	volts
GRID-No.2 (SCREEN-GRID) VOLTAGE	See curve page 70	volts
GRID-No.2 SUPPLY VOLTAGE	180 <i>max</i>	volts
GRID-No.1 VOLTAGE, Positive-bias value	0 <i>max</i>	volts
PLATE DISSIPATION	1.7 <i>max</i>	watts
GRID-No.2 INPUT		
For grid-No.2 voltages up to 90 volts	0.5 <i>max</i>	watt
For grid-No.2 voltages between 90 and 180 volts	See curve page 70	ma
CATHODE CURRENT	18 <i>max</i>	ma
PEAK HEATER-CATHODE VOLTAGE	90 <i>max</i>	volts
Heater negative with respect to cathode	90 <i>max</i>	volts

Characteristics:

Plate Supply Voltage	120	volts
Grid-No.2 Supply Voltage	120	volts
Cathode-Bias Resistor	180	ohms
Plate Resistance (Approx.)	0.3	megohm
Transconductance	5600	μ mhos
Grid-No.1 Voltage for plate current of 10 μ a	-8.5	volts
Plate Current	7.7	ma
Grid-No.2 Current	2.5	ma

* With external shield connected to pins 2 or 7.

HALF-WAVE VACUUM RECTIFIER

Miniature type used as damper tube in horizontal-deflection circuits of television receivers. Outline 9C, OUTLINES SECTION. Tube requires miniature nine-contact socket and may

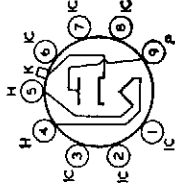

be mounted in any position. Socket terminals 1, 2, 3, 6, 7, and 8 should not be used as the points. It is especially important that this tube, like other power-handling tubes, be adequately ventilated. Heater volts (ac/dc), 6.3; amperes, 1.55.

6AL3

DAMPER SERVICE

For operation in 525-line, 30-frame system

Maximum Ratings, (Design-Center Values):		
PEAK INVERSE PLATE VOLTAGE* (Absolute maximum)	7500*	max volts
PEAK PLATE CURRENT	550	max ma
DC PLATE CURRENT	220	max ma
PLATE DISSIPATION	5	max watts
PEAK HEATER-CATHODE VOLTAGE	6600	max volts

* Under no circumstances should this absolute value be exceeded.

The duration of the voltage pulse must not exceed 15 per cent of one horizontal scanning cycle. In a 525-line, 30-frame system, 15 per cent of one horizontal scanning cycle is 10 microseconds.

TWIN DIODE

Miniature, high-pervence type used as detector in FM and television circuits. It is especially useful as a ratio detector in ac-operated FM receivers. Each diode section can be used independently of the other, or the two sections can be combined in parallel or full-wave arrangement. Resonant frequency of each unit is approximately 700 megacycles per second. Outline 7A, OUTLINES SECTION. Tube requires miniature seven-contact socket and may be mounted in any position.

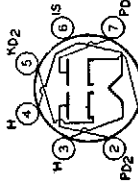

6AL5

Related types: 3AL5, 12AL5

HEATER VOLTAGE (AC/DC)	6.3	volts
HEATER CURRENT	0.3	ampere
DIRECT INTERELECTRODE CAPACITANCES:		
Plate No.1 to Cathode No.1, Heater, and Internal Shield	2.5	pf
Plate No.2 to Cathode No.2, Heater, and Internal Shield	3.4	pf
Cathode No.1 to Plate No.1, Heater, and Internal Shield	3.4	pf
Cathode No.2 to Plate No.2, Heater, and Internal Shield	0.068	max pf
Plate No.1 to Plate No.2		

HALF-WAVE RECTIFIER

Maximum Ratings, (Design-Center Values):

PEAK INVERSE PLATE VOLTAGE.....	330 max	volts
PEAK PLATE CURRENT (Per Plate).....	64 max	ma
DC OUTPUT CURRENT (Per Plate).....	9 max	ma
PEAK HEATER-CATHODE VOLTAGE.....	330 max	volts
Heater negative with respect to cathode.....	330 max	volts
Heater positive with respect to cathode.....		
Typical Operation:		
AC Plate Voltage per Plate (rms).....	117	volts
Min. Total Effective Plate-Supply Impedance per Plate.....	300	ohms
DC Output Current per Plate.....	9	ma

AVERAGE CHARACTERISTICS

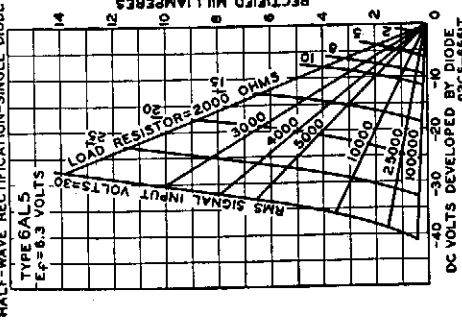

ELECTRON-RAY TUBE

Glass oval type used to indicate visually on a pair of rectangular fluorescent patterns the effects of changes in voltages applied to its grid and three deflecting electrodes. It is especially useful in meeting the requirements for accurate tuning in FM receivers. Maximum dimensions: over-all length, 3-1/16 inches; seated height, 2-1/2 inches; diameter, 1-9/32 inches. Tube requires octal socket and may be mounted in any position. Heater volts (ac/dc), 6.3; amperes, 0.15. Maximum ratings in indicator service: target volts, 365 max; 230 min; peak heater-cathode volts, 90 max; typical operation in indicator service: fluorescent-target volts, 315; deflecting electrodes Nos. 1, 2, and 3 volts, 0; cathode resistor (approx.), 3300 ohms; deflection sensitivity (approx.), 1 mm/volt; grid volts for fluorescence cutoff, -7. This type is used principally for renewal purposes.

6AL7GT

BEAM POWER TUBE—SHARP-CUTOFF PENTODE

Duodec type used as FM detector and audio-frequency output amplifier in television receivers. Outline 12B, OUTLINES SECTION. Tube requires duodec twelve-contact socket and may be mounted in any position. Heater volts (ac/dc), 6.3; amperes, 0.9.

6AL11

Related type: 12AL11

BEAM POWER UNIT AS CLASS A₁ AMPLIFIER

Maximum Ratings, (Design-Maximum Values):

PLATE VOLTAGE.....	275 max	volts
GRID-NO.2 (SCREEN-GRID) VOLTAGE.....	275 max	volts
PLATE DISSIPATION.....	10 max	watts
GRID-NO.2 INPUT.....	2 max	watts

PEAK HEATER-CATHODE VOLTAGE:

Heater negative with respect to cathode.....

Heater positive with respect to cathode.....

Typical Operation:

Plate Voltage.....	200 max	volts
Grid-No.2 Voltage.....	200 max	volts
Grid-No.1 (Control-Grid) Voltage.....	250	volts
Peak AF Grid-No.1 Voltage.....	-8	volts
Zero-Signal Plate Current.....	8	ma
Maximum-Signal Plate Current.....	35	ma
Zero-Signal Grid-No.2 Current.....	39	ma
Maximum-Signal Grid-No.2 Current.....	2.5	ma
Plate Resistance (Approx.).....	7	ma
Transconductance.....	0.1	megohm
Load Resistance.....	6500	ohms
Total Harmonic Distortion.....	5000	ohms
Maximum-Signal Power Output.....	10	per cent
	4.2	watts

Maximum Circuit Values:

Grid-No.1-Circuit Resistance:

For fixed-bias operation.....

For cathode-bias operation.....

■ The dc component must not exceed 100 volts.

PENTODE UNIT AS CLASS A₁ AMPLIFIER

Characteristics:

Plate Supply Voltage.....	150	volts
Grid-No.3 (Suppressor-Grid) Voltage.....	0	volts
Grid-No.2 (Screen-Grid) Supply Voltage.....	100	volts
Cathode-Bias Resistor.....	560	ohms
Plate Resistance (Approx.).....	0.15	megohm
Transconductance, Grid No.1 to Plate.....	1000	amhos
Transconductance, Grid No.3 to Plate.....	400	amhos
Plate Current.....	1.3	ma
Grid-No.2 Current.....	2.1	ma
Grid-No.1 Voltage (Approx.) for plate current of 30 μ a.....	-4.5	volts
Grid-No.3 Voltage (Approx.) for plate current of 50 μ a.....	-4.5	volts

PENTODE UNIT AS FM DETECTOR

Maximum Ratings, (Design-Maximum Values):

PLATE VOLTAGE.....	330 max	volts
GRID-NO.3 VOLTAGE.....	28 max	volts
GRID-NO.2 SUPPLY VOLTAGE.....	330 max	volts
GRID-NO.2 VOLTAGE.....	See curve page 70	
GRID-NO.1 (CONTROL-GRID) VOLTAGE, Positive-bias value.....	0 max	volts
PLATE DISSIPATION.....	1.7 max	watts
GRID-NO.2 INPUT:		
For grid-No.2 voltages up to 165 volts.....	1.1 max	watts
For grid-No.2 voltages between 165 and 330 volts.....	See curve page 70	
PEAK HEATER-CATHODE VOLTAGE:		
Heater negative with respect to cathode.....	200 max	volts
Heater positive with respect to cathode.....	200 max	volts
■ The dc component must not exceed 100 volts.		

HIGH-MU TRIODE

Miniature type used as mixer and rf amplifier in cathode-drive circuits of uhf television receivers. Outline 8A, OUTLINES SECTION. Tube requires miniature nine-contact socket and may be mounted in any position. Heater volts (ac/dc), 6.3; amperes, 0.225. Characteristics as class A₁ amplifier: plate-supply volts, 200 max; cathode-bias resistor, 100 ohms; amplification factor, 85; plate resistance (approx.), 8700 ohms; transconductance, 3800 amhos; plate ma., 10; plate dissipation, 2 max watts; peak heater-cathode volts, 80 max. This type is used principally for renewal purposes.

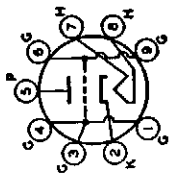

6AM4

DIODE—SHARP-CUTOFF PENTODE

6AM8
6AM8A

Related type:
5AM8

Miniature types used in diversified applications in television receivers. Type 6AM8-A has a controlled heater warm-up time for use in receivers employing series-connected heater strings.

The pentode unit is used as an if amplifier, video amplifier, or agc amplifier. The high-perveance diode is used as an audio detector, video detector, or dc restorer. Outline 8B, OUTLINES SECTION. Tubes require miniature nine-contact socket and may be mounted in any position. Type 6AM8 is a DISCONTINUED type listed for reference only.

HEATER VOLTAGE (AC/DC).....	6.3	volts
HEATER CURRENT.....	0.45	ampere
HEATER WARM-UP TIME (AVERAGE) FOR 6AM8-A.....	11	seconds
DIRECT INTERELECTRODE CAPACITANCES:		
Diode Unit:		
Plate to Cathode and Heater.....	1.8	pf
Cathode to Plate and Heater.....	3	pf
Pentode Unit:		
Grid No.1 to Plate.....	0.015	max
Grid No.1 to Cathode, Heater, Grid No.2, No.3 and Internal Shield.....	6.5	pf
Plate to Cathode, Heater, Grid No.2, No.3, and Internal Shield.....	2.6	pf
Pentode Grid No.1 to Diode Plate.....	0.006	max
Pentode Plate to Diode Cathode.....	0.15	max
Pentode Plate to Diode Plate.....	0.1	max

PENTODE UNIT AS CLASS A₁ AMPLIFIER

Maximum Ratings, (Design-Maximum Values):

PLATE VOLTAGE.....	330	max	volts
GRID-NO.3 (SUPPRESSOR-GRID) VOLTAGE, Positive value.....	0	max	volts
GRID-NO.2 (SCREEN-GRID) SUPPLY VOLTAGE.....	330	max	volts
GRID-NO.2 VOLTAGE.....	See curve page 70		
GRID-NO.1 (CONTROL-GRID) VOLTAGE, Positive-bias value.....	0	max	volts
PLATE DISSIPATION.....	3.2	max	watts
GRID-NO.2 INPUT.....	0.55	max	watt
For grid-No.2 voltages up to 165 volts.....	See curve page 70		
For grid-No.2 voltages between 165 and 330 volts.....			
PEAK HEATER-CATHODE VOLTAGE:			
Heater negative with respect to cathode.....	200	max	volts
Heater positive with respect to cathode.....	200 ^μ	max	volts

Characteristics

Plate Supply Voltage.....	125	volts
Grid No.3.....	Connected to cathode at socket	
Grid-No.2 Supply Voltage.....	125	volts

AVERAGE CHARACTERISTICS

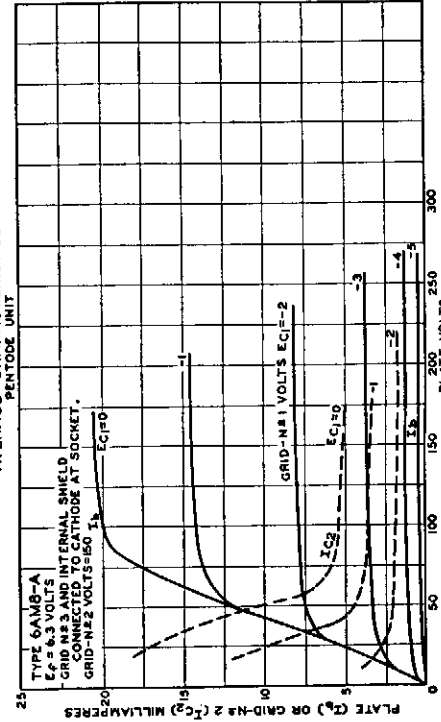

Cathode-Bias Resistor.....	56	ohms
Plate Resistance (Approx.).....	0.3	megohm
Transconductance.....	7800	μmhos
Grid-No.1 Voltage (Approx.) for plate current of 20 μa.....	-6	volts
Grid-No.1 Voltage (Approx.) for plate current of 2 ma and cathode-bias resistor of 0 ohms.....	-3	volts
Plate Current.....	12.5	ma
Grid-No.2 Current.....	3.2	ma

Maximum Circuit Values:

Grid-No.1-Circuit Resistance: For fixed-bias operation.....	0.25	max	megohm
For cathode-bias operation.....	1.0	max	megohm

DIODE UNIT

Maximum Ratings, (Design-Maximum Values):

DC PLATE CURRENT.....	5	max	ma
PEAK HEATER-CATHODE VOLTAGE:			
Heater negative with respect to cathode.....	200	max	volts
Heater positive with respect to cathode.....	200 ^μ	max	volts

*The dc component must not exceed 100 volts.

HIGH-MU TRIODE

Miniature type used as mixer or if amplifier in cathode-drive circuits of uhf television tuners covering the frequency range of 470 to 890 megacycles per second. Outline 7A, OUTLINES SECTION. Tube requires miniature seven-contact socket and may be mounted in any position. Heater volts (ac/dc), 6.3; amperes, 0.225.

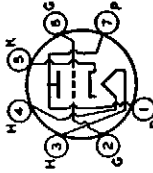

CLASS A₁ AMPLIFIER

Maximum Ratings, (Design-Center Values):

PLATE VOLTAGE.....	300	max	volts
PLATE DISSIPATION.....	4	max	watts
CATHODE CURRENT.....	80	max	ma
PEAK HEATER-CATHODE VOLTAGE:			
Heater negative with respect to cathode.....	200	max	volts
Heater positive with respect to cathode.....	200 ^μ	max	volts

Characteristics

Plate-Supply Voltage.....	200	volts
Cathode-Bias Resistor.....	100	ohms
Amplification Factor.....	70	
Transconductance.....	10000	μmhos
Plate Current.....	13	ma
Grid Voltage (Approx.) for plate current of 20 μa.....	-7	volts

Maximum Circuit Values:

Grid-Circuit Resistance: For fixed-bias operation.....	0.1	max	megohm
For cathode-bias operation.....	0.5	max	megohm

*The dc component must not exceed 100 volts.

MEDIUM-MU TRIODE—SHARP-CUTOFF PENTODE

Miniature types used in a wide variety of applications in color television receivers. The 6AN8-A has a controlled heater warm-up time for use in receivers employing series-connected heater strings. The pentode unit is used as an intermediate-frequency amplifier, a video amplifier, an agc amplifier, or as a reactance tube. The triode unit is used in low-frequency oscillator, sync-separator, sync-clipper, and phase-splitter circuits. Outline 8B, OUTLINES SECTION. Tubes require miniature nine-contact socket and may be mounted in any position. Type 6AN8 is a DISCONTINUED type listed for reference only.

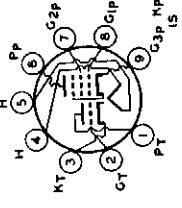

6AN8
6AN8A

Related type:
5AN8

Maximum Ratings, (Design-Maximum Values):

HEATER VOLTAGE (AC/DC).....	6.3	volts
HEATER CURRENT.....	0.45	ampere
HEATER WARM-UP TIME (AVERAGE) 6AN8-A.....	11	seconds

DIRECT INTERELECTRODE CAPACITANCES:

Triode Unit:			
Grid to Plate.....	1.5		pf
Grid to Cathode and Heater.....	2.0		pf
Plate to Cathode and Heater.....	0.26		pf
Pentode Unit:			
Grid No.1 to Plate.....	0.04	0.04	maz
Grid No.1 to Cathode, Heater, Grid No.2, Grid No.3, and Internal Shield.....	7		pf
Plate to Cathode, Heater, Grid No.2, Grid No.3, and Internal Shield.....	2.4		pf
Triode Grid to Pentode Plate.....	0.02		pf
Pentode Grid No.1 to Triode Plate.....	0.02		pf
Pentode Plate to Triode Plate.....	0.15		pf

CLASS A₁ AMPLIFIER

Maximum Ratings, (Design-Maximum Values):	Triode Unit	Pentode Unit
PLATE VOLTAGE.....	330 maz	330 maz
GRID-NO.2 SUPPLY VOLTAGE.....	330 maz	330 maz
GRID-NO.2 (SCREEN-GRID) VOLTAGE.....	See curve page 70	See curve page 70
GRID-NO.1 (CONTROL-GRID) VOLTAGE, Positive-bias value.....	0 maz	0 maz
PLATE DISSIPATION.....	2.8 maz	2.3 maz
GRID-NO.2 INPUT:		
For grid-No.2 voltages up to 165 volts.....	0.55 maz	0.55 maz
For grid-No.2 voltages between 165 and 330 volts.....	See curve page 70	See curve page 70
PEAK HEATER-CATHODE VOLTAGE:	200 maz	200 ^b maz
Heater negative with respect to cathode.....		
Heater positive with respect to cathode.....		

Characteristics:

Plate Supply Voltage.....	Triode Unit	Pentode Unit
Grid-No.2 Supply Voltage.....	150	125
Grid-No.1 Voltage.....	-3	125
Cathode-Bias Resistor.....	56	56
Amplification Factor.....	21	170000
Plate Resistance (Approx.).....	4700	7800
Transconductance.....	4500	7800
Grid-No.1 Voltage (Approx.) for plate current of 20 _{ma} and cathode-bias resistor of 0 ohms.....	-17	-6
Plate Current.....	15	3
Grid-No.2 Current.....	1	12
		3.8

Maximum Circuit Values:

Grid-No.1-Circuit Resistance: ^a	0.5 maz
For fixed-bias operation.....	1.0 maz
For cathode-bias operation.....	
^a The dc component must not exceed 100 volts.	
^b If either unit is operating at maximum rated conditions, grid-No.1-circuit resistance for both units should not exceed the stated values.	

BEAM POWER TUBE

6AQ5
6AQ5A
Related types:
5AQ5, 12AQ5

Miniature types used as output amplifiers primarily in automobile receivers and in ac-operated receivers and triode-connected, as vertical deflection amplifiers in television receivers. Type 6AQ5-A has a controlled heater warm-up time for use in television receivers employing series-connected heater strings. Outline 7C, OUTLINES SECTION. Tubes require miniature seven-contact socket and may be mounted in any position. Within their maximum ratings, the performance of these types is equivalent to that of larger types 6V6 and 6V6-GTA. Type 6AQ5 is a DISCONTINUED type listed for reference only.

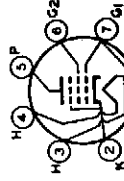

HEATER VOLTAGE (AC/DC).....	6.3	volts *
HEATER CURRENT.....	0.45	ampere
HEATER WARM-UP TIME (Average) for 6AQ5-A.....	11	seconds
DIRECT INTERELECTRODE CAPACITANCES (Approx.):		
Grid No.1 to Plate.....	0.4	pf
Grid No.1 to Cathode, Heater, Grid No.2, and Grid No.3.....	8	pf
Plate to Cathode, Heater, Grid No.2, and Grid No.3.....	8.5	pf
AMPLIFICATION FACTOR ^a	9.5	pf
PLATE RESISTANCE (Approx.) ^b	1970	ohms
TRANSCONDUCTANCE ^b	4800	μmhos
GRID-NO.1 VOLTAGE (Approx.) for plate current of 0.5 ma.....	-37	volts
^a Grid No.2 connected to plate; plate and grid-No.2 volts, 250; grid-No.1 volts, -12.5; plate ma., 49.5.		

AVERAGE CHARACTERISTICS

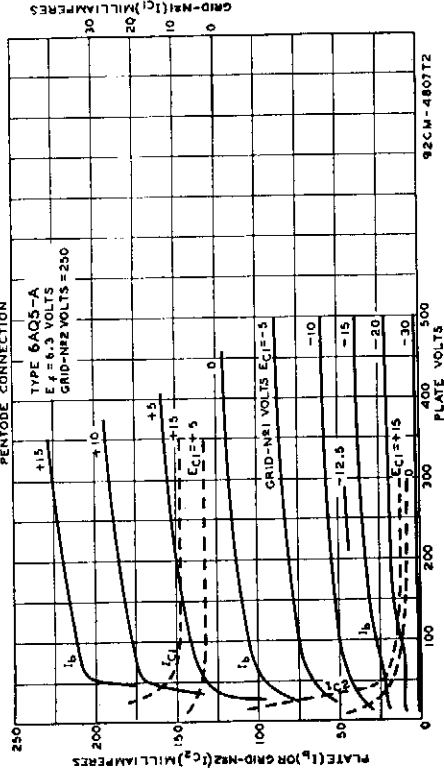

CLASS A₁ AMPLIFIER

Maximum Ratings, (Design-Maximum Values):

PLATE VOLTAGE.....	275 maz	volts
GRID-NO.2 (SCREEN-GRID) VOLTAGE.....	275 maz	volts
PLATE DISSIPATION.....	1.2 maz	watts
GRID-NO.2 INPUT.....	2 maz	watts
PEAK HEATER-CATHODE VOLTAGE:		
Heater negative with respect to cathode.....	200 maz	volts
Heater positive with respect to cathode.....	200 ^b maz	volts
BULB TEMPERATURE (At hottest point).....	250 maz	°C

^b The dc component must not exceed 100 volts.

Typical Operation:

Same as for type 6V6-GTA within the limitations of the maximum ratings.

Maximum Circuit Values:

Grid-No.1-Circuit Resistance:	0.1 maz
For fixed-bias operation.....	0.5 maz
For cathode-bias operation.....	
	megohm

AVERAGE CHARACTERISTICS

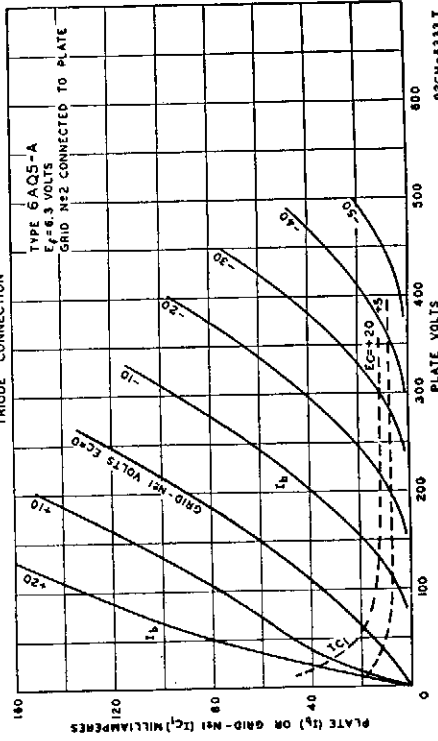

VERTICAL DEFLECTION AMPLIFIER (Triode Connection)¹

For operation in a 525-line, 30-frame system

Maximum Ratings, (Design-Maximum Values):

DC PLATE VOLTAGE.....	275 max	volts
PEAK POSITIVE-PULSE PLATE VOLTAGE.....	1100 max	volts
PEAK NEGATIVE-PULSE GRID-NO.1 (CONTROL-GRID) VOLTAGE.....	-275 max	volts
PEAK CATHODE CURRENT.....	115 max	ma
AVERAGE CATHODE CURRENT.....	40 max	ma
PLATE DISSIPATION.....	10 max	watts
PEAK HEATER-CATHODE VOLTAGE.....	200 max	volts
Heater negative with respect to cathode.....	200*max	volts
Heater positive with respect to cathode.....	250 max	volts
BULB TEMPERATURE (At hottest point).....		°C

Maximum Circuit Value:

Grid-No.1-Circuit Resistance: For cathode-bias operation.....	2.2 max	megohms
Grid No.2 connected to plate.....		
† The duration of the voltage pulse must not exceed 15 per cent of one vertical scanning cycle. In a 525-line, 30-frame system, 15 per cent of one vertical scanning cycle is 2.5 milliseconds.		
‡ The dc component must not exceed 100 volts.		

6AQ6

TWIN DIODE—HIGH-MU TRIODE

Miniature type used as combined detector, amplifier, and avc tube in compact radio receivers. Outline 7B, OUTLINES SECTION. Tube requires miniature seven-contact socket. Heater volts (ac/dc), 6.3; amperes, 0.15. Characteristics of triode unit as class A₁ amplifier: plate volts, 250 (300 max); grid volts, -3; amplification factor, 70; plate resistance (approx.), 58000 ohms; transconductance, 1200 μmhos; plate ma., 1; peak heater-cathode volts, 90 max. This type is used principally for renewal purposes.

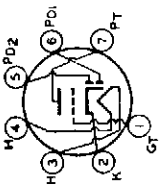

TWIN DIODE—HIGH-MU TRIODE

Glass octal type used as FM detector and audio amplifier in circuits which require diode and triode units with separate cathodes. Outline 14C, OUTLINES SECTION. Tube requires octal socket. Heater volts (ac/dc), 6.3; amperes, 0.3. Ratings and characteristics of triode unit as class A₁ amplifier: plate volts, 250 max; grid volts, -2; amplification factor, 70; plate resistance (approx.), 44000 ohms; transconductance, 1600 μmhos; plate ma., 2.3. This type is used principally for renewal purposes.

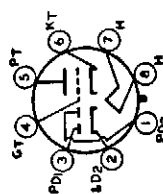

6AQ7GT

HIGH-MU TWIN TRIODE

Miniature type used as rf amplifier and self-oscillating mixer in FM/AM radio receivers. Outline 8B, OUTLINES SECTION. Tube requires nine-contact socket and may be operated in any position. Heater volts (ac/dc), 6.3; amperes, 0.435. With plate volts of 250 and grid volts of -2.3, class A₁ characteristics of each unit are: plate ma, 10; plate resistance (approx.), 9700 ohms; transconductance, 5900 μmhos; amplification factor, 57.

6AQ8

Maximum Ratings, (Design-Center Values, Each Unit):

PLATE VOLTAGE with plate ma = 0.....	550 max	volts
GRID VOLTAGE.....	300 max	volts
GRID VOLTAGE, Negative-bias value.....	-100 max	volts
PLATE DISSIPATION: For either plate.....	2.5 max	watts
For both plates with both units operating.....	4.5 max	watts
CATHODE CURRENT.....	15 max	ma
PEAK HEATER-CATHODE VOLTAGE: Heater negative with respect to cathode.....	90 max	volts
Heater positive with respect to cathode.....	90 max	volts

Typical Operation, (Each Unit):

Plate Supply Voltage.....	250	volts
Plate Voltage.....	250	volts
Plate Resistor.....	1800	ohms
Grid Resistor.....	1	megohm
Grid Voltage.....	-2	volts
RMS Oscillator Voltage.....	3	volts
Cathode Resistor.....	200	ohms
Plate Resistance (Approx.).....	9700	ohms
Transconductance.....	6000	μmhos
Conversion Transconductance.....	2300	μmhos
Input Resistance at frequency (Mc) = 100.....	15000	ohms
Plate Current.....	10	ma
Equivalent Noise Resistance.....	500	ohms

Maximum Circuit Values, (Each Unit):

Grid-Circuit Resistance.....	1 max	megohm
Resistance between Cathode and Heater.....	20000 max	ohms

POWER PENTODE

Miniature type used as output tube primarily in automobile receivers and ac-operated receivers. Outline 7C, OUTLINES SECTION. Tube requires miniature seven-contact socket and may be mounted in any position. Heater volts (ac/dc), 6.3; amperes, 0.4. Maximum ratings as class A₁ amplifier: plate and grid-No.2 (screen-grid) volts, 250 max; plate dissipation, 8.5 max watts; grid-No.2 input, 2.3 max watts; peak heater-cathode volts, 90 max. Within its maximum ratings, type 6AR5 is equivalent in performance to glass-octal type 6K6-GT. Type 6AR5 is used principally for renewal purposes.

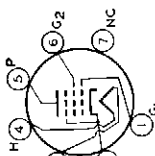

SEMIREMOTE-CUTOFF TWIN PENTODE

Duodecar type used as if-amplifier tube in television receivers. Outline 12A, OUTLINES SECTION. Tube requires duodecar twelve-contact-socket and may be mounted in any position. Heater volts (ac/dc), 6.3; amperes, 0.8.

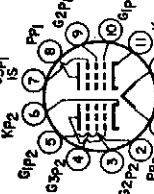

6AR11

Related types: 11AR11

CLASS A₁ AMPLIFIER

Values for each unit

Maximum Ratings, (Design-Maximum Values):

PLATE VOLTAGE.....	330 max	volts
GRID-NO.3 (SUPPRESSOR-GRID) VOLTAGE, Positive value.....	0 max	volts
GRID-NO.2 (SCREEN-GRID) SUPPLY VOLTAGE, (SCREEN-GRID) SUPPLY VOLTAGE.....	330 max	volts
GRID-NO.2 VOLTAGE.....	0 max	volts
GRID-NO.1 (CONTROL-GRID) VOLTAGE, Positive-bias value.....	0 max	volts
GRID-NO.2 INPUT: For grid-No.2 voltages up to 165 volts.....	0.65 max	watt
For grid-No.2 voltages between 165 and 330 volts.....	.See curve page 70	
PLATE DISSIPATION: For grid-No.2 voltages up to 165 volts.....	3.1 max	watts
PEAK HEATER-CATHODE VOLTAGE: Heater negative with respect to cathode.....	200 max	volts
Heater positive with respect to cathode.....	200*max	volts

Characteristics, (Each Unit):

Plate Supply Voltage.....	125	volts
Grid No.3.....	Connected to cathode at socket	
Grid-No.2 Supply Voltage.....	125	volts
Cathode-Bias Resistor.....	56	ohms
Plate Resistance (Approx.).....	0.2	megohm
Transconductance.....	10500	μmhos
Plate Current.....	11	ma
Grid-No.2 Current.....	3.5	ma
Grid-No.1 Voltage (Approx.) for transconductance of 50 μmhos.....	-15	volts

* The dc component must not exceed 100 volts.

BEAM POWER TUBE

Miniature type used as output amplifier primarily in automobile and in ac-operated receivers. Outline 7C, OUTLINES SECTION. Tube requires miniature seven-contact socket and may be mounted in any position. For curves of average plate characteristics, refer to type 35C5.

6AS5

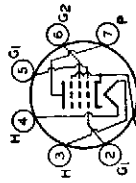

HEATER VOLTAGE (AC/DC)	6.3	volts
HEATER CURRENT	0.8	ampere
DIRECT INTERELECTRODE CAPACITANCES (Approx.):		pf
Grid No.1 to Plate	0.6	pf
Grid No.1 to Cathode, Heater, Grid No.2, and Grid No.3	12	pf
Plate to Cathode, Heater, Grid No.2, and Grid No.3	9.0	pf

CLASS A₁ AMPLIFIER

Maximum Ratings, (Design-Center Values):		
PLATE VOLTAGE	150 maz	volts
GRID-NO.2 (SCREEN-GRID) VOLTAGE	117 maz	volts
PLATE DISSIPATION	5.6 maz	watts
GRID-NO.2 INPUT	1.0 maz	watt
PEAK HEATER-CATHODE VOLTAGE:		
Heater negative with respect to cathode	100 maz	volts
Heater positive with respect to cathode	100 maz	volts
BULB TEMPERATURES (At hottest point)	250 maz	°C

Typical Operation:

Plate Voltage	150	volts
Grid-No.2 Voltage	110	volts
Grid-No.1 (Control-Grid) Voltage	-8.5	volts
Peak AF Grid-No.1 Voltage	8.5	volts
Zero-Signal Plate Current	38	ma
Maximum-Signal Plate Current	56	ma
Zero-Signal Grid-No.2 Current (Approx.)	8.2	ma
Maximum-Signal Grid-No.2 Current (Approx.)	8.5	ma
Transconductance	8800	μmhos
Load Resistance	4500	ohms
Total Harmonic Distortion	10	per cent
Maximum-Signal Power Output	2.2	watts

Maximum Circuit Values:

Grid-No.1-Circuit Resistance:	0.1 maz	megohm
For fixed-bias operation	0.5 maz	megohm
For cathode-bias operation		

DIODE—

SHARP-CUTOFF PENTODE

Miniature type used in diversified applications in television and radio receivers. The pentode unit is used as an if amplifier, video amplifier, or agc amplifier. The high-perveance diode is used as an audio detector, video detector, or dc restorer. Outline 8B, OUTLINES SECTION. Tube requires miniature nine-contact socket and may be mounted in any position.

6AS8

Related type: 5AS8

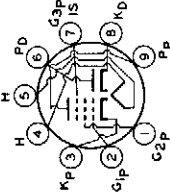

HEATER VOLTAGE (AC/DC)	6.3	volts
HEATER CURRENT	0.45	ampere
DIRECT INTERELECTRODE CAPACITANCES:		
Diode Unit:	3.0	pf
Plate to Cathode, Heater, Pentode Grid No.3, and Internal Shield		
Pentode Unit:		
Grid No.1 to Plate	0.08 maz	pf
Grid No.1 to Cathode, Heater, Grid No.2, Grid No.3, and Internal Shield	7	pf
Plate to Cathode, Heater, Grid No.2, Grid No.3, and Internal Shield	2.4	pf
Pentode Grid No.1 to Diode Plate	0.005 maz	pf
Pentode Plate to Diode Cathode	0.15 maz	pf
Pentode Plate to Diode Plate	0.10 maz	pf

PENTODE UNIT AS CLASS A₁ AMPLIFIER

Maximum Ratings, (Design-Center Values):

PLATE VOLTAGE	300 maz	volts
GRID-NO.3 (SUPPRESSOR-GRID) VOLTAGE, Positive value	0 maz	volts
GRID-NO.2 SUPPLY VOLTAGE	300 maz	volts
GRID-NO.2 (SCREEN-GRID) VOLTAGE	See curve page 70	volts
GRID-NO.1 (CONTROL-GRID) VOLTAGE, Positive bias value	0 maz	volts
PLATE DISSIPATION	2.5 maz	watts
GRID-NO.2 INPUT:		
For grid-No.2 voltages up to 150 volts	0.5 maz	watt
For grid-No.2 voltages between 150 and 300 volts	See curve page 70	volts
PEAK HEATER-CATHODE VOLTAGE:		
Heater negative with respect to cathode	200 maz	volts
Heater positive with respect to cathode	200 ^o maz	volts

Characteristics:

Plate Supply Voltage	200	volts
Grid No.3 and Internal Shield	Connected to cathode at socket	
Grid-No.2 Supply Voltage	150	volts
Cathode-Bias Resistor	180	ohms
Plate Resistance (Approx.)	300000	ohms
Transconductance	6200	μmhos
Grid-No.1 Voltage (Approx.) for plate current of 10 μa	8	volts
Plate Current	9.5	ma
Grid-No.2 Current	3	ma

Maximum Circuit Values:

Grid-No.1-Circuit Resistance:	0.25 maz	megohm
For fixed-bias operation	1.0 maz	megohm
For cathode-bias operation		
*The dc component must not exceed 100 volts.		

DIODE UNIT

Maximum Ratings, (Design-Center Values):

PEAK INVERSE PLATE VOLTAGE	350 maz	volts
PEAK PLATE CURRENT	50 maz	ma
DC PLATE CURRENT	5 maz	ma
PEAK HEATER-CATHODE VOLTAGE:		
Heater negative with respect to cathode	200 maz	volts
Heater positive with respect to cathode	200 ^o maz	volts
*The dc component must not exceed 100 volts.		

DUAL TRIODE— SHARP-CUTOFF PENTODE

Duodecar type used in television receivers. High-μu triode is used in audio if-amplifier service; medium-μu triode is used in sync-separator service; pentode is used in video amplifier service. Outline 12B, OUTLINES SECTION. Tube requires 12-contact socket and may be mounted in any position. Heater voltage (ac/dc), 6.3; amperes, 1.05.

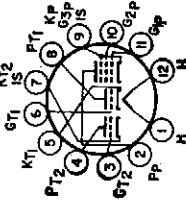

6AS11

CLASS A₁ AMPLIFIER

Maximum Ratings, (Design-Maximum Values):		
PLATE VOLTAGE	380 maz	volts
GRID-NO.2 (SCREEN-GRID) SUPPLY VOLTAGE	330 maz	volts
GRID-NO.2 VOLTAGE	See curve page 70	volts
GRID-NO.1 (CONTROL-GRID) VOLTAGE, Positive-bias value	0 maz	volts
GRID-NO.2 INPUT:		
For grid-No.2 voltages up to 165 volts	1.1 maz	watts
For grid-No.2 voltages between 165 and 380 volts	See curve page 70	watts
PEAK HEATER-CATHODE VOLTAGE:		
Heater negative with respect to cathode	200 maz	volts
Heater positive with respect to cathode	200 ^o maz	volts

Characteristics:

Plate Supply Voltage	200	200	volts
Grid-No.2 Supply Voltage	-2	125	volts
Grid Voltage	-	68	ohms
Cathode-Bias Resistor	88	41	
Amplification Factor	12400	70000	ohms
Plate Resistance (Approx.)			153

Transconductance.....	5500	4400	10500	μmhos
Plate Current.....	7	9.2	24	ma
Grid-No.2 Current.....	-	-	5.2	ma
Grid-No.1 Voltage (Approx.):	-5.5	-6.5	-	volts
For plate current of 10 μa:	-	-	-8	volts
For plate current of 100 μa:	-	-	-	volts
Maximum Circuit Values, (Each Unit):				
Grid-No.1-Circuit Resistance:	0.5 maz	0.5 maz	0.25 maz	megohm
For fixed-bias operation.....	1 maz	1 maz	1 maz	megohm
For cathode-bias operation.....	-	-	-	-

* The dc component must not exceed 100 volts.

TWIN DIODE—HIGH-MU TRIODE

6AT6
 Related type: 12A76

Miniature type used as a combined detector, amplifier, and avc tube in automobile and ac-operated radio receivers. Outline 7B, OUTLINES SECTION. Tube requires miniature seven-contact socket and may be mounted in any position. For typical operation as resistance-coupled amplifier, refer to RESISTANCE-COUPLED AMPLIFIER SECTION.

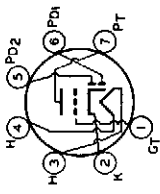

HEATER VOLTAGE (AC/DC).....	6.3	volts
HEATER CURRENT.....	0.3	ampere
DIRECT INTERELECTRODE CAPACITANCES:		
Triode Grid to Triode Plate.....	2.0	pf
Triode Grid to Cathode and Heater.....	2.2	pf
Triode Plate to Cathode and Heater.....	0.8	pf
Plate of Diode Unit No.2 to Triode Grid.....	0.04 maz	pf

TRIODE UNIT AS CLASS A₁ AMPLIFIER

Maximum Ratings, (Design-Center Values):		
PLATE VOLTAGE.....	300 maz	volts
HEATER CURRENT.....	0.5 maz	volts
GRID VOLTAGE, Positive-bias value.....	0 maz	volts
PEAK HEATER-CATHODE VOLTAGE:		
Heater negative with respect to cathode.....	90 maz	volts
Heater positive with respect to cathode.....	90 maz	volts
Characteristics:		
Plate Voltage.....	100	volts
Grid Voltage.....	70	volts
Amplification Factor.....	54000	ohms
Plate Resistance.....	1300	μmhos
Transconductance.....	0.8	ma
Plate Current.....	-	-

DIODE UNITS

Maximum Rating, (Design-Center Value):		
PLATE CURRENT (Each Unit).....	1.0 maz	ma

The two diode plates are placed around a cathode, the sleeve of which is common to the triode unit. Each diode plate has its own base pin. For diode operation curves, refer to type 6AV6.

MEDIUM-MU TRIODE—SHARP-CUTOFF PENTODE

6AT8
 Related type: 5AT8

Miniature types used as combined oscillator and mixer tubes in television receivers utilizing an intermediate frequency in the order of 40 megacycles per second. Type 6AT8-A has a controlled heater warm-up time for use in receivers employing series-connected heater strings. Outline 8B, OUTLINES SECTION. Except for interelectrode capacitances and basing arrangement, these types are identical with miniature type 6X8. The basing arrangement of the 6AT8 and 6AT8-A is particularly suitable for connection to the coils of certain designs of turret tuners. Type 6AT8 is a DISCONTINUED type listed for reference only.

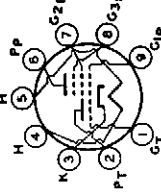

HEATER VOLTAGE (AC/DC).....	6.3	volts
HEATER CURRENT.....	0.45	ampere
HEATER WARM-UP TIME (Average) for 6AT8-A.....	11	seconds

DIRECT INTERELECTRODE CAPACITANCES:

Triode Unit:		
Grid to Plate.....	1.5	pf
Grid to Cathode and Heater.....	2.0	pf
Plate to Cathode and Heater.....	0.5	pf
Pentode Unit:		
Grid No.1 to Plate.....	0.06 maz	pf
Grid No.1 to Cathode, Heater, Grid No.2, and Grid No.3.....	4.6	pf
Plate to Cathode, Heater, Grid No.2, and Grid No.3.....	4.8	pf
Pentode Grid No.1 to Triode Plate.....	0.05 maz	pf
Pentode Plate to Triode Plate.....	0.03 maz	pf
Heater to Cathode.....	6.0	pf

† With external shield connected to cathode except as noted.
 ‡ With external shield connected to plate.

HALF-WAVE VACUUM RECTIFIER

Glass octal types used as damper tubes in horizontal-deflection circuits of color television receivers and of television receivers utilizing picture tubes having wide-angle deflection. Outline 14F, OUTLINES SECTION. Tubes require octal socket and may be mounted in any position. These types may be supplied with pin No.1 omitted. Socket terminals 1, 2, 4, and 6 should not be used as tie points. It is especially important that these tubes, like other power-handling tubes, be adequately ventilated. Type 6AU4-GT is a DISCONTINUED type listed for reference only.

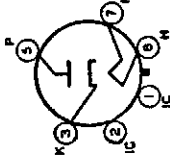

6AU4GT
6AU4GTA

HEATER VOLTAGE (AC/DC).....	6.3	volts
HEATER CURRENT.....	1.8	ampere
DIRECT INTERELECTRODE CAPACITANCES (Approx.):		
Plate to Heater and Cathode.....	8.5	pf
Cathode to Heater and Plate.....	11.5	pf
Heater to Cathode.....	4.0	pf

DAMPER SERVICE

For operation in a 525-line, 30-frame system

Maximum Ratings:		
PEAK INVERSE PLATE VOLTAGE.....	4500* maz	volts
PEAK PLATE CURRENT.....	1050 maz	ma
DC PLATE CURRENT.....	175 maz	ma
PLATE DISSIPATION.....	6 maz	watts
PEAK HEATER-CATHODE VOLTAGE:		
Heater negative with respect to cathode.....	4500* maz	volts
Heater positive with respect to cathode.....	300† maz	volts

* The duration of the voltage pulse must not exceed 15 per cent of one horizontal scanning cycle. In a 525-line, 30-frame system, 10 per cent of one horizontal scanning cycle is 10 microseconds.
 † Absolute Maximum. Under no circumstances should this absolute value be exceeded.
 * The dc component must not exceed 100 volts.
 ‡ The dc component must not exceed 100 volts.

BEAM POWER TUBE

Glass octal type used as horizontal deflection amplifier in low-cost, high-efficiency deflection circuits of television receivers employing either transformer coupling or direct coupling to the deflecting yoke. Outline 14C, OUTLINES SECTION. Tube requires octal socket and may be mounted in any position.

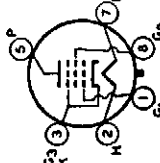

HEATER VOLTAGE (AC/DC).....	6.3	volts
HEATER CURRENT.....	1.25	ampere
DIRECT INTERELECTRODE CAPACITANCES (Approx.):		
Grid No.1 to Plate.....	0.5	pf
Grid No.1 to Cathode, Heater, Grid No.2, and Grid No.3.....	11.3	pf
Plate to Cathode, Heater, Grid No.2, and Grid No.3.....	7.0	pf
TRANSCONDUCTANCE#.....	5600	μmhos
MU-FACTOR, Grid No.2 to Grid No.1†.....	5.9	-

For plate volts, 115; grid-No.2 volts, 175; grid-No.1 volts, -20.
 † For plate volts, 100; grid-No.2 volts, 100; grid-No.1 volts, -4.5.

HORIZONTAL DEFLECTION AMPLIFIER
For operation in a 525-line, 30-frame system

Maximum Ratings, (Design-Center Values):	
DC PLATE VOLTAGE.....	550 maz
PEAK POSITIVE-PULSE PLATE VOLTAGE* (Absolute Maximum)	5500 [†] maz
PEAK NEGATIVE-PULSE PLATE VOLTAGE.....	-1250 maz
DC GRID-NO.2 (SCREEN-GRID) VOLTAGE*	200 maz
PEAK NEGATIVE-PULSE GRID-NO.1 (CONTROL-GRID) VOLTAGE.....	-300 maz
PEAK CATHODE CURRENT.....	400 maz
AVERAGE CATHODE CURRENT.....	110 maz
GRID-NO.2 INPUT.....	2.5 maz
PLATE DISSIPATION††.....	10 maz
PEAK HEATER-CATHODE VOLTAGE.....	200 maz
Heater negative with respect to cathode.....	200maz
Heater positive with respect to cathode.....	210 maz
BULB TEMPERATURE (At hottest point).....	°C

Maximum Circuit Value:

- Grid-No.1-Circuit Resistance..... 0.47 maz megohm
- * The duration of the voltage pulse must not exceed 15 per cent of one horizontal scanning cycle. In a 525-line, 30-frame system, 15 per cent of one horizontal scanning cycle is 10 microseconds.
- † Under no circumstances should this absolute value be exceeded.
- * Obtained through a series dropping resistor of sufficient magnitude to limit the grid-No.2 input to the rated maximum value.
- †† An adequate bias resistor or other means is required to protect the tube in the absence of excitation.
- ‡ The dc component must not exceed 100 volts.

6AU6

6AU6A

Related types:
3AU6, 4AU6, 12AU6



SHARP-CUTOFF PENTODE

Miniature types used in compact radio equipment as rf amplifier especially in high-frequency, wide-band applications; also used as limiter tube in FM equipment. Type 6AU6-A has a controlled heater warm-up time for use in applications employing series-connected heater strings. Outline 7B, OUTLINES SECTION. Tubes require miniature seven-contact socket and may be operated in any position. For a discussion of limiters, refer to ELECTRON TUBE APPLICATIONS SECTION. For typical operation as resistance-coupled amplifier, refer to RESISTANCE-COUPLED AMPLIFIER SECTION. Type 6AU6 is a DISCONTINUED type listed for reference only.

HEATER VOLTAGE (AC/DC).....	6.3	volts
HEATER CURRENT.....	0.3	ampere
HEATER WARM-UP TIME (Average) for 6AU6-A.....	11	seconds

DIRECT INTERELECTRODE CAPACITANCES:

Pentode Connection:		
Grid No.1 to Cathode.....	0.0035 maz	0.0035 maz pf
Grid No.1 to Plate.....	5.5	5.5 pf
Plate to Cathode, Heater, Grid No.2, Grid No.3, and Internal Shield.....	5.0	5.0 pf

Triode Connection:†

Grid No.1 to Plate, Grid No.2, Grid No.3, and Internal Shield.....	2.6	2.6 pf
Grid No.1 to Cathode and Heater.....	3.2	3.2 pf
Plate, Grid No.2, Grid No.3, and Internal Shield to Cathode and Heater.....	1.2	8.5 pf

- ‡ With external shield connected to cathode.
- † Grid No.2, grid No.3, and internal shield connected to plate.

CLASS A₁ AMPLIFIER

(Design-Maximum Values):

Maximum Ratings, (Design-Maximum Values):	
PLATE VOLTAGE.....	330 maz
GRID-NO.3 (SUPPRESSOR-GRID) VOLTAGE, Positive value.....	0 maz
GRID-NO.2 (SCREEN-GRID) VOLTAGE.....	See curve page 70
GRID-NO.2 SUPPLY VOLTAGE.....	330 maz
PLATE DISSIPATION.....	3.5 maz

GRID-NO.2 INPUT:
For grid-No.2 voltages up to 165 volts.....
For grid-No.2 voltages between 165 and 330 volts.....

Grid-No.1 (CONTROL-GRID) VOLTAGE:	0 maz	0 maz	volts
Positive-bias value.....	200 maz	200 [†] maz	volts
Heater negative with respect to cathode.....	200 [†] maz	200 [†] maz	volts

PEAK HEATER-CATHODE VOLTAGE:

Heater positive with respect to cathode.....

Characteristics:

Plate Supply Voltage.....	100	250	250	volts	
Grid No.3 Supply Voltage.....	Connected to cathode at socket.	100	125	150	volts
Grid No.2 Supply Voltage.....	330	150	100	68	ohms
Cathode-Bias Resistor.....	36	—	—	—	—
Amplification Factor.....	4800	0.5	1.5	1.0	megohms
Plate Resistance (Approx.).....	3900	4500	4500	5200	ohms
Transconductance.....	-4.2	-5.5	-6.5	-6.5	volts
Grid-No.1 Voltage for plate current of 10 μ A.....	12.2	5.0	7.6	10.5	ma
Plate Current.....	—	2.1	3.0	4.3	ma

- † Grid No.2, grid No.3, and internal shield connected to plate.
- ‡ The dc component must not exceed 100 volts.

AVERAGE CHARACTERISTICS

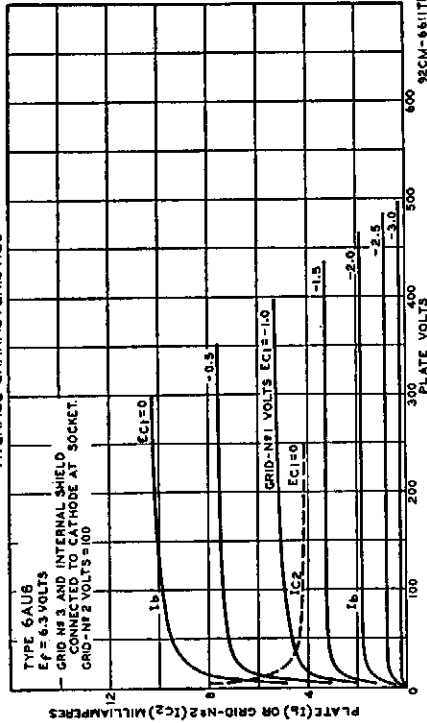

MEDIUM-MU TWIN TRIODE

Miniature type used as phase inverter or amplifier in television receivers employing series-connected heater strings. Outline 8B, OUTLINES SECTION. Heater volts (ac/dc), 6.3 (series), 3.15 (parallel); amperes, 0.3 (series), 0.6 (parallel); warm-up time (average) in parallel arrangement, 11 seconds. Except for heater and heater-cathode ratings, this type is identical with miniature type 12AU7. The 6AU7 is a DISCONTINUED type listed for reference only.

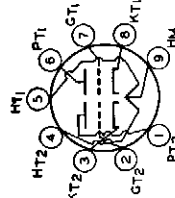

MEDIUM-MU TRIODE—SHARP-CUTOFF PENTODE

Miniature types used in television receiver applications. Tubes have controlled heater warm-up time for use in series-heater strings. Pentode unit is used as video amplifier, if amplifier, age amplifier. Triode unit is used in sync-amplifier, sync-separator, sync-clipper, and phase-inverter circuits. Outline 8D, OUTLINES SECTION. Tubes require nine-contact socket and may be mounted in any position. Type 6AU8 is a DISCONTINUED type listed for reference only.

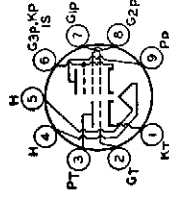

6AU8
6AU8A

Related type:
8AU8

HEATER VOLTAGE (AC/DC)	6.3	volts
HEATER CURRENT	0.6	amperes
HEATER WARM-UP TIME (Average)	11	seconds
DIRECT INTERELECTRODE CAPACITANCES:		
Triode Unit:		
Grid to Cathode	2.2	pf
Grid to Heater	2.6	pf
Plate to Cathode and Heater	0.34	pf
Pentode Unit:		
Grid No.1 to Plate	0.06	pf
Grid No.1 to Cathode, Heater, Grid No.3, and Internal Shield	7.5	pf
Plate to Cathode, Heater, Grid No.2, Grid No.3, and Internal Shield	3.4	pf
Triode Grid to Pentode Plate	0.022	max
Pentode Grid No.1 to Triode Plate	0.002	max
Pentode Plate to Triode Plate	0.12	max

Maximum Ratings, (Design-Maximum Values):

PLATE VOLTAGE	330 max	Pentode Unit
GRID-NO.2 (SCREEN-GRID) SUPPLY VOLTAGE	330 max	volts
GRID-NO.2 VOLTAGE	See curve	page 70
GRID-NO.1 (CONTROL-GRID) VOLTAGE, Positive-bias value	0 max	volts
PLATE DISSIPATION	3.3 max	watts
GRID-NO.2 INPUT	1 max	watt
For grid-No.2 voltages up to 165 volts	See curve	page 70
PEAK HEATER-CATHODE VOLTAGE	200 max	volts
Heater negative with respect to cathode	200 max	volts
Heater positive with respect to cathode	200 max	volts

Characteristics:

Plate Supply Voltage	150	Triode Unit	200	Pentode Unit
Grid-No.2 Supply Voltage	—	125	volts	
Cathode-Bias Resistor	150	82	ohms	
Amplification Factor	43	—		
Plate Resistance (Approx.)	8100	10000	ohms	
Transconductance	5300	8000	μmhos	
Grid-No.1 Voltage (Approx.) for plate current of 100 μa	-6.5	-7.5	volts	
Plate Current	9.5	17	ma	
Grid-No.2 Current	—	3.4	ma	

Maximum Circuit Values:

Grid-No.1-Circuit Resistance:	0.25 max	megohm
For fixed-bias operation	1.0 max	megohm
For cathode-bias operation	1.0 max	megohm

■ The dc component must not exceed 100 volts.

6AV5GA

6AV5GT

Related types:

12AV5GA, 25AV5GA

BEAM POWER TUBE

Glass octal types used as horizontal deflection amplifiers in television receivers employing either transformer coupling or direct coupling to the deflecting yoke. 6AV5-GA Outline 19B, 6AV5-GT Outline 14C, OUTLINES SECTION. Tubes require octal socket and may be mounted in any position. Type 6AV5-GT is a DISCONTINUED type listed for reference only.

HEATER VOLTAGE (AC/DC)	6.3	volts
HEATER CURRENT	1.2	amperes
TRANSCONDUCTANCE*	5900	μmhos
MU FACTOR, Grid No.2 to Grid No.1**	4.3	

* Plate volts, 250; grid-No.2 volts, 150; grid-No.1 volts, -22.5.
** Triode connected; plate and grid-No.2 volts, 150; grid-No.1 volts, -22.5.

HORIZONTAL DEFLECTION AMPLIFIER

For operation in a 585-line, 50-frame system

Maximum Ratings, (Design-Center Values):

DC PLATE VOLTAGE	550 max	volts
PEAK POSITIVE-PULSE PLATE VOLTAGE† (Absolute Maximum)	5500* max	volts
PEAK NEGATIVE-PULSE PLATE VOLTAGE	-1250 max	volts
DC GRID-NO.2 (SCREEN-GRID) VOLTAGE	-175 max	volts
PEAK NEGATIVE-PULSE GRID-NO.1 (CONTROL-GRID) VOLTAGE	-300 max	volts

PEAK CATHODE CURRENT	400 max	ma
AVERAGE CATHODE CURRENT	110 max	ma
GRID-NO.2 INPUT	2.5 max	watts
PLATE DISSIPATION††	11 max	watts
PEAK HEATER-CATHODE VOLTAGE:		
Heater negative with respect to cathode	200 max	volts
Heater positive with respect to cathode	200 max	volts
BULB TEMPERATURE (At hottest point)	210 max	°C

Maximum Circuit Value:

Grid-No.1 Circuit Resistance	0.47 max	megohm
------------------------------	----------	--------

† The duration of the voltage pulse must not exceed 15 per cent of one horizontal scanning cycle. In a 525-line, 30-frame system, 15 per cent of one horizontal scanning cycle is 10 microseconds.

†† Under no circumstances should this absolute value be exceeded.
‡ An adequate bias resistor or other means is required to protect the tube in the absence of excitation.
■ The dc component must not exceed 100 volts.

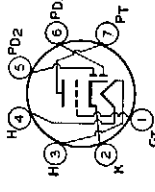

TWIN DIODE-HIGH-MU TRIODE

Miniature type used as combined detector, amplifier, and AVC tube in automobile and ac-operated radio receivers. The 6AV6 may be substituted directly for the 6AT6 in applications where the higher amplification of the 6AV6 is advantageous.

HEATER VOLTAGE (AC/DC)	6.3	volts
HEATER CURRENT	0.3	ampere

Without External Shield

DIRECT INTERELECTRODE CAPACITANCES:

Triode Grid to Triode Plate	2.0	pf
Triode Grid to Cathode and Heater	2.2	pf
Triode Plate to Cathode and Heater	2.2	pf
Plate of Diode Unit No.2 to Triode Grid	0.8	pf
With external shield connected to cathode	0.04 max	pf

TRIODE UNIT AS CLASS A₁ AMPLIFIER

Maximum Rating, (Design-Maximum Value):

GRID VOLTAGE, Positive-bias value	330 max	volts
PLATE DISSIPATION	0 max	watt
PEAK HEATER-CATHODE VOLTAGE:		
Heater negative with respect to cathode	200 max	volts
Heater positive with respect to cathode	200 max	volts

Characteristics:

Plate Voltage	100	volts
Grid Voltage	-1	volts
Amplification Factor	100	

AVERAGE PLATE CHARACTERISTICS

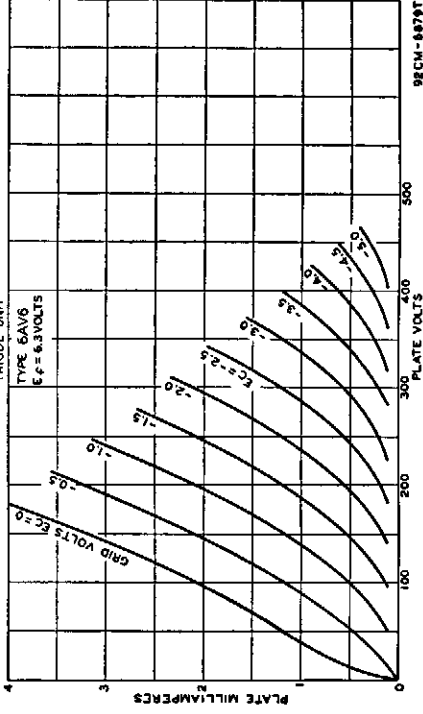

Plate Resistance.....	80000	62500	ohms
Transconductance.....	1250	1600	μmhos
Plate Current.....	0.50	1.2	ma

DIODE UNITS

Maximum Rating, (Design-Maximum Value):

PLATE CURRENT (Each Unit).....	1.0	ma
--------------------------------	-----	----

* The dc component must not exceed 100 volts.
 The two diode plates are placed around a cathode, the sleeve of which is common to the triode unit. Each diode plate has its own base pin. Diode biasing of the triode unit is not recommended.

INSTALLATION AND APPLICATION

Type 6AV6 requires miniature seven-contact socket and may be mounted in any position. Outline 7B, OUTLINE SECTION.

The triode unit of the 6AV6 is recommended for use only in resistance-coupled circuits. Refer to the RESISTANCE-COUPLED AMPLIFIER SECTION for typical operating conditions.

Grid bias for the triode unit of the 6AV6 may be obtained from a fixed source, such as a fixed-voltage tap on the dc power supply, or from a cathode-bias resistor. It should not be obtained by the diode-biasing method because of the probability of plate-current cutoff, even with relatively small signal voltages applied to the diode circuit.

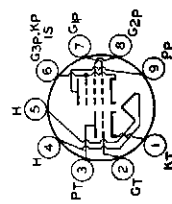
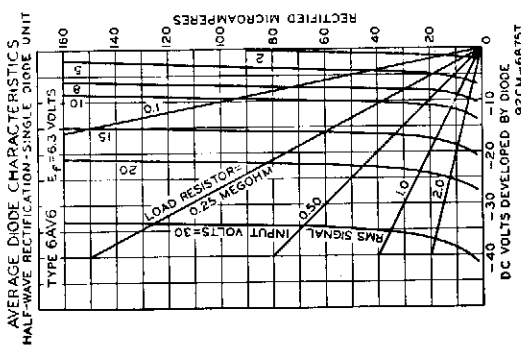

6AW8 HIGH-MU TRIODE—SHARP-CUTOFF PENTODE

6AW8A

Related type: 6AW8A

Miniature types used in a wide variety of applications in television receivers. These types have a controlled heater warm-up time for use in receivers employing series-connected

heater strings. The pentode unit is used as an if amplifier, video amplifier, agc amplifier, or reactance tube. The triode unit is used in low-frequency oscillator, sync-separator, sync-clipper, and phase-splitter circuits. Outline 8D, OUTLINES SECTION. Tubes require miniature nine-contact socket and may be mounted in any position. Type 6AW8 is a discontinued type listed for reference only.

HEATER VOLTAGE (AC/DC).....	6.3	volts
HEATER CURRENT.....	0.6	ampere
HEATER WARM-UP TIME (AVERAGE).....	11	seconds

DIRECT INTERELECTRODE CAPACITANCES:

Triode Unit:	Without External Shield*	With External Shield*	pf
Grid to Plate.....	2.2	2.2	pf
Grid to Cathode, Pentode Grid No.3, Internal Shield, and Heater.....	3.2	3.4	pf
Plate to Cathode, Pentode Cathode, Pentode Grid No.3, Internal Shield, and Heater.....	1.8	3.0	pf
Pentode Unit:			
Grid No.1 to Plate.....	0.06	0.05	maz
Grid No.1 to Cathode, Heater, Grid No.2, Grid No.3, and Internal Shield.....	10	10	pf
Plate to Cathode, Heater, Grid No.2, Grid No.3, and Internal Shield.....	3.6	4.5	pf
Pentode Grid No.1 to Triode Plate.....	0.008	0.005	maz
Pentode Plate to Triode Plate.....	0.15	0.025	maz

* With external shield connected to pins 4 and 5.

AVERAGE CHARACTERISTICS TRIODE UNIT

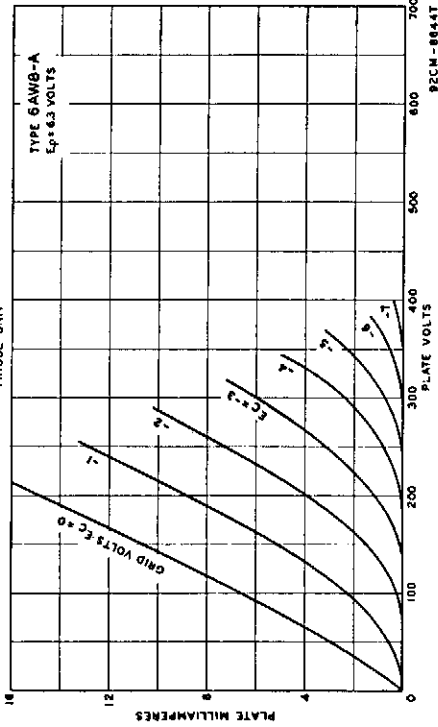

CLASS A₁ AMPLIFIER

Maximum Ratings, (Design-Maximum Values):

PLATE VOLTAGE.....	330	maz	Pentode Unit	330	maz	330	maz	330	maz
GRID-NO.2 (SCREEN-GRID) SUPPLY VOLTAGE.....	—	—	—	—	—	—	—	—	—
GRID-NO.2 VOLTAGE.....	—	—	—	—	—	—	—	—	—
GRID-NO.1 (CONTROL-GRID) VOLTAGE:									
Positive bias value.....	0	maz	0	maz	0	maz	0	maz	0
PLATE DISSIPATION.....	1.1	maz	1.1	maz	1.1	maz	1.1	maz	1.1
GRID-NO.2 INPUT.....	—	—	—	—	—	—	—	—	—
For Grid-No.2 voltages up to 165 volts.....	—	—	—	—	—	—	—	—	—
For Grid-No.2 voltages between 165 and 330 volts.....	—	—	—	—	—	—	—	—	—
PEAK HEATER-CATHODE VOLTAGE:									
Heater positive with respect to cathode.....	200	maz	200	maz	200	maz	200	maz	200
Heater negative with respect to cathode.....	200	maz	200	maz	200	maz	200	maz	200

Characteristics:

Plate Supply Voltage.....	200	Volts	Pentode Unit	150	Volts
Grid-No.2 Supply Voltage.....	—	—	—	150	Volts
Grid-No.1 Voltage.....	-2	Volts	—	—	—
Cathode-Bias Resistor.....	—	—	—	150	ohms
Amplification Factor.....	70	—	—	0.2	megohm
Plate Resistance (Approx.).....	4000	—	—	9500	—
Transconductance.....	-5	—	—	-8	—
Grid-No.1 Voltage (Approx.) for plate current of 20 μa.....	—	—	—	—	—

AVERAGE CHARACTERISTICS PENTODE UNIT

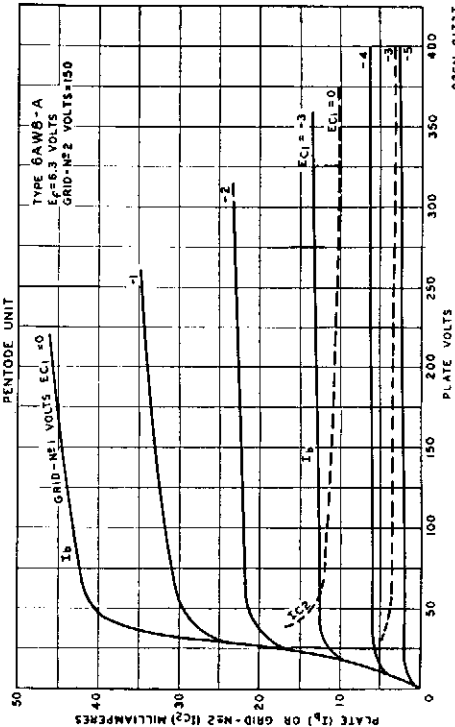

Characteristics:

Plate Supply Voltage	200	volts
Grid-No.2 Voltage	150	volts
Grid-No.1 Voltage	-6	volts
Cathode-Bias Resistor	180	ohms
Amplification Factor	19	ohms
Plate Resistance (Approx.)	5750	ohms
Transconductance	3800	μmhos
Grid-No.1 Voltage (Approx.) for plate current of 10 μa	-19	volts
Grid-No.2 Voltage (Approx.) for transconductance of 100	-12.5	volts
Plate Current	9.5	ma
Grid-No.2 Current	3	ma

Maximum Circuit Values:

Grid-No.1-Circuit Resistance*	0.25 maz	megohm
For fixed-bias operation	1.0 maz	megohm
For cathode-bias operation	1.0 maz	megohm

* The dc component must not exceed 100 volts.
 The heater-cathode voltage should not exceed the value of the operating cathode bias. If the heater-cathode voltage exceeds the operating cathode bias value, grid No.3 will be made negative with respect to cathode, and thus possibly cause a change in tube characteristics.
 * * If either unit is operating at maximum rated conditions, grid-No.1-circuit resistance for both units should not exceed the stated values.

POWER TRIODE

Glass octal type used in output stage of radio receivers and amplifiers. Maximum dimensions: over-all length, 5-5/16 inches; seated height, 4-3/4 inches; diameter, 2-1/16 inches. Tube requires octal socket. For typical operation as a single-tube class A amplifier, refer to type 2A3. Filament volts (ac/dc), 6.3; amperes, 1.0. Maximum ratings as push-pull class AB₁ amplifier: plate volts, 325; plate dissipation, 15 watts. Type 6B4-G is a DISCONTINUED type listed for reference only.

6B4G

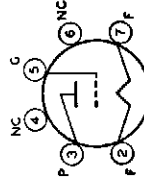

DIRECT-COUPLED POWER TRIODE

Glass type used as class A₁ power amplifier. One triode, the driver, is directly connected within the tube to the second, or output, triode. Outline 27, OUTLINES SECTION. Tube requires six-contact socket. Heater volts (ac/dc), 6.3; amperes, 0.8. Characteristics of input and output triodes as class A₁ amplifier follow. Input triode: plate volts, 300 maz; grid volts, 0; plate volts, 300 maz; plate ma, 45; plate resistance, 24,000 ohms; load resistance, 7000 ohms; output watts, 4. This is a DISCONTINUED type listed for reference only.

6B5

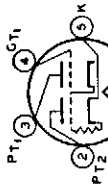

TWIN-DIODE—HIGH-μ TRIODE

Glass octal type used as combined detector, amplifier, and avc tube. Outline 23, OUTLINES SECTION. Tube requires octal socket. Heater volts (ac/dc), 6.3; amperes, 0.3. Within its triode maximum plate-voltage rating of 250 volts, this type is similar electrically to type 6SQ7 and curves under that type apply to the 6B6-G. This is a DISCONTINUED type listed for reference only.

6B6G

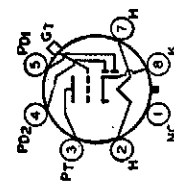

TWIN-DIODE—REMOTE-CUTOFF PENTODE

Glass types used as combined detector, amplifier, and avc tubes. Outline 24B, OUTLINES SECTION. These types fit the small seven-contact (0.75-inch, pin-circle diameter) socket. Except for interelectrode capacitances, the electrical characteristics of the 6B7 are identical with those of type 6B8-G. Type 6B7S has the external shield connected to the cathode. In general, its electrical characteristics are similar to those of the 6B7, but the two types are usually not directly interchangeable. These are DISCONTINUED types listed for reference only.

6B7

6B7S

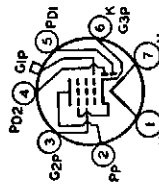

TWIN DIODE—SEMIREMOTE-CUTOFF PENTODE

Metal type 6B8 and glass octal type 6B8-G are used as combined detector, amplifier, and avc tubes. Outlines 3 and 23, respectively, OUTLINES SECTION. Type 6B8 is used principally for renewal purposes; 6B8-G is a DISCONTINUED type listed for reference only. Tubes require octal socket. Heater volts (ac/dc), 6.3; amperes, 0.3. Maximum ratings of pentode unit as class A₁ amplifier: plate volts, 300 maz; grid-No.2 supply volts, 300 maz; grid-No.1 volts, positive-bias value, 0 maz; plate dissipation, 3.0 maz watts (6B8), 2.25 maz watts (6B8-G); grid-No.2 input, 0.3 maz watt.

6B8
6B8G

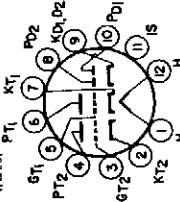

TWIN DIODE—MEDIUM-μ TWIN TRIODE

Duodecar type used in television receivers; diode units are used in horizontal-phase-detector circuits, and triode units are used in horizontal-oscillator circuits. Outline 12A, OUTLINES SECTION. Tube requires duodecar twelve-contact socket and may be mounted in any position. Heater volts (ac/dc), 6.3; amperes, 0.6; warm-up time (average), 11 seconds.

6B10
Related type:
8B10

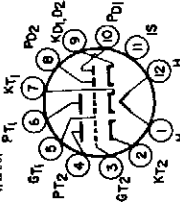

TRIODE UNITS AS CLASS A₁ AMPLIFIER

Values are for each unit

Maximum Ratings, (Design-Maximum Values):		
PLATE VOLTAGE	330 maz	volts
DC CATHODE CURRENT	20 maz	ma
PLATE DISSIPATION	3 maz	watts
PEAK HEATER-CATHODE VOLTAGE:		
Heater positive with respect to cathode	200 maz	volts
Heater negative with respect to cathode	200 ^o maz	volts
Characteristics:		
Plate Voltage	250	volts
Grid Voltage	-8	volts
Amplification Factor	18	
Plate Resistance (Approx.)	7200	ohms
Transconductance	2500	μmhos
Plate Current	10	ma
Grid Voltage (Approx.) for plate current of 50 μa	-20	volts
Maximum Circuit Values:		
Grid-Circuit Resistance:	0.25 maz	megohm
For fixed-bias operation	1 maz	megohm
For cathode-bias operation		
DIODE UNITS (Each Unit)		
Maximum Rating, (Design-Maximum Value):		
PLATE CURRENT	5 maz	ma
PEAK HEATER-CATHODE VOLTAGE:		
Heater negative with respect to cathode	200 maz	volts
Heater positive with respect to cathode	200 ^o maz	volts
Characteristics, Instantaneous Value:		
Tube Voltage Drop for plate current of 20 ma	5	volts
The dc component must not exceed 100 volts.		

HALF-WAVE VACUUM RECTIFIER

Novar type used as damper tube in horizontal-deflection circuits of television receivers. Outline 10B, OUTLINES SECTION. Tube requires novar nine-contact socket and may be mounted in any position. Socket terminals 1, 3, 6, and 8 should not be used as tie

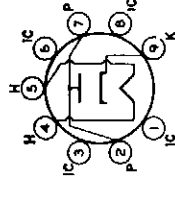

6BA3

points. It is especially important that this tube, like other power-handling tubes, be adequately ventilated.

HEATER VOLTAGE (AC/DC).....	6.3	volts
HEATER CURRENT.....	1.2	amperes
DIRECT INTERELECTRODE CAPACITANCES, (Approx.):		
Plate to Cathode and Heater.....	4.4	pf
Cathode to Plate and Heater.....	6	pf
Heater to Cathode.....	1.8	pf

DAMPER SERVICE

For operation in a 525-line, 30-frame system

Maximum Ratings, (Design-Maximum Values):		
PEAK INVERSE PLATE VOLTAGE.....	5000 ^{max}	volts
PEAK PLATE CURRENT.....	1000 ^{max}	ma
DC PLATE CURRENT.....	165 ^{max}	ma
PLATE DISSIPATION.....	5.3 ^{max}	watts
PEAK HEATER-CATHODE VOLTAGE:		
Heater negative with respect to cathode.....	5000 ^{max}	volts
Heater positive with respect to cathode.....	300 ^{max}	volts
■ The duration of the voltage pulse must not exceed 15 per cent of one horizontal scanning cycle. In a 525-line, 30-frame system, 15 per cent of one horizontal scanning cycle is 10 microseconds.		
* The dc component must not exceed 900 volts.		
† The dc component must not exceed 100 volts.		

REMOTE-CUTOFF PENTODE

Miniature type used as rf amplifier in standard broadcast and FM receivers, as well as in wide-band, high-frequency applications. This type is similar in performance to metal type 6SG7. The low value of grid-No.1-to-plate capacitance minimizes regenerative effects, while the high transconductance makes possible high signal-to-noise ratio.

6BA6

Related types:
38A6, 12BA6



HEATER VOLTAGE (AC/DC).....	6.3	volts
HEATER CURRENT.....	0.3	ampere
DIRECT INTERELECTRODE CAPACITANCES:		
Grid No.1 to Plate.....	Without External Shield	0.0085 maz
Grid No.1 to Cathode, Heater, Grid No.2, Grid No.3, and Internal Shield.....	5.5	5.5
Plate to Cathode, Heater, Grid No.2, Grid No.3, and Internal Shield.....	5.0	5.5
■ With external shield connected to cathode.		

CLASS A₁ AMPLIFIER

Maximum Ratings, (Design-Maximum Values):

PLATE VOLTAGE.....	330 maz	volts
GRID-NO.3 (SUPPRESSOR-GRID) VOLTAGE, Positive value.....	0 maz	volts
GRID-NO.2 (SCREEN-GRID) VOLTAGE.....	See curve page 70	volts
GRID-NO.2 SUPPLY VOLTAGE.....	330 maz	volts
PLATE DISSIPATION.....	3.4 maz	watts
GRID-NO.2 INPUT:		
For grid-No.2 voltages up to 165 volts.....	0.7 maz	watt
For grid-No.2 voltages between 165 and 330 volts.....	See curve page 70	
GRID-NO.1 (CONTROL-GRID) VOLTAGE:		
Negative bias value.....	-55 maz	volts
Positive bias value.....	0 maz	volts
PEAK HEATER-CATHODE VOLTAGE:		
Heater negative with respect to cathode.....	200 maz	volts
Heater positive with respect to cathode.....	200 ^{max}	volts
* The dc component must not exceed 100 volts.		

Characteristics:

Plate Supply Voltage.....	100	volts
Grid No.3 and Internal Shield.....	Connected to cathode at socket	
Grid-No.2 Supply Voltage.....	100	volts
Cathode-Bias Resistor.....	68	ohms
Plate Resistance (Approx.).....	0.25	1.0
Transconductance.....	4300	ma/ohm
Grid-No.1 Voltage (Approx.) for transconductance of 40 amhos.....	-20	volts
Plate Current.....	10.8	ma
Grid-No.2 Current.....	4.4	ma

INSTALLATION AND APPLICATION

Type 6BA6 requires miniature seven-contact socket and may be mounted in any position. Outline 7B, OUTLINES SECTION.

Control-grid bias variation will be found effective in changing the volume of the receiver. In order to obtain adequate volume control, an available grid-No.1-bias voltage of approximately 50 volts will be required. The exact value will depend upon the circuit design and operating conditions. This voltage may be obtained, depending on the receiver requirements, from a potentiometer across a fixed supply voltage, from a variable cathode-bias resistor, from the avc system, or from a combination of these methods.

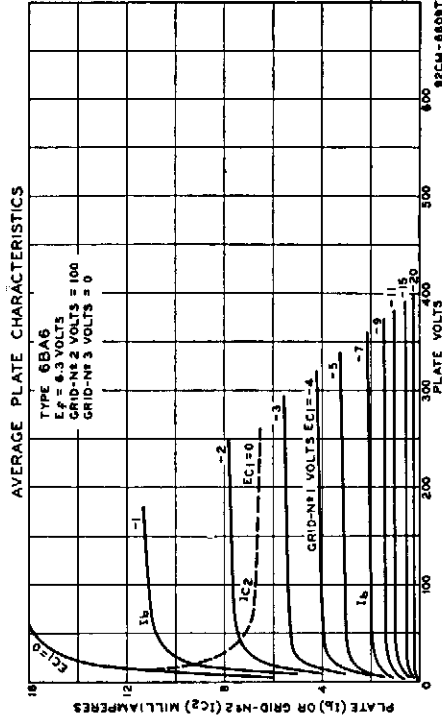

The grid-No. 2 (screen-grid) voltage may be obtained from a potentiometer or bleeder circuit across the B-supply source, or through a dropping resistor from the plate supply. The use of series resistors for obtaining satisfactory control of grid-No.2 voltage in the case of four-electrode tubes is usually impossible because of secondary-emission phenomena. In the 6BA6, however, because grid No.3 practically removes these effects, it is practical to obtain grid-No.2 voltage through a series-dropping resistor from the plate supply or from some high intermediate voltage, provided the source does not exceed the plate-supply voltage. With this method, the grid-No.2-to-cathode voltage will fall off very little from minimum to maximum value of the resistor controlling cathode bias. In some cases, it may actually rise. This rise of grid-No.2-to-cathode voltage above the normal maximum value is allowable because both the grid-No.2 current and the plate current are reduced simultaneously by a sufficient amount to prevent damage to the tube. It should be recognized that, in general, the series-resistor method of obtaining grid-No.2 voltage from a higher voltage supply necessitates the use of the variable cathode-resistor method of controlling volume in order to prevent too high a voltage on grid No.2. When grid-No.2 and control-grid voltage are obtained in this manner, the remote "cutoff" advantage of the 6BA6 can be fully realized. However, it should be noted that the use of a resistor in the grid-No.2 circuit will have an effect on the change in plate resistance with variation in grid-No.3 (suppressor-grid) voltage in case grid No.3 is utilized for control purposes.

Grid No.3 (suppressor grid) may be connected directly to the cathode or it may be made negative with respect to the cathode. For the latter condition, the grid-No.3 voltage may be obtained from a potentiometer or bleeder circuit, or from the avc system.

6BA7

Related type:
12BA7

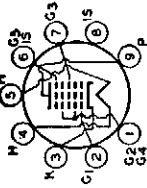

PENTAGRID CONVERTER
Miniature type used as converter in superheterodyne circuits especially those for the FM broadcast band. Outline 8D, OUTLINES SECTION. Tube requires miniature nine-contact socket and may be mounted in any position. Heater volts (ac/dc), 6.3, amperes, 0.3.

CONVERTER SERVICE

Maximum Ratings, (Design-Center Values):

PLATE VOLTAGE.....	300 max	volts
GRID-NO.5-AND-INTERNAL-SHIELD*.....	0 max	volts
GRIDS-NO.2-AND-NO.4 (SCREEN-GRID) VOLTAGE.....	100 max	volts
GRIDS-NO.2-AND-NO.4 SUPPLY VOLTAGE.....	300 max	watts
PLATE DISSIPATION.....	2.0 max	watts
GRIDS-NO.2-AND-NO.4 INPUT.....	1.5 max	ma
TOTAL CATHODE CURRENT.....	22 max	ma
GRID-NO.3 VOLTAGE.....	-100 max	volts
Negative bias value.....	0 max	volts
PEAK HEATER-CATHODE VOLTAGE.....	90 max	volts
Heater negative with respect to cathode.....	90 max	volts
Heater positive with respect to cathode.....		

Characteristics (Separate Excitation)**

Plate Voltage.....	100	volts
Grid No.5 and Internal Shield*.....	Connected directly to ground	
Grid-No.2-and-No.4 (Screen-Grid) Voltage.....	100	volt
Grid-No.3 (Control-Grid) Voltage.....	-1.0	volt
Grid-No.1 (Oscillator-Grid) Resistor.....	20000	ohms
Plate Resistance (Approx.).....	900	megohms
Conversion Transconductance.....	3.6	amhos
Conversion Transconductance (Approx.)**.....	3.3	amhos
Plate Current.....	3.6	ma
Grids-No.2-and-No.4 Current.....	10.2	ma
Grid-No.1 Current.....	0.35	ma
Total Cathode Current.....	14.2	ma

NOTE: The transconductance between grid No.1 and grids No.2 and No.4 connected to plate (not oscillating) is approximately 8000 amhos under the following conditions: signal applied to grid No.1 at zero bias; grids No.2 and No.4 and plate at 100 volts; grid No.3 grounded. Under the same conditions, the plate current is 82 milliamperes, and the amplification factor is 16.5.

* The characteristics shown with separate excitation correspond very closely with those obtained in a self-excited oscillator circuit operating with zero bias.
** With grid-No.3 bias of -20 volts.
* Internal Shield (pins No.6 and No.8) connected directly to ground.

MEDIUM-MU TRIODE — SHARP-CUTOFF PENTODE

Miniature type used in a wide variety of applications in color and black-and-white television receivers. This type has a controlled heater warm-up time for use in receivers employing series-connected heater strings. The pentode unit is used as a video amplifier, an agc amplifier, or a reactance tube. The triode unit is used in low-frequency oscillator and phase-splitter circuits. Outline 8D, OUTLINES SECTION. Tube requires miniature nine-contact socket and may be mounted in any position.

6BA8A

Related type:
8BA8A

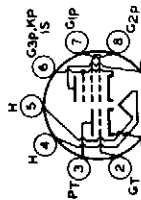

HEATER VOLTAGE (AC/DC).....	6.3	volts
HEATER CURRENT.....	0.6	ampere
HEATER WARM-UP TIME (Average).....	11	seconds
	With External Shield*	
Without External Shield**.....	2.2	
Grid to Cathode.....	2.5	pf
Grid to Cathode and Heater.....	2.3	pf
Plate to Cathode and Heater.....	0.4	pf

DIRECT INTERELECTRODE CAPACITANCES (Approx.):

Triode Unit:		
Grid to Plate.....	2.2	pf
Grid to Cathode.....	2.3	pf
Plate to Cathode and Heater.....	0.4	pf

Pentode Unit:

Grid No.1 to Plate.....	0.06	0.05	pf
Grid No.1 to Cathode, Heater, Grid No.2, Grid No.3, and Internal Shield.....	10	10	pf
Plate to Cathode, Heater, Grid No.2, Grid No.3, and Internal Shield.....	3.6	4.5	pf
Triode Grid to Pentode Plate.....	0.016	0.006	pf
Pentode Grid No.1 to Triode Plate.....	0.006	0.003	pf
Pentode Plate to Triode Plate.....	0.15	0.023	pf

* With external shield connected to cathode of unit under test.

CLASS A₁ AMPLIFIER

Maximum Ratings, (Design-Center Values):

PLATE VOLTAGE.....	300 max	volts
GRID-NO.2 (SCREEN-GRID) SUPPLY VOLTAGE.....	300 max	volts
GRID-NO.2 VOLTAGE.....	See curve page 70	
GRID-NO.1 (CONTROL-GRID) VOLTAGE.....		
Negative bias value.....	-50 max	volts
Positive bias value.....	3.25 max	volts
PLATE DISSIPATION.....	2 max	watts
GRID-NO.2 INPUT.....		
For grid-No.2 voltages up to 150 volts.....	1 max	watt
For grid-No.2 voltages between 150 and 300 volts.....	See curve page 70	
PEAK HEATER-CATHODE VOLTAGE.....	200 max	volts
Heater negative with respect to cathode.....	200 max	volts
Heater positive with respect to cathode.....	200 max	volts

Characteristics

Plate-Supply Voltage.....	200	volts
Grid-No.2 Supply Voltage.....	150	volts
Grid-No.1 Voltage.....	-8	volts
Cathode-Bias Resistor.....	180	ohms
Amplification Factor.....	18	
Plate Resistance (Approx.).....	6700	ohms
Transconductance.....	2700	amhos
Grid-No.1 Voltage (Approx.) for plate current of 10 μ a.....	-16	volts
Plate Current.....	8	ma
Grid-No.2 Current.....	3.5	ma

Maximum Circuit Values

Grid-No.1-Circuit Resistance.....	0.5 max	megohm
For fixed-bias operation.....	1.0 max	megohm
For cathode-bias operation.....		
* The dc component must not exceed 100 volts.		

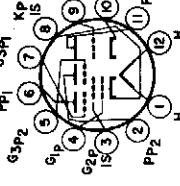

TRIODE — TWIN PENTODE

Duodec type used as vertical deflection oscillator and for combined sync-age applications in television receivers employing series-connected heater strings. Outline 12B, OUTLINES SECTION. Tube requires duodec twelve-contact socket and may be mounted in any position. Heater volts (ac/dc), 6.3; amperes, 0.6; warm-up time (average), 11 seconds. For ratings and characteristics of pentode units, refer to type 6HS8.

TRIODE UNIT AS CLASS A₁ AMPLIFIER

Maximum Ratings, (Design-Center Values):

PLATE VOLTAGE.....	300 max	volts
AVERAGE CATHODE CURRENT.....	20 max	ma
PLATE DISSIPATION.....	1.5 max	watts
HEATER-CATHODE VOLTAGE.....		
Heater negative with respect to cathode.....	200 max	volts
Heater positive with respect to cathode.....	200 max	volts
Characteristics:		
Plate Voltage.....	250	volts
Grid Voltage.....	-1	volts
Amplification Factor.....	18	
Transconductance.....	1800	amhos
Plate Current.....	8	ma
Grid Voltage (Approx.) for plate current of 100 μ a.....	-18	volts

Maximum Circuit Values:

Grid-Circuit Resistance.....	0.25 max	megohm
For fixed-bias operation.....	1 max	megohm
For cathode-bias operation.....		
* The dc component must not exceed 100 volts.		

MEDIUM-MU TRIODE

Miniature type used as an rf amplifier in the cathode-drive circuits of uhf television tuners covering the frequency range of 470 to 890 megacycles per second. Outline 8A, OUTLINES SECTION. Tube requires miniature nine-contact socket and may be mounted in any position.

6BC4

Related types: 3BC3, 4BC3

HEATER VOLTAGE (AC/DC)	6.3 volts
HEATER CURRENT	0.225 ampere
DIRECT INTERELECTRODE CAPACITANCES (Approx.):	
Grid to Plate	1.6 pf
Grid to Heater and Cathode	2.9 pf
Plate to Heater and Cathode	0.26 pf
Heater to Cathode	2.7 pf

CLASS A₁ AMPLIFIER

Maximum Ratings, (Design-Center Values):

PLATE VOLTAGE	250 max	volts
PLATE CURRENT	2.5 max	ma
CATHODE CURRENT	25 max	ma
PEAK HEATER-CATHODE VOLTAGE:		
Heater negative with respect to cathode	75 max	volts
Heater positive with respect to cathode	75 max	volts
Characteristics:		
Plate Supply Voltage	150	volts
Cathode-Bias Resistor	100	ohms
Amplification Factor	48	
Plate Resistance (Approx.)	4800	ohms
Transconductance	10000	μmhos
Grid Voltage (Approx.) for plate current of 10 μa	-10	volts
Plate Current	14.5	ma

Maximum Circuit Values:

Grid-Circuit Resistance:	Not recommended
For fixed-bias operation	0.5 max
For cathode-bias operation	megohm

SHARP-CUTOFF PENTODE

Miniature type used in compact radio equipment as an rf or if amplifier at frequencies up to 400 megacycles per second. Outline 7B, OUTLINES SECTION. Tube requires miniature nine-contact socket and may be mounted in any position. For typical operation as resistance-coupled amplifier, refer to RESISTANCE-COUPLED AMPLIFIER SECTION.

6BC5

Related types: 3BC3, 4BC3

HEATER VOLTS (AC/DC)	6.3	volts
HEATER CURRENT	0.3	ampere
DIRECT INTERELECTRODE CAPACITANCES:		
Pentode Connection:		
Grid No.1 to Plate	0.090 max	pf
Grid No.1 to Cathode, Heater, Grid No.3, and Internal Shield	6.5	pf
Plate to Cathode, Heater, Grid No.2, Grid No.3, and Internal Shield	1.8	pf
Triode Connection:*		
Grid No.1 to Plate and Grid No.2	2.5	pf
Grid No.1 to Cathode, Heater, Grid No.3, and Internal Shield	3.9	pf
Plate and Grid No.2 to Cathode, Heater, Grid No.3, and Internal Shield	3.0	pf

* Grid No.2 connected to plate.

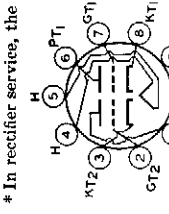
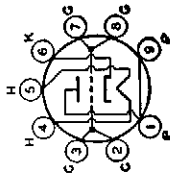

CLASS A₁ AMPLIFIER
Maximum Ratings, (Design-Center Values):

PLATE VOLTAGE	300 max	Pentode Connection	300 max
GRID-NO.2 SUPPLY VOLTAGE	300 max	Triode Connection*	300 max
GRID-NO.1 (CONTROL-GRID) VOLTAGE, Positive-bias value	0 max		
PLATE DISSIPATION	2 max		
GRID-NO.2 INPUT:			
For grid-No.2 voltages up to 150 volts	0.5 max		
For grid-No.2 voltages between 150 and 300 volts	See curve page 70		
PEAK HEATER-CATHODE VOLTAGE:			
Heater negative with respect to cathode	90 max		
Heater positive with respect to cathode	90 max		

Characteristics:

Plate Supply Voltage	180	250	100	125	250	volts
Grid-No.2 Supply Voltage	390	820	180	100	150	volts
Cathode-Bias Resistor	42	40	—	—	—	ohms
Amplification Factor	0.005	0.009	0.6	0.5	0.8	megohm
Plate Resistance (Approx.)	6000	4400	4900	6100	5700	μmhos
Transconductance	—	—	—	—	—	volts
Grid-No.1 Voltage (Approx.) for plate current of 10 μa	8	6	4.7	8	7.5	ma
Plate Current	—	—	1.4	2.4	2.1	ma

* Grid No.2 connected to plate.

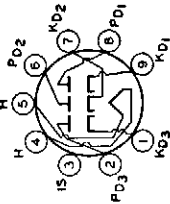

TRIPLE DIODE

Miniature type containing three high-perveance diode units in one envelope; used in dc restorer circuits of color television receivers. Also used in AM/FM radio receivers as a combination FM discriminator and AM detector tube. Outline 8B, OUTLINES SECTION. Tube requires nine-contact miniature socket and may be mounted in any position.

6BC7

HEATER VOLTAGE (AC/DC)	5.3	volts
HEATER CURRENT	0.450	ampere
DIRECT INTERELECTRODE CAPACITANCES (Approx.):		
Diode-No.1 Plate to Diode-No.2 Cathode, Heater, and Internal Shield	3.5	pf
Diode-No.2 Plate to Diode-No.3 Cathode, Heater, and Internal Shield	3.5	pf
Diode-No.3 Plate to Diode-No.3 Cathode, Heater, and Internal Shield	3.5	pf

Maximum Ratings, (Design-Center Values, Each Diode Unit):

PEAK INVERSE PLATE VOLTAGE	330 max	volts
PEAK PLATE CURRENT	54 max	ma
DC OUTPUT CURRENT	12 max	ma
PEAK HEATER-CATHODE VOLTAGE:		
Heater negative with respect to cathode	200 max	volts
Heater positive with respect to cathode	200 max	volts

* In rectifier service, the minimum total effective plate-supply impedance per plate is 560 ohms.

MEDIUM-MU TWIN TRIODE

Miniature type used in direct-coupled cathode-drive rf amplifier circuits of vhf television tuners. In such circuits, one triode unit is used as the direct-coupled grounded-cathode driver for the other unit. This type is also used in push-pull cathode-drive rf amplifiers. Outline 8B, OUTLINES SECTION. Tube requires miniature nine-contact socket and may be mounted in any position.

6BC8

Related types: 4BC8

HEATER VOLTAGE (AC/DC)	6.3	volts
HEATER CURRENT	0.4	ampere
DIRECT INTERELECTRODE CAPACITANCES:		
Grid to Plate	1.2	Unit No.1
Grid to Cathode, Heater, and Internal Shield	2.6	Unit No.2
Cathode to Grid, Heater, and Internal Shield	5.5	—
Plate to Cathode, Heater, and Internal Shield	1.3	—
Plate to Grid, Heater, and Internal Shield	2.4	—
Plate to Cathode	0.12	—
Heater to Cathode	2.8	—
Plate of Unit No.1 to Plate of Unit No.2	0.02 max	—
Plate of Unit No.2 to Plate and Grid of Unit No.1	0.04 max	—

* With external shield connected to internal shield.

CLASS A₁ AMPLIFIER (Each Unit)

Maximum Ratings, (Design-Maximum Values):	
PLATE VOLTAGE.....	250* <i>max</i> volts
PLATE DISSIPATION.....	2.2 <i>max</i> watts
CATHODE CURRENT.....	22 <i>max</i> ma
PEAK HEATER-CATHODE VOLTAGE:	
Heater negative with respect to cathode.....	200* <i>max</i> volts
Heater positive with respect to cathode.....	200* <i>max</i> volts
Characteristics:	
Plate Supply Voltage.....	150 volts
Cathode-Bias Resistor.....	220 ohms
Plate Resistance (Approx.).....	5800 ohms
Amplification Factor.....	35
Transconductance.....	6200 μ hos
Grid Voltage (Approx.) for transconductance of 50 μ hos.....	-13 volts
Plate Current.....	10 ma
Maximum Circuit Values:	
Grid-Circuit Resistance.....	0.5 <i>max</i> megohm
* This rating may be as high as 300 volts under cutoff conditions, when the tube is used as a cascade amplifier and the two units are connected in series.	
† The dc component must not exceed 100 volts.	

SHARP-CUTOFF BEAM TRIODE

Glass octal types used for the voltage regulation of high-voltage, low-current dc power supplies in color-television receivers. Outline 25B, OUTLINES SECTION. Tubes require octal socket. Heater volts (ac/dc), 6.3; amperes, 0.6. Maximum ratings for voltage-control service: dc plate volts, 6BD4 29000 *max*, 6BD4-A 27000 *max*; unregulated dc supply volts, 6BD4 40000 *max*, 6BD4-A 55000 *max*; dc grid volts, -125 *max*; peak grid volts, -550 *max*; dc plate ma, 1.5 *max*; plate dissipation, 6BD4 20 *max* watts, 6BD4-A 25 *max* watts; peak heater-cathode volts, 180 *max*. These are DISCONTINUED types listed for reference only.

6BD4

6BD4A

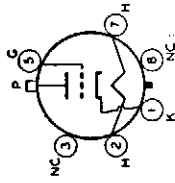

REMOTE-CUTOFF PENTODE

Miniature type used as rf or if amplifier in radio receivers. This type is similar in performance to metal type 6SK7. Outline 7B, OUTLINES SECTION. Tube requires miniature seven-contact socket and may be mounted in any position. Heater volts (ac/dc), 6.3; amperes, 0.3. Characteristics as class A₁ amplifier: plate volts, 250 (300 *max*); grid No.3 connected to cathode at socket; grid-No.2 volts, 100 (125 *max*); grid-No.1 volts, -3; plate resistance (approx.), 0.8 megohm; transconductance, 2000 μ hos; plate dissipation, 3 *max* watts; grid-No.2 input, 0.65 *max* watt; plate ma., 9; grid-No.2 ma., 3; total cathode ma., 14 *max*; peak heater-cathode volts, 90 *max*. This type is used principally for renewal purposes.

6BD6

Related type: 12BD6

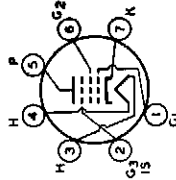

HALF-WAVE VACUUM RECTIFIER

Duodecar type used as damper tube in horizontal-deflection circuits of television receivers. Outline 12D, OUTLINES SECTION. Tube requires duodecar twelve-contact socket and may be mounted in any position. Heater volts (ac/dc), 6.3; amperes, 1.2.

6BE3

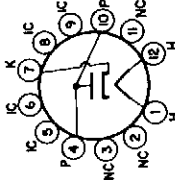

DAMPER SERVICE

For operation in a 525-line, 30-frame system

Maximum Ratings, (Design-Maximum Values):	
PEAK INVERSE PLATE VOLTAGE.....	5000 <i>max</i> volts
PEAK PLATE CURRENT.....	1200 <i>max</i> ma
DC PLATE CURRENT.....	200 <i>max</i> ma
PLATE DISSIPATION.....	6.5 <i>max</i> watts

PEAK HEATER-CATHODE VOLTAGE:
Heater negative with respect to cathode.....
Heater positive with respect to cathode.....

5000**max* volts
300**max* volts

Characteristics, Instantaneous Value:

Tube Voltage Drop for dc plate current of 350 ma..... 25 volts

The duration of the voltage pulse must not exceed 15 per cent of one horizontal scanning cycle. In a 525-line, 30-frame system, 15 per cent of one horizontal scanning cycle is 10 microseconds.

- † The dc component must not exceed 900 volts.
- ‡ The dc component must not exceed 100 volts.

PENTAGRID CONVERTER

Miniature type used as converter in superheterodyne circuits in both the standard broadcast and FM bands. The 6BE6 is similar in performance to metal type 6SA7. For general discussion of pentagrid types, see Frequency Conversion in ELECTRON TUBE APPLICATION SECTION.

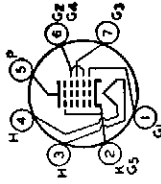

6BE6

Related types: 3BE6, 12BE6

HEATER VOLTAGE (AC/DC)..... 6.3 volts
HEATER CURRENT..... 0.3 ampere

DIRECT INTERELECTRODE CAPACITANCES:

Grid No.3 to Plate.....	Without Shield	0.80 <i>max</i>	pf
Grid No.3 to Grid No.1.....	With External Shield	0.15 <i>max</i>	pf
Grid No.6 to Plate.....	Without Shield	0.15 <i>max</i>	pf
Grid No.3 to All Other Electrodes.....	With External Shield	0.05 <i>max</i>	pf
Grid No.1 to All Other Electrodes.....	Without Shield	7.0	pf
Plate to All Other Electrodes.....	Without Shield	5.5	pf
Grid No.1 to Cathode and Grid No.5.....	Without Shield	8.0	pf
Cathode and Grid No.5 to All Other Electrodes except Grid No.1.....	Without Shield	3.0	pf
Grid No.1.....	Without Shield	15.0	pf

- With external shield connected to cathode and grid No.5.

CONVERTER

Maximum Ratings, (Design-Maximum Values):

PLATE VOLTAGE.....	330 <i>max</i> volts
GRIDS-No.2-AND-No.4 (SCREEN-GRID) VOLTAGE.....	110 <i>max</i> volts
GRIDS-No.2-AND-No.4 SUPPLY VOLTAGE.....	330 <i>max</i> volts
PLATE DISSIPATION.....	1.1 <i>max</i> watts
GRIDS-No.2-AND-No.4 INPUT CATHODE CURRENT.....	1.1 <i>max</i> watts
GRID-No.3 VOLTAGE.....	15.5 <i>max</i> ma
Negative bias value.....	-65 <i>max</i> volts
PEAK HEATER-CATHODE VOLTAGE:	
Heater negative with respect to cathode.....	0 <i>max</i> volts
Heater positive with respect to cathode.....	200 <i>max</i> volts

Typical Operation (Separate Excitation)*

Plate Voltage.....	100 volts
GRIDS-No.2-and-No.4 (Screen-Grid) Voltage.....	100 volts
Grid-No.1 (Oscillator-Grid) Voltage (rms).....	10 volts
Grid-No.3 (Control-Grid) Voltage.....	-1.5 volts
Grid-No.1 (Oscillator-Grid) Resistor.....	20000 ohms
Plate Resistance (Approx.).....	0.4 megohm
Conversion Transconductance.....	455 μ hos
Grid-No.3 Voltage for conversion transconductance of 10 μ hos.....	-30 volts
Plate Current.....	2.5 ma
GRIDS-No.2-and-No.4 Current.....	7.0 ma
Grid-No.1 Current.....	0.5 ma
Cathode Current.....	10.1 ma

Note: The transconductance between grid No.1 and grids No.2 and No.4 connected to plate (not oscillating) is approximately 7250 μ hos under the following conditions: grids No.1 and No.3 at 0 volts; grids No.2 and No.4 at 100 volts. Under the same conditions, the cathode current is 25 ma., and the amplification factor is 20. Grid-No.1 voltage (Approx.) for plate current of 10 μ a is -11 volts.

- * The dc component must not exceed 100 volts.
- † The characteristics shown with separate excitation correspond very closely with those obtained in a self-excited oscillator circuit operating with zero bias.

INSTALLATION AND APPLICATION

Type 6BE6 requires miniature seven-contact socket and may be mounted in any position. Outline 7B, OUTLINES SECTION.

Because of the special structural arrangement of the 6BE6, a change in signal-

grid voltage produces little change in cathode current. Consequently, an rf voltage on the signal grid produces little modulation of the electron current flowing in the cathode circuit. This feature is important because it is desirable that the impedance in the cathode circuit should produce little degeneration or regeneration of the signal-frequency input and intermediate-frequency output. Another important feature is that, because signal-grid voltage has very little effect on the space charge near the cathode, changes in avc bias produce little change in oscillator transconductance and in the input capacitance of grid No.1. There is, therefore, little detuning of the oscillator by avc bias.

A typical self-excited oscillator circuit employing the 6BE6 is given in the CIRCUIT SECTION.

In the 6BE6 operation characteristics curves with self-excitation, E_s is the voltage across the oscillator-coil section between cathode and ground; E_k is the oscillator voltage between cathode and grid.

OPERATION CHARACTERISTICS WITH SELF-EXCITATION

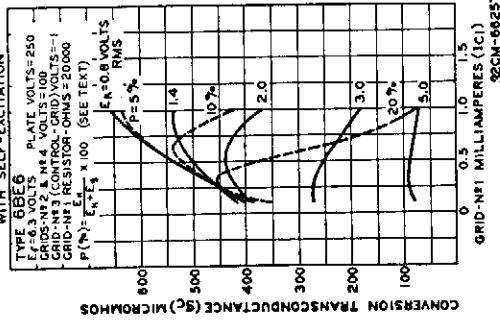

OPERATION CHARACTERISTICS WITH SEPARATE OSCILLATOR EXCITATION

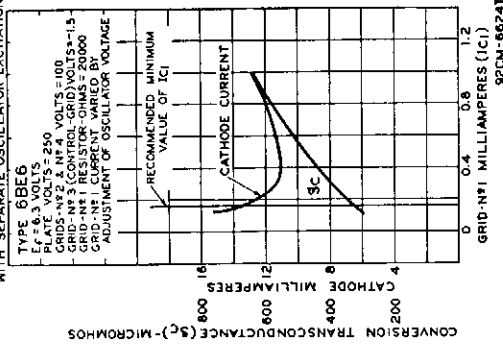

BEAM POWER TUBE

Miniature type used in audio output stage of television and radio receivers. Triode-connected, it is used as a vertical deflection amplifier in television receivers. Outline 7C, OUTLINES SECTION. Tube requires miniature seven-contact socket and may be mounted in any position. Heater volts (ac/dc), 6.3; ampere, 1.2. Typical operation as class A₁ amplifier: plate volts, 110 (250 max); grid-No.2 volts, 110 (117 max); grid-No.1 volts, -7.5; plate dissipation, 5.5 max watts; grid-No.2 input, 1.25 max watts; plate ma., 36 (zero-signal), 39 (maximum-signal); grid-No.2 ma., 4 (zero-signal), 10.5 (maximum-signal); plate resistance (approx.), 12000 ohms; transconductance, 1500 amhos; plate load resistance, 2500 ohms; total harmonic distortion, 10 per cent; maximum-signal power output, 1.9 watts; peak heater-cathode volts, 200 max (dc component 100 max when heater is positive with respect to cathode). This type is used principally for renewal purposes.

6BF5

Related type: 12BF5

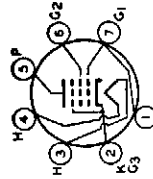

TWIN DIODE—MEDIUM-MU TRIODE

Miniature type used in compact radio equipment as combined detector, amplifier, and avc tube. The triode unit is particularly useful as a driver for impedance- or transformer-coupled

6BF6

Related type: 12BF6

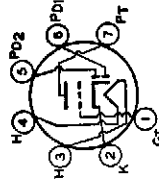

output stages in automobile receivers. It is equivalent in performance to metal type 6SR7. Outline 7B, OUTLINES SECTION. Tube requires miniature seven-contact socket and may be mounted in any position.

HEATER VOLTAGE (AC/DC)	6.3	volts
HEATER CURRENT	0.3	ampere
DIRECT INTERELECTRODE CAPACITANCES:		
Triode Grid to Triode Plate	1.9	pf
Triode Grid to Cathode and Heater	1.9	pf
Triode Plate to Cathode and Heater	1.2	pf
Plate of Diode Unit No.1 to Triode Grid	0.06	max maz
Plate of Diode Unit No.2 to Triode Grid	0.05	max maz

■ With external shield connected to cathode.

TRIODE UNIT AS CLASS A₁ AMPLIFIER

Maximum Ratings, (Design-Center Values):		
PLATE VOLTAGE	300 max	volts
PLATE DISSIPATION	2.5 max	watts
PEAK HEATER-CATHODE VOLTAGE:		
Heater negative with respect to cathode	90 max	volts
Heater positive with respect to cathode	90 max	volts
Typical Operation:		
Plate Voltage	250	volts
Grid Voltage	-9	volts
Amplification Factor	16	
Plate Resistance (Approx.)	8500	ohms
Transconductance	1800	amhos
Plate Current	9.5	ma
Load Resistance	10000	ohms
Total Harmonic Distortion	6.5	per cent
Power Output	800	mW

DIODE UNITS

Maximum Rating:		
PLATE CURRENT (Each Unit)	1.0 max	ma
The two diode plates and the triode unit have a common cathode. Diode biasing of the triode unit of the 6BF6 is not suitable. For diode operation curves, refer to type 6AV6.		

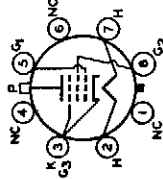

BEAM POWER TUBE

Glass octal types used as output amplifier in horizontal-deflection circuits of television equipment and other applications where high pulse voltages occur during short duty cycles. Type 6BG6-GA, Outline 25A, OUTLINES SECTION. Type 6BG6-G maximum dimensions: over-all length, 5-11/16 inches; seated height, 5-1/8 inches; diameter, 2-1/16 inches. Tubes require octal socket. They may be supplied with pins 4 and 6 with pins 1, 4, and 6 omitted. Vertical tube mounting is preferred but horizontal operation is permissible if pins No.2 and 7 are in vertical plane. Type 6BG6-G is used principally for renewal purposes.

6BG6G
6BG6GA

Related type: 198G6GA

HEATER VOLTAGE (AC/DC)	6.3	volts
HEATER CURRENT	0.9	ampere
DIRECT INTERELECTRODE CAPACITANCES:		
Grid No.1 to Plate	0.84	pf
Grid No.1 to Cathode, Heater, Grid No.2, and Grid No.3	11	pf
Plate to Cathode, Heater, Grid No.2, and Grid No.3	6	pf
TRANSCONDUCTANCE	6000	amhos
MU-FACTOR, Grid No.2 to Grid No.1*	8.0	

*For plate and grid-No.2 volts, 250; grid-No.1 volts, -15.

HORIZONTAL DEFLECTION AMPLIFIER

For operation in a 525-line, 50-frame system

Maximum Ratings, (Design-Center Values):		
DC PLATE VOLTAGE	700 max	volts
PEAK POSITIVE-PULSE PLATE VOLTAGE* (Absolute Maximum)	6600*	max
PEAK NEGATIVE-PULSE PLATE VOLTAGE	-1500	max
DC GRID-No.2 (SCREEN-GRID) VOLTAGE	350	max
PEAK NEGATIVE-PULSE GRID-No.1 (CONTROL-GRID) VOLTAGE	-300	max
PEAK CATHODE CURRENT	400	ma
AVERAGE CATHODE CURRENT	110	max
PLATE DISSIPATION†	20	watts
GRID-No.2 INPUT	3.2	max

PEAK HEATER-CATHODE VOLTAGE:

Heater negative with respect to cathode..... volts
 Heater positive with respect to cathode..... volts
BULB TEMPERATURE (At hottest point):..... °C

Maximum Circuit Value:

Grid-No.1-Circuit Resistance..... 0.47 *meas* megohm
 * The duration of the voltage pulse must not exceed 15 per cent of one horizontal scanning cycle. In a 525-line, 30-frame system, 15 per cent of one horizontal scanning cycle is 10 microseconds.
 † Under no circumstances should this absolute value be exceeded.
 ‡ An adequate bias resistor or other means is required to protect the tube in the absence of excitation.
 § The dc component must not exceed 100 volts.

HALF-WAVE VACUUM RECTIFIER

Novar type used as damper tube in horizontal deflection circuits of black-and-white television receivers. Outline 17A, OUTLINES SECTION. Tube requires novar socket and may be operated in any position. Socket terminals 1, 3, 6, and 8 should not be used as tie points. It is especially important that this tube, like other power-handling tubes, be adequately ventilated.

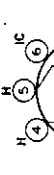

HEATER VOLTAGE (AC/DC):..... 6.3 volts
HEATER CURRENT:..... 1.6 amperes
DIRECT INTERELECTRODE CAPACITANCES (Approx.):
 Plate to Cathode and Heater..... pf
 Cathode to Plate and Heater..... pf
 Heater to Cathode..... pf

DAMPER SERVICE

For operation in a 525-line, 30-frame system

Maximum Ratings, (Design-Maximum Values):
PEAK INVERSE PLATE VOLTAGE..... 5500 *meas* volts
PEAK PLATE CURRENT..... 1100 *meas* ma
DC PLATE CURRENT..... 180 *meas* ma
PLATE DISSIPATION..... 6.5 *meas* watts
PEAK HEATER-CATHODE VOLTAGE:
 Heater negative with respect to cathode..... 5500 *meas* volts
 Heater positive with respect to cathode..... 300-7 *meas* volts
 † The duration of the voltage pulse must not exceed 15 per cent of one horizontal scanning cycle. In a 525-line, 30-frame system, 15 per cent of one horizontal scanning cycle is 10 microseconds.
 * The dc component must not exceed 900 volts.
 ‡ The dc component must not exceed 100 volts.



6BH6

SHARP-CUTOFF PENTODE

Miniature type used as rf amplifier particularly in ac/dc receivers and in mobile equipment where low heater-current drain is important. It is particularly useful in high-frequency, wide-band applications. Outline 7B, OUTLINES SECTION. Tube requires miniature seven-contact socket and may be mounted in any position.

HEATER VOLTAGE (AC/DC):..... 6.3 volts
HEATER CURRENT:..... 0.15 ampere
DIRECT INTERELECTRODE CAPACITANCES:
 Grid No.1 to Plate, Heater, Grid No.3, and Internal Shield..... 0.0035 *meas* pf
 Grid No.1 to Cathode, Heater, Grid No.2, Grid No.3, and Internal Shield..... 5.4 pf
 Plate to Cathode, Heater, Grid No.2, Grid No.3, and Internal Shield..... 4.4 pf
 * Without external shield, or with external shield connected to cathode.

CLASS A₁ AMPLIFIER

Maximum Ratings, (Design-Center Values):
PLATE VOLTAGE:..... 300 *meas* volts
GRID-NO.2 (SCREEN-GRID) VOLTAGE:..... See curve page 70
GRID-NO.2 SUPPLY VOLTAGE:..... 300 *meas* volts
PLATE DISSIPATION:..... 3 *meas* watts
GRID-NO.2 INPUT:
 For grid-No.2 voltages up to 150 volts..... 0.5 *meas* watt
 For grid-No.2 voltages between 150 and 300 volts..... See curve page 70
GRID-NO.1 (CONTROL-GRID) VOLTAGE:..... -50 *meas* volts
Positive-bias value:..... 0 *meas* volts
Negative-bias value:.....

PEAK HEATER-CATHODE VOLTAGE:

Heater negative with respect to cathode..... 90 *meas* volts
 Heater positive with respect to cathode..... 90 *meas* volts

Characteristics:

Plate Voltage..... 250 volts
 Grid No.3 and Internal Shield..... Connected to cathode at socket
 Grid-No.2 Voltage..... 100 volts
 Grid-No.1 Voltage..... 150 volts
 Plate Resistance (Approx.)..... 0.7 megohms
 Transconductance..... 3400 μ mbos
 Grid-No.1 Voltage (Approx.) for plate current of 10 μ a..... -7.7 volts
 Plate Current..... 3.6 ma
 Grid-No.2 Current..... 1.4 ma

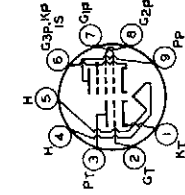

MEDIUM-MU TRIODE—SHARP-CUTOFF PENTODE

Miniature type used in a wide variety of applications in television receivers. This type has a controlled heater warm-up time for use in receivers employing series-connected heater strings. The pentode unit is used as an amplifier, a video amplifier, or an age amplifier. The triode unit is used in low-frequency oscillator circuits. Outline 8D, OUTLINES SECTION. Tube requires miniature nine-contact socket and may be mounted in any position.

6BH8

Related type: 8BH8

HEATER VOLTAGE (AC/DC):..... 6.3 volts
HEATER CURRENT:..... 0.6 ampere
HEATER WARM-UP TIME (Average):..... 11 seconds
DIRECT INTERELECTRODE CAPACITANCES (Approx.):
 Triode Unit:
 Grid to Plate..... 2.4 pf
 Grid to Cathode and Heater..... 2.6 pf
 Plate to Cathode and Heater..... 0.38 pf
 Pentode Unit:
 Grid No.1 to Plate..... 0.046 pf
 Grid No.1 to Cathode, Heater, Grid No.2, Grid No.3, and Internal Shield..... 7 pf
 Plate to Cathode, Heater, Grid No.2, Grid No.3, and Internal Shield..... 2.4 pf
 Triode Grid to Pentode Plate..... 0.016 pf
 Pentode Grid No.1 to Triode Plate..... 0.004 pf
 Pentode Plate to Triode Plate..... 0.095 pf

CLASS A₁ AMPLIFIER

Maximum Ratings, (Design-Center Values):
PLATE VOLTAGE:..... 300 *meas* volts
GRID-NO.2 (SCREEN-GRID) SUPPLY VOLTAGE:..... 300 *meas* volts
GRID-NO.2 VOLTAGE:..... See curve page 70
GRID-NO.1 (CONTROL-GRID) VOLTAGE, Positive-bias value:..... 0 *meas* volts
PLATE DISSIPATION:..... 3 *meas* watts
GRID-NO.2 INPUT:
 For grid-No.2 voltages up to 150 volts..... 1 *meas* watt
 For grid-No.2 voltages between 150 and 300 volts..... See curve page 70
PEAK HEATER-CATHODE VOLTAGE:
 Heater negative with respect to cathode..... 200 *meas* volts
 Heater positive with respect to cathode..... 200 *meas* volts

Characteristics:
 Plate Supply Voltage..... 150 volts
 Grid-No.2 Supply Voltage..... 125 volts
 Grid-No.1 Voltage..... -5 volts
 Cathode-Bias Resistor..... -82 ohms
 Amplification Factor..... 17
 Plate Resistance (Approx.)..... 5150 ohms
 Transconductance..... 7000 μ mbos
 Grid-No.1 Voltage (Approx.) for plate current of 100 μ a..... -14 volts
 Plate Current..... 9.5 ma
 Grid-No.2 Current..... 3.4 ma

Maximum Circuit Values:
 Grid-No.1-Circuit Resistance: For fixed-bias operation..... 0.5 *meas* megohm
 For cathode-bias operation..... 1.0 *meas* megohm
 * The dc component must not exceed 100 volts.

REMOTE-CUTOFF PENTODE

Miniature type used as rf amplifier in high-frequency and wide-band applications. Features high transconductance and low grid-to-plate capacitance. Outline 7B, OUTLINES SECTION.

Tube requires miniature seven-contact socket and may be mounted in any position.

6BJ6

HEATER VOLTAGE (AC/DC).....	6.3	volts
HEATER CURRENT.....	0.15	ampere
DIRECT INTERELECTRODE CAPACITANCES:■		
Grid No.1 to Plate.....	0.0035 max	pf
Grid No.1 to Cathode, Heater, Grid No. 2, Grid No. 3, and Internal Shield.....	4.5	pf
Plate to Cathode, Heater, Grid No. 2, Grid No. 3, and Internal Shield.....	5.5	pf

■ Without external shield, or with external shield connected to cathode.

CLASS A₁ AMPLIFIER

Maximum Ratings, (Design-Center Values):

PLATE VOLTAGE.....	300 maz	volts
GRID-NO.2 (SCREEN-GRID) VOLTAGE.....	See curve page 70	volts
GRID-NO.2 SUPPLY VOLTAGE.....	300 maz	volts
PLATE DISSIPATION.....	3 maz	watts
GRID-NO.2 INPUT:		
For grid-No.2 voltages up to 150 volts.....	0.6 maz	watt
For grid-No.2 voltages between 150 and 300 volts.....	See curve page 70	volts
GRID-NO.1 (CONTROL-GRID) VOLTAGE:		
Negative bias value.....	-50 maz	volts
Positive bias value.....	0 maz	volts
PEAK HEATER-CATHODE VOLTAGE:		
Heater negative with respect to cathode.....	90 maz	volts
Heater positive with respect to cathode.....	90 maz	volts

Characteristics:

Plate Voltage.....	100	volts
Grid No.3.....	Connected to cathode at socket	
Grid-No.2 Voltage.....	100	volts
Grid-No.1 Voltage.....	-1.0	volt
Plate Resistance (Approx.).....	0.25	megohms
Transconductance.....	3650	μmhos
Grid-No.1 Voltage (Approx.) for transconductance of 10 μmhos.....	-20	volts
Plate Current.....	9.0	ma
Grid-No.2 Current.....	3.5	ma

TRIPLE DIODE

Miniature type used as a dc-restorer tube in each of the three signal channels of color-television receivers. Each diode has a separate cathode. Outline 8B, OUTLINES SECTION.

Tube requires miniature nine-contact socket and may be mounted in any position. Heater volts, 6.3; amperes, 0.45.

6BJ7

DC RESTORER SERVICE

Maximum Ratings, (Design-Center Values, Each Diode Unit):

PEAK INVERSE PLATE VOLTAGE.....	330 maz	volts
PEAK PLATE CURRENT.....	10 maz	ma
DC OUTPUT CURRENT.....	1 maz	ma
PEAK HEATER-CATHODE VOLTAGE:		
Heater negative with respect to cathode.....	330 maz	volts
Heater positive with respect to cathode.....	160 maz	volts

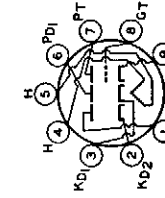

TWIN DIODE—MEDIUM-MU TRIODE

Miniature type used in a wide variety of applications in black-and-white and color television receivers.

The diode units are used in phase-detector, phase-comparator, ratio-de-

tor or discriminator, and horizontal afc discriminator circuits. The triode unit is used in phase-splitter, audio-frequency amplifier, and low-frequency oscillator applications; it may also be used as a vertical-deflection amplifier in compact portable television receivers. This type has a controlled heater warm-up time for use in receivers employing series-connected heater strings. Each of the three units has its own cathode with individual base-pin terminal to provide for flexibility of circuit connections. Outline 8D, OUTLINES SECTION. Tube requires miniature nine-contact socket and may be mounted in any position.

6BJ8

HEATER VOLTS (AC/DC).....	6.3	volts
HEATER CURRENT.....	0.6	ampere
HEATER WARM-UP TIME (Average).....	1.1	seconds
DIRECT INTERELECTRODE CAPACITANCES:		
Triode Unit:		
Grid to Plate.....		pf
Plate to Cathode and Heater.....	2.6	pf
Plate to Cathode and Heater.....	2.8	pf
Diode Units:		
Plate to Cathode and Heater (Each Unit).....	0.31	pf
Cathode to Plate and Heater (Each Unit).....	1.9	pf
Plate of Unit No.1 to Plate of Unit No.2.....	4.5	pf
Plate of Diode Unit No.1 to Triode Grid.....	0.06 max	pf
Plate of Diode Unit No.2 to Triode Grid.....	0.07 max	pf
Plate of Either Diode Unit to All Other Electrodes.....	0.11 max	pf
Cathode of Either Diode Unit to All Other Electrodes.....	3.0	pf
Cathode of Either Diode Unit to All Other Electrodes.....	4.8	pf

TRIODE UNIT AS CLASS A₁ AMPLIFIER

Maximum Ratings, (Design-Maximum Values):

PLATE VOLTAGE.....	330 maz	volts
GRID VOLTAGE, Positive-bias value.....	0 maz	volts
AVERAGE CATHODE CURRENT.....	25 maz	ma
PLATE DISSIPATION.....	4 maz	watts
PEAK HEATER-CATHODE VOLTAGE:		
Heater negative with respect to cathode.....	200 maz	volts
Heater positive with respect to cathode.....	200 maz	volts
Characteristics:		
Plate Voltage.....	90	volts
Grid Voltage.....	0	volts

AVERAGE CHARACTERISTICS

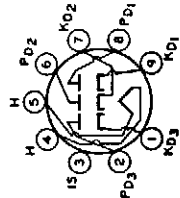
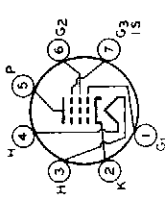
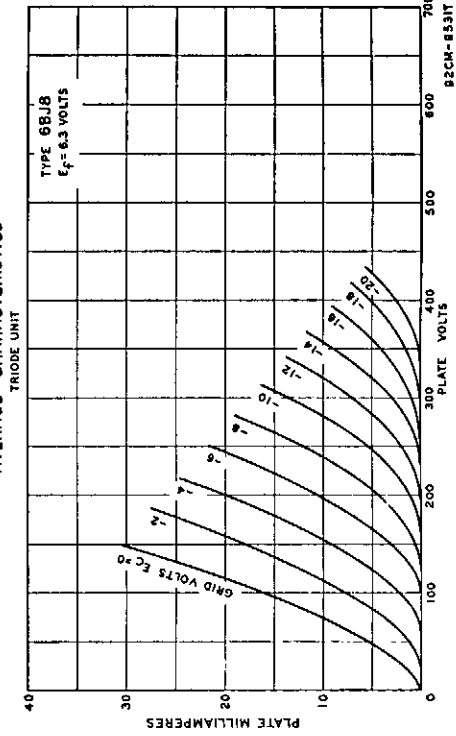

Amplification Factor.....	22
Plate Resistance (Approx.).....	4700
Transconductance.....	4700
Grid Voltage (Approx.) for plate current of 10 ma.....	-18
Plate Current.....	8
Plate Current for grid voltage of -12.5 volts.....	1.7

Maximum Circuit Value:
 Grid-Circuit Resistance..... 1 maz
 The dc component must not exceed 100 volts.

TRIODE UNIT AS VERTICAL DEFLECTION AMPLIFIER

For operation in a 525-line, 50-frame system

Maximum Ratings, (Design-Maximum Values):

DC PLATE VOLTAGE.....	330 maz
PEAK POSITIVE-PULSE PLATE VOLTAGE.....	1200 maz
PEAK NEGATIVE-PULSE GRID VOLTAGE.....	-275 maz
PEAK CATHODE CURRENT.....	77 maz
AVERAGE CATHODE CURRENT.....	22 maz
PLATE DISSIPATION.....	4 maz
PEAK HEATER-CATHODE VOLTAGE.....	200 maz
Heater negative with respect to cathode.....	200* maz
Heater positive with respect to cathode.....	200* maz

Maximum Circuit Value:
 Grid-Circuit Resistance..... 2.2 maz
 For cathode-bias operation..... megohms

DIODE UNITS

Maximum Ratings, (Design-Maximum Values):

PLATE CURRENT (Each Unit):	54 maz
Peak.....	9 maz
Average.....	200 maz
PEAK HEATER-CATHODE VOLTAGE:	200* maz
Heater negative with respect to cathode.....	200* maz
Heater positive with respect to cathode.....	200* maz

The duration of the voltage pulse must not exceed 15 per cent of one vertical scanning cycle. In a 525-line, 30-frame system, 15 per cent of one vertical scanning cycle is 2.5 milliseconds.

The dc component must not exceed 100 volts.

SHARP-CUTOFF BEAM TRIODE

Glass octal type used for the voltage regulation of high-voltage, low-current dc power supplies in color television receivers. Outline 25A, OUTLINES SECTION. Tube requires octal socket and may be mounted in any position.

6BK4

HEATER VOLTAGE (AC/DC).....	6-3
HEATER CURRENT.....	0.2
DIRECT INTERELECTRODE CAPACITANCES (Approx.):	
Grid to Plate.....	0.03 pf
Grid to Cathode and Heater.....	2.6 pf
Plate to Cathode and Heater.....	1 pf
AMPLIFICATION FACTOR (Approx.).....	2000

VOLTAGE-CONTROL SERVICE

Maximum Ratings, (Design-Maximum Values):

DC PLATE VOLTAGE.....	27000 maz
UNREGULATED DC SUPPLY VOLTAGE.....	60000 maz
DC GRID VOLTAGE.....	-135 maz
PEAK GRID VOLTAGE.....	-440 maz
DC PLATE CURRENT.....	1.6 maz
PLATE DISSIPATION.....	25 maz
PEAK HEATER-CATHODE VOLTAGE:	200 maz
Heater negative with respect to cathode.....	200* maz
Heater positive with respect to cathode.....	Not recommended

Maximum Circuit Value:

Grid-Circuit Resistance..... 3 maz
 For use with "Flyback Transformer" high-voltage supply..... megohms
 For use with "Flyback Transformer" high-voltage supply..... megohms
 For interval of 20 seconds maximum duration during equipment warm-up period.

AVERAGE TRANSFER CHARACTERISTICS

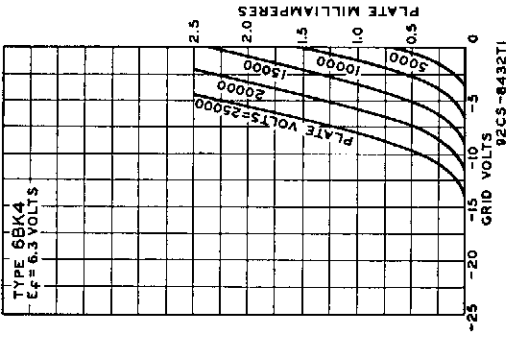

BEAM POWER TUBE

Miniature type used in audio output stages of television and radio receivers. Outline 8D, OUTLINES SECTION. Tube requires miniature nine-contact socket and may be mounted in any position. Heater volts (ac/dc), 6.3; ampere, 1.2. Typical operation as class A₁ amplifier: plate and grid-No.2 volts, 250 maz; grid-No.1 volts, -5; peak at grid-No.1 input, 2.5 dissipation, 9 maz watts; grid-No.2 input, 2.5 maz watts; plate max., 35 (zero-signal), 10 (maximum-signal); 37 (maximum-signal); grid-No.2 max., 3.5 (zero-signal), 10 (maximum-signal); plate resistance (approx.), 0.1 megohm; transconductance, 8500 μ mhos; load resistance, 6500 ohms; total harmonic distortion, 7 per cent; power output, 3.5 watts; peak heater-cathode volts, 100 maz. This type is used principally for renewal purposes.

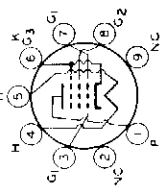

6BK5

Related types:
 12BK5, 25BK5

MEDIUM-MU TWIN TRIODE

Miniature types used in direct-coupled cathode-drive rf amplifier circuits of vhf television tuners. In such circuits, one triode unit is used as the direct-coupled grounded-cathode driver for the other unit. These types are also used in push-pull cathode-drive rf amplifiers. Type 6BK7-B has a controlled heater warm-up time for use in receivers employing series-connected heater strings. Outline 8B, OUTLINES SECTION. Tubes require miniature nine-contact socket and may be mounted in any position. For typical operation as a resistance-coupled amplifier, refer to RESISTANCE-COUPLED AMPLIFIER SECTION. Type 6BK7-A is a DISCONTINUED type listed for reference only.

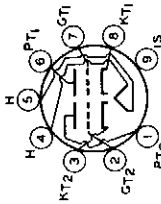

6BK7A

6BK7B

Related type:
 5BK7A

HEATER VOLTAGE (AC/DC).....	6-3	volts
HEATER CURRENT.....	0.45	ampere
HEATER WARM-UP TIME (Average) for 6BK7-B.....	11	seconds
DIRECT INTERELECTRODE CAPACITANCES:		
Grid to Plate.....	1.8	Unit No. 1
Grid to Cathode, Heater, and Internal Shield.....	3	Unit No. 3
Plate to Cathode, Heater, and Internal Shield.....	1	Unit No. 3
Cathode to Grid, Heater, and Internal Shield.....	6	Unit No. 3
Plate to Grid, Heater, and Internal Shield.....	2.4	Unit No. 3

Plate to Cathode.....	0.22	pf
Heater to Cathode.....	3	pf
Grid of Unit No.1 to Grid of Unit No.2.....	0.004 maz	pf
Plate of Unit No.1 to Plate of Unit No.2.....	0.075 maz	pf

CLASS A₁ AMPLIFIER (Each Unit)

Maximum Ratings, (Design-Center Values):		
PLATE VOLTAGE.....	300 maz	volts
GRID VOLTAGE, Negative-bias value.....	2.7 maz	watts
PLATE DISSIPATION.....	200* maz	volts
PEAK HEATER-CATHODE VOLTAGE.....	200* maz	volts
Heater negative with respect to cathode.....		
Heater positive with respect to cathode.....		
Characteristics:		
Plate Supply Voltage.....	150	volts
Cathode-Bias Resistor.....	56	ohms
Amplification Factor.....	43	ohms
Plate Resistance (Approx.).....	4600	ohms
Transconductance.....	9300	ambos
Plate Current.....	18	ma
Grid Voltage (Approx.) for plate current of 10 μ A.....	-11	volts
* In cathode-drive circuits with direct-coupled drive, it is permissible for this voltage to be as high as 300 volts under cutoff conditions.		
† The dc component must not exceed 100 volts.		

HALF-WAVE VACUUM RECTIFIER

Glass octal type used as a damper tube in horizontal deflection circuits of color television receivers. Maximum dimensions: over-all length, 4-5/8 inches; seated height, 4-1/16 inches; diameter, 1-5/8 inches. Tube requires octal socket. Heater volts (ac/dc), 6.3; amperes, 3. Maximum ratings for damper service; peak inverse plate volts (absolute maximum), 4500 maz; peak plate ma., 1200 maz; dc plate ma., 200 maz; plate dissipation, 8 maz watts; peak heater-cathode volts, 4500 absolute maz when heater is negative with respect to cathode (dc component must not exceed 900 volts); 300 maz when heater is positive with respect to cathode (dc component must not exceed 100 volts). This is a DISCONTINUED type listed for reference only.

6BL4

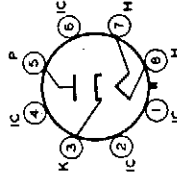

MEDIUM-MU TWIN TRIODE

Glass octal types used as combined vertical deflection amplifier and vertical deflection oscillator in television receivers. When so operated, it is recommended that unit No.1 (pins 4, 5, and 6) be used as the oscillator. Outline 14C, OUTLINES SECTION. Tubes require octal socket and may be mounted in any position. Type 6BL7-GT is a DISCONTINUED type listed for reference only.

6BL7GT

6BL7GTA

HEATER VOLTAGE (AC/DC).....	6.3	volts
HEATER CURRENT.....	1.5	amperes
DIRECT INTERELECTRODE CAPACITANCES (Approx.):		
Grid to Plate.....	6	pf
Grid to Cathode and Heater.....	4.2	pf
Plate to Cathode and Heater.....	0.9	pf
AMPLIFICATION FACTOR*.....	15	
PLATE RESISTANCE (Approx.)*.....	2150	ohms
TRANSCONDUCTANCE*.....	7000	ambos
* Each unit; for plate volts, 250; grid volts, -9; plate ma., 40.		

VERTICAL DEFLECTION OSCILLATOR OR AMPLIFIER*

For operation in a 525-line, 30-frame system	
Maximum Ratings, (Design-Center Values):	Amplifier
DC PLATE VOLTAGE.....	500 maz
PEAK POSITIVE-PULSE PLATE VOLTAGE† (Absolute Maximum).....	2000* maz
PEAK NEGATIVE-PULSE GRID VOLTAGE.....	-250 maz
PEAK CATHODE CURRENT.....	210 maz
AVERAGE CATHODE CURRENT.....	60 maz

PLATE DISSIPATION:		
For both plates with both units operating.....	10 maz	watts
For both plates with both units operating.....	12 maz	watts
PEAK HEATER-CATHODE VOLTAGE:		
Heater negative with respect to cathode.....	200 maz	volts
Heater positive with respect to cathode.....	200* maz	volts

Maximum Circuit Values:		
Grid-Circuit Resistance.....	4.7 maz	4.7 maz
Grid-Circuit Resistance.....	4.7 maz	4.7 maz
* Unless otherwise specified, values are for each unit.		
† The duration of the voltage pulse must not exceed 15 per cent of one vertical scanning cycle. In a 525-line, 30-frame system, 15 per cent of one vertical scanning cycle is 2.5 milliseconds.		
‡ Under no circumstances should this absolute value be exceeded.		
§ The dc component must not exceed 100 volts.		
¶ For cathode-bias operation.		

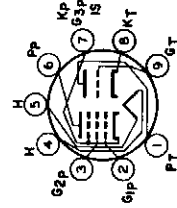

MEDIUM-MU TRIODE—SHARP-CUTOFF PENTODE

Miniature type used in frequency-changer service in television receivers. Outline 8B, OUTLINES SECTION. Tube requires miniature nine-contact socket and may be mounted in any position. Heater volts (ac/dc), 6.3; amperes, 0.45.

6BL8

Related type: 4BL4

CLASS A₁ AMPLIFIER

Maximum Ratings, (Design-Center Values):		
PLATE SUPPLY VOLTAGE.....	100	volts
PLATE VOLTAGE.....	170	volts
GRID-NO.2 (SCREEN-GRID) SUPPLY VOLTAGE.....	-2	volts
With cathode current of 14 ma.....	20	volts
With cathode current less than 10 ma.....	47	volts
CATHODE CURRENT.....	100 maz	ma
GRID-NO.2 INPUT.....	1.5 maz	watt
With plate dissipation greater than 1.2 watts.....	0.5 maz	watt
With plate dissipation less than 1.2 watts.....	0.75 maz	watt
PLATE DISSIPATION.....	1.7 maz	watts
PEAK HEATER-CATHODE VOLTAGE:		
Heater negative with respect to cathode.....	100 maz	volts
Heater positive with respect to cathode.....	100 maz	volts
Characteristics:		
Plate Voltage.....	100	volts
Grid-No.2 Voltage.....	170	volts
Grid-No.1 Voltage.....	-2	volts
Amplification Factor.....	20	
Mu-Factor, Grid No.2 to Grid No.1.....	47	
Plate Resistance (Approx.).....	6200	ohms
Transconductance.....	5000	ambos
Plate Current.....	14	ma
Grid-No.2 Current.....	2.8	ma
Input Resistance at frequency of 50 Mc.....	0.01	megohm
Equivalent Noise Resistance.....	1500	ohms
Maximum Circuit Values:		
Grid-No.1-Circuit Resistance:		
For fixed-bias operation.....	0.5 maz	megohm
For cathode-bias operation.....	0.5 maz	megohm



MEDIUM-MU TRIODE

Miniature types used as rf amplifier tubes in grid-drive circuits of vhf television tuners. The double base-pin connections for both cathode and grid reduce effective lead inductance and

6BN4

6BN4A

Related types: 2BN4A, 3BN4A

lead resistance with consequent reduction in input conductance. In addition, the basing arrangement facilitates isolation of input and output circuits and permits short, direct connections to base-pin terminals. Outline 7B, OUTLINES SECTION. Tubes require miniature seven-contact socket and may be mounted in any position. Type 6BN4 is a DISCONTINUED type listed for reference only.

HEATER VOLTAGE (AC/DC).....	6.3	volts
HEATER CURRENT.....	0.2	ampere
DIRECT INTERELECTRODE CAPACITANCES (Approx.):*		
Grid to Plate.....	1.2	pf
Grid to Cathode and Heater.....	3.2	pf
Plate to Cathode and Heater.....	1.4	pf

* With external shield connected to cathode.

CLASS A₁ AMPLIFIER

Maximum Ratings, (Design-Center Values):		
PLATE VOLTAGE.....	275 maz	volts
GRID VOLTAGE, Positive-bias value.....	0 maz	volts
PLATE DISSIPATION.....	2.2 maz	watts
CATHODE CURRENT.....	22 maz	ma
PEAK HEATER-CATHODE VOLTAGE.....	100 maz	volts
Heater negative with respect to cathode.....	100 maz	volts
Heater positive with respect to cathode.....		
Characteristics:		
Plate-Supply Voltage.....	150	volts
Cathode-Bias Resistor.....	220	ohms
Amplification Factor.....	43	
Plate Resistance (Approx.).....	5400	ohms
Transconductance.....	7700	μmhos
Grid Voltage (Approx.) for plate current of 100 μa.....	-5	volts
Plate Current.....	9	ma
Maximum Circuit Value.....	0.5 maz	megohm
Grid-Circuit Resistance.....		

BEAM TUBE

Miniature type used as combined limiter, discriminator, and audio-voltage amplifier in intercarrier television and FM receivers. Outline 7C, OUTLINES SECTION. Tube requires miniature seven-contact socket and may be mounted in any position. Heater volts (ac/dc), 6.3; amperes, 0.3.

6BN6

Related types:
3BN6, 4BN6

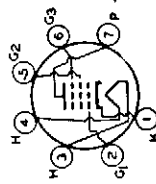

LIMITER AND DISCRIMINATOR SERVICE

Maximum Ratings, (Design-Maximum Values):		
PLATE-SUPPLY VOLTAGE.....	330 maz	volts
GRID-NO.2 VOLTAGE.....	110 maz	volts
GRID-NO.1 VOLTAGE, Positive peak value.....	60 maz	volts
CATHODE CURRENT.....	13 maz	ma
PEAK HEATER CATHODE VOLTAGE.....	200 maz	volts
Heater negative with respect to cathode.....	200 ^o maz	volts
Heater positive with respect to cathode.....		

^o The dc component must not exceed 100 volts.

TWIN DIODE—HIGH-MU TRIODE

Miniature type used in a wide variety of applications in color and black-and-white television receivers. This type has a controlled heater warm-up time for use in receivers employing series-connected heater strings. The triode unit is used in burst-amplifier, of amplifier, and low-frequency oscillator applications. The diode units are used

6BN8

Related type:
8BN8

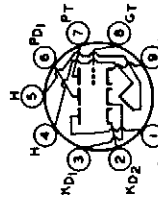

in phase-detector, ratio-detector or discriminator, and horizontal AFC discriminator circuits. Outline 8D, OUTLINES SECTION. Tube requires miniature nine-contact socket and may be mounted in any position.

HEATER VOLTAGE (AC/DC).....	6.3	volts
HEATER CURRENT.....	0.6	ampere
HEATER WARM-UP TIME (Average).....	11	seconds
DIRECT INTERELECTRODE CAPACITANCES:		
Triode Grid to Triode Plate.....	2.5	pf
Triode Grid to Cathode and Heater.....	3.5	pf
Plate to Cathode and Heater.....	0.23	pf
Plate of Diode Unit No.1 to Triode Grid.....	0.06 maz	
Plate of Diode Unit No.2 to Triode Grid.....	0.1 maz	
Diode Cathode to All Other Electrodes (Each Diode Unit).....	0.01 maz	
Diode Plate to Diode Cathode and Heater (Each Diode Unit).....	5	pf
Diode Cathode to Diode Plate and Heater (Each Diode Unit).....	1.3	pf
Diode Plate to All Other Electrodes (Each Diode Unit).....	4.8	pf
Diode Cathode to All Other Electrodes (Each Diode Unit).....	3	pf

TRIODE UNIT AS CLASS A₁ AMPLIFIER

Maximum Ratings, (Design-Maximum Values):

GRID VOLTAGE, Positive bias value.....		
PLATE DISSIPATION.....	330 maz	volts
PEAK HEATER-CATHODE VOLTAGE.....	0 maz	volts
Heater negative with respect to cathode.....	1.7 maz	watts
Heater positive with respect to cathode.....	200 maz	volts
Heater positive with respect to cathode.....	200 ^o maz	volts
Characteristics:		
Plate Voltage.....	250	volts
Grid Voltage.....	-1	volts
Amplification Factor.....	75	
Plate Resistance (Approx.).....	21000	ohms
Transconductance.....	3500	μmhos
Grid Voltage (Approx.) for plate current of 10 μa.....	-2.5	volts
Plate Current.....	1.5	ma
Maximum Circuit Value.....		
Grid-Circuit Resistance.....	1.0 maz	megohm

DIODE UNITS

Maximum Ratings, (Design-Maximum Values):

PLATE CURRENT (Each Unit):		
Peak.....	54 maz	ma
DC.....	9 maz	ma
PEAK HEATER-CATHODE VOLTAGE:		
Heater negative with respect to cathode.....	200 maz	volts
Heater positive with respect to cathode.....	200 ^o maz	volts

■ The dc component must not exceed 100 volts.

AVERAGE CHARACTERISTICS

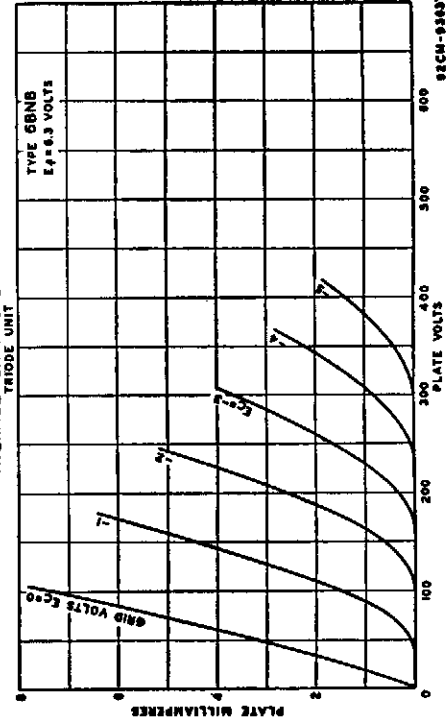

POWER PENTODE

Miniature type used in the output stage of audio-frequency amplifiers. Outline 8E, OUTLINES SECTION. Tube requires miniature nine-contact socket and may be mounted in any position.

6BQ5

Related types:
8BQ5

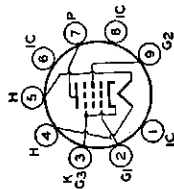

HEATER VOLTAGE (AC/DC).....	6.3	volts
HEATER CURRENT.....	0.76	ampere
DIRECT INTERELECTRODE CAPACITANCES:		
Grid No.1 to Plate.....	0.5 max	pf
Grid No.1 to Cathode, Heater, Grid No.2, and Grid No.3.....	10.8	pf
Plate to Cathode, Heater, Grid No.2, and Grid No.3.....	6.5	pf
Grid No.1 to Heater.....	0.25 max	pf

CLASS A₁ AMPLIFIER

Maximum Ratings, (Design-Center Values):

PLATE VOLTAGE.....	300 max	volts
GRID-No.2 (SCREEN-GRID) VOLTAGE.....	300 max	volts
GRID-No.1 (CONTROL-GRID) VOLTAGE, Positive-bias value.....	0 max	volts
GRID-No.2 INPUT.....	2 max	watts
PLATE DISSIPATION.....	12 max	watts
CATHODE CURRENT.....	65 max	ma
PEAK HEATER-CATHODE VOLTAGE:		
Heater negative with respect to cathode.....	100 max	volts
Heater positive with respect to cathode.....	100 max	volts

* The dc component must not exceed 100 volts.

Typical Operation:

Plate Voltage.....	250	volts
Grid-No.2 Voltage.....	250	volts
Grid-No.1 (Control-Grid) Voltage.....	-7.3	volts
Peak AF Grid-No.1 Voltage.....	6.2	volts
Zero-Signal Plate Current.....	48	ma
Maximum-Signal Plate Current.....	50.6	ma
Zero-Signal Grid-No.2 Current.....	5.5	ma
Maximum-Signal Grid-No.2 Current.....	10	ma
Plate Resistance (Approx.).....	38000	ohms
Transconductance.....	11800	μmhos
Load Resistance.....	4500	ohms
Total Harmonic Distortion.....	10	per cent
Maximum-Signal Power Output.....	5.7	watts

Maximum Circuit Values:

Grid-No.1-Circuit Resistance:	
For fixed-bias operation.....	0.3 max
For cathode-bias operation.....	1.0 max

PUSH-PULL CLASS AB₁ AMPLIFIER

Maximum Ratings: (Same as for single-tube class A₁ amplifier)

Plate Supply Voltage.....	250	volts
Grid-No.2 Supply Voltage.....	250	volts
Cathode-Bias Resistor.....	180	ohms
Peak AF Grid-No.1-to-Grid-No.1 Voltage.....	22.6	volts
Zero-Signal Plate Current.....	62	ma
Maximum-Signal Plate Current.....	75	ma
Zero-Signal Grid-No.2 Current.....	7	ma
Maximum-Signal Grid-No.2 Current.....	15	ma
Effective Load Resistance (Plate-to-plate).....	8000	ohms
Total Harmonic Distortion.....	3	per cent
Maximum-Signal Power Output.....	11	watts

Maximum Circuit Values:

Grid-No.1-Circuit Resistance:	
For fixed-bias operation.....	0.3 max
For cathode-bias operation.....	1.0 max

BEAM POWER TUBE

Glass octal types used as horizontal deflection amplifiers in television receivers. Outline 15C, OUTLINES SECTION. Tubes require octal socket and may be mounted in any position. These types may be supplied with pin No.1 omitted. Type 6BQ6-GT is a DISCONTINUED type listed for reference only.

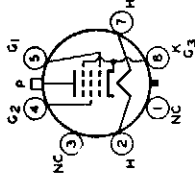

HEATER VOLTAGE (AC/DC).....	6.3	volts
HEATER CURRENT.....	1.2	amperes
DIRECT INTERELECTRODE CAPACITANCES (Approx., 6BQ6-GTB/6CU6):		
Grid No.1 to Plate.....	0.6	pf
Grid No.1 to Cathode, Heater, Grid No.2, and Grid No.3.....	15	pf
Plate to Cathode, Heater, Grid No.2, and Grid No.3.....	7	pf
TRANSCONDUCTANCES* (6BQ6-GTB/6CU6)	5900	μmhos
MU-FACTOR, Grid No.2 to Grid No.1**	4.3	

* For plate volts, 250; grid-No.2 volts, 150; grid-No.1 volts, -22.5; plate ma., 57; grid-No.2 ma., 2.1.

** For plate and grid-No.2 volts, 150; grid-No.1 volts, -22.5.

HORIZONTAL DEFLECTION AMPLIFIER

For operation in a 525-line, 50-frame system
6BQ6-GT

DC PLATE VOLTAGE.....	550 max	volts
PEAK POSITIVE-PULSE PLATE VOLTAGE* (Absolute Maximum).....	5500 max	volts
PEAK NEGATIVE-PULSE PLATE VOLTAGE.....	-1250 max	volts
DC GRID-No.2 (SCREEN-GRID) VOLTAGE.....	175 max	volts
PEAK NEGATIVE-PULSE GRID-No.1 (CONTROL-GRID) VOLTAGE.....	-300 max	volts
PEAK CATHODE CURRENT.....	400 max	ma
AVERAGE CATHODE CURRENT.....	110 max	ma
GRID-No.2 INPUT.....	2.5 max	watts
PLATE DISSIPATION#.....	11 max	watts
PEAK HEATER-CATHODE VOLTAGE:		
Heater negative with respect to cathode.....	200 max	volts
Heater positive with respect to cathode.....	200 max	volts
BULB TEMPERATURE (At hottest point).....	220 max	°C

Maximum Circuit Value:

Grid-No.1-Circuit Resistance.....	0.47 max	megohm
-----------------------------------	----------	--------

* The duration of the voltage pulse must not exceed 15 per cent of one horizontal scanning cycle. In a 525-line, 30-frame system, 15 per cent of one horizontal scanning cycle is 10 microseconds.
† Under no circumstances should this absolute value be exceeded.
‡ An adequate bias resistor or other means is required to protect the tube in the absence of excitation.
§ The dc component must not exceed 100 volts.

MEDIUM-MU TWIN TRIODE

Miniature types used in direct-coupled cathode-drive rf amplifier circuits of vhf television tuners. In such circuits, one triode unit is used as the direct-coupled grounded-cathode driver for the other unit. These types are also used in push-pull cathode-driver rf amplifiers.

Outline 8B, OUTLINES SECTION. Tubes require miniature nine-contact socket and may be mounted in any position. For typical operation as a resistance-coupled amplifier, refer to RESISTANCE-COUPLED AMPLIFIER SECTION. Type 6BQ7 is a DISCONTINUED type listed for reference only.

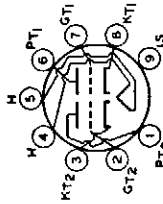

HEATER VOLTAGE (AC/DC).....	6.3	volts
HEATER CURRENT.....	0.4	ampere
DIRECT INTERELECTRODE CAPACITANCES (6BQ7-A):		
Grid to Plate.....	1.2	Unit No.1
Grid to Cathode, Heater, and Internal Shield.....	2.6	Unit No.2
Cathode to Grid, Heater, and Internal Shield.....	5.0	
Plate to Cathode, Heater, and Internal Shield.....	1.2	
Plate to Grid, Heater, and Internal Shield.....	2.2	
Plate to Cathode.....	0.12	
Heater to Cathode (6BQ7-A).....	2.6	
Plate of Unit No.1 to Plate of Unit No.2.....	0.010 max	
Plate of Unit No.2 to Plate and Grid of Unit No.1.....	0.024 max	

6BQ6GT
6BQ6GTB
/6CU6

Related types:
12BQ6GTB/12CU6, 178Q6-GTB, 25BQ6GTB/25CU6

6BQ7
6BQ7A

Related types:
4BQ7A, 5BQ7A

CLASS A₁ AMPLIFIER (Each Unit)

Maximum Ratings, (Design-Center Values):	
PLATE SUPPLY VOLTAGE.....	250 ⁰ max 2 max 20 max
PLATE DISSIPATION.....	200 ⁰ max 200 max
CATHODE CURRENT.....	6.3 1.2
PEAK HEATER-CATHODE VOLTAGE: Heater negative with respect to cathode.....	6.5 9
Heater positive with respect to cathode.....	2.8
Characteristics:	
Plate Supply Voltage.....	150
Cathode-Bias Resistor.....	220
Amplification Factor.....	35
Plate Resistance (Approx.).....	5800
Transconductance.....	6000
Plate Current.....	9
Grid Voltage (Approx.) For plate current of 100 μ a.....	-6.5
For plate current of 10 μ a.....	-10
Maximum Circuit Value:	
Grid-Circuit Resistance.....	0.5 max megohm
* With external shield connected to internal shield.	
* In cathode-drive circuits with direct-coupled drive, it is permissible for this voltage to be as high as 300 volts.	
* The dc component must not exceed 100 volts.	

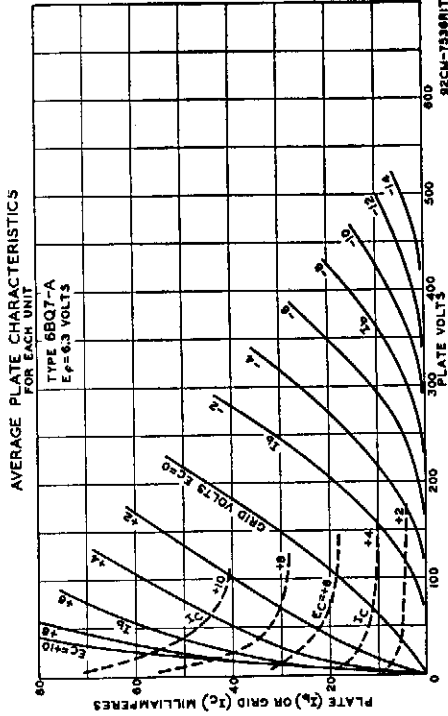

6BR8 MEDIUM-MU TRIODE—SHARP-CUTOFF PENTODE

Miniature types used in a wide variety of applications in color and black-and-white television receivers. Especially useful as combined triode oscillator and pentode mixer in vhf

television tuners. Type 6BR8-A has a controlled heater warm-up time for use in receivers employing series-connected heater strings. Outline 8B, OUTLINES SECTION. Except for basing arrangement and grid-No.1-to-plate capacitance of pentode unit, these types are identical with miniature types 6U8 and 6U8-A, respectively.

HALF-WAVE VACUUM RECTIFIER

Novar type used as damper tube in horizontal-deflection circuits of black-and-white television receivers. Outline 10D, OUTLINES SECTION. Tube requires novar nine-contact socket.

6BS3

Related types: 12BS3, 17BS3

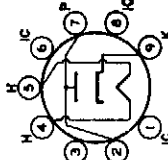

et and may be mounted in any position. Socket terminals 1, 3, 6, and 8 should not be used as tie points; it is recommended that socket clips for these pins be removed to reduce the possibility of arc-over and to minimize leakage. It is especially important that this tube, like other power-handling tubes, be adequately ventilated.

HEATER VOLTAGE (AC/DC).....	6.3	volts
HEATER CURRENT.....	1.2	amperes
DIRECT INTERELECTRODE CAPACITANCES (Approx.):		
Plate to Cathode and Heater.....	6.5	pf
Cathode to Plate.....	9	pf
Heater to Cathode.....	2.8	pf

DAMPER SERVICE

For operation in a 525-line, 30-frame system

Maximum Ratings, (Design-Maximum Values):		
PEAK INVERSE PLATE VOLTAGE.....	5000 max	volts
PEAK PLATE CURRENT.....	1100 max	ma
DC PLATE CURRENT.....	200 max	ma
PLATE DISSIPATION.....	6 max	watts
PEAK HEATER-CATHODE VOLTAGE: Heater negative with respect to cathode.....	5000 ⁰ max	volts
Heater positive with respect to cathode.....	300 ⁰ max	volts
Characteristics, Instantaneous Value:		
Tube Voltage Drop for plate current of 140 ma.....	12	volts
* The duration of the voltage pulse must not exceed 15 per cent of one horizontal scanning cycle. In a 525-line, 30-frame system, 15 per cent of one horizontal scanning cycle is 10 microseconds.		
* The dc component must not exceed 900 volts.		
* The dc component must not exceed 100 volts		

MEDIUM-MU TWIN TRIODE

Miniature type used in direct-coupled cathode-drive rf amplifier circuits of vhf television tuners. In such circuits, one triode unit is used as the direct-coupled grounded-cathode driver for the other unit. This type is also used in push-pull cathode-drive rf amplifiers. Outline 8B, OUTLINES SECTION. Tube requires miniature nine-contact socket and may be mounted in any position. Heater volts (ac/dc), 6.3; amperes, 0.4.



6BS8

Related type: 4BS8

CLASS A₁ AMPLIFIER (Each Unit)

Maximum Ratings, (Design-Center Values):		
PLATE VOLTAGE.....	150 max	volts
PLATE DISSIPATION.....	2 max	watts
CATHODE CURRENT.....	20 max	ma
PEAK HEATER-CATHODE VOLTAGE: Heater negative with respect to cathode.....	200 max	volts
Heater positive with respect to cathode.....	200 max	volts
Characteristics:		
Plate-Supply Voltage.....	150	volts
Cathode-Bias Resistor.....	220	ohms
Amplification Factor.....	36	
Plate Resistance (Approx.).....	5000	ohms
Transconductance.....	7200	μmhos
Plate Current.....	10	ma
Grid Voltage (Approx.) for plate current of 10 μ a*.....	-7	volts
Maximum Circuit Value:		
Grid-Circuit Resistance.....	0.5 max	megohm

* This value applies to unit No.2 only.

SHARP-CUTOFF TWIN PENTODE

Miniature type used as combined sync separator, sync clipper, and agc amplifier tube in television receivers. Outline 8D, OUTLINES SECTION. Tube requires miniature nine-contact socket and may be mounted in any position.

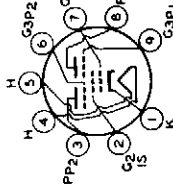

6BU8

Related types: 3BU8, 4BU8

HEATER VOLTAGE (AC/DC).....	6.3	volts
HEATER CURRENT.....	0.3	ampere
DIRECT INTERELECTRODE CAPACITANCES:		
Grid No.3 to Plate (Each Unit).....	1.9	pf
Grid No.1 to All Other Electrodes (Each Unit).....	3.6	pf
Plate to All Other Electrodes (Each Unit).....	3	pf
Grid No.3 of Unit No.1 to Grid No.3 of Unit No.2.....	0.015	macr

CLASS A₁ AMPLIFIER

Maximum Ratings, (Design-Maximum Values):

PLATE VOLTAGE (Each Unit).....	300	macr
GRID-NO.3 (SUPPRESSOR-GRID) VOLTAGE (Each Unit):		
Peak positive value.....	50	macr
DC negative value.....	-50	macr
DC positive value.....	3	macr
GRID-NO.2 (SCREEN-GRID) VOLTAGE.....	150	macr
GRID-NO.1 (CONTROL-GRID) VOLTAGE, Negative bias value.....	-50	macr
CATHODE CURRENT.....	12	macr
GRID-NO.2 INPUT.....	0.75	macr
PLATE DISSIPATION (Each Unit).....	1.1	watt
PEAK HEATER-CATHODE VOLTAGE:		
Heater negative with respect to cathode.....	200	macr
Heater positive with respect to cathode.....	200	macr

With Both Units Operating

Characteristics:		
Plate Voltage (Each Unit).....	100	volts
Grid-No.3 Voltage (Each Unit).....	-10	volts
Grid-No.2 Voltage.....	87.5	volts
Grid-No.1 Voltage.....	*	volts
Grid-No.1 Voltage.....	2.2	ma
Plate Current (Each Unit).....	3.3	ma
Grid-No.2 Current.....	7.8	ma
Cathode Current.....		

With One Unit Operating†

Plate Voltage.....	100	volts
Grid-No.3 Voltage.....	0	volts
Grid-No.2 Voltage.....	87.5	volts
Grid-No.1 Voltage.....	0	volts
Grid-No.3 Transconductance.....	180	μmhos
Grid-No.1 Transconductance.....	2.2	ma
Plate Current.....	-4.5	volts
Grid-No.3 Voltage (Approx.) for plate current of 100 μa.....	-2.3	volts
Grid-No.1 Voltage (Approx.) for plate current of 100 μa.....		

AVERAGE CHARACTERISTICS WITH EC₁ AS VARIABLE

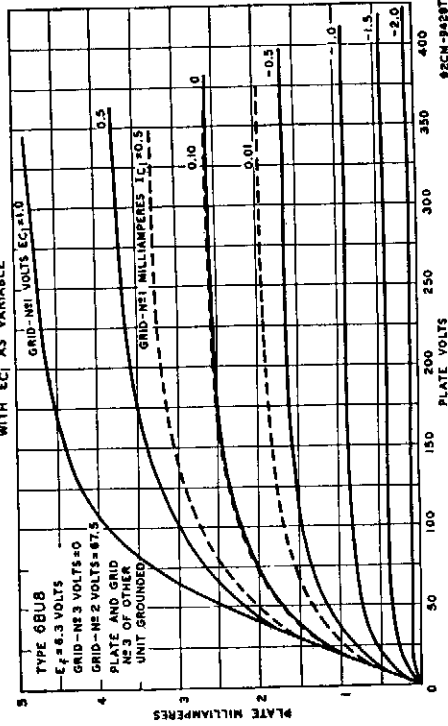

Maximum Circuit Values:

Grid-No.3-Circuit Resistance (Each Unit).....	0.5	macr
Grid-No.1-Circuit Resistance.....	0.5	macr
* The dc component must not exceed 100 volts.		
† A adjusted to give a dc grid-No.1 current of 100 microamperes.		
‡ With plate and grid No.3 of the other unit connected to ground.		

AVERAGE CHARACTERISTICS WITH EC₃ AS VARIABLE

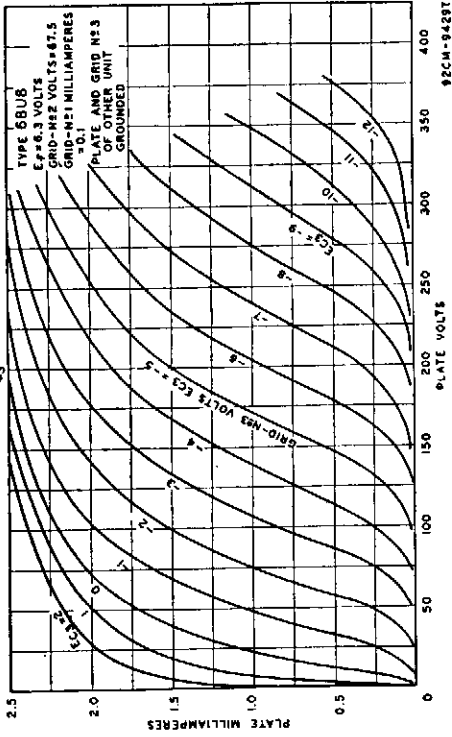

TWIN DIODE—MEDIUM-MU TRIODE

Miniature type used as combined synchronous detector and chrominance amplifier in color television receivers; also used as combined FM detector and af voltage amplifier. Tube has controlled warm-up time for use in series-connected heater strings.

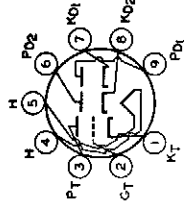

OUTLINE SECTION. Tube requires miniature nine-contact socket and may be operated in any position. Heater volts (ac/dc), 6.3; amperes, 0.6; warm-up time (average), 11 seconds.

TRIODE UNIT AS CLASS A₁ AMPLIFIER

Maximum Ratings, (Design-Maximum Values):

PLATE VOLTAGE.....	330	macr	volts
GRID VOLTAGE, Positive-bias value.....	0	macr	volts
PLATE DISSIPATION.....	2.7	macr	watts
PEAK HEATER-CATHODE VOLTAGE:			
Heater negative with respect to cathode.....	200	macr	volts
Heater positive with respect to cathode.....	200	macr	volts

Characteristics:

Plate Voltage.....	75	volts
Grid Voltage.....	0	volts
Cathode Resistor.....	330	ohms
Amplification Factor.....	33	
Plate Resistance (Approx.).....	5900	ohms
Transconductance.....	5600	μmhos
Plate Current.....	11	ma
Grid Voltage (Approx.) for plate current of 100 μa.....	-11	volts

Maximum Circuit Values:

Grid-Circuit Resistance.....	0.1	macr	megohm
For fixed-bias operation.....	0.5	macr	megohm
For cathode-bias operation.....			

6B8V

DIODE UNITS—TWO

Values are for each unit

Maximum Ratings, (Design-Maximum Values):

PLATE CURRENT.....	10 maz	ma
PEAK HEATER-CATHODE VOLTAGE:	200 maz	volts
Heater negative with respect to cathode.....	200 ^o maz	volts
Heater positive with respect to cathode.....		
Characteristics, Instantaneous Test Condition:		
Tube Voltage Drop for plate current of 25 ma.....	5	volts
The dc component must not exceed 100 volts.		

FULL-WAVE VACUUM RECTIFIER

Miniature type used in full-wave power supplies having high dc output current requirements. Outline 8D, OUTLINES SECTION. Type 6BW4 requires miniature nine-contact socket and may be mounted in any position. It is especially important that this tube, like other power-handling tubes, be adequately ventilated. Heater volts (ac/dc), 6.3; amperes, 0.9.

6BW4

Related type: 12BW4

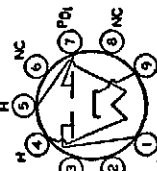

FULL-WAVE RECTIFIER

Maximum Ratings, (Design-Center Values):

PEAK INVERSE PLATE VOLTAGE.....	1275 maz	volts
AC PLATE SUPPLY VOLTAGE (Per Plate, rms).....	450 maz	volts
STEADY-STATE PEAK PLATE CURRENT (Per Plate).....	350 maz	ma
DC OUTPUT CURRENT.....	62.5 maz	ma
TRANSIENT PEAK PLATE CURRENT (Per Plate).....	2 maz	amperes
DC HEATER-CATHODE VOLTAGE:		
Heater negative with respect to cathode.....	450 maz	volts

Typical Operation:

AC Plate-To-Plate Supply Voltage (rms)*.....	650	volts
Filter Input Capacitor.....	40	ohms
Total Effective Plate Supply Resistance per Plate.....	82	henries
Filter Input Choke.....	100	ma
DC Output Current.....	330	volts
DC Output Voltage at Input to Filter (Approx.).....		
* AC plate supply voltage is measured without load.		

TWIN DIODE—

SHARP-CUTOFF PENTODE

Miniature type used in television receivers; diodes are used as horizontal phase detectors; pentode is used as a sound if amplifier, sound limiter, and agc keyer. Outline 8B, OUTLINES SECTION. Heater volts (ac/dc), 6.3; amperes, 0.45. Tube requires nine-contact socket and may be operated in any position.

6BW8

Related type: 5BW8

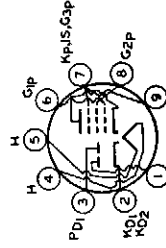

PENTODE UNIT AS CLASS A1 AMPLIFIER

Maximum Ratings, (Design-Maximum Values):

PLATE VOLTAGE.....	330 maz	volts
GRID-NO.2 (SCREEN-GRID) SUPPLY VOLTAGE.....	330 maz	volts
GRID-NO.2 VOLTAGE.....	See curve page 70	
GRID-NO.1 (CONTROL-GRID) VOLTAGE:		
Positive-bias value.....	0 maz	volts
Negative-bias value.....	-55 maz	volts
GRID-NO.2 INPUT:		
For grid-No.2 voltages up to 165 volts.....	0.55 maz	watt
For grid-No.2 voltages between 165 and 330 volts.....	See curve page 70	
PLATE DISSIPATION.....	3 maz	watts
PEAK HEATER-CATHODE VOLTAGE:		
Heater negative with respect to cathode.....	200 maz	volts
Heater positive with respect to cathode.....	200 ^o maz	volts

Characteristics:

Plate Voltage.....	250	volts
Grid-No.2 Voltage.....	110	volts
Cathode-Bias Resistor.....	68	ohms
Plate Resistance (Approx.).....	0.25	megohm

Transconductance.....	5200	μmhos
Grid-No.1 Voltage (Approx.) for plate current of 10 ma.....	-10	volts
Plate Current.....	10	ma
Grid-No.2 Current.....	3.5	ma

Maximum Circuit Values:

Grid-No.1 Circuit Resistance:		
For fixed-bias operation.....	0.1 maz	megohm
For cathode-bias operation.....	0.5 maz	megohm

DIODE UNITS (Each Unit)

Maximum Ratings, (Design-Maximum Values):

PLATE CURRENT.....	5 maz	ma
PEAK HEATER-CATHODE VOLTAGE:		
Heater negative with respect to cathode.....	200 maz	volts
Heater positive with respect to cathode.....	200 ^o maz	volts
The dc component must not exceed 100 volts.		

MEDIUM-MU TWIN TRIODE

Glass octal type used as combined vertical deflection amplifier and vertical deflection oscillator in television receivers. When so operated, it is recommended that unit No.1 (pins 4, 5, and 6) be used as the oscillator. Outline 14C, OUTLINES SECTION. Tube requires octal socket and may be mounted in any position.

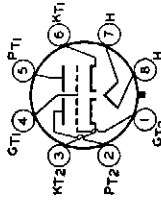

HEATER VOLTAGE (AC/DC).....	6.3	volts
HEATER CURRENT.....	1.5	amperes
AMPLIFICATION FACTOR*.....	10	
PLATE RESISTANCE (Approx.)*.....	1300	ohms
TRANSCONDUCTANCE*.....	7600	μmhos

* For plate volts, 250; cathode-bias resistor, 390 ohms; plate ma., 42.

VERTICAL DEFLECTION OSCILLATOR OR AMPLIFIER (Each Unit)

For operation in a 525-line, 50-frame system

Maximum Ratings, (Design-Center Values):		
DC PLATE VOLTAGE.....	500 maz	volts
PEAK POSITIVE-PULSE PLATE VOLTAGE (Absolute Maximum)†.....	-400 maz	volts
PEAK NEGATIVE-PULSE GRID VOLTAGE.....	180 maz	ma
AVERAGE CATHODE CURRENT.....	60 maz	ma
PLATE DISSIPATION:		
For either plate.....	10 maz	watts
For both plates with both units operating.....	12 maz	watts
PEAK HEATER-CATHODE VOLTAGE:		
Heater negative with respect to cathode.....	200 maz	volts
Heater positive with respect to cathode.....	200 ^o maz	volts

Maximum Circuit Values:

Grid-Circuit Resistance.....	2.2 maz	megohms
The duration of the voltage pulse must not exceed 15 per cent of one vertical scanning cycle. In a 525-line, 30-frame system, 15 per cent of one vertical scanning cycle is 2.5 milliseconds.		
Under no circumstances should this absolute value be exceeded.		
The dc component must not exceed 100 volts.		

FULL-WAVE VACUUM RECTIFIER

Octal type having high pervance used as damper tube in horizontal deflection circuits of television receivers or as a rectifier in conventional power-supply applications. Outline 19A, OUTLINES SECTION. Tube requires octal socket and may be mounted in any position. It is especially important that this tube, like other power-handling tubes, be adequately ventilated. Heater volts (ac/dc), 6.3; amperes, 1.6. Maximum ratings for damper service (each unit): peak inverse plate volts (absolute maximum), 3000 maz; peak plate ma., 525 maz; dc plate ma., 175 maz. Peak heater-cathode volts: heater negative with respect to cathode, 450 maz; heater positive with respect to cathode, 100 maz. This type is used principally for renewal purposes.

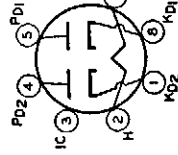

6BY5GA

PENTAGRID AMPLIFIER

Miniature type used as a gated amplifier in color television receivers. In such service, it may be used as a combined sync separator and sync clipper. Outline 7B, OUTLINES SECTION. Tube requires miniature seven-contact socket and may be mounted in any position.

6BY6

Related type:
3BY6

HEATER VOLTAGE (AC/DC) volts
HEATER CURRENT ampere

DIRECT INTERELECTRODE CAPACITANCES:
Grid No.1 to Plate 0.08 max pf
Grid No.3 to Plate 0.35 max pf
Grid No.1 to Grid No.3 0.22 max pf
Grid No.1 to All Other Electrodes 5.4 pf
Grid No.3 to All Other Electrodes 6.9 pf
Plate to All Other Electrodes 7.5 pf

CLASS A₁ AMPLIFIER

Characteristics:
Plate Voltage 250 volts
Grids-No.2-and-No.4 Voltage 100 volts
Grid-No.3 Voltage -2.5 volts
Grid-No.1 Voltage -2.5 volts
Grid-No.3-to-Plate Transconductance 500 μ mhos
Grid-No.1-to-Plate Transconductance 1900 μ mhos
Plate Current 6.5 ma
Grids-No.2-and-No.4 Current 9 ma
Grid-No.3 Volts (Approx.) for plate current of 35 μ a and grid-No.1 volts = -4
Grid-No.1 Volts (Approx.) for plate current of 35 μ a and grid-No.3 volts = 0.

GATED AMPLIFIER

Maximum Ratings, (Design-Maximum Values):
Plate Voltage 330 max volts
Grids-No.2-AND-No.4 VOLTAGE See curve page 70
Grids-No.2-AND-No.4 SUPPLY VOLTAGE 330 max volts
Grid-No.3 VOLTAGE:
Negative bias value -55 max volts
Positive bias value 0 max volts
Positive peak value 27 max volts
Grid-No.1 VOLTAGE, Negative bias value -110 max volts
Plate Dissipation 2.3 max watts
Grid-No.3 INPUT 0.1 max watt
Grids-No.2-AND-No.4 INPUT 1.1 max watts
For grids-No.2-and-No.4 voltages between 165 and 330 volts See curve page 70

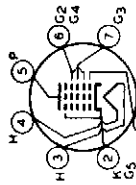
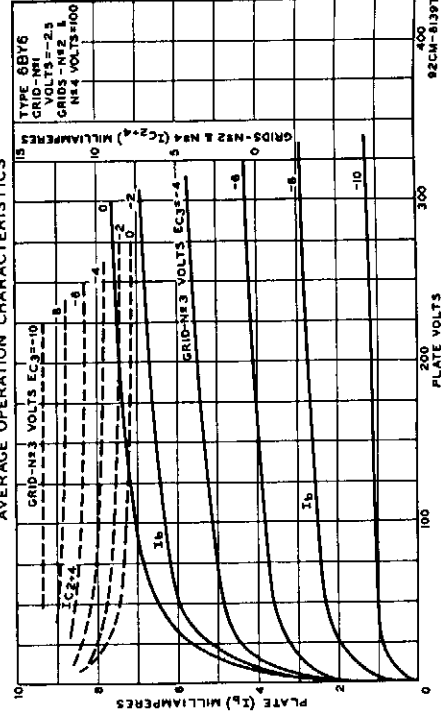

Grid-No.1 INPUT 0.1 max watt
Peak Heater-Cathode Voltage:
Heater negative with respect to cathode 200 max
Heater positive with respect to cathode 200 max
Characteristics as Sync Separator and Sync Clipper:
Plate Voltage 10 volts
Grid-No.3 Voltage 0 volts
Grids-No.2-and-No.4 Voltage 25 volts
Grid-No.1 Voltage 0 volts
Plate Current 1.4 ma
Grids-No.2-and-No.4 Current 3.5 ma
Grid-No.3 Volts (Approx.) for plate voltage of 25 volts, grids-No.2-and-No.4 voltage of 0 volts, and plate current of 50 μ a -2.5 volts
Grid-No.1 Volts (Approx.) for plate voltage of 25 volts, grids-No.2-and-No.4 voltage of 25 volts, grid-No.3 voltage of 0 volts, and plate current of 50 μ a -2.3 volts
Maximum Circuit Values:
Grid-No.1 or Grid-No.3-Circuit Resistance:
For fixed-bias operation 0.5 max megohm
For cathode-bias operation 1.0 max megohm
* The dc component must not exceed 100 volts.

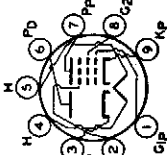

DIODE—SHARP-CUTOFF PENTODE

Miniature type used in diversified applications in television receivers. The pentode unit is used as an rf amplifier and the high-perveance diode as a limiter or detector. This type has a

controlled heater warm-up time for use in receivers employing series-connected heater strings. Outline 8D, OUTLINES SECTION. Tube requires miniature nine-contact socket and may be mounted in any position. Heater volts (ac/dc), 6.3; amperes, 0.6; warm-up time (average), 11 seconds.

PENTODE UNIT AS CLASS A₁ AMPLIFIER

Maximum Ratings, (Design-Center Values):
Plate Voltage 300 max volts
Grids-No.3 (suppressor-grid) VOLTAGE, Positive value 0 max volts
Grids-No.2 VOLTAGE, Positive value 300 max volts
Grid-No.2 VOLTAGE See curve page 70
Grid-No.1 (control-grid) VOLTAGE:
Negative bias value -50 max volts
Positive bias value 3 max watts
Plate Dissipation 0.65 max watt
Grids-No.2 INPUT See curve page 70
Peak Heater-Cathode Voltage:
Heater negative with respect to cathode 200 max volts
Heater positive with respect to cathode 200 max volts

Characteristics:
Plate Supply Voltage 100 volts
Grid No.3 Connect to cathode at socket
Grid No.2 Supply Voltage 100 volts
Cathode-Bias Resistor 150 ohms
Plate Resistance (Approx.) 68 ohms
Transconductance (Approx.) 1 megohm
Grid-No.1 Voltage (Approx.) for plate current of 10 μ a 5200 μ mhos
Plate Current -6.5 volts
Grid-No.2 Current 10.6 ma
Maximum Circuit Values:
Grid-No.1-Circuit Resistance:
For fixed-bias operation 0.25 max megohm
For cathode-bias operation 1.0 max megohm
* The dc component must not exceed 100 volts.

DIODE UNIT

Maximum Ratings, (Design-Center Values):
Peak Inverse Plate Voltage 430 max volts
Peak Plate Current 180 max ma
DC Plate Current 45 max ma
Peak Heater-Cathode Voltage:
Heater negative with respect to cathode 200 max volts
Heater positive with respect to cathode 200 max volts
* The dc component must not exceed 100 volts.

SEMIREMOTE-CUTOFF PENTODE

Miniature type used in gain-controlled video if stages of television receivers. Outline 7B, OUTLINES SECTION. Tube requires miniature seven-contact socket and may be mounted in any position.

6BZ6

Related types:
3BZ6, 4BZ6, 12BZ6

- HEATER VOLTAGE (AC/DC)..... volts
HEATER CURRENT..... ampere
- Without Shield.....
With Shield.....
- DIRECT INTERELECTRODE CAPACITANCES:
- Grid No.1 to Plate..... pf
 - Grid No.1 to Cathode, Heater, Grid No.2, Grid No.3, and Internal Shield..... pf
 - Plate to Cathode, Heater, Grid No.2, Grid No.3, and Internal Shield..... pf

CLASS A₁ AMPLIFIER

- Maximum Ratings, (Design-Maximum Values):
- PLATE VOLTAGE..... volts
 - GRID-NO.3 (SUPPRESSOR-GRID) VOLTAGE, Positive Value..... volts
 - GRID-NO.2 (SCREEN-GRID) SUPPLY VOLTAGE..... volts
 - GRID-NO.1 VOLTAGE..... volts
 - GRID-NO.1 (CONTROL-GRID) VOLTAGE, Positive bias value..... volts
 - PLATE DISSIPATION..... watts
 - GRID-NO.2 INPUT..... watt
- For grid-No.2 voltages up to 165 volts. See curve page 70
- For grid-No.2 voltages between 165 and 330 volts. See curve page 70
- PEAK HEATER-CATHODE VOLTAGE:
Heater negative with respect to cathode..... volts
Heater positive with respect to cathode..... volts

- Characteristics:
- Plate Supply Voltage..... Connected
 - Grid-No.3..... 125 volts
 - Grid-No.2 Supply Voltage..... 125 volts
 - Cathode-Bias Resistor..... 156 ohms
 - Plate Resistance (Approx.)..... 0.26 megohm
 - Transconductance..... 8000 μ mhos
 - Grid-No.1 Voltage (Approx.) for transconductance of 50 μ mhos and cathode resistor of 0 ohms..... -4.5 volts
 - Plate Current..... 14 ma
 - Grid-No.2 Current..... 3.6 ma

- Maximum Circuit Values:
- Grid-No.1-Circuit Resistance:
For fixed-bias operation..... 0.25 maz
 - For cathode-bias operation..... 1.0 maz
- * The dc component must not exceed 100 volts.

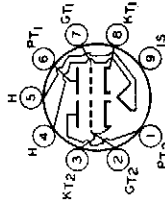
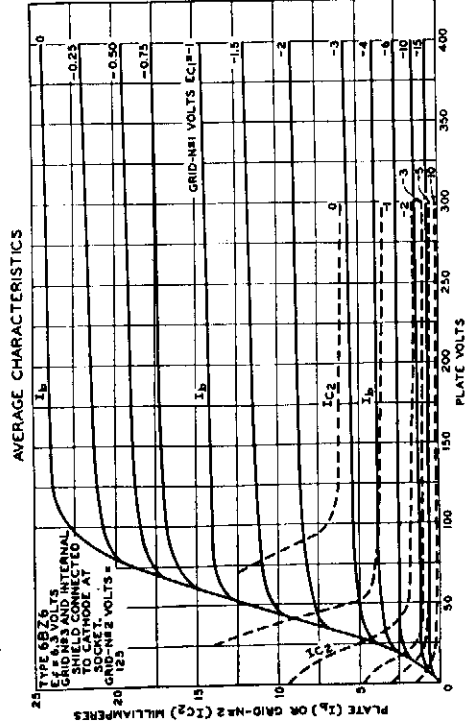

MEDIUM-MU TWIN TRIODE

Miniature type used in direct-coupled cathode-drive rf amplifier circuits of vhf television tuners. In such circuits, one triode unit is used as a direct-coupled grounded-cathode driver for the other unit. This type is also used in push-pull cathode-drive rf amplifiers. Outline 8B, OUTLINES SECTION. Tube requires miniature nine-contact socket and may be mounted in any position. For typical operation as a resistance-coupled amplifier, refer to RESISTANCE-COUPLED AMPLIFIER SECTION. Heater volts (ac/dc), 6.3; amperes, 0.4.

6BZ7

Related type:
4BZ7

CLASS A₁ AMPLIFIER (Each Unit)

- Maximum Ratings, (Design-Center Values):
- PLATE VOLTAGE..... 250^{max} volts
 - PLATE DISSIPATION..... 2.0^{max} watts
 - CATHODE CURRENT..... 20^{max} ma
 - PEAK HEATER-CATHODE VOLTAGE:
Heater negative with respect to cathode..... 200^{max} volts
 - Heater positive with respect to cathode..... 200^{max} volts
- * In cathode-drive circuits with direct-coupled drive, it is permissible for this voltage to be as high as 300 volts under cutoff conditions.
- * The dc component must not exceed 100 volts.
- Characteristics:
- Plate Supply Voltage..... 150 volts
 - Cathode-Bias Resistor..... 220 ohms
 - Amplification Factor..... 36
 - Plate Resistance (Approx.)..... 5300 ohms
 - Transconductance..... 6800 μ mhos
 - Plate Current..... 10 ma
 - Grid Voltage (Approx.) for plate current of 100 μ a..... -7 volts
- Maximum Circuit Value:
Grid-Circuit Resistance..... 0.5 maz megohm

AVERAGE CHARACTERISTICS EACH UNIT

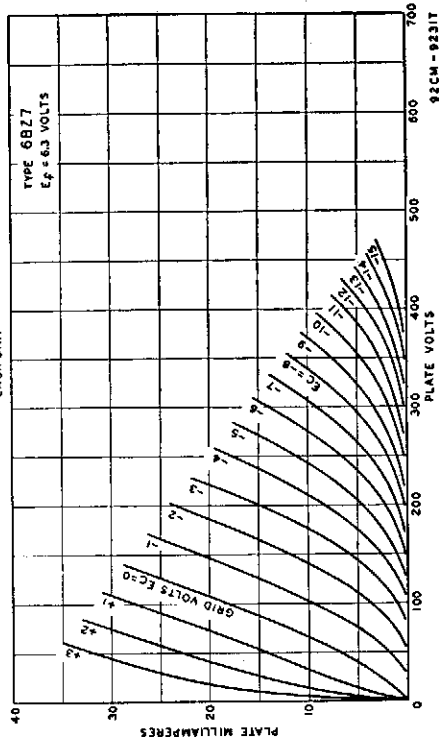

MEDIUM-MU TWIN TRIODE

Miniature type used in direct-coupled, cathode-drive, rf amplifier circuits in vhf television tuners. In such circuits, one triode unit is used as the direct-coupled, grounded-cathode driver for the other unit. Outline 8B, OUTLINES SECTION. Tube requires miniature nine-contact socket. Heater volts (ac/dc), 6.3; amperes, 0.4. Characteristics as class A₁ amplifier (each unit): plate supply volts, 125 (250 maz); cathode-bias

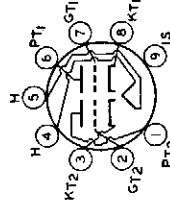

6BZ8

resistor, 100 ohms; amplification factor, 45; plate resistance (approx.), 5600 ohms; transconductance, 8000 μ mhos; plate ma., 10; cathode ma., 20 m az; plate dissipation, 2.2 m az watts; peak heater-cathode volts, 200 m az. Type 6B28 is used principally for renewal purposes.

POWER TRIODE

Miniature type used in compact radio equipment as a local oscillator in FM and other high-frequency circuits. It may also be used as a class C rf amplifier. In such service, it delivers a power output of 5.5 watts at moderate frequencies, and 2.5 watts at 150 megacycles per second. Outline 7B, OUTLINES SECTION. Tube requires miniature seven-contact socket and may be mounted in any position. For typical operation as a resistance-coupled amplifier, refer to RESISTANCE-COUPLED AMPLIFIER SECTION. For additional curve of plate characteristics, refer to type 12AU7-A.

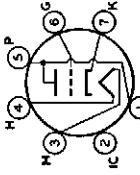

HEATER VOLTAGE (AC/DC)..... 6.3 volts
HEATER CURRENT..... 0.15 ampere

	Without External Shield	With External Shield*
Grid to Plate	1.6	1.8
Grid to Cathode and Heater	1.8	1.8
Plate to Cathode and Heater	1.3	2.5

DIRECT INTERELECTRODE CAPACITANCES (Approx.):

Grid to Plate	pf
Grid to Cathode	pf
Plate to Cathode and Heater	pf

* With external shield connected to cathode.

CLASS A₁ AMPLIFIER

Maximum Ratings, (Design-Center Values):

PLATE VOLTAGE..... 300 m az
PLATE DISSIPATION..... 3.5 m az watts

PEAK HEATER-CATHODE VOLTAGE:

Heater negative with respect to cathode	200 m az volts
Heater positive with respect to cathode	200 m az volts

Characteristics:

Plate Voltage	100	250
Grid Voltage	0	-8.5
Amplification Factor	19.5	17
Plate Resistance (Approx.)	6250	7700
Transconductance	3100	2200
Plate Current	11.8	10.5
Grid Voltage (Approx.) for plate current of 10 μ a.	-10	-25

* Transformer- or impedance-type input coupling devices are recommended to minimize resistance in the grid circuit.

Maximum Circuit Values:

Grid-Circuit Resistances:

For fixed bias operation	0.25 m az megohm
For cathode-bias operation	1.0 m az megohm

■ The dc component must not exceed 100 volts.

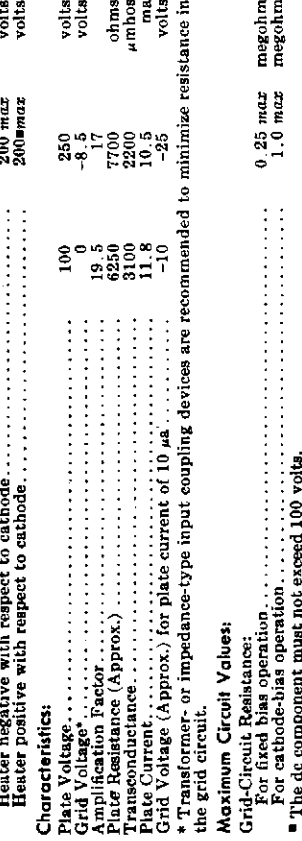

6C4

RF POWER AMPLIFIER AND OSCILLATOR—Class C Telegraphy

Maximum Ratings, (Design-Center Values):

PLATE VOLTAGE	300 m az volts
GRID VOLTAGE	-50 m az volts
PLATE CURRENT	25 m az ma
GRID CURRENT	8 m az ma
PLATE DISSIPATION	5 m az watts

Typical Operation at frequencies up to 50 Mc:

Plate Voltage	300 volts
Grid Voltage	-27 volts
Plate Current	25 ma
Grid Current (Approx.)	7 ma
Driving Power (Approx.)	0.35 watt
Power Output (Approx.)	5.5 watts

● Approximately 2.5 watts power output can be obtained when the 6C4 is used at 150 megacycles as an oscillator with grid resistor of 10,000 ohms and with maximum rated input.

MEDIUM-MU TRIODE

Metal type 6C5 and glass octal type 6C5-GT used as audio amplifier, oscillator, or detector tubes. Outlines 3 and 24, respectively, OUTLINES SECTION. Tubes require octal socket. Heater volts (ac/dc), 6.3; amperes, 0.3. Typical operation as class A₁ amplifier: plate volts, 250 (300 m az); grid volts, -8 (0 m az); amplification factor, 20; plate resistance, 10000 ohms; transconductance, 2000 μ mhos; plate ma., 8; plate dissipation, 2.5 m az watts. Type 6C5-GT is a DISCONTINUED type listed for reference only. Type 6C5 is used principally for renewal purposes.

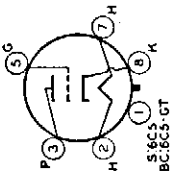

6C5
6C5GT

SHARP-CUTOFF PENTODE

Glass type used as biased detector and as high-gain amplifier in radio equipment. Outline 24A, OUTLINES SECTION. Tube requires six-contact socket. Heater volts (ac/dc), 6.3; amperes, 0.3. For ratings and typical operation data, refer to type 6J7. Type 6C6 is used principally for renewal purposes.

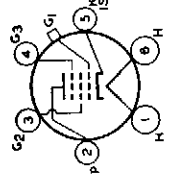

6C6

TWIN DIODE—MEDIUM-MU TRIODE

Glass type used as combined detector, amplifier, and arc tube. Outline 24B, OUTLINES SECTION. Heater volts (ac/dc), 6.3; amperes, 0.3. This type is similar to, but not interchangeable with, type 85. The 6C7 is a DISCONTINUED type listed for reference only.

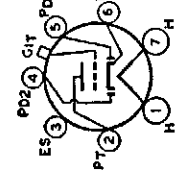

6C7

MEDIUM-MU TWIN TRIODE

Glass octal type used as a voltage amplifier and phase inverter in radio equipment. Outline 28, OUTLINES SECTION. Tube requires octal socket. Heater volts (ac/dc), 6.3; amperes, 0.3. Maximum ratings for each triode unit as class A₁ amplifier: plate volts, 250 m az; grid volts, positive-bias value, 0 m az; plate dissipation, 1.0 m az watt. Typical operation: plate volts, 250; grid volts, -4.5; plate ma., 3.2; plate resistance, 22500 ohms; amplification factor, 36; transconductance, 1600 μ mhos. This type is used principally for renewal purposes.

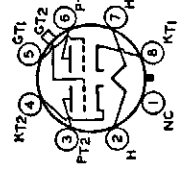

6C8G

SHARP-CUTOFF DUAL TETRODE

Miniature type used as vhf rf-amplifier and autodyne mixer tube. Outline 8B, OUTLINES SECTION, except center pin is added to base. Tube requires miniature ten-contact socket and may be mounted in any position. Heater volts (ac/dc), 6.3; amperes, 0.4.

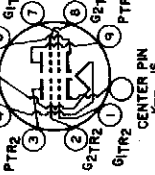

6C9

Related type: 17C9

CLASS A₁ AMPLIFIER (Earth Unit)

Maximum Ratings, (Design-Maximum Values):
 PLATE VOLTAGE volts
 GRID-NO.2 (SCREEN-GRID) SUPPLY VOLTAGE volts
 See curve page 70
 GRID-NO.2 VOLTAGE ma
 CATHODE CURRENT ma
 PLATE DISSIPATION:
 Either plate watts
 Both plates (both units operating) watts
 For grid-No.2 voltages up to 90 volts watt
 For grid-No.2 voltages between 90 and 180 volts watt
 See curve page 70
 PEAK HEATER-CATHODE VOLTAGE:
 Heater negative with respect to cathode volts
 Heater positive with respect to cathode volts

Characteristics:
 Plate Voltage volts
 80 volts
 -1 volt
 0.1 megohm
 8000 μmhos
 10 ma
 1.5 ma
 -6 volts
 Grid-No.2 Current ma
 Grid-No.1 Voltage (Approx.) for plate current of 20 μa volts

6CA4 FULL-WAVE VACUUM RECTIFIER

Miniature type used in power-supply of compact, audio equipment having moderate requirements. Outline 8E, OUTLINES SECTION. Tube requires miniature nine-contact socket

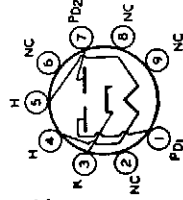

FULL-WAVE RECTIFIER

Maximum Ratings, (Design-Center Values):
 PEAK INVERSE PLATE VOLTAGE volts
 PEAK PLATE CURRENT (Per Plate) ma
 AC PLATE SUPPLY VOLTAGE (Per Plate, rms) with Capacitor Input to Filter volts

OPERATION CHARACTERISTICS

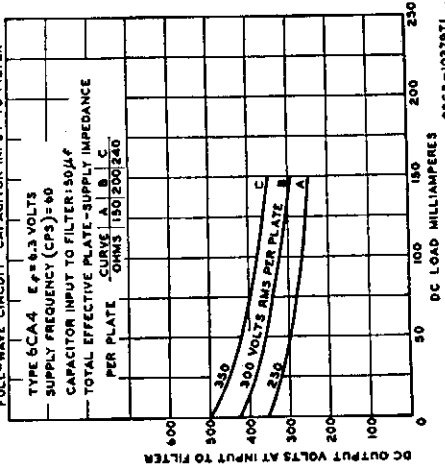

DC OUTPUT CURRENT ma
 HOT SWITCHING TRANSIENT PLATE CURRENT (Per Plate) ma
 PEAK HEATER-CATHODE VOLTAGE:
 Heater negative with respect to cathode volts
 Heater positive with respect to cathode volts
 Typical Operation with Capacitor Input to Filter:
 AC Plate-co-Plate Supply Voltage 600
 Filter-Input Capacitor 50
 Total Effective Plate Supply Impedance per Plate 50
 DC Output Voltage at Input to Filter (Approx.) 200
 For dc output current of 150 ma 245
 283
 † When capacitor-input circuits are used, a maximum peak current value per plate of 1 ampere during the initial cycles of the hot-switching transient should not be exceeded.

BEAM POWER TUBE

Miniature type used in af power output stage of radio and television receivers. Outline 7C, OUTLINES SECTION. Tube requires miniature seven-contact socket and may be operated in any position. Heater volts (ac/dc), 6.3; amperes, 1.2.

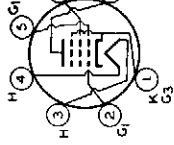

CLASS A₁ AMPLIFIER

Maximum Ratings, (Design-Center Values):

PLATE VOLTAGE volts
 GRID-NO.2 (SCREEN-GRID) VOLTAGE volts
 GRID-NO.1 (CONTROL-GRID) VOLTAGE, Positive-bias value volts
 PLATE DISSIPATION watts
 GRID-NO.2 INPUT watts
 PEAK HEATER-CATHODE VOLTAGE:
 Heater negative with respect to cathode volts
 Heater positive with respect to cathode volts
 BULB TEMPERATURE (At hottest point) °C

Typical Operation:

Plate Voltage 110
 Grid-No.2 Voltage 110
 Grid-No.1 (Control-Grid) Voltage -4
 Peak AF Grid-No.1 Voltage 4
 Zero-Signal Plate Current 32
 Maximum-Signal Plate Current 37
 Zero-Signal Grid-No.2 Current (Approx.) 31
 Maximum-Signal Grid-No.2 Current (Approx.) 3.5
 Plate Resistance (Approx.) 7.5
 Transconductance 16000
 Load Resistance 8100
 Total Harmonic Distortion 3500
 Maximum-Signal Power Output 5
 1.1

Maximum Circuit Values:

Grid-No.1-Circuit Resistance:
 For fixed-bias operation megohm
 For cathode-bias operation 0.5 max megohm

† The dc component must not exceed 160 volts.

BEAM POWER TUBE

Glass octal types used as horizontal deflection amplifiers in color television receivers. Type 6CB5-A, Outline 25A, OUTLINES SECTION. Type 6CB5 maximum dimensions: over-all length, 5-1/8 inches; seated height, 4-19/32 inches; diameter, 2-1/16 inches. Tubes require octal socket and may be mounted in any position. Type 6CB5 is a DISCONTINUED type listed for reference only.

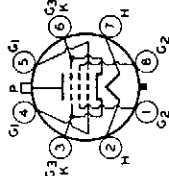

HEATER VOLTAGE (AC/DC) 6.3
 HEATER CURRENT amperes
 DIRECT INTERELECTRODE CAPACITANCES (Approx.):
 Grid No.1 to Plate 0.4 pf
 Grid No.1 to Cathode, Heater, Grid No.2, and Grid No.3 22 pf
 Plate to Cathode, Heater, Grid No.2, and Grid No.3 10 pf

6CA5

Related Types:
 12CA5, 25CA5

6CB5

6CB5A

TRANSCONDUCTANCE* 8800
 G-FACTOR, Grid No.2 to Grid No.1 3.8
 or plate and grid-No.2 volts, 175; grid-No.1 volts, -30; plate ma., 90; grid-No.2 ma., 6.

HORIZONTAL DEFLECTION AMPLIFIER

For operation in a 525-line, 50-frame system
 6CB5

Design-Center Values*

6CB5-A	Design-Maximum Values
DC PLATE VOLTAGE	380 max volts
PEAK POSITIVE-PULSE PLATE VOLTAGE [†]	6800 ^{max} volts
PEAK NEGATIVE-PULSE PLATE VOLTAGE	-1650 max volts
DC GRID-No.2 (SCREEN-GRID) VOLTAGE	220 max volts
DC GRID-No.1 (CONTROL-GRID) VOLTAGE	-55 max volts
PEAK NEGATIVE-PULSE GRID-No.1 VOLTAGE	-220 max volts
PEAK CATHODE CURRENT	850 max ma
AVERAGE CATHODE CURRENT	240 max ma
GRID-No.2 INPUT	4 max ma
HEATER DISSIPATION [‡]	26 max watts
HEATER-CATHODE VOLTAGE:	
Heater negative with respect to cathode	200 max volts
Heater positive with respect to cathode	200 ^{max} volts
TUBE TEMPERATURE (At hottest point)	220 max °C

Maximum Circuit Value:

Grid-No.1-Circuit Resistance 0.47 megohm
 Except as noted.
 The duration of the voltage pulse must not exceed 15 per cent of one horizontal scanning cycle. In a 15-line, 30-frame system, 15 per cent of one horizontal scanning cycle is 10 microseconds.
[†]Absolute-Maximum Value. Under no circumstances should this absolute value be exceeded.
[‡]An adequate bias resistor or other means is required to protect the tube in the absence of excitation.
 The dc component must not exceed 100 volts.

6CB6

6CB6A

Related types:
 3CB6, 4CB6

SHARP-CUTOFF PENTODE

Miniature types used in television receivers as intermediate-frequency amplifier at frequencies up to about 45 megacycles per second and as rf amplifier in vhf television tuners. Tubes

feature very high transconductance combined with low interelectrode capacitance values, and are provided with separate base pins for grid No.3 and the cathode to permit the use of an unbypassed cathode resistor to minimize the effects of regeneration. Type 6CB6-A has a controlled heater warm-up time for use in television receivers employing series-connected heater strings. Outline 7B, OUTLINES SECTION. Tubes require miniature seven-contact socket and may be mounted in any position. For typical operation as a resistance-coupled amplifier, refer to RESISTANCE-COUPLED AMPLIFIER SECTION.

HEATER VOLTS (AC/DC)	6.3	volts
HEATER CURRENT	0.3	ampere
HEATER WARM-UP TIME (Average) for 6CB6-A	11	seconds
Without External Shield	0.025 max	pf
With External Shield*	0.015 max	pf

Grid No.1 to Plate	6.5	pf
Grid No.1 to Cathode, Heater, Grid No.2, Grid No.3, Plate to Cathode, Heater, Grid No.2, Grid No.3, and Internal Shield	2	pf
With external shield connected to cathode.		

CLASS A₁ AMPLIFIER

(Design-Maximum Values):

DC PLATE VOLTAGE	330 max volts
PEAK POSITIVE-PULSE PLATE VOLTAGE, Positive value	See curve page 70
PEAK NEGATIVE-PULSE PLATE VOLTAGE	330 max volts
DC GRID-No.2 (SCREEN-GRID) VOLTAGE	0 max volts
DC GRID-No.1 (CONTROL-GRID) VOLTAGE, Positive-bias value	2.3 max volts
HEATER DISSIPATION	0.55 max watt
GRID-No.2 INPUT	See curve page 70
For grid-No.2 voltages up to 165 volts	
For grid-No.2 voltages between 165 and 330 volts	
PEAK HEATER-CATHODE VOLTAGE:	
Heater negative with respect to cathode	200 max volts
Heater positive with respect to cathode	200 ^{max} volts

Characteristics:

Plate Supply Voltage	125	volts
Grid No.3	Connected to cathode at socket	
Grid-No.2 Supply Voltage	125	volts
Cathode-Bias Resistor	56	ohms
Plate Resistance (Approx.)	0.28	megohm
Transconductance (Approx.)	8000	micromhos
Grid-No.1 Voltage (Approx.) for plate current of 20 ma	-8.5	volts
Grid-No.1 Voltage (Approx.) for plate current of 2.8 ma and cathode-bias resistor of 0 ohms	-3	volts
Plate Current	13	ma
Grid-No.2 Current	3.7	ma

*The dc component must not exceed 100 volts.

AVERAGE CHARACTERISTICS

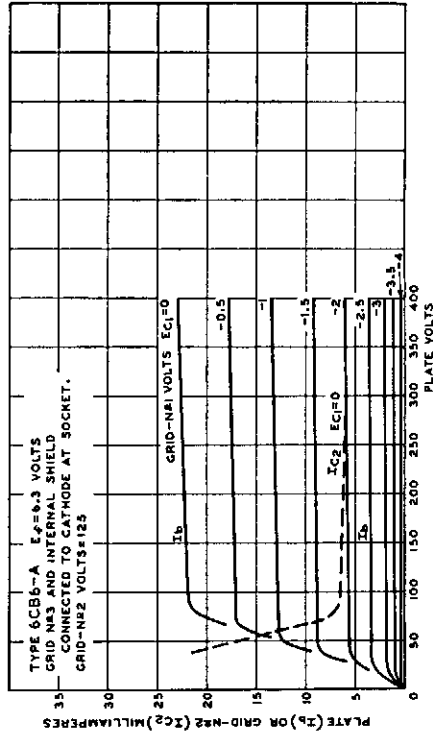

92CM-985-471

BEAM POWER TUBE

Glass octal types used as horizontal deflection amplifiers in high-efficiency deflection circuits of television receivers employing either transformer coupling or direct coupling to the deflection yoke. Type 6CD6-GA, Outline 25A, OUTLINES SECTION. Tubes require octal socket. Type 6CD6-GA may be supplied with pins 1, 4, and 6 omitted. Vertical tube mounting is preferred but horizontal operation is permissible if pins No.2 and 7 are in vertical plane. Type 6CD6-G has a maximum peak positive-pulse plate-voltage rating (Absolute Maximum) of 6600 volts, a maximum plate-dissipation rating of 15 watts, and a maximum bulb-temperature rating (at hottest point) of 210°C. Type 6CD6-G is a DISCONTINUED type listed for reference only.

6CD6G
6CD6GA

Related type:
 25CD6GS

HEATER VOLTAGE (AC/DC)	6.3	volts
HEATER CURRENT	2.5	ampere
Direct Interelectrode Capacitances (Approx.):		
Grid No.1 to Plate	1.1	pf
Grid No.1 to Cathode, Heater, Grid No.2, and Grid No.3	22	pf
Plate to Cathode, Heater, Grid No.2, and Grid No.3	8.5	pf
TRANSCONDUCTANCE*	7200	micromhos
PLATE RESISTANCE (Approx.) [†]	3.9	ohms
MU-FACTOR, Grid No.2 to Grid No.1 [‡]		
*For plate and grid-No.2 volts, 175; grid-No.1 volts, -30; plate ma., 75; grid-No.2 ma., 5.5.		

HORIZONTAL DEFLECTION AMPLIFIER

For operation in a 525-line, 50-frame system

Maximum Ratings, (Design-Center Values):

DC PLATE VOLTAGE	700 max volts
PEAK POSITIVE-PULSE PLATE VOLTAGE* (Absolute Maximum)	7000 ^{max} volts
PEAK NEGATIVE-PULSE PLATE VOLTAGE	-1500 max volts
DC GRID-No.2 (SCREEN-GRID) VOLTAGE	8.5 max volts
PEAK NEGATIVE-PULSE GRID-No.1 VOLTAGE	-300 max volts
PEAK CATHODE CURRENT	700 max ma
AVERAGE CATHODE CURRENT	200 max ma

PLATE DISSIPATION..... 20 maz watts
 GRID-NO.2 INPUT..... 3 maz watts
 PEAK HEATER-CATHODE VOLTAGE..... 200 maz volts
 Heater negative with respect to cathode..... 200-maz volts
 Heater positive with respect to cathode..... 225 maz volts
 SOLE TEMPERATURE (At hottest point).....

Maximum Circuit Value:
 Grid-No.1-Circuit Resistance..... 0.47 maz megohm
 For grid-resistor-bias operation.
 The duration of the voltage pulse must not exceed 15 per cent of one horizontal scanning cycle. In a 525-line, 30-frame system, 15 per cent of one horizontal scanning cycle is 10 microseconds.
 Under no circumstances should this absolute value be exceeded.
 An adequate bias resistor or other means is required to protect the tube in the absence of excitation.
 The dc component must not exceed 100 volts.

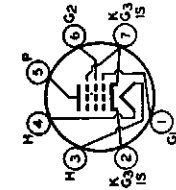
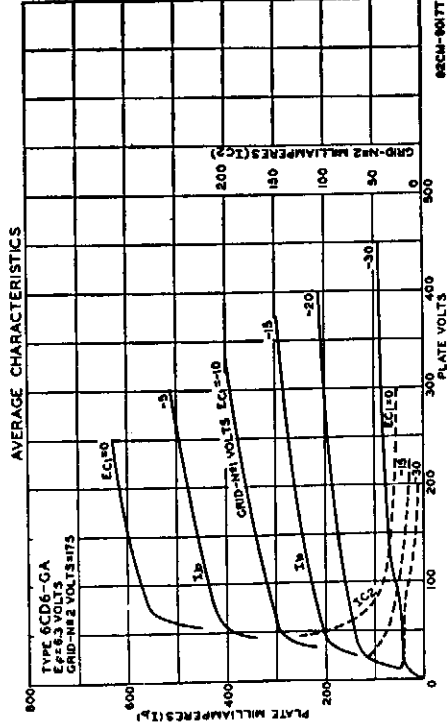
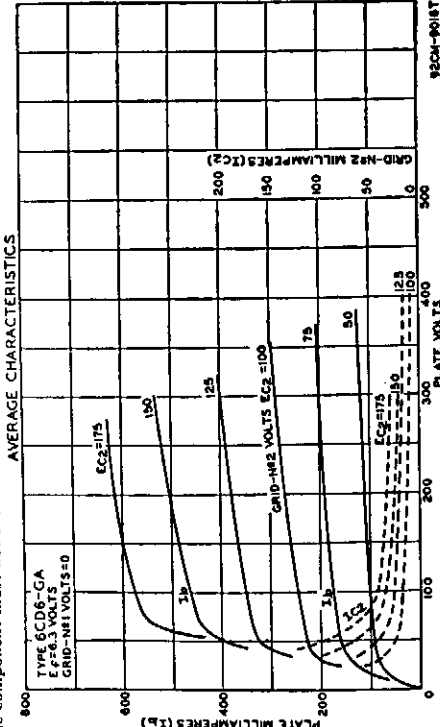

SHARP-CUTOFF PENTODE
 Miniature type used as rf and if amplifier in vhf television receivers employing series-connected heater strings. Outline 7B, OUTLINES SECTION. Tube requires miniature seven-contact socket and may be operated in any position.

6CE5
 Related type:
 3CE5

HEATER VOLTS (AC/DC)..... 6.3 volts
 HEATER CURRENT..... 0.3 ampere
 HEATER WARM-UP TIME (Average)..... 11 seconds
 DIRECT INTERELECTRODE CAPACITANCES:
 Grid No.1 to Plate..... 0.03 maz pf
 Grid No.3, and Internal Shield..... 6.5 pf
 Plate to Cathode, Heater, Grid No.2, Grid No.3, and Internal Shield..... 1.9 pf

CLASS A: AMPLIFIER

Maximum Ratings, (Design-Center Values):

PLATE VOLTAGE..... 300 maz volts
 GRID-NO.2 (SCREEN-GRID) VOLTAGE..... 150 maz volts
 GRID-NO.1 (CONTROL-GRID) VOLTAGE, Positive-bias value..... 0 maz volts
 GRID-NO.2 INPUT..... 0.5 maz watt
 PLATE DISSIPATION..... 2 maz watts
 PEAK HEATER-CATHODE VOLTAGE..... 200 maz volts
 Heater negative with respect to cathode..... 200-maz volts
 Heater positive with respect to cathode.....
 The dc component must not exceed 100 volts.

Characteristics:

Plate Voltage..... 125 volts
 Grid-No.2 Voltage..... 125 volts
 Grid-No.1 Supply Voltage..... 1 volt
 Grid-No.1 Resistor (By-passed)..... 1 megohm
 Plate Resistance (Approx.)..... 0.3 megohm
 Transconductance..... 7600 μ mbhos
 Grid-No.1 Voltage (Approx.) for plate current of 35 μ a..... 5 volts
 Plate Current..... 11 ma
 Grid-No.2 Current..... 2.3 ma

SHARP-CUTOFF PENTODE

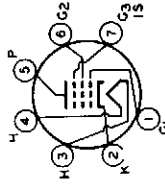

Miniature type used in television receivers as an intermediate-frequency amplifier at frequencies up to about 45 megacycles per second, and as an rf amplifier in vhf television tuners. Because of its plate-current cutoff characteristic, this type is used in gain-controlled stages of video if amplifiers. This type is electrically similar to miniature type 6CB6. Outline 7B, OUTLINES SECTION. Heater volts (ac/dc), 6.3; amperes, 0.3.

6CF6
 Related type:
 3CF6

Characteristics:

Plate Supply Voltage..... 125 volts
 Grid No.3..... Connected to cathode at socket
 Grid-No.2 Supply Voltage..... 125 volts
 Cathode-Bias Resistor..... 56 ohms
 Plate Resistance (Approx.)..... 0.3 megohm
 Transconductance..... 7800 μ mbhos
 Grid-No.1 Voltage (Approx.) for plate current of 20 μ a..... -6 volts
 Grid-No.1 Voltage (Approx.) for plate current of 2.2 ma and cathode-bias resistor of 0 ohms..... -3 volts
 Plate Current..... 12.5 ma
 Grid No.2 Current..... 3.7 ma

MEDIUM-MU TWIN TRIODE

Miniature type used as combined vertical deflection and horizontal deflection oscillator in television receivers. Also used as phase inverter, sync separator and amplifier, and resistance-coupled amplifier in radio receivers. This type has a controlled heater warm-up time for use in receivers employing series-connected heater strings. Except for the common heater, each triode unit is independent of the other. Outline 8D, OUTLINES SECTION. Tube requires miniature nine-contact socket and may be mounted in any position. For typical operation as a resistance-coupled amplifier, refer to RESISTANCE-COUPLED AMPLIFIER SECTION.

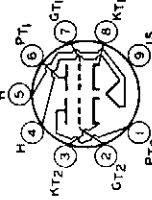

HEATER VOLTAGE (AC/DC)..... 6.3 volts
 HEATER CURRENT..... 0.6 ampere

HEATER WARM-UP TIME (Average).....	11	seconds
DIRECT INTERELECTRODE CAPACITANCES (Each Unit, Approx.):		
Grid to Plate.....	4.0	pf
Grid to Cathode, Heater, and Internal Shield.....	2.3	pf
Plate to Cathode, Heater, and Internal Shield.....	2.2	pf

CLASS A₁ AMPLIFIER (Each Unit)

Maximum Ratings, (Design-Maximum Values):		
PLATE VOLTAGE.....	330 max	volts
GRID VOLTAGE, Positive-bias value.....	0 max	volts
PLATE DISSIPATION:		
For either plate.....	4 max	watts
For both plates with both units operating.....	5.7 max	watts
CATHODE CURRENT.....	22 max	ma
PEAK HEATER-CATHODE VOLTAGE:		
Heater positive with respect to cathode.....	200 max	volts
Heater negative with respect to cathode.....	200 max	volts

Characteristics:

Plate Voltage.....	250	volts
Grid Voltage.....	0	volts
Amplification Factor.....	20	
Plate Resistance (Approx.).....	7700	ohms
Transconductance.....	2600	μmhos
Grid Voltage (Approx.) for plate current of 10 ma.....	-1	volts
Plate Current for grid voltage of -12.5 volts.....	1.3	ma
Plate Current.....	10	ma

Maximum Circuit Value:

Grid-Circuit Resistance:		
For fixed-bias operation.....	1.0 max	megohm
• The dc component must not exceed 100 volts.		

AVERAGE PLATE CHARACTERISTICS FOR EACH UNIT

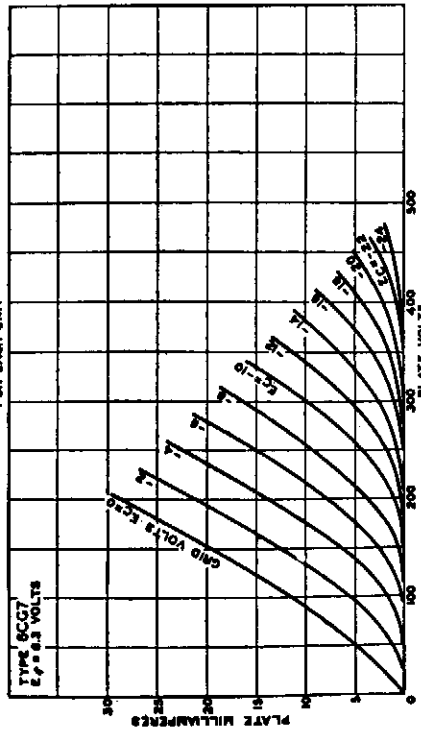

6CG8-6442T

OSCILLATOR

For operation in a 525-line, 30-frame system

Vertical Deflection Oscillator.....	330 max	volts
Horizontal Deflection Oscillator.....	-660 max	volts
PEAK NEGATIVE-PULSE GRID VOLTAGE.....	330 max	ma
PEAK CATHODE CURRENT.....	22 max	ma
PLATE DISSIPATION:		
For either plate.....	4 max	watts
For both plates with both units operating.....	5.7 max	watts
PEAK HEATER-CATHODE VOLTAGE:		
Heater positive with respect to cathode.....	200 max	volts
Heater negative with respect to cathode.....	200 max	volts
Maximum Circuit Value:		
Grid-Circuit Resistance.....	2.2 max	megohms
• The dc component must not exceed 100 volts.		

MEDIUM-MU TRIODE—SHARP-CUTOFF PENTODE

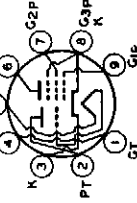

Miniature types used as combined oscillator and mixer tubes in television receivers utilizing an intermediate frequency in the order of 40 megacycles per second. When used in an AM/FM

receiver, the triode unit is used as an oscillator for both sections. In the AM section, the pentode unit is used as a high-gain, pentode mixer; in the FM section, the pentode unit is used either as a pentode mixer or as a triode-connected mixer depending on signal-to-noise considerations. Type 6CG8-A has a controlled heater warm-up time for use in television receivers employing series-connected heater strings. Outline 8B, OUTLINES SECTION. Tubes require miniature nine-contact socket and may be mounted in any position. Heater volts (ac/dc), 6.3; amperes, 0.45; warm-up time (average) for 6CG8-A, 11 seconds. Maximum ratings, characteristics, and typical operating values are the same as those of miniature type 6X8. For curves of average characteristics, see type 6X8. The 6CG8 is a DISCONTINUED type listed for reference only.

DIRECT INTERELECTRODE CAPACITANCES:

Triode Unit:		
Grid to Plate.....	1.5	Without External Shield
Grid to Cathode, Heater, and Pentode Grid No. 3.....	2.4	With External Shield
Plate to Cathode, Heater, and Pentode Grid No. 3.....	1	
Pentode Unit:		
Grid No.1 to Plate.....	0.04 max	
Grid No.1 to Cathode, Heater, Grid No.2, and Grid No.3.....	4.6	
Grid No.2 to Cathode, Heater, Grid No.2, and Grid No.3.....	0.9	
Pentode Grid No.1 to Triode Plate.....	0.05 max	
Pentode Plate to Triode Plate.....	0.05 max	
Heater to Cathode.....	6.5	

• With external shield connected to cathode, except as noted.

MEDIUM-MU TRIODE—SHARP-CUTOFF PENTODE

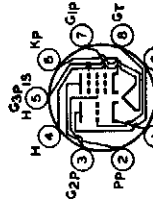

Miniature type used in a wide variety of applications in television receivers. The pentode unit is used as an if amplifier, video amplifier, agc amplifier, or reactance tube. The triode

unit is used in low-frequency oscillator, sync-separator, sync-clipper, and phase splitter circuits. Outline 8B, OUTLINES SECTION. Tube requires miniature nine-contact socket and may be mounted in any position. For curves of average plate characteristics, refer to type 6AN8. The pentode-unit curve for the 6AN8 applies for this type except that grid No.3, heater, and internal shield (pin 5) are connected to ground.

Without External Shield

Grid No.1 to Plate.....	0.02 max
Grid No.1 to Cathode, Heater, Grid No.2, and Grid No.3.....	4.6
Grid No.2 to Cathode, Heater, Grid No.2, and Grid No.3.....	1.6
Pentode Grid No.1 to Triode Plate.....	0.14 max
Pentode Plate to Triode Plate.....	0.008 max
Heater to Cathode.....	6.5

With External Shield

Grid No.1 to Plate.....	0.02 max
Grid No.1 to Cathode, Heater, Grid No.2, and Grid No.3.....	4.6
Grid No.2 to Cathode, Heater, Grid No.2, and Grid No.3.....	1.6
Pentode Grid No.1 to Triode Plate.....	0.14 max
Pentode Plate to Triode Plate.....	0.008 max
Heater to Cathode.....	6.5

6CH8

HEATER VOLTAGE (AC/DC).....	6.3	volts
HEATER CURRENT.....	0.45	ampere
DIRECT INTERELECTRODE CAPACITANCES:		
Triode Unit:		
Grid to Plate.....	1.6	pf
Grid to Cathode, Heater, Pentode Grid No.3, and Internal Shield.....	1.9	pf
Plate to Cathode, Heater, Pentode Grid No.3, and Internal Shield.....	1.6	pf
Pentode Unit:		
Grid No.1 to Plate.....	0.025	pf
Grid No.1 to Cathode, Heater, Grid No.2, Grid No.3, and Internal Shield.....	7	pf
Grid No.2 to Cathode, Heater, Grid No.2, Grid No.3, and Internal Shield.....	2.25	pf
Triode Grid No.1 to Triode Plate.....	0.005	pf
Pentode Grid No.1 to Triode Plate.....	0.02	pf
Pentode Plate to Triode Plate.....	0.04	pf

CLASS A₁ AMPLIFIER

Maximum Ratings, (Design-Center Values):

PLATE VOLTAGE	300 maz	Penode Unit	300 maz
GRID-NO.3 (SUPPRESSOR-GRID) VOLTAGE, Positive value.	0 maz		
GRID-NO.2 SUPPLY VOLTAGE	300 maz		
GRID-NO.2 SCREEN-GRID VOLTAGE	0 maz		
GRID-NO.1 (CONTROL-GRID) VOLTAGE, Positive-bias value.	0 maz		
PLATE DISSIPATION	2.6 maz		
GRID-NO.2 INPUT	0.5 maz		
For grid-No.2 voltages up to 150 volts			
For grid-No.2 voltages between 150 and 300 volts			
PEAK HEATER-CATHODE VOLTAGE	200 maz		
Heater negative with respect to cathode	200 ^o maz		
Heater positive with respect to cathode			

Characteristics:

Plate Supply Voltage	200	Connected to ground at socket
Grid No.3	150	
Grid-No.2 Supply Voltage	-6	
Grid Voltage	19	
Cathode-Bias Resistor	5750	ohms
Amplification Factor	3300	ohms
Plate Resistance (Approx.)	-19	ohms
Transconductance	13	μmhos
Grid-No.1 Voltage (Approx.) for plate current of 10μa	2.8	ma
Plate Current		
Grid-No.2 Current		

Maximum Circuit Values:

Grid-No.1-Circuit Resistance,*	0.5 maz	megohm
For fixed-bias operation	1.0 maz	megohm
For cathode bias operation		

* The dc component must not exceed 100 volts.

* The heater-cathode voltage should not exceed the value of the operating cathode bias because the voltage between the heater and cathode is also applied between the cathode and grid No.3. The net result is to make grid No.3 negative with respect to cathode with possible change in tube characteristics. * If either unit is operating at maximum rated conditions, grid No.1-circuit resistance for both units should not exceed the stated values.

LOW-MU TRIODE

Class octal type used as a vertical-deflection-amplifier tube in television receivers. Outline 14E, OUTLINES SECTION. Tube requires octal socket. Heater volts (ac/dc), 6.3; amperes, 1.25. Characteristics as class A₁ amplifier: plate volts, 250; grid volts, -28; plate ma, 40; amplification factor, 6.6; plate resistance (approx.), 1200 ohms; transconductance, 5500 μmhos. Maximum ratings as vertical deflection amplifier (for operation in a 525-line, 30-frame system): dc plate volts, 550 maz; peak positive-pulse plate ma., 100 maz; peak negative-pulse grid volts, 250 maz; peak cathode ma., 350 maz; average cathode ma., 100 maz; plate dissipation, 12 maz watts; peak heater-cathode volts, 200 maz; (the dc component must not exceed 100 volts). This type is used principally for renewal purposes.

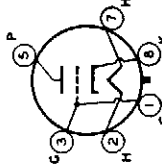

6CK4

POWER PENTODE

Miniature type used in output stage of video amplifier of television receivers and as wide-band amplifier tube in industrial and laboratory equipment. Outline 8D, OUTLINES SECTION. Tube requires miniature nine-contact socket and may be mounted in any position.

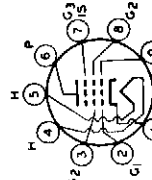

6CL6

Heater Voltage (AC/DC) 6.3 volts
 Heater Current 0.65 ampere
 Direct Inter-Electrode Capacitances (Approx.):
 Grid No.1 to Plate 0.12 pf
 Grid No.1 to Cathode, Heater, Grid No.2, Grid No.3, and Internal Shield 11 pf
 Plate to Cathode, Heater, Grid No.2, Grid No.3, and Internal Shield 5.5 pf

CLASS A₁ AMPLIFIER

Maximum Ratings, (Design-Center Values):		
PLATE VOLTAGE	300 maz	volts

GRID-NO.3 (SUPPRESSOR-GRID) VOLTAGE, Positive Value	0 maz	volts
GRID-NO.2 (SCREEN-GRID) SUPPLY VOLTAGE	300 maz	volts
GRID-NO.2 VOLTAGE	150 maz	volts
GRID-NO.1 (CONTROL-GRID) VOLTAGE:		
Positive-bias value	-50 maz	volts
Negative-bias value	0 maz	volts
Positive-bias value	7.5 maz	watts
Negative-bias value	1.7 maz	watts
PLATE DISSIPATION		
Heater negative with respect to cathode	100 maz	volts
Heater positive with respect to cathode	100 maz	volts
Heater negative with respect to cathode	200 maz	volts
Heater positive with respect to cathode	200 maz	volts
BUJA TEMPERATURE (At hottest point)		°C

Typical Operation:

Plate Voltage	250	volts
Grid No.3 and Internal Shield	Connected to cathode at socket	
Grid-No.2 Voltage	150	volts
Grid-No.1 Voltage	-3	volts
Peak AF Grid-No.1 Voltage	3	volts
Zero-Signal Plate Current	30	ma
Maximum-Signal Plate Current	31	ma
Zero-Signal Grid-No.2 Current	7	ma
Maximum-Signal Grid-No.2 Current	7.2	ma
Plate Resistance (Approx.)	0.09	megohm
Transconductance	11000	μmhos
Grid-No.1 Voltage (Approx.) for plate current of 10 μa	-14	volts
Load Resistance	7500	ohms
Total Harmonic Distortion	8	per cent
Maximum-Signal Power Output	2.8	watts

Typical Operation in 4-Mc-Bandwidth Video Amplifier:

Plate Supply Voltage	300	volts
Grid No.3 and Internal Shield	Connected to cathode at socket	
Grid-No.2 Supply Voltage	300	volts
Grid-No.1 Bias Voltage	-2	volts
Grid-No.1 Signal Voltage (Peak to Peak)	3	volts
Grid-No.2 Resistor	24000	ohms
Grid-No.1 Resistor	0.1	megohm
Load Resistance	3900	ohms
Zero-Signal Plate Current	30	ma
Zero-Signal Grid-No.2 Current	7.0	ma
Voltage Output (Peak to Peak)	132	volts

Maximum Circuit Values:

Grid-No.1 Circuit Resistance:		
For fixed-bias operation	0.1 maz	megohm
For cathode-bias operation	0.5 maz	megohm

AVERAGE CHARACTERISTICS

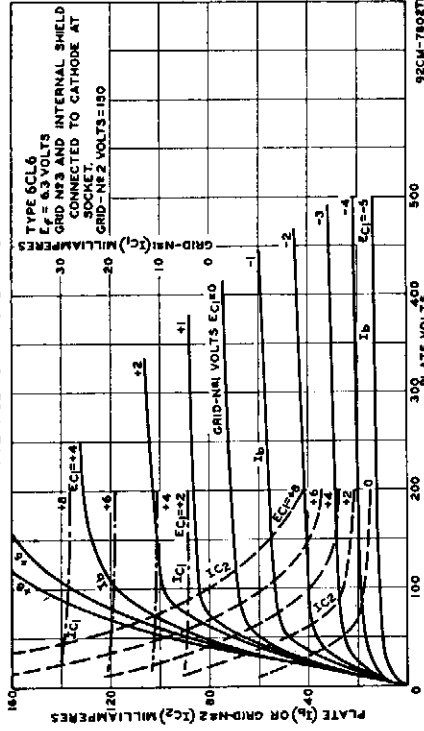

MEDIUM-MU TRIODE—
SHARP-CUTOFF TETRODE

Miniature types used as combined vhf oscillator and mixer in television receivers employing series-connected heater strings. Outline 8B, OUTLINES SECTION. Tubes require miniature

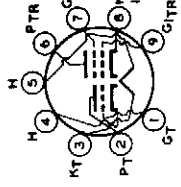

6CL8

6CL8A

Related types:
5CL8A, 19CL8A

For cathode-bias operation 2.2 maz megohms
 For grid-resistor-bias operation 2.2 maz megohms
 ‡ The duration of the voltage pulse must not exceed 15 per cent of one vertical scanning cycle. In a 525-line, 30-frame system, 15 per cent of one vertical scanning cycle is 2.5 milliseconds.
 * The dc component must not exceed 100 volts.

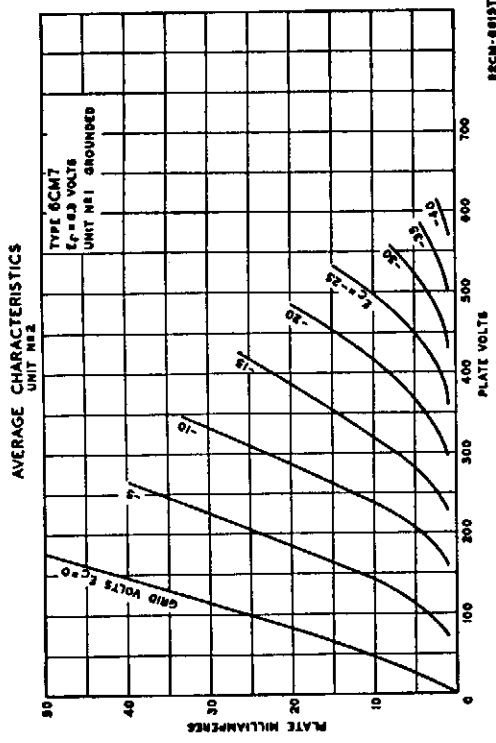

HIGH-MU TRIODE—SHARP-CUTOFF PENTODE

6CM8
 Related type: 5CM8
 Miniature type used in variety of applications in television receivers. The pentode unit is used as an intermediate-frequency-amplifier, a video-amplifier, an agc-amplifier, or as a reactance tube. The triode unit is used in sweep-oscillator, sync-separator, sync-clipper, and phase-splitter circuits. Outline 8B, OUTLINES SECTION. Tube requires miniature nine-contact socket and may be mounted in any position. Heater volts (ac/dc), 6.3; amperes, 0.45; warm-up time (average), 11 seconds.

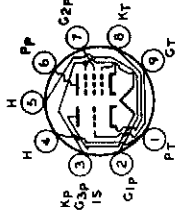

CLASS A₁ AMPLIFIER

Maximum Ratings, (Design-Center Values):	Triode Unit	Pentode Unit
PLATE VOLTAGE.....	300 maz	300 maz
GRID-NO.2 (SCREEN-GRID) SUPPLY VOLTAGE.....	0 maz	See curve page 70
GRID-NO.2 VOLTAGE.....	1 maz	2 maz
PLATE DISSIPATION.....	—	0.5 maz watt
GRID-NO.2 INPUT.....	—	See curve page 70
For grid-No.2 voltages up to 150 volts. For grid-No.2 voltages between 150 and 300 volts. PEAK HEATER-CATHODE VOLTAGE: Heater negative with respect to cathode. Heater positive with respect to cathode.	200 maz 200 ^m maz	200 maz 200 ^m maz
Characteristics:		
Plate Supply Voltage.....	250	250
Grid-No.2 Supply Voltage.....	—	150
Cathode-Bias Resistor.....	—	180
Amplification Factor.....	100	—
Plate Resistance (Approx.).....	0.05	—
Transconductance.....	2000	—
Grid-No.1 Voltage (Approx.) for plate current of 10 μ a.....	—	6200
Plate Current.....	1.8	9.5
Grid-No.2 Current.....	—	2.8

Maximum Circuit Values:
 Grid-No.1-Circuit Resistance:
 For fixed-bias operation..... 0.25 maz
 For cathode-bias operation..... 1 maz
 * The dc component must not exceed 100 volts.

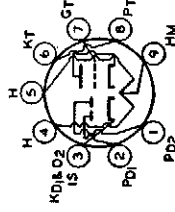

TWIN-DIODE—HIGH-MU TRIODE

Miniature type used as combined horizontal phase detector and reactance tube in television receivers employing series-connected heater strings. The triode unit is used in sync-separator, sync-amplifier, or audio amplifier circuits. Outline 8B, OUTLINES SECTION. Tube requires miniature nine-contact socket and may be mounted in any position. For typical operation of triode unit as resistance-coupled amplifier, refer to RESISTANCE-COUPLED AMPLIFIER SECTION. For curve of average plate characteristics for triode unit, refer to type 6T8-A. Heater volts (ac/dc), 6.3 (series), 3.15 (parallel); amperes, 0.3 (series), 0.6 (parallel); warm-up time (average), 11 seconds.

6CN7
 Related type: 8CN7

TRIODE UNIT AS CLASS A₁ AMPLIFIER

Maximum Ratings, (Design-Maximum Values):	
PLATE VOLTAGE.....	330 maz volts
GRID VOLTAGE, Positive-bias value.....	0 maz volts
PLATE DISSIPATION.....	1.1 maz watt
PEAK HEATER-CATHODE VOLTAGE: Heater negative with respect to cathode. Heater positive with respect to cathode.	200 maz volts 200 ^m maz volts

Characteristics:

Plate Voltage.....	100
Grid Voltage.....	-1
Amplification Factor.....	70
Plate Resistance (Approx.).....	54000
Transconductance.....	1300
Plate Current.....	0.8
DIODE UNITS	
Maximum Ratings, (Design-Maximum Values):	
PLATE CURRENT (Each Unit).....	5.5 maz
PEAK HEATER-CATHODE VOLTAGE: Heater negative with respect to cathode. Heater positive with respect to cathode.	200 maz volts 200 ^m maz volts
* The dc component must not exceed 100 volts.	

HALF-WAVE VACUUM RECTIFIER

Octal type used as damper tube in horizontal-deflection circuits of television receivers. Outline 14F, OUTLINES SECTION. Tube requires octal socket and may be mounted in any position. Socket terminals 1, 2, 4, and 6 should not be used as tie points. It is especially important that this tube, like other power-handling tubes, be adequately ventilated. Heater volts (ac/dc), 6.3; amperes, 1.6.

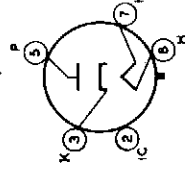

DAMPER SERVICE

For operation in a 525-line, 30-frame system

Maximum Ratings, (Design-Maximum Values):	
PEAK INVERSE PLATE CURRENT.....	5500 maz
PEAK PLATE CURRENT.....	1200 maz
DC PLATE CURRENT.....	190 maz
PLATE DISSIPATION.....	6.5 maz watts
PEAK HEATER-CATHODE VOLTAGE: Heater negative with respect to cathode. Heater positive with respect to cathode.	6500 ^m maz volts 3000 ^m maz volts

Triode Unit Pentode Unit
 0.25 maz 0.25 maz
 1 maz 1 maz
 megohm megohm

6CQ4

Characteristics, Instantaneous Value:

Tube Voltage Drop for plate current of 250 ma 25 volts
 * The duration of the voltage pulse must not exceed 15 per cent of one horizontal scanning cycle. In a 525-line, 30-frame system, 15 per cent of one horizontal scanning cycle is 10 microseconds.
 * The dc component must not exceed 900 volts.
 * The dc component must not exceed 100 volts.

MEDIUM-MU TRIODE—SHARP-CUTOFF TETRODE

Miniature type used in a wide variety of applications in color and black-and-white television receivers employing series-connected heater strings. Especially useful as combined vhf oscillator and mixer in tuners of television receivers utilizing an intermediate frequency in the order of 40 megacycles per second. The tetrode unit is used as a mixer, video if amplifier, or sound if amplifier tube. The triode unit is used in vhf oscillator, phase-splitter, sync-clipper, and rf amplifier circuits. Outline 8B, OUTLINES SECTION. Tube requires miniature nine-contact socket and may be mounted in any position.

6CQ8

Related types: 5C8A

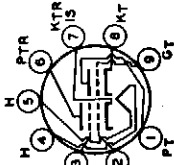

vhf oscillator and mixer in tuners of television receivers utilizing an intermediate frequency in the order of 40 megacycles per second. The tetrode unit is used as a mixer, video if amplifier, or sound if amplifier tube. The triode unit is used in vhf oscillator, phase-splitter, sync-clipper, and rf amplifier circuits. Outline 8B, OUTLINES SECTION. Tube requires miniature nine-contact socket and may be mounted in any position.

HEATER VOLTAGE (ac/dc).....	6.3	volts
HEATER CURRENT.....	0.45	ampere
HEATER WARM-UP TIME (Average).....	11	seconds
..... Without Shield.....	1.8	pf
..... External Shield*.....	2.7	pf
.....	4.4	pf
Triode Unit.....	0.019 maz	pf
Grid No.1 to Plate.....	5.0	pf
Grid No.1 to Cathode, Heater, Grid No.2 and Internal Shield.....	2.5	pf
Plate to Cathode, Heater, Grid No.2, and Internal Shield.....	0.07 maz	pf
Tetrode Plate to Triode Plate.....	3.0†	pf
Heater to Cathode (Each Unit).....		

† With external shield connected to cathode of unit under test.
 † With external shield connected to ground.

CLASS A₁ AMPLIFIER

Maximum Ratings, (Design-Maximum Values):	Triode Unit	Tetrode Unit
PLATE VOLTAGE.....	330 maz	330 maz
GRID-NO.2 (SCREEN-GRID) SUPPLY VOLTAGE.....	—	—
GRID-NO.2 VOLTAGE.....	0 maz	0 maz
GRID-NO.1 (CONTROL-GRID) VOLTAGE, Positive-bias value.....	3.1 maz	3.1 maz
PLATE DISSIPATION.....	—	—
GRID-NO.2 INPUT.....	—	—
For grid-No.2 voltages up to 165 volts.....	0.55 maz	0.55 maz
For grid-No.2 voltages between 165 and 330 volts.....	200 maz	200 maz
PEAK HEATER-CATHODE VOLTAGE: Heater negative with respect to cathode.....	200 ^a maz	200 ^a maz
Heater positive with respect to cathode.....	—	—

Characteristics:		
Plate-Supply Voltage.....	125	volts
Grid-No.2 Supply Voltage.....	125	volts
Grid-No.1 Voltage.....	—	volts
Cathode-Bias Resistor.....	56	ohms
Amplification Factor.....	40	ohms
Plate Resistance (Approx.).....	5000	ohms
Transconductance.....	8000	μmhos
Grid-No.1 Voltage (Approx.) for plate current of 100 μa.....	—	volts
Plate Current.....	15	ma
Grid-No.2 Current.....	4.2	ma

Maximum Circuit Values:
 Grid-No.1-Circuit Resistance: For fixed-bias operation..... 0.5 maz
 For cathode-bias operation..... 1.0 maz
 * The dc component must not exceed 100 volts.

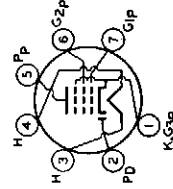

DIODE—REMOTE-CUTOFF PENTODE

Miniature type used as combined detector and audio amplifier in auto-mobile and ac-operated radio receivers. The diode unit is used as an AM detector, and the pentode unit as an automatic-volume-controlled audio amplifier. Outline 7B, OUTLINES SECTION. Tube requires miniature seven-contact socket and may be mounted in any position. Heater volts (ac/dc), 6.3; amperes, 0.3.

6CR6

Related types: 12CR6

PENTODE UNIT AS CLASS A₁ AMPLIFIER

Maximum Ratings, (Design-Center Values):		
PLATE VOLTAGE.....	300 maz	volts
GRID-NO.2 (SCREEN-GRID) VOLTAGE.....	See curve page 70	volts
GRID-NO.2 SUPPLY VOLTAGE.....	300 maz	volts
GRID-NO.1 (CONTROL-GRID) VOLTAGE, Positive-bias value.....	0 maz	volts
PLATE DISSIPATION.....	2.5 maz	watts
GRID-NO.2 INPUT.....	0.3 maz	watt
For grid-No.2 voltages up to 150 volts.....	See curve page 70	volts
For grid-No.2 voltages between 150 and 300 volts.....	100 maz	volts
PEAK HEATER-CATHODE VOLTAGE: Heater negative with respect to cathode.....	100 maz	volts
Heater positive with respect to cathode.....	100 maz	volts
Characteristics:		
Plate Voltage.....	250	volts
Grid-No.2 Voltage.....	100	volts
Grid-No.1 Voltage.....	—2	volts
Plate Resistance (Approx.).....	0.8	megohm
Transconductance.....	2200	μmhos
Plate Current.....	9.6	ma
Grid-No.2 Current.....	2.6	ma
Grid-No.1 Voltage (Approx.) for transconductance of 10 μmhos.....	—32	volts
Maximum Circuit Values:		
Grid-No.1-Circuit Resistance: For fixed-bias operation.....	0.25 maz	megohm
For cathode-bias operation.....	1.0 maz	megohm

DIODE UNIT

Maximum Rating, (Design-Center Value):	
PLATE CURRENT.....	1 maz

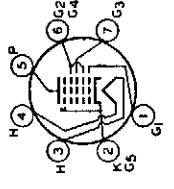

PENTAGRID AMPLIFIER

Miniature type used as a gated amplifier in television receivers. In such service, it may be used as a combined sync separator and sync clipper. Outline 7B, OUTLINES SECTION. Tube requires miniature seven-contact socket and may be mounted in any position. Heater volts (ac/dc), 6.3; amperes, 0.3.

6CS6

Related types: 3CS6, 4CS6

CLASS A₁ AMPLIFIER

Characteristics:		
Plate Voltage.....	100	volts
Grids-No.2-and-No.4 Voltage.....	30	volts
Grid-No.3 Voltage.....	—1	volts
Grid-No.1 Voltage.....	0.7	volt
Plate Resistance (Approx.).....	1500	megohm
Grid-No.3-to-Plate Transconductance.....	—	μmhos
Plate Current.....	0.8	ma
Grids-No.2-and-No.4 Current.....	5.5	ma
Grid-No.3 Voltage (Approx.) for plate current of 50 μa.....	—2.2	volts
Grid-No.1 Voltage (Approx.) for plate current of 50 μa.....	—	volts

GATED AMPLIFIER SERVICE

Maximum Ratings, (Design-Center Values):		
PLATE VOLTAGE.....	300 maz	volts
GRIDS-NO.2-AND-NO.4 SUPPLY VOLTAGE.....	300 maz	volts
GRIDS-NO.2-AND-NO.4 VOLTAGE.....	See curve page 70	volts
PLATE DISSIPATION.....	1 maz	watt
GRIDS-NO.2-AND-NO.4 INPUT: For grids-No.2-and-No.4 voltages up to 150 volts.....	1 maz	watt
For grids-No.2-and-No.4 voltages between 150 and 300 volts.....	See curve page 70	watt
CATHODE CURRENT.....	14 maz	ma

PEAK HEATER-CATHODE VOLTAGE:
Heater negative with respect to cathode.
Heater positive with respect to cathode.

Maximum Circuit Values:
Grid-No.1-Circuit Resistance megohm
Grid-No.3-Circuit Resistance megohms
*The dc component must not exceed 100 volts.

MEDIUM-MU DUAL TRIODE

Miniature type used as combined vertical deflection oscillator and vertical deflection amplifier in television receivers employing series-connected heater strings. Unit No.1 is used as a conventional blocking oscillator in vertical deflection circuits, and unit No.2 as a vertical deflection amplifier. Outline 8D, OUTLINES SECTION. Tube requires miniature nine-contact socket and may be mounted in any position. Heater volts (ac/dc), 6.3; amperes, 0.6; warm-up time (average), 11 seconds.

6CS7

Related types:
8CS7

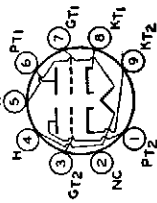

CLASS A₁ AMPLIFIER

Characteristics:	Unit No. 1	Unit No. 2
Plate Voltage.....	250	250
Grid Voltage.....	-8.5	-10.5
Amplification Factor.....	17	15.5
Plate Resistance (Approx.).....	7700	3450
Transconductance.....	2200	4500
Grid Voltage (Approx.) for plate current of 10 μ a.....	-24	-22
Grid Voltage (Approx.) for plate current of 60 μ a.....	10.5	19
Plate Current for grid voltage of -16 volts.....	-	3

VERTICAL DEFLECTION OSCILLATOR AND AMPLIFIER

For operation in a 525-line, 30-frame system

Maximum Ratings, (Design-Center Values):	Unit No. 1	Unit No. 2
DC PLATE VOLTAGE.....	500 maz	500 maz
PEAK POSITIVE-PULSE PLATE VOLTAGE (Absolute Maximum).....	-400 maz	2500 maz
PEAK NEGATIVE-PULSE GRID VOLTAGE.....	70 maz	105 maz
PEAK CATHODE CURRENT.....	20 maz	30 maz
AVERAGE CATHODE CURRENT.....	1.25 maz	6.5 maz
PLATE DISSIPATION.....	200 maz	200 maz
PEAK HEATER-CATHODE VOLTAGE: Heater negative with respect to cathode.....	200 maz	200 maz
Heater positive with respect to cathode.....	200 maz	200 maz

Maximum Circuit Values:

Grid-Circuit Resistance..... 2.2 maz
The duration of the voltage pulse must not exceed 15 per cent of one vertical scanning cycle. In a 525-line, 30-frame system, 15 per cent of one vertical scanning cycle is 2.5 milliseconds.
* Under no circumstances should this absolute value be exceeded.
* The dc component must not exceed 100 volts.

BEAM POWER TUBE

Miniature type used in the audio output stage of television receivers. Outline 7C, OUTLINES SECTION. Tube requires miniature seven-contact socket and may be mounted in any position.

6CU5

Related types:
12CU5/17CU5, 17CU5

HEATER VOLTAGE (AC/DC).....	6.3	volts
HEATER CURRENT.....	1.2	amperes
DIRECT INTERELECTRODE CAPACITANCES (Approx.):		
Grid No.1 to Plate.....	0.6	pf
Grid No.1 to Cathode, Heater, Grid No.2, and Grid No.3.....	13	pf
Plate to Cathode, Heater, Grid No.2, and Grid No.3.....	8.5	pf

CLASS A₁ AMPLIFIER

Maximum Ratings, (Design-Maximum Values):
PLATE VOLTAGE..... 150 maz

GRID-NO.2 (SCREENS-GRID) VOLTAGE..... 130 maz
GRID-NO.1 (CONTROL-GRID) VOLTAGE, Positive-bias value..... 0 maz
PLATE DISSIPATION..... 7 maz
GRID-NO.2 INPUT..... 1.4 maz
PEAK HEATER-CATHODE VOLTAGE:
Heater negative with respect to cathode..... 200 maz
Heater positive with respect to cathode..... 200 maz
BULB TEMPERATURE (At hottest point)..... 220 maz
*The dc component must not exceed 100 volts.

Typical Operation:

Plate Voltage..... 120 volts
Grid-No.2 Voltage..... 110 volts
Grid-No.1 Voltage..... -8 volts
Peak AF Grid-No.1 Voltage..... 8 volts
Zero-Signal Plate Current..... 49 ma
Maximum-Signal Plate Current..... 50 ma
Zero-Signal Grid-No.2 Current..... 4 ma
Maximum-Signal Grid-No.2 Current..... 8.5 ma
Plate Resistance (Approx.)..... 10000 ohms
Load Resistance..... 7500 ohms
Total Harmonic Distortion..... 2500 ohms
Maximum-Signal Power Output..... 10 watts
2.3

Maximum Circuit Values:

Grid-No.1-Circuit Resistance:
For fixed-bias operation..... 0.1 maz
For cathode-bias operation..... 0.5 maz

6CU6

Refer to type 6BQ6GTB/6CU6

MEDIUM-MU TRIODE—SHARP-CUTOFF PENTODE



Miniature type used in a wide variety of applications in color and black-and-white television receivers employing series-connected heater strings. The pentode unit is used as an amplifier, a video amplifier, an agc amplifier, and a reactance tube. The triode unit is used in low-frequency oscillator, sync-separator, sync-clipper, and phase-splitter circuits. Outline 8B, OUTLINES SECTION. Tube requires miniature nine-contact socket and may be mounted in any position. For curves of plate characteristics for pentode unit, refer to type 6AN8.

HEATER VOLTAGE (AC/DC)..... 6.3 volts
HEATER CURRENT..... 0.45 ampere
DIRECT INTERELECTRODE CAPACITANCES:
Triode Unit..... 11 seconds
Grid to Plate..... 1.6 pf
Grid to Cathode, Heater, Pentode Grid No.3, and Internal Shield..... 1.9 pf
Plate to Cathode, Heater, Pentode Grid No.3, and Internal Shield..... 1.6 pf

Pentode Unit:
Grid No.1 to Plate..... 0.025 maz
Grid No.1 to Cathode, Heater, Grid No.2, Grid No.3, Triode Cathode, and Internal Shield..... 7 pf
Plate to Cathode, Heater, Grid No.2, Grid No.3, Triode Cathode, and Internal Shield..... 2.4 pf
Pentode Grid No.1 to Triode Plate..... 0.03 maz
Pentode Plate to Triode Plate..... 0.07 maz

CLASS A₁ AMPLIFIER

Maximum Ratings, (Design-Maximum Values):

PLATE VOLTAGE.....	330 maz	Triode Unit	330 maz	Pentode Unit	330 maz
GRID-NO.2 SUPPLY VOLTAGE.....	-		-		See curve page 70
GRID-NO.2 (SCREEN-GRID) VOLTAGE, Positive-bias value.....	0 maz		0 maz		0.5 maz
PLATE DISSIPATION.....	2.8 maz		2.8 maz		2.3 maz
GRID-NO.2 INPUT: For grid-No.2 voltages up to 165 volts.....	-		-		0.55 maz
For grid-No.2 voltages between 165 and 330 volts.....	-		-		See curve page 70
PEAK HEATER-CATHODE VOLTAGE: Heater negative with respect to cathode.....	200 maz		200 maz		200 maz
Heater positive with respect to cathode.....	200 maz		200 maz		200 maz

Characteristics and Typical Operation:

Plate Supply Voltage.....	110	70
Grid Supply Voltage.....	0	0
Grid-No.2 Supply Voltage.....	180	0
Cathode-Bias Resistor.....	—	47000
Grid Resistor.....	65	68
Amplification Factor.....	6600	5440
Plate Resistance (Approx.).....	9800	12500
Transconductance.....	-4	—
Grid Voltage (Approx.) for plate current of 10 μ a.....	7	7.2
Plate Current.....	—	—

Maximum Circuit Values:
 Grid-Circuit Resistance: 0.5 maz megohm
 For fixed-bias operation: 2.2 maz megohm
 For cathode-bias operation: 2.2 maz megohm
 A plate supply voltage of 300 volts may be used provided that a sufficiently large resistor is used in the plate circuit to limit the plate dissipation to 1.5 watts under any condition of operation.
 For operation at metal-shell temperatures up to 135°C.

MEDIUM-MU TRIODE—SHARP-CUTOFF PENTODE
 Miniature type used in television receiver applications. Pentode unit is used as video amplifier; triode unit is used in sound intermediate-frequency amplifier, sweep-oscillator, sync-separator, sync-amplifier, and sync-clipper circuits. Outline 8D, OUTLINES SECTION. Tube requires miniature nine-contact socket and may be mounted in any position. Heater volts (ac/dc), 6.3; amperes, 0.75.

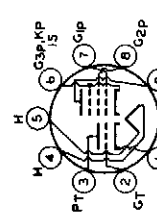

CLASS A₁ AMPLIFIER

Maximum Ratings, (Design-Maximum Values):

PLATE VOLTAGE.....	Triode Unit	Pentode Unit
Grid-No.2 (SCREEN-GRID) SUPPLY VOLTAGE.....	330 maz	330 maz
Grid-No.2 Voltage.....	—	380 maz
Grid-No.1 (CONTROL-GRID) VOLTAGE, Positive-bias value.....	0 maz	See curve page 70
Plate Dissipation.....	2 maz	0 maz
Grid-No.2 Input.....	—	5 maz
For grid-No.2 voltages up to 165 volts.....	—	1.1 maz
For grid-No.2 voltages between 165 and 330 volts.....	—	See curve page 70
Peak Heater-Cathode Voltage.....	200 maz	200 maz
Heater negative with respect to cathode.....	240 ^m maz	200 ^m maz
Heater positive with respect to cathode.....	—	—

Characteristics:

Plate Supply Voltage.....	150	200
Grid-No.2 Supply Voltage.....	150	125
Cathode-Bias Resistor.....	40	68
Amplification Factor.....	8700	70000
Plate Resistance (Approx.).....	4600	10000
Transconductance.....	-5	-8.5
Grid-No.1 Voltage (Approx.) for plate current of 100 μ a.....	9.2	24
Plate Current.....	—	5.2

Maximum Circuit Values:
 Grid-No.1-Circuit Resistance: 0.5 maz megohm
 For fixed-bias operation: 1 maz megohm
 For cathode-bias operation: 1 maz megohm
 The dc component must not exceed 100 volts.

SHARP-CUTOFF TETRODE
 Miniature type used as rf amplifier in vhf tuners of television receivers. Outline 7B, OUTLINES SECTION. Tube requires miniature seven-contact socket and may be mounted in any position.

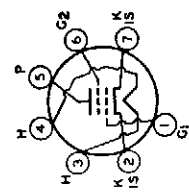

Characteristics:

Plate Supply Voltage.....	125	125
Grid-No.2 Supply Voltage.....	—	—
Grid-No.1 Voltage.....	-1	56
Cathode-Bias Resistor.....	24	17000
Amplification Factor.....	4100	7800
Plate Resistance (Approx.).....	5800	8
Transconductance.....	-19	12
Grid-No.1 Voltage (Approx.) for plate current of 20 μ a.....	17	—
Plate Current.....	—	—
Plate Current for grid-No.1 voltage of -8 volts and cathode-bias resistor of 0 ohms.....	1.6	3.8
Grid-No.2 Current.....	—	—

The dc component must not exceed 100 volts.

HIGH-MU TRIODE

Navistor type used as a grounded-cathode, neutralized rf amplifier in vhf tuners of television and FM receivers. Outline 1, OUTLINES SECTION. Tube requires navistor socket and may be operated in any position.

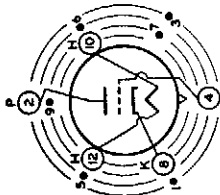

INDEX=LARGE LUG
 ●=PIN CUT OFF

HEATER VOLTAGE (AC/DC)..... 6.3 volts
HEATER CURRENT..... 0.185 amp
DIRECT INTERELECTRODE CAPACITANCES (Approx.):
 Grid to Plate..... 0.92 pf
 Grid to Cathode, Heater, and Shell..... 4.5 pf
 Plate to Cathode, Heater, and Shell..... 4.8 pf
 Plate to Cathode..... 0.18 pf
 Heater to Cathode..... 1.6 pf

CLASS A₁ AMPLIFIER

Maximum Ratings, (Design-Maximum Values):

PLATE SUPPLY VOLTAGE.....	300 ^m maz
Plate Voltage.....	195 maz
Grid Voltage.....	55 maz
Negative-bias value.....	0 maz
Peak positive value.....	1.5 maz
Plate Dissipation.....	15 maz
Cathode Current.....	100 maz
Peak Heater-Cathode Voltage.....	100 maz
Heater negative with respect to cathode.....	—
Heater positive with respect to cathode.....	—

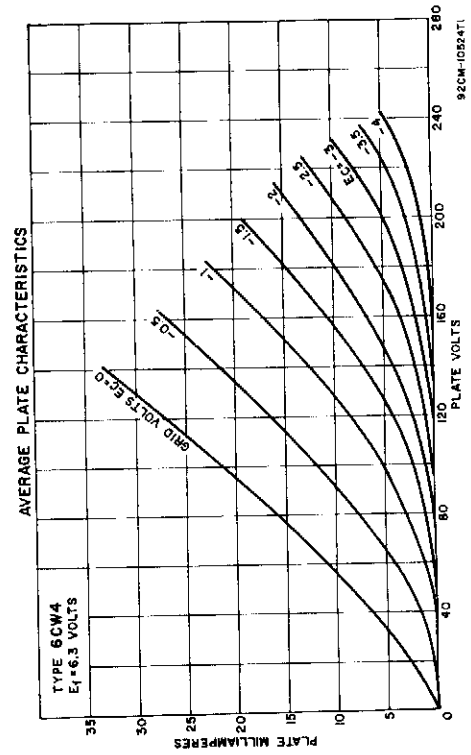

6CW4
 Related types:
 2CW4, 13CW4

6CX8
 Related type:
 6CX8

HEATER VOLTAGE (AC/DC).....	6.3	volts
HEATER CURRENT.....	0.2	ampere
DIRECT INTERELECTRODE CAPACITANCES (Approx.): [†]		
Grid-No.1 to Cathode.....	0.03	pf
Grid-No.1 to Plate.....	4.5	pf
Plate to Cathode, Heater, Grid No.2, and Internal Shield.....	3	pf
Plate to external shield connected to cathode.....		
CLASS A₁ AMPLIFIER		
<i>Maximum Ratings, (Design-Maximum Values):</i>		
PLATE VOLTAGE.....	180 max	volts
GRID-NO.2 (SCREEN-GRID) SUPPLY VOLTAGE.....	180 max	volts
GRID-NO.2 VOLTAGE.....	See curve page 70	volts
GRID-NO.1 (CONTROL-GRID) VOLTAGE, Positive-bias value.....	0 max	volts
CATHODE CURRENT.....	20 max	ma
GRID-NO.2 INPUT: For grid-No.2 voltages up to 90 volts.....	0.5 max	watt
For grid-No.2 voltages between 90 and 180 volts.....	2 max	watts
PLATE DISSIPATION.....	100 max	volts
PEAK HEATER-CATHODE VOLTAGE: Heater negative with respect to cathode.....	100 max	volts
Heater positive with respect to cathode.....		
Characteristics:		
Plate Voltage.....	125	volts
Grid-No.2 Voltage.....	80	volts
Grid-No.1 Voltage.....	-1	volt
Plate Resistance (Approx.).....	0.1	megohm
Transconductance.....	8000	amhos
Plate Current.....	10	ma
Grid-No.2 Current.....	1.5	ma
Grid-No.1 Voltage (Approx.) for plate current of 20 μ a.....	-6	volts
Maximum Circuit Value:		
Grid-No.1-Circuit Resistance.....	0.5 max	megohm

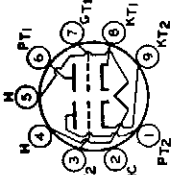
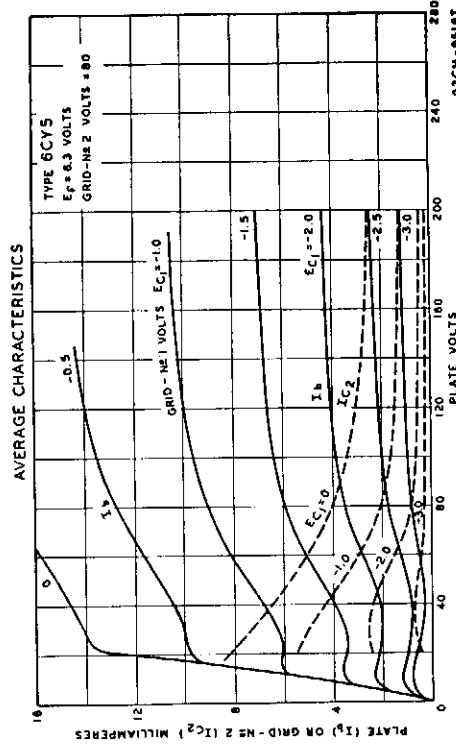

DUAL TRIODE

Miniature type used as combined vertical oscillator and vertical deflection amplifier in television receivers. Unit No.1 is a high- μ u triode unit used as a blocking oscillator in vertical deflection circuits, and unit No.2 is a low- μ u triode unit used as a vertical deflection amplifier. Outline 8D, OUTLINES SECTION. Tube requires miniature nine-contact socket and may be mounted in any position. Heater volts (ac/dc), 6.3; amperes, 0.75.

6CY7
Related type:
11CY7

CLASS A₁ AMPLIFIER

Characteristics:	Unit No.1	Unit No.2
Plate Supply Voltage.....	250	150
Grid Voltage.....	-3	
Cathode-Bias Resistor.....		620
Amplification Factor.....	68	5
Plate Resistance (Approx.).....	52000	920
Transconductance.....	1300	5400
Grid Voltage (Approx.) for plate current of 10 μ a.....	-5.5	
Grid Voltage (Approx.) for plate current of 200 μ a.....		-40
Plate Current.....	1.2	30
Plate Current for grid voltage of -80 volts.....		3.5

VERTICAL DEFLECTION OSCILLATOR AND AMPLIFIER

For operation in a 525-line, 30-frame system

Maximum Ratings, (Design-Maximum Values):	Unit No.1	Unit No.2
DC PLATE VOLTAGE.....	350 max	Amplifier
PEAK POSITIVE-PULSE PLATE VOLTAGE.....	1800 max	350 max
PEAK NEGATIVE-PULSE PLATE VOLTAGE.....	-250 max	1800 max
PEAK CATHODE CURRENT.....	120 max	35 max
AVERAGE CATHODE CURRENT.....	1	5.5 max
PLATE DISSIPATION.....		
PEAK HEATER-CATHODE VOLTAGE: Heater negative with respect to cathode.....	200 max	200 max
Heater positive with respect to cathode.....	200 max	200 max

Maximum Circuit Values:

Grid-Circuit Resistance.....	2.2 max	2.2 max
Grid-Circuit Resistance.....	2.2 max	2.2 max
† The duration of the voltage pulse must not exceed 15 per cent of one vertical scanning cycle. In a 525-line, 30-frame system, 15 per cent of one vertical scanning cycle is 2.5 milliseconds.		
‡ The dc component must not exceed 100 volts.		
† For cathode-bias operation.		

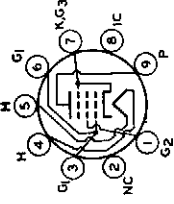

BEAM POWER TUBE

Miniature type used as a vertical deflection amplifier in high-efficiency deflection circuits of television receivers utilizing picture tubes having diagonal deflection angles of 110 degrees and operating at ultr voltages up to 18 kilovolts. Also used in the audio output stage of television and radio receivers. This type has a controlled heater warm-up time for use in receivers employing series-connected heater strings. Outline 8E, OUTLINES SECTION. Tube requires miniature nine-contact socket and may be mounted in any position.

6CZ5
Related type:
5CZ5

HEATER VOLTAGE (AC/DC).....	6.3	volts
HEATER CURRENT.....	0.45	ampere
HEATER WARM-UP TIME (Average).....	11	seconds
DIRECT INTERELECTRODE CAPACITANCES:		
Grid No.1 to Plate.....	0.4 max	pf
Plate to Cathode, Heater, Grid No.2, and Grid No.3.....	9	pf
Plate to Cathode, Heater, Grid No.2, and Grid No.3.....	6	pf
PLATE RESISTANCE (Approx.) [†]	0.073	megohm
TRANSCONDUCTANCE [†]	4800	amhos
* Plate and grid-No.2 volts, 250; grid-No.1 volts, -14; plate ma, 46; grid-No.2 ma., 4.6.		

VERTICAL DEFLECTION AMPLIFIER

For operation in a 525-line, 30-frame system

Maximum Ratings, (Design-Maximum Values):	
DC PLATE VOLTAGE.....	350 max
PEAK POSITIVE-PULSE PLATE VOLTAGE.....	2200 max
GRID-NO.2 (SCREEN-GRID) VOLTAGE.....	315 max
PEAK NEGATIVE-PULSE GRID-NO.1 (CONTROL-GRID) VOLTAGE.....	-275 max
PEAK CATHODE CURRENT.....	155 max
AVERAGE CATHODE CURRENT.....	45 max
PLATE DISSIPATION.....	10 max
GRID-NO.2 INPUT: Heater negative with respect to cathode.....	200 max
Heater positive with respect to cathode.....	200 max
BULB TEMPERATURE (At hottest point).....	250 max

Maximum Circuit Values:

Grid-No.1-Circuit Resistance: 0.5 maz megohm
 For fixed-bias operation: 1.0 maz megohm
 For cathode-bias operation: 1.0 maz megohm
 # The duration of the voltage pulse must not exceed 15 per cent of one vertical scanning cycle. In a 525-line, 30-frame system, 15 per cent of one vertical scanning cycle is 2.5 milliseconds.
 * The dc component must not exceed 100 volts.

REMOTE-CUTOFF PENTODE

Glass type used in rf and if stages of radio receiver employing a.v.c. Outline 24A, OUTLINES SECTION. Tube requires six-contact socket. Except for interelectrode capacitances, this type is identical electrically with type 6U7-G. Refer to type 6SK7 for application information. Heater volts (ac/dc), 6.3; amperes, 0.3. This type is used principally for renewal purposes.

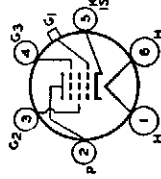

6D6

SHARP-CUTOFF PENTODE

Glass type used as detector or amplifier in radio receivers. Outline 24A, OUTLINES SECTION. Heater volts (ac/dc), 6.3; amperes, 0.3. For electrical characteristics, refer to type 6J7. Type 6D7 is a DISCONTINUED type listed for reference only.



6D7

PENTAGRID CONVERTER

Glass octal type used in superheterodyne circuits. Outline 23, OUTLINES SECTION. Tube requires octal socket. Heater volts (ac/dc), 6.3; amperes, 0.15. Except for interelectrode capacitances and heater rating, the 6D8-G is similar electrically to type 6A8-G. Type 6D8-G is a DISCONTINUED type listed for reference only.



6D8G

HALF-WAVE VACUUM RECTIFIER

Glass octal type used as damper tube in horizontal-deflection circuits of television receivers. Outline 14C, OUTLINES SECTION. Tube requires octal socket and may be mounted

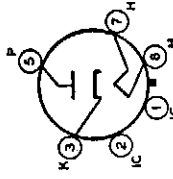

6DA4

Related types: 17D4

in any position. May be supplied with pin No.1 omitted. Socket terminals 1, 2, 4, and 6 should not be used as tie points. It is important that this tube, like other power-handling tubes, be adequately ventilated. Heater volts (ac/dc), 6.3; amperes, 1.2.

DAMPER SERVICE

For operation in a 525-line, 30-frame system

Maximum Ratings, (Design-M (Minimum Values):	
PEAK INVERSE PLATE CURRENT*	4400 max volts
PEAK PLATE CURRENT	900 maz ma
DC PLATE CURRENT	155 maz ma
PLATE DISSIPATION	5.5 maz watts
PEAK HEATER-CATHODE VOLTAGE:	
Heater positive with respect to cathode.	4400* maz volts
Heater negative with respect to cathode.	300* maz volts
* The duration of the voltage pulse must not exceed 15 per cent of one horizontal scanning cycle. In a 525-line, 30-frame system, 15 per cent of one horizontal scanning cycle is 10 microseconds.	
† The dc component must not exceed 900 volts.	
‡ The dc component must not exceed 100 volts.	

BEAM POWER TUBE

Miniature type used as vertical-deflection-amplifier tube in television receivers. Outline 8D, OUTLINES SECTION, except all vertical dimensions of this type are 1/8 inch greater.

6DB5

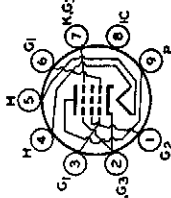

Tube requires miniature nine-contact socket and may be operated in any position. Heater volts (ac/dc), 6.3; amperes, 1.2. Except for heater ratings, this type is identical with miniature type 12DB5.

SHARP-CUTOFF PENTODE

Miniature type used in the gain-controlled picture-if stages of color television receivers. It is also used as a radio-frequency amplifier in the tuners of such receivers. Outline 7B, OUTLINES SECTION. Tube requires seven-contact miniature socket and may be mounted in any position.

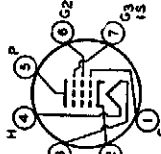

6DC6

HEATER VOLTAGE (AC/DC)	6.3 volts
HEATER CURRENT	0.3 ampere
DIRECT INTERELECTRODE CAPACITANCES:	
Grid No.1 to Plate	0.02 maz
Grid No.1 to Cathode, Heater, Grid No.3, and Internal Shield	6.5 maz
Plate to Cathode, Heater, Grid No.3, and Internal Shield.....	2 maz

CLASS A1-AMPLIFIER

Maximum Ratings, (Design-Center Values):

PLATE VOLTAGE	300 maz volts
Grid-No.3 (SUPPRESSOR-GRID) VOLTAGE, Positive value	0 maz volts
Grid-No.2 SUPPLY VOLTAGE	300 maz volts
Grid-No.2 (SCREEN-GRID) VOLTAGE	See curve page 70
Grid-No.1 (CONTROL-GRID) VOLTAGE, Positive-bias value	0 maz volts
PLATE DISSIPATION	2 maz watts
Grid-No.2 INPUT:	
For grid-No.2 voltages up to 150 volts	0.5 maz watt
For grid-No.2 voltages between 150 and 300 volts	See curve page 70
PEAK HEATER-CATHODE VOLTAGE:	
Heater negative with respect to cathode	200 maz volts
Heater positive with respect to cathode	200* maz volts
Characteristics:	
Plate Supply Voltage	200 volts
Grid No.3	Connected to cathode at socket
Grid-No.2 Supply Voltage	150 volts
Cathode-Bias Resistor	180 ohms
Plate Resistance (Approx.)	0.5 megohm
Transconductance	5500 micromhos
Grid-No.1 Voltage (Approx.) for transconductance of 50 micromhos	-12.5 volts
Plate Current	9 ma
Grid-No.2 Current	3 ma
Maximum Circuit Values:	
Grid-No.1-Circuit Resistance:	0.25 maz megohm
For fixed-bias operation	1.0 maz megohm
For cathode-bias operation	
* The dc component must not exceed 100 volts.	

AVERAGE PLATE CHARACTERISTICS

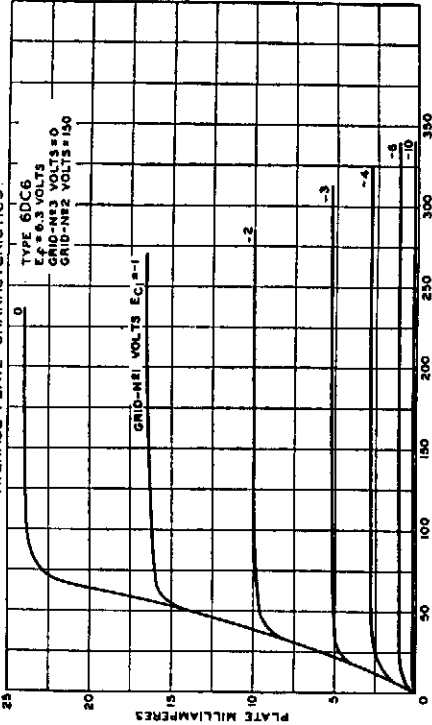

TWIN DIODE— SEMIREMOTE-CUTOFF PENTODE

6DC8
Miniature type used as rf- and if-amplifier tubes in radio and television receivers. Outline 8D, OUTLINES SECTION. Tube requires nine-contact socket and may be mounted in any position. Heater volts (ac/dc), 6.3; amperes, 0.3.

PENTODE UNIT AS CLASS A₁ AMPLIFIER

Maximum Ratings, (Design-Center Values):

PLATE SUPPLY VOLTAGE.....	200 volts
Grid-No.2 Voltage.....	Connected to cathode at socket
Grid-No.1 Voltage.....	100 volts
Grid-No.2 Voltage.....	100 volts
Grid-No.1 Voltage.....	-0.5 volts
Mu-Factor, Grid No.2 to Grid No.1.....	0.6
Plate Resistance (Approx.).....	4600 megohm
Transconductance.....	0.6 μmhos
Plate Current.....	11 ma
Grid-No.2 Current.....	3.3 ma
Transconductance, at grid-No.1 voltage of -20 volts.....	120 μmhos

Characteristics:

Plate Voltage.....	200 volts
Grid No.3.....	Connected to cathode at socket
Grid-No.2 Voltage.....	100 volts
Grid-No.1 Voltage.....	100 volts
Mu-Factor, Grid No.2 to Grid No.1.....	0.6
Plate Resistance (Approx.).....	4600 megohm
Transconductance.....	0.6 μmhos
Plate Current.....	11 ma
Grid-No.2 Current.....	3.3 ma
Transconductance, at grid-No.1 voltage of -20 volts.....	120 μmhos

DIODE UNITS (Each Unit)

Maximum Ratings, (Design-Center Values):	
PEAK INVERSE PLATE VOLTAGE.....	200 maz
PEAK PLATE CURRENT.....	5 maz
AVERAGE PLATE CURRENT.....	0.8 maz

HALF-WAVE VACUUM RECTIFIER

Glass octal type used as damper tube in horizontal-deflection circuits of television receivers. Outline 14F, OUTLINES SECTION. Tube requires octal socket and may be operated in any position. Socket terminals 1, 2, 4, and 6 should not be used as tie points. It is important that this tube, like other power-handling tubes, be adequately ventilated.

6DE4

Related types:
17DE4, 22DE4

HEATER VOLTAGE (AC/DC)..... 6.3 volts

HEATER CURRENT..... 1.6 amperes

DIRECT INTERELECTRODE CAPACITANCES (Approx.):

Plate to Cathode and Heater.....	8.5 pf
Cathode to Plate and Heater.....	11.5 pf
Heater to Cathode.....	4 pf

DAMPER SERVICE

For operation in a 525-line, 50-frame system

Maximum Ratings, (Design-Maximum Values):

PEAK INVERSE PLATE VOLTAGE#.....	5500 maz
PEAK PLATE CURRENT.....	1100 maz
DC PLATE CURRENT.....	180 maz
PLATE DISSIPATION.....	6.5 maz

PEAK HEATER-CATHODE VOLTAGE:

Heater negative with respect to cathode.....	5500 ^{max} maz	volts
Heater positive with respect to cathode.....	300 ^{max} maz	volts

Characteristics, Instantaneous Value:

Tube Voltage Drop for plate current of 350 ma.....	34	volts
--	----	-------

The duration of the voltage pulse must not exceed 15 per cent of one horizontal scanning cycle. In a 525-line, 30-frame system, 15 per cent of one horizontal scanning cycle is 10 microseconds.

• The dc component must not exceed 900 volts.

• The dc component must not exceed 100 volts.

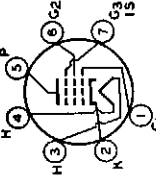

SHARP-CUTOFF PENTODE

Miniature type used in the gain-controlled picture if stages of television receivers utilizing an intermediate frequency in the order of 40 megacycles per second. Also used as an rf amplifier in vhf television tuners. This tube features very high transconductance combined with low interelectrode capacitance values, and is provided with separate base pins for grid No.3 and cathode to permit the use of an unbypassed cathode resistor to minimize the effects of regeneration. Outline 7B, OUTLINES SECTION. Tube requires miniature seven-contact socket and may be mounted in any position.

HEATER VOLTAGE (AC/DC)..... 6.3 volts

HEATER CURRENT..... 0.3 ampere

DIRECT INTERELECTRODE CAPACITANCES:

Grid No.1 to Plate.....	Without External Shield.....	6.3	volts
Grid No.1 to Cathode, Heater, Grid No.2, Grid No.3, and Internal Shield.....	With External Shield.....	0.3	ampere
Plate to Cathode, Heater, Grid No.2, Grid No.3, and Internal Shield.....	Without External Shield.....	0.025 maz	0.015 maz
.....	With External Shield.....	5.5	6.5
.....	2	3

CLASS A₁ AMPLIFIER

Maximum Ratings, (Design-Maximum Values):

PLATE VOLTAGE.....	330 maz	volts
Grid-No.3 (SUPPRESSOR-GRID) VOLTAGE, Positive value.....	0 maz	volts
Grid-No.2 (SCREEN-GRID) SUPPLY VOLTAGE.....	330 maz	volts
Grid-No.2 VOLTAGE.....	See curve page 70	volts
Grid-No.1 (CONTROL-GRID) VOLTAGE, Positive-bias value.....	0 maz	volts
PLATE DISSIPATION.....	2.3 maz	watts
Grid-No.2 Input.....	0.55 maz	watt
For grid-No.2 voltages up to 165 volts.....	See curve page 70	volts
For grid-No.2 voltages between 165 and 330 volts.....	volts

PEAK HEATER-CATHODE VOLTAGE:

Heater negative with respect to cathode.....	200 maz	volts
Heater positive with respect to cathode.....	200 ^{max} maz	volts

Characteristics:

Plate Supply Voltage.....	125	volts
Grid No.3.....	Connected to cathode at socket	volts

AVERAGE PLATE CHARACTERISTICS

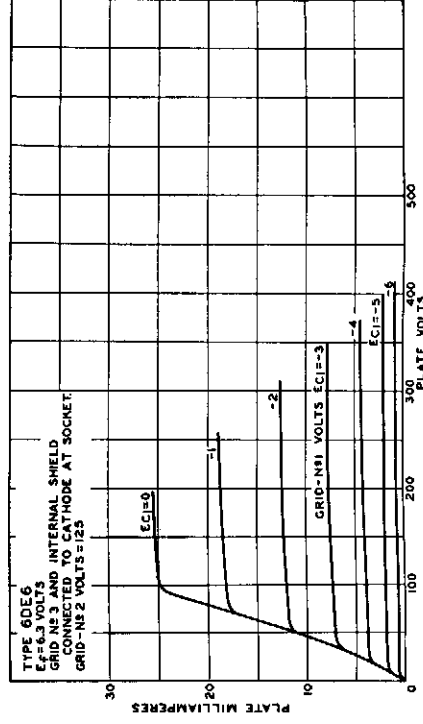

Grid-No.2 Supply Voltage..... volts
 Cathode-Bias Resistor..... ohms
 Plate Resistance (Approx.)..... megohm
 Transconductance..... amhos
 Grid-No.1 Voltage (Approx.) for 0 ohms cathode resistor of 0 ohms..... volts
 Plate Current..... ma
 Grid-No.2 Current..... ma
 * The dc component must not exceed 100 volts.



DUAL TRIODE

Miniature type used as combined vertical oscillator and vertical-deflection amplifier in television receivers. Unit No.1 is a medium- μ triode unit used as a blocking oscillator in vertical-deflection circuits, and unit No.2 is a low- μ triode unit used as a vertical-deflection amplifier. Outline 8D, OUTLINES SECTION. Tube requires miniature nine-contact socket and may be mounted in any position. For curve of average plate characteristics, Unit No.2, refer to type 6DR7.

6DE7

Related types:
 10DE7, 13DE7

HEATER VOLTAGE (AC/DC).....	6.3	volts
HEATER CURRENT.....	0.3	ampere
DIRECT INTERELECTRODE CAPACITANCES (Approx.):		
Grid to Plate.....	Unit No.1	4
Grid to Cathode and Heater.....	2.2	pf
Plate to Cathode and Heater.....	6.52	pf

CLASS A₁ AMPLIFIER

Characteristics:	Unit No.1	Unit No.2
Plate Voltage.....	250	150
Grid Voltage.....	-11	-17.5
Amplification Factor.....	17.5	6
Plate Resistance (Approx.).....	8750	925
Transconductance.....	2000	6500
Plate Current.....	5.5	35
Plate Current for grid voltage of -24 volts.....	10	ma
Grid Voltage (Approx.) for plate current of 10 μ a.....	-20	volts
Grid Voltage (Approx.) for plate current of 50 μ a.....	-	-44

AVERAGE PLATE CHARACTERISTICS

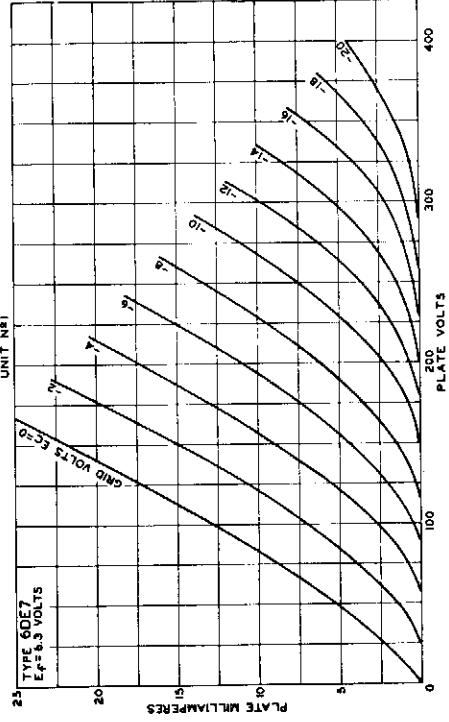

VERTICAL-DEFLECTION OSCILLATOR AND AMPLIFIER

For operation in a 525-line, 30-frame system

Maximum Ratings, (Design-Maximum Values):	Unit No.1	Unit No.2
DC PLATE VOLTAGE.....	Oscillator	Amplifier
PEAK POSITIVE-PULSE PLATE VOLTAGE#.....	330 maz	275 maz
PEAK NEGATIVE-PULSE GRID VOLTAGE#.....	-400 maz	1500 maz
PEAK CATHODE CURRENT.....	22 maz	175 maz
AVERAGE CATHODE CURRENT.....	50 maz	50 maz

PLATE DISSIPATION..... 1.5 maz
 PEAK HEATER-CATHODE VOLTAGE..... 7 maz
 Heater negative with respect to cathode..... 200 maz
 Heater positive with respect to cathode..... 200 maz

Maximum Circuit Values:

Grid-Circuit Resistance:
 For grid-resistor bias or cathode-bias operation..... 2.2 maz
 * The duration of the voltage pulses must not exceed 15 per cent of one vertical scanning cycle. In a 525-line, 30-frame system, 15 per cent of one vertical scanning cycle is 2.5 milliseconds.
 † The dc component must not exceed 100 volts.

BEAM POWER TUBE

Glass octal type used as output tube in audio-amplifier applications. Outline 14C, OUTLINES SECTION. Tube requires octal socket and may be mounted in any position. This type may be supplied with pin 1 omitted.

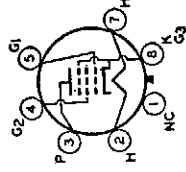

6DG6GT

HEATER VOLTAGE (AC/DC).....	6.3	volts
HEATER CURRENT.....	1.2	amperes
DIRECT INTERELECTRODE CAPACITANCES (Approx.):		
Grid No.1 to Plate.....	0.6	pf
Grid No.1 to Cathode, Heater, Grid No.2, and Grid No.3.....	15	pf
Plate to Cathode, Heater, Grid No.2, and Grid No.3.....	10	pf

CLASS A₁ AUDIO-FREQUENCY POWER AMPLIFIER

(Design-Center Values):

Maximum Ratings, (Design-Center Values):	
PLATE VOLTAGE.....	200 maz
GRID-NO.2 (SCREEN-GRID) VOLTAGE.....	125 volts
PLATE DISSIPATION.....	10 maz
GRID-NO.2 INPUT.....	1.25 maz
PEAK HEATER-CATHODE VOLTAGE.....	200 maz
Heater negative with respect to cathode.....	200 maz
Heater positive with respect to cathode.....	200 maz

Typical Operation:

Plate Supply Voltage.....	110	volts
Grid-No.2 Supply Voltage.....	110	volts
Grid-No.1 (Control-Grid) Supply Voltage.....	-7.5	volts
Peak AF Grid-No.1 Voltage.....	7.5	volts
Cathode-Bias Resistor.....	-	ohms
Zero-Signal Plate Current.....	49	ma
Maximum-Signal Plate Current.....	50	ma
Zero-Signal Grid-No.2 Current.....	4	ma
Maximum-Signal Grid-No.2 Current.....	10	ma
Plate Resistance (Approx.).....	19000	ohms
Transconductance.....	8000	amhos
Load Resistance.....	2000	ohms
Total Harmonic Distortion.....	10	per cent
Maximum-Signal Power Output.....	2.1	watts

Maximum Circuit Values:

Grid-No.1-Circuit Resistance:
 For fixed-bias operation..... 0.1 maz
 For cathode-bias operation..... 0.5 maz
 * The dc component must not exceed 100 volts.

SHARP-CUTOFF PENTODE

Miniature type used as intermediate-frequency amplifier tube in television receivers. This tube features high transconductance at low plate and grid-No.2 voltages, combined with low interelectrode capacitances. Outline 7B, OUTLINES SECTION. Tube requires miniature seven-contact socket and may be mounted in any position.

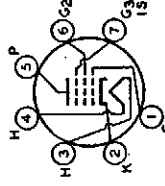

6DK6

Related types:
 3DK6, 12DK6

HEATER VOLTAGE (AC/DC).....	6.3	volts
HEATER CURRENT.....	0.3	ampere
DIRECT INTERELECTRODE CAPACITANCES:		
Grid No.1 to Cathode, Heater, Grid No.2, Grid No.3, and Internal Shield.....	0.025 maz	pf
Plate to Cathode, Heater, Grid No.2, Grid No.3, and Internal Shield.....	6.3	pf
	1.9	pf

CLASS A₁ AMPLIFIER

Maximum Ratings, (Design-Maximum Values):

- PLATE VOLTAGE..... 330 max volts
- GRID-NO.3 (SUPPRESSOR-GRID) VOLTAGE, Positive value..... 0 max volts
- GRID-NO.2 (SCREEN-GRID) SUPPLY VOLTAGE..... 330 max volts
- GRID-NO.2 VOLTAGE..... See curve page 70
- GRID-NO.1 (CONTROL-GRID) VOLTAGE, Positive-bias value..... 0 max volts
- PLATE DISSIPATION..... 2.3 max watts
- GRID-NO.2 INPUT..... 0.55 max watt

- For grid-No.2 voltages up to 165 volts..... See curve page 70
- For grid-No.2 voltages between 165 and 330 volts..... See curve page 70
- PEAK HEATER-CATHODE VOLTAGE..... 200 max volts
- Heater negative with respect to cathode..... 200^m/max volts
- Heater positive with respect to cathode.....

Characteristics:

- Grid No.3..... 125 volts
- Grid-No.2 Supply Voltage..... Connected to cathode at socket
- Grid-No.2 Voltage..... 125 volts
- Cathode-Bias Resistor..... 0.35 ohms
- Plate Resistance (Approx.)..... 9800 megohms
- Transconductance..... -6.5 μ mbos
- Grid-No.1 Voltage (Approx.) for plate current of 20 μ a..... 3.12 ma
- Plate Current..... 3.8 ma
- Grid-No.2 Current.....

■ The dc component must not exceed 100 volts.

AVERAGE CHARACTERISTICS

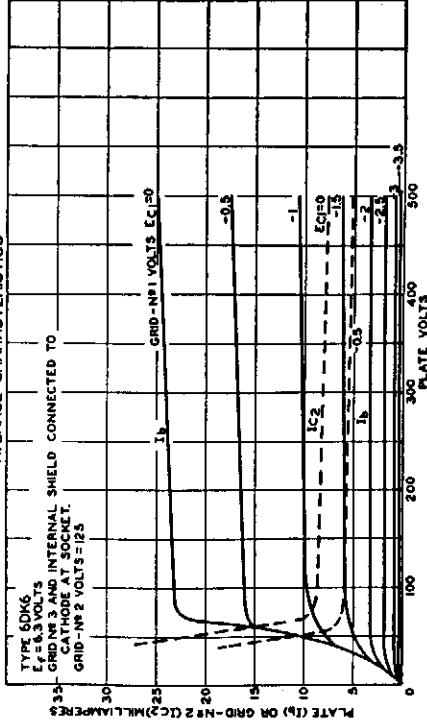

SECM-50871

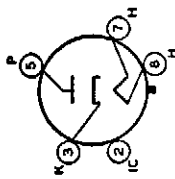

HALF-WAVE VACUUM RECTIFIER

Glass octal type used as damper tube in horizontal-deflection circuits of television receivers. Outline 14F, OUTLINES SECTION. Tube requires octal socket and may be operated in any position. Socket terminals 1, 2, 4, and 6 should not be used as tie points. It is important that this tube, like other power-handling tubes, be adequately ventilated.

6DM4

Related types:
17DM4, 17DM4

- HEATER VOLTAGE (AC/DC)..... 6.3 volts
- HEATER CURRENT..... 1.2 amperes
- DIRECT INTERELECTRODE CAPACITANCES (Approx.):
- Plate to Cathode and Heater..... 8.5 pf
- Cathode to Plate and Heater..... 11.5 pf
- Heater to Cathode..... 4 pf

DAMPER SERVICE

For operation in a 525-line, 80-frame system

- Maximum Ratings, (Design-Maximum Values):
- PEAK INVERSE PLATE VOLTAGE..... 5000 max volts
- PEAK PLATE CURRENT..... 1100 max ma
- DC PLATE CURRENT..... 175 max ma

- PLATE DISSIPATION..... 6.5 max watts
- PEAK HEATER-CATHODE VOLTAGE..... 5000^m/max volts
- Heater negative with respect to cathode..... 300^m/max volts
- Heater positive with respect to cathode.....
- The duration of the voltage pulse must not exceed 15 per cent of one horizontal scanning cycle. In a 525-line, 30-frame system, 15 per cent of one horizontal scanning cycle is 10 microseconds.
- The dc component must not exceed 900 volts.
- The dc component must not exceed 100 volts.

BEAM POWER TUBE

Glass octal type used as horizontal-deflection amplifier tube in television receivers having low B-supply voltages. Outline 25A, OUTLINES SECTION. Tube requires octal socket. Vertical mounting is preferred, but horizontal mounting is permissible if pins 1 and 3 are in vertical plane. Heater volts (ac/dc), 6.3; amperes, 2.5. Except for heater ratings this type is identical with miniature type 25DN6. Type 6DN6 is used principally for renewal purposes.

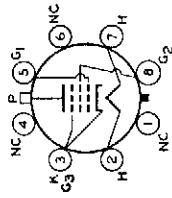

MEDIUM-MU DUAL TRIODE

Glass octal type used as combined vertical-deflection-oscillator and vertical-deflection-amplifier tube in television receivers. Outline 14B, OUTLINES SECTION. Tube requires octal socket and may be mounted in any position. Heater volts (ac/dc), 6.3; amperes, 0.9.

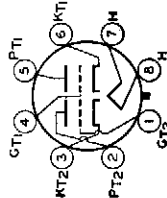

CLASS A₁ AMPLIFIER

- Characteristics:
- Plate Voltage..... 250 volts
- Grid Voltage..... -9.5 volts
- Amplification Factor..... 22.5
- Plate Resistance (Approx.)..... 9000 ohms
- Transconductance..... 2500 μ mbos
- Plate Current..... 8 ma
- Grid Voltage (Approx.) for plate current of 10 μ a..... -18 volts
- Grid Voltage (Approx.) for plate current of 50 μ a..... -23 volts

VERTICAL-DEFLECTION OSCILLATOR AND AMPLIFIER

For operation in a 525-line, 30-frame system

Maximum Ratings, (Design-Maximum Values):

- DC PLATE VOLTAGE..... 350 max volts
- PEAK POSITIVE-PULSE PLATE VOLTAGE..... 2500 max volts
- PEAK NEGATIVE-PULSE GRID VOLTAGE..... 400 max ma
- PEAK CATHODE CURRENT..... 150 max ma
- AVERAGE CATHODE CURRENT..... 50 max ma
- PLATE DISSIPATION..... 10 max watts
- PEAK HEATER-CATHODE VOLTAGE..... 200 max volts
- Heater negative with respect to cathode..... 200^m/max volts
- Heater positive with respect to cathode.....

Maximum Circuit Values:

- Grid-Circuit Resistance..... 2.2 max megohms
- For fixed-bias operation..... 2.2 max megohms
- For cathode-bias operation..... 2.2 max megohms
- The duration of the voltage pulse must not exceed 15 per cent of one vertical scanning cycle. In a 525-line, 30-frame system, 15 per cent of one vertical cycle is 2.5 milliseconds.
- The dc component must not exceed 100 volts.

HALF-WAVE VACUUM RECTIFIER

Glass octal type used as damper tube in horizontal-deflection circuits of television receivers. Outline 14E, OUTLINES SECTION. Tube requires octal socket and may be mounted in any position. Socket terminals 1, 2, 4, and 6 should not be used as tie points. Heater volts (ac/dc), 6.3; amperes, 1.2.

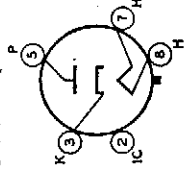

6DQ4

DAMPER SERVICE

For operation in a 525-line, 30-frame system

Maximum Ratings, (Design-Maximum Values):	
PEAK INVERSE PLATE VOLTAGE†	5500 max volts
PEAK PLATE CURRENT	1000 max ma
DC PLATE CURRENT	175 max ma
PLATE DISSIPATION	6 max watts
PEAK HEATER-CATHODE VOLTAGE:	
Heater negative with respect to cathode	5500 max volts
Heater positive with respect to cathode	300 max volts

Characteristics, Instantaneous Value:

Tube Voltage Drop for plate current of 250 ma	32 volts
† The duration of the voltage pulse must not exceed 15 per cent of one horizontal scanning cycle. In a 525-line, 30-frame system, 15 per cent of one horizontal scanning cycle is 10 microseconds.	
‡ The dc component must not exceed 900 volts.	
§ The dc component must not exceed 100 volts.	

BEAM POWER TUBE

Glass octal type used as horizontal deflection amplifier in color television receivers. Outline 25A, OUTLINES SECTION. Tube requires octal socket and may be mounted in any position.

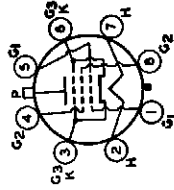

HEATER VOLTAGE (AC/DC)	6.3 volts
HEATER CURRENT	2.5 amperes
DIRECT INTERELECTRODE CAPACITANCES (Approx):	
Grid No.1 to Plate	0.5 pf
Grid No.1 to Cathode, Heater, Grid No.2, and Grid No.3	23 pf
Plate to Cathode, Heater, Grid No.2, and Grid No.3	11 pf
PLATE RESISTANCE (Approx.)*	5500 ohms
TRANSCONDUCTANCE*	10500 μmhos
MU-FACTOR, Grid No.2 to Grid No.1**	3.3

* For plate volts, 175; grid-No.2 volts, 125; grid-No.1 volts, -25; plate ma., 110; grid-No.2 ma., 5.
** For plate and grid-No.2 volts, 125; grid-No.1 volts, -25.

6DQ5

AVERAGE CHARACTERISTICS

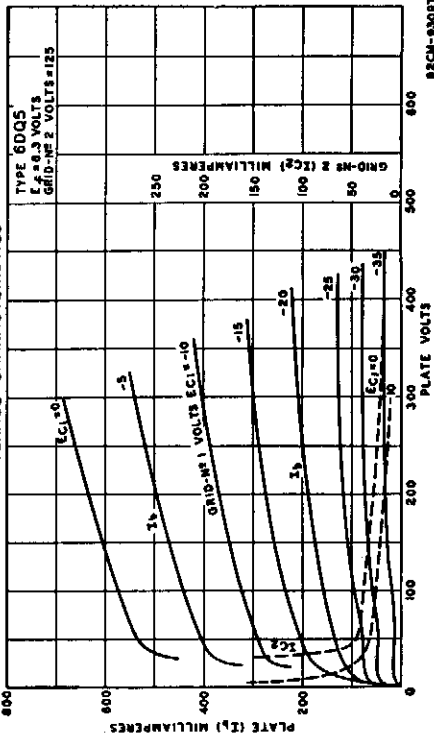

HORIZONTAL DEFLECTION AMPLIFIER

For operation in a 525-line, 30-frame system

Maximum Ratings, (Design-Maximum Values):	
DC PLATE VOLTAGE	990 max volts
PEAK POSITIVE-PULSE PLATE VOLTAGE†	6500 max volts
PEAK NEGATIVE-PULSE PLATE VOLTAGE	-1100 max volts
DC GRID-No.2 (SCREEN-GRID) VOLTAGE	180 max volts
PEAK NEGATIVE-PULSE GRID-No.1 (CONTROL-GRID) VOLTAGE	-250 max volts
PEAK CATHODE CURRENT	1100 max ma
AVERAGE CATHODE CURRENT	315 max ma

GRID-No.2 INPUT	3.2 max watts
PLATE DISSIPATION†	24 max watts
PEAK HEATER-CATHODE VOLTAGE:	
Heater negative with respect to cathode	200 max volts
Heater positive with respect to cathode	200 max volts
BULB TEMPERATURE (At hottest point)	220 max °C
Maximum Circuit Value:	
For grid-resistor-bias operation	0.47 max megohm

† The duration of the voltage pulse must not exceed 15 per cent of one horizontal scanning cycle. In a 525-line, 30-frame system, 15 per cent of one horizontal scanning cycle is 10 microseconds.
‡ An adequate bias resistor or other means is required to protect the tube in the absence of excitation.
§ The dc component must not exceed 100 volts.

AVERAGE CHARACTERISTICS

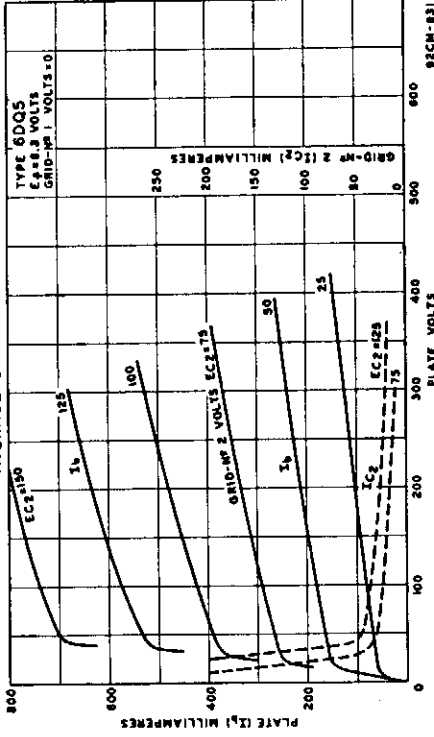

92CM-831IT

BEAM POWER TUBE

Glass octal types used as horizontal-deflection-amplifier tubes in high-efficiency deflection circuits of television receivers. Outline 21, OUTLINES SECTION. Tubes require octal socket and may be mounted in any position. These types may be supplied with pin 1 omitted. Type 6DQ6-A is used principally for renewal purposes.

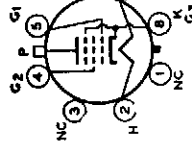

6DQ6A
6DQ6B

Related types:
12DQ6A, 12DQ6B,
17DQ6A, 17DQ6B

HEATER VOLTAGE (AC/DC)	6.3 volts
HEATER CURRENT	1.2 amperes
DIRECT INTERELECTRODE CAPACITANCES (Approx):	
Grid No.1 to Plate	0.5 pf
Grid No.1 to Cathode, Heater, Grid No.2, and Grid No.3	15 pf
Plate to Cathode, Heater, Grid No.2, and Grid No.3	7 pf

CLASS A1 AMPLIFIER

Characteristics:		
Plate Voltage	60	6DQ6-B 250
Grid-No.2 Voltage	150	150
Grid-No.1 Voltage	0	-22.5
Plate Resistance (Approx.)	20000	18000
Transconductance	6800	7300
Plate Current	315°	345°
Grid-No.2 Current	25°	27°
Grid-No.1 Voltage (Approx.) for grid-No.2 volts=180, plate ma=1, plate volts=5000	-40	-42
	-100	-100

HORIZONTAL-DEFLECTION AMPLIFIER

For operation in a 525-line, 30-frame system

Maximum Ratings, (Design-Maximum Values):	
DC PLATE-SUPPLY VOLTAGE	6DQ6-A 990 max volts
PEAK POSITIVE-PULSE PLATE VOLTAGE†	6DQ6-B 6500 max volts
	770 max volts
	6500 max volts

PEAK NEGATIVE-PULSE PLATE VOLTAGE.....	-1500 maz	volts
DC GRID-No.2 (SCREEN-GRID) VOLTAGE.....	220 maz	volts
PEAK NEGATIVE-PULSE GRID-No.1 VOLTAGE.....	-330 maz	volts
PEAK CATHODE CURRENT.....	540 maz	ma
AVERAGE CATHODE CURRENT.....	175 maz	ma
GRID-No.2 INPUT.....	3.6 maz	watts
PLATE DISSIPATION*.....	18 maz	watts
PEAK HEATER-CATHODE VOLTAGE.....	200 maz	volts
Heater negative with respect to cathode.....	200 ^o maz	volts
Heater positive with respect to cathode.....	220 maz	volts
BULB TEMPERATURE (At hottest point).....		°C

Maximum Circuit Values:

- * Grid-No.1-Circuit Resistance for grid-resistor-bias operation..... 1 maz
- † This value can be measured by a method involving a recurrent waveform such that the maximum ratings of the tube will not be exceeded
- ‡ The duration of the voltage pulse must not exceed 15 per cent of one horizontal scanning cycle. In a 525-line, 30-frame system, 15 per cent of one horizontal scanning cycle is 10 microseconds.
- § An adequate bias resistor or other means is required to protect the tube in the absence of excitation.
- ¶ The dc component must not exceed 100 volts.

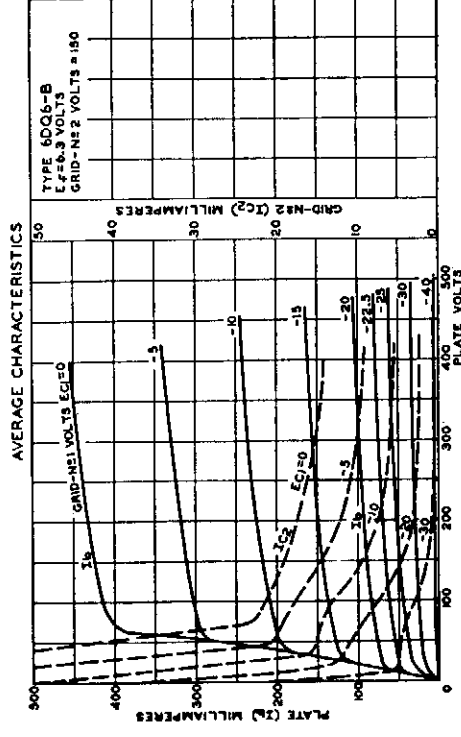

92CM-10535T

DUAL TRIODE

Miniature type containing high- μ and low- μ triodes; used as combined vertical-deflection-oscillator and vertical-deflection-amplifier tube in television receivers. Outline 8D, OUT-LINESSECTION. Tube requires miniature nine-contact socket and may be operated in any position.

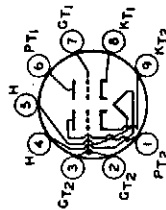

HEATER VOLTAGE (AC/DC).....	6.3	volts
HEATER CURRENT.....	0.3	ampere
DIRECT INTERELECTRODE CAPACITANCES (Approx.):		
Grid to Plate.....	4.5	pf
Grid to Cathode and Heater.....	2.2	pf
Plate to Cathode and Heater.....	0.34	pf

CLASS A₁ AMPLIFIER

Characteristics:		
Plate Voltage.....	U_{mit} No.1	volts
Grid Voltage.....	250	volts
Amplification Factor.....	3	
Plate Resistance (Approx.).....	68	ohms
Transconductance.....	40000	μmhos
Grid Voltage (Approx.) for plate current of 10 μA.....	1500	volts
Plate Voltage (Approx.) for plate current of 50 μA.....	-5.5	volts
Plate Current.....	1.4	ma
Plate Current for grid voltage of -24 volts.....	10	ma

AVERAGE PLATE CHARACTERISTICS

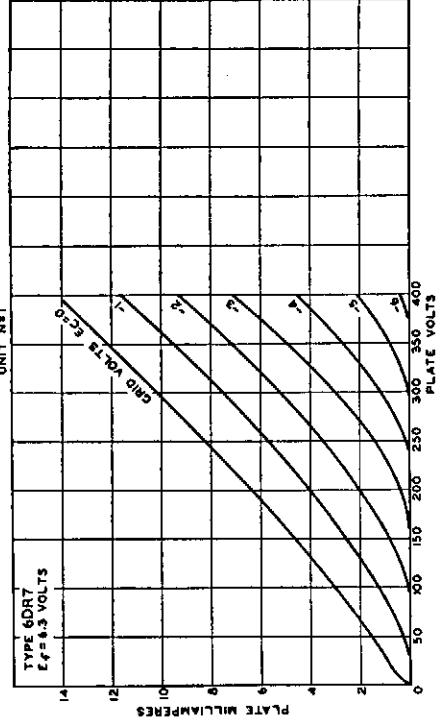

92CM-992T

VERTICAL-DEFLECTION OSCILLATOR AND AMPLIFIER

For operation in a 525-line, 30-frame system

Maximum Ratings, (Design-Maximum Values):		
DC PLATE VOLTAGE.....	Unit No.1	volts
PEAK POSITIVE-PULSE PLATE VOLTAGE [†]	Oscillator	380 maz
PEAK NEGATIVE-PULSE GRID VOLTAGE.....	Amplifier	275 maz
PEAK CATHODE CURRENT.....		1500 maz
AVERAGE CATHODE CURRENT.....		-250 maz
PLATE DISSIPATION.....		175 maz
PEAK HEATER-CATHODE VOLTAGE:		50 maz
Heater negative with respect to cathode.....		1 maz
Heater positive with respect to cathode.....		200 maz
Maximum Circuit Value:		200 maz
Grid-Circuit Resistance:		2.2 maz

Maximum Circuit Value:

- Grid-resistor-bias or cathode-bias operation..... 2.2 maz
- ‡ The duration of the voltage pulse must not exceed 15 per cent of one vertical scanning cycle. In a 525-line, 30-frame system, 15 per cent of one vertical scanning cycle is 2.5 milliseconds.
- § The dc component must not exceed 100 volts.

AVERAGE PLATE CHARACTERISTICS

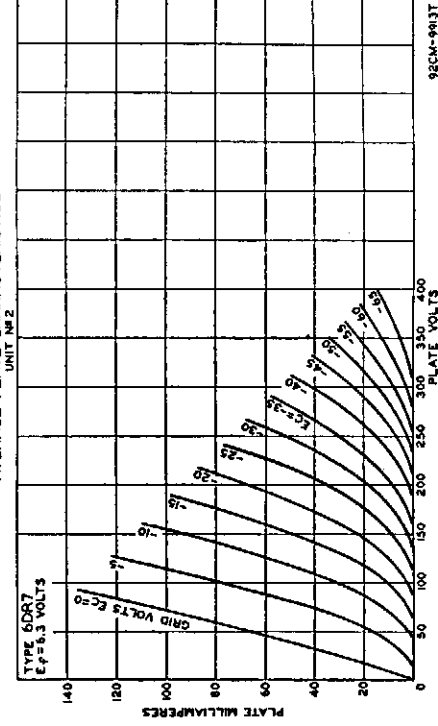

92CM-9413T

HIGH-MU TRIODE

Nuvistor type used as grounded-cathode, neutralized rf amplifier in vhf tuners of television and FM receivers. Because of its cutoff characteristics, the 6DS4 is used in circuits to reduce cross-modulation distortion. Outline 1, OUTLINES SECTION. Tube requires nuvistor socket and may be operated in any position.

6DS4

Related type: 2DS4

HEATER VOLTAGE (AC/DC).....	6.3	volts
HEATER CURRENT.....	0.185	ampere
DIRECT INTERELECTRODE CAPACITANCES (Approx.):		
Grid to Plate.....	0.92	pf
Grid to Cathode, Heater, and Shell.....	4.3	pf
Plate to Cathode, Heater, and Shell.....	1.8	pf
Plate to Cathode.....	0.18	pf
Heater to Cathode.....	1.6	pf

CLASS A₁ AMPLIFIER

Characteristics:		
Plate Supply Voltage.....	110	volts
Grid Supply Voltage.....	0	volts
Cathode-Bias Resistor.....	130	ohms
Amplification Factor.....	63	
Plate Resistance (Approx.).....	7000	ohms
Transconductance.....	9000	μmhos
Plate Current.....	6.5	ma
Grid Voltage (Approx.) for plate current of 100 μa.....	-5	volts
Grid Voltage (Approx.) for plate current of 10 μa.....	-6.8	volts

Maximum Ratings, (Design-Maximum Values):		
PLATE SUPPLY VOLTAGE.....	300 ^{max}	volts
PLATE VOLTAGE.....	135 ^{max}	volts
GRID VOLTAGE, Negative-bias value.....	55 ^{max}	volts
GRID VOLTAGE, Peak positive value.....	0 ^{max}	volts
PLATE DISSIPATION.....	1.5 ^{max}	watt
CATHODE CURRENT.....	15 ^{max}	ma
PEAK HEATER-CATHODE VOLTAGE.....	100 ^{max}	volts
Heater negative with respect to cathode.....	100 ^{max}	volts
Heater positive with respect to cathode.....	100 ^{max}	volts

Typical Operation:		
Plate Voltage.....	70	volts
Grid Supply Voltage.....	0	volts
Grid Resistor.....	47000	ohms
Amplification Factor.....	66	
Plate Resistance (Approx.).....	5440	ohms
Transconductance.....	12600	μmhos
Plate Current.....	7	ma

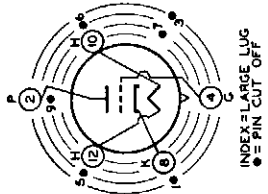
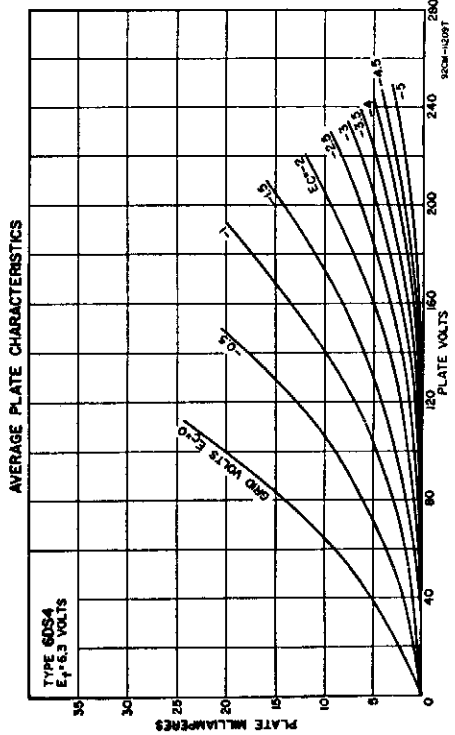

volts	6.3
ampere	0.185
pf	0.92
pf	4.3
pf	1.8
pf	0.18
pf	1.6

volts	110
ohms	0
ohms	130
ohms	63
ohms	7000
μmhos	9000
ma	6.5
volts	-5
volts	-6.8

volts	300 ^{max}
volts	135 ^{max}
volts	55 ^{max}
volts	0 ^{max}
watt	1.5 ^{max}
ma	15 ^{max}
volts	100 ^{max}
volts	100 ^{max}

volts	70
volts	0
ohms	47000
ohms	66
ohms	5440
μmhos	12600
ma	7

Maximum Circuit Values:
Grid-Circuit Resistance.....
For fixed-bias operation.....
For cathode-bias operation.....

* A plate supply voltage of 300 volts may be used provided a sufficiently large resistor is used in the plate circuit to limit the plate dissipation to 1.5 watts under any condition of operation.
† For operation at metal-shell temperatures up to 125°C.

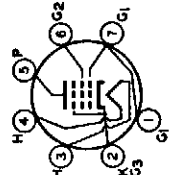

BEAM POWER TUBE

Miniature type used in the audio output stages of television and radio receivers. Outline 7C, OUTLINES SECTION. Tube requires miniature seven-contact socket and may be mounted in any position.

6DS5

HEATER VOLTAGE (AC/DC).....	6.3	volts
HEATER CURRENT.....	0.8	ampere
DIRECT INTERELECTRODE CAPACITANCES (Approx.):		
Grid No.1 to Plate.....	0.19	pf
Grid No.2 to Cathode, Heater, Grid No.2, and Grid No.3.....	9.5	pf
Plate to Cathode, Heater, Grid No.2, and Grid No.3.....	6.3	pf

CLASS A₁ AMPLIFIER

Maximum Ratings, (Design-Maximum Values):		
PLATE VOLTAGE.....	275 ^{max}	volts
GRID-NO.2 (SCREEN-GRID) VOLTAGE.....	275 ^{max}	volts
GRID-NO.1 (CONTROL-GRID) VOLTAGE, Positive bias value.....	0 ^{max}	volts
PLATE DISSIPATION.....	9 ^{max}	watts
GRID-NO.2 INPUT.....	2.2 ^{max}	watts
PEAK HEATER-CATHODE VOLTAGE.....	200 ^{max}	volts
Heater negative with respect to cathode.....	200 ^{max}	volts
Heater positive with respect to cathode.....	250 ^{max}	volts
BULB TEMPERATURE (At hottest point).....	250 ^{max}	°C

Typical Operation and Characteristics:		
Plate Supply Voltage.....	200	volts
Grid-No.2 Supply Voltage.....	250	volts
Grid-No.1 Voltage.....	200	volts
Cathode Bias Resistor.....	180	ohms
Peak-to-Peak Grid-No.2 Current.....	7.5	ma
Zero-Signal Plate Current.....	9.2	ma
Maximum-Signal Plate Current.....	34.2	ma
Zero-Signal Grid-No.2 Current.....	25	ma
Maximum-Signal Grid-No.2 Current.....	36	ma
Plate Resistance (Approx.).....	9	ohms
Transconductance.....	9	μmhos
Load Resistance.....	28000	ohms
Total Harmonic Distortion.....	6000	ohms
Maximum-Signal Power Output.....	6000	ohms
	10	ohms
	3.6	ohms
	9	ohms
	3.8	ohms

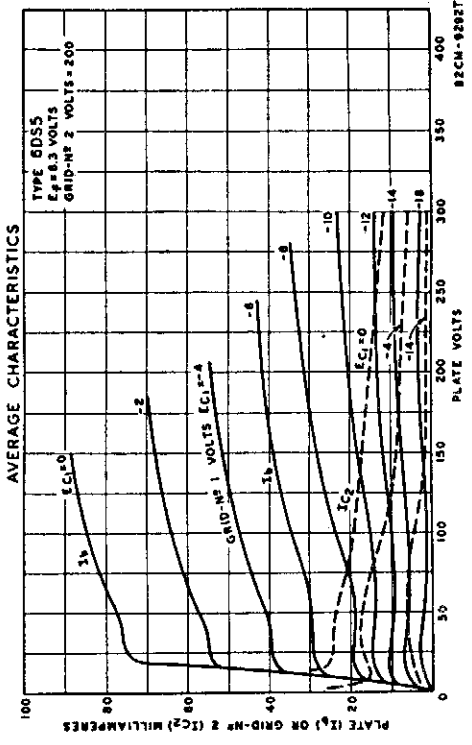

Maximum Circuit Values:
Grid-No.1-Circuit Resistance:
For fixed-bias operation.....
For cathode-bias operation.....
* The dc component must not exceed 100 volts.

HALF-WAVE VACUUM RECTIFIER

Glass octal type used as damper tube in horizontal-deflection circuits of color television receivers. Outline 14F, OUTLINES SECTION. Tube requires octal socket and may be mounted in any position. Socket terminals 1, 2, 4, and 6 should not be used as tie points. Heater volts (ac/dc), 6.3; amperes, 1.2.

6DT4

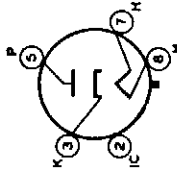

DAMPER SERVICE

For operation in a 525-line, 30-frame system

PEAK INVERSE PLATE VOLTAGE*	5500 max	volts
PEAK PLATE CURRENT	1450 maz	ma
DC PLATE CURRENT	235 maz	ma
PEAK HEATER-CATHODE VOLTAGE:	7.5 maz	watts
Heater negative with respect to cathode.....	5500* maz	volts
Heater positive with respect to cathode.....	300* maz	volts

Characteristics, Instantaneous Values:

Tube Voltage Drop for plate current of 350 ma.....	28	volts
* The duration of the voltage pulse must not exceed 15 per cent of one horizontal scanning cycle. In a 525-line, 30-frame system, 15 per cent of one horizontal scanning cycle is 10 microseconds.		
† The dc component must not exceed 900 volts.		
‡ The dc component must not exceed 100 volts.		

BEAM POWER TUBE

Miniature type used as a vertical-deflection-amplifier tube in television receivers employing 110-degree picture-tube systems. Outline 8D, OUTLINES SECTION. Tube requires miniature nine-contact socket and may be operated in any position.

6DT5

Related types:
12DT5

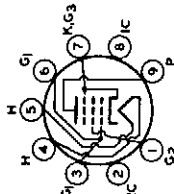

HEATER VOLTAGE (ac/dc).....	6.3	volts
HEATER CURRENT.....	1.2	amperes
TRANSCONDUCTANCE*	6200	micmhos
* For plate and grid-No.2 volts, 250; grid-No.1 volts, -16.5; plate ma., 44; grid-No.2 ma., 1.5.		

VERTICAL-DEFLECTION AMPLIFIER

For operation in a 525-line, 30-frame system

DC PLATE VOLTAGE.....	315 max	volts
PEAK POSITIVE-PULSE PLATE VOLTAGE†	2200 max	volts
GRID-No.2 (SCREEN-GRID) VOLTAGE	285 volts	volts
PEAK NEGATIVE-PULSE GRID-No.1 (CONTROL-GRID) VOLTAGE	-250 max	volts
PEAK CATHODE CURRENT	190 maz	ma
AVERAGE CATHODE CURRENT	55 maz	ma
PLATE DISSIPATION.....	9 maz	watts
GRID-No.2 INPUT.....	2 maz	watts
PEAK HEATER-CATHODE VOLTAGE:		
Heater negative with respect to cathode.....	200 maz	volts
Heater positive with respect to cathode.....	200* maz	volts

Maximum Circuit Values:

Grid-No.1-Circuit Resistance: For fixed-bias operation.....	0.5 maz	megohm
For cathode-bias operation.....	1 maz	megohm
* The duration of the voltage pulse must not exceed 15 per cent of one vertical scanning cycle. In a 525-line, 30-frame system, 15 per cent of one vertical scanning cycle is 2.5 milliseconds.		
† The dc component must not exceed 100 volts.		

SHARP-CUTOFF PENTODE

Miniature type used as FM detector in television receivers. Outline 7B, OUTLINES SECTION. Tube requires miniature seven-contact socket and may be mounted in any position.

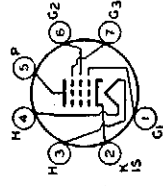

6DT6

Related types:
3DT6A, 4DT6A

Type 6DT6 is a DISCONTINUED type listed for reference only.

HEATER VOLTAGE (ac/dc).....
HEATER CURRENT.....
DIRECT INVERSE-CATHODE CAPACITANCES (Approx.)*

Grid No.1 to Plate.....	0.02	pf
Grid No.1 to Cathode, Heater, Grid No.2, Grid No.3, and Internal Shield	5.8	pf
Grid No.3 to Plate.....	1.4†	pf
Grid No.3 to Grid No.3.....	0.1	pf
Grid No.3 to Cathode, Heater, Grid No.1, Grid No.2, and Internal Shield	6.1	pf

* External shield connected to cathode. † For type 6DT6-A, value is 1.7 µf.

CLASS A₁ AMPLIFIER

6DT6-A

Plate Supply Voltage.....	150	volts
Grid No.3 (Suppressor Grid).....	Connected to cathode at socket	
Grid-No.2 (Screen-Grid) Supply Voltage.....	100	volts
Cathode-Bias Resistor.....	560	ohms
Plate Resistance (Approx.).....	0.15	megohm
Transconductance, Grid No.1 to Plate.....	1350	µmhos
Transconductance, Grid No.3 to Plate.....	515	µmhos
Plate Current.....	1.55	ma
Grid-No.2 Current.....	1.8	ma
Grid-No.1 Voltage (Approx.) for plate current of 10 µa.....	-5.2	volts
Grid-No.3 Voltage (Approx.) for plate current of 10 µa.....	-4.2	volts

FM DETECTOR

Maximum Ratings, (Design-Maximum Values):

PLATE VOLTAGE.....	330 max	volts
GRID-No.3 VOLTAGE.....	28 maz	volts
GRID-No.2 SUPPLY VOLTAGE.....	330 maz	volts
GRID-No.2 VOLTAGE.....	See curve page 70	volts
GRID-No.1 (CONTROL-GRID) VOLTAGE, Positive-bias value.....	0 maz	volts
PLATE DISSIPATION.....	1.7 maz	watts
GRID-No.2 INPUT.....	1.1 maz	watts
For grid-No.2 voltages up to 165 volts.....	See curve page 70	
PEAK HEATER-CATHODE VOLTAGE: Heater negative with respect to cathode.....	200 maz	volts
Heater positive with respect to cathode.....	200* maz	volts

Maximum Circuit Values:

Grid-No.1-Circuit Resistance: For fixed-bias operation.....	0.25 maz	megohm
For cathode-bias operation.....	0.5 maz	megohm
* The dc component must not exceed 100 volts.		

AVERAGE PLATE CHARACTERISTICS

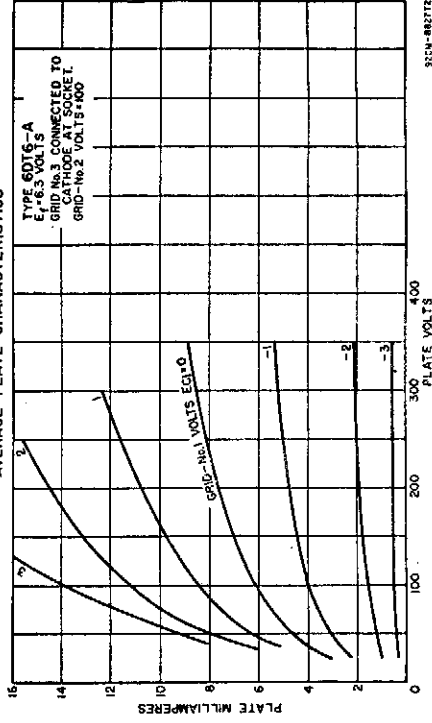

325-482772

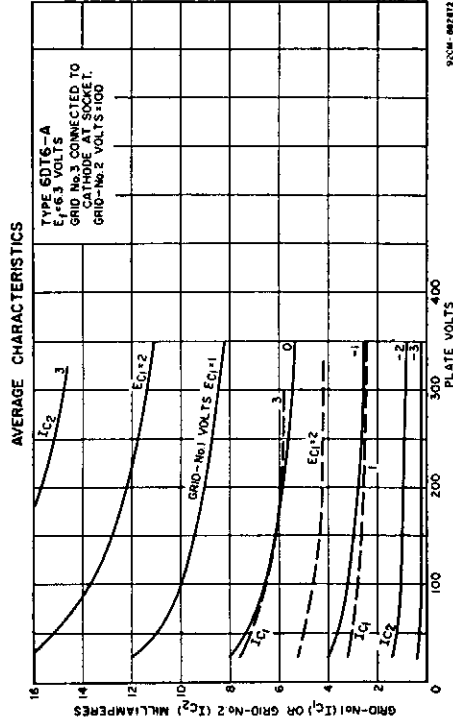

6DT8

Related type:
12DT8

HIGH-MU TWIN TRIODE

Miniature type used in a wide variety of applications in radio and television receivers. Especially useful in push-pull rf amplifiers or as frequency converter in FM tuners. Outline 8B; OUTLINES SECTION. Tube requires miniature nine-contact socket and may be mounted in any position. Heater volts (ac/dc), 6.3; amperes, 0.3. Peak heater-cathode volts: heater negative with respect to cathode, 200 maz; heater positive with respect to cathode, 200 maz; (the dc component must not exceed 100 volts). Except for heater and heater-cathode ratings, interelectrode capacitances, and basing arrangement, this type is identical with miniature type 12AT7.

DIRECT INTERELECTRODE CAPACITANCES (Approx., Each Unit Except as Noted):

Grid to Plate	1.6*	pf
Grid to Cathode, Heater, and Internal Shield	2.7*	pf
Plate to Cathode, Heater, and Internal Shield	1.6*	pf
Heater to Cathode	1.8*	pf
Cathode to Grid, Heater, and Internal Shield (Unit No.2)	5.3†	pf
Plate to Grid, Heater, and Internal Shield (Unit No.2)	2.8†	pf

* With external shield connected to cathode of unit under test.
† With external shield connected to grid of unit under test.

MEDIUM-MU TRIODE

Nuvistor type used at frequencies up to 1000 megacycles in uhf oscillator stages of television receivers. Outline 1, OUTLINES SECTION. Tube requires nuvistor socket and may be mounted in any position.

6DV4

Related type:
2DV4

HEATER VOLTAGE (AC/DC)..... volts
HEATER CURRENT..... amperes
DIRECT INTERELECTRODE CAPACITANCES (Approx.):

Grid to Plate	1.8	pf
Grid to Cathode, Heater, and Shell	4.4	pf
Plate to Cathode, Heater, and Shell	1.9	pf
Plate to Cathode	0.25	pf
Heater to Cathode	1.4	pf
Grid to Cathode	3.7	pf

INDEX-LARGE LUG
• SHORT PIN; IC-00 NOT USE

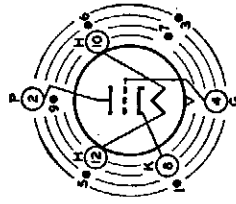

CLASS A1 AMPLIFIER

Maximum Ratings. (Design-Maximum Values):

PLATE SUPPLY VOLTAGE.....	300 maz	volts
PLATE VOLTAGE.....	125 maz	volts
GRID VOLTAGE.....	-55 maz	volts
GRID VOLTAGE.....	2 maz	volts
Grid-Circuit Resistance.....	1 maz	watt
Grid Current.....	15 maz	ma
Plate Current.....	100 maz	volts
Plate Current.....	100 maz	volts

Characteristics:

Plate Supply Voltage.....	75	volts
Cathode-Bias Resistor.....	100	ohms
Amplification Factor.....	35	ohms
Plate Resistance (Approx.).....	3100	ohms
Transconductance.....	11500	μmhos
Grid Voltage (Approx.) for plate current of 10 μa.....	-7	volts
Plate Current.....	10.5	ma

Typical Operation as Oscillator at 950 Mc:

Plate Voltage.....	60	volts
Grid Voltage.....	2	volts
Grid Resistor.....	5600	ohms
Plate Current.....	8	ma
Grid Current.....	350	μa

Maximum Circuit Values:

Grid-Circuit Resistance,*	0.1 maz	megohm
For fixed-bias operation.....	0.2 maz	megohm
For cathode-bias operation.....		

* For operation at metal-shell temperatures up to 135 °C.

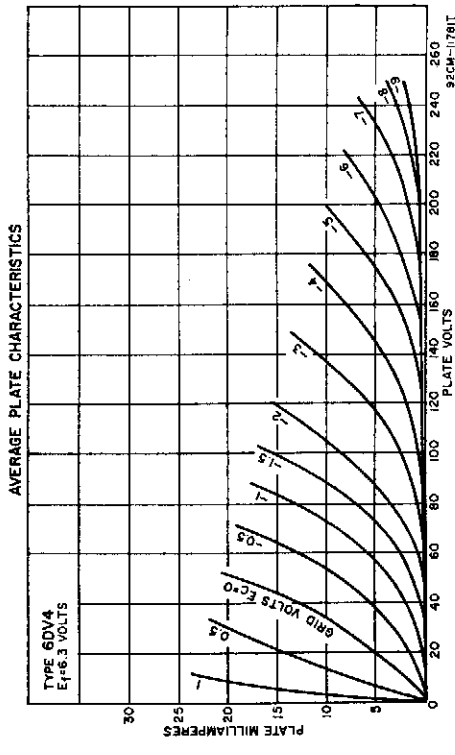

HALF-WAVE VACUUM RECTIFIER

Novar type used as damper tube in horizontal-deflection circuits of color and black-and-white television receivers. Outline 10D, OUTLINES SECTION. Tube requires novar nine-contact socket and may be mounted in any position. Socket terminals 1, 3, 6, and 8 should not be used as tie points; it is recommended that socket clips for these pins be removed to reduce the possibility of arc-over and to minimize leakage. It is especially important that this tube, like other power-handling tubes, be adequately ventilated.

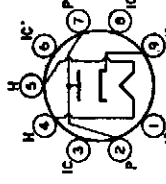

6DW4

HEATER VOLTAGE (AC/DC).....	6.3	volts
HEATER CURRENT.....	1.2	amperes
DIRECT INTERELECTRODE CAPACITANCES (Approx.):		pf
Plate to Cathode and Heater.....	6.5	pf
Cathode to Plate and Heater.....	9	pf
Heater to Cathode.....	2.8	pf

DAMPER SERVICE

For operation in a 525-line, 30-frame system

Maximum Ratings, (Design-Maximum Values):		
PEAK INVERSE PLATE VOLTAGE*	5000 max	volts
PEAK PLATE CURRENT.....	1300 max	ma
DC PLATE CURRENT.....	250 max	ma
PEAK CATHODE CURRENT.....	8.5 max	watts
PLATE DISSIPATION.....		
PEAK HEATER-CATHODE VOLTAGE:		
Heater negative with respect to cathode.....	5000*max	volts
Heater positive with respect to cathode.....	300*max	volts

Characteristics, Instantaneous Value:

- Tube Voltage Drop for plate current of 350 ma..... 25 volts
- The duration of the voltage pulse must not exceed 15 per cent of one horizontal scanning cycle. In a 525-line, 30-frame system, 15 per cent of one horizontal scanning cycle is 10 microseconds.
- The dc component must not exceed 900 volts.
- The dc component must not exceed 100 volts.

BEAM POWER TUBE

Miniature type used in vertical deflection amplifier service in television receivers employing 110-degree deflection systems. Outline 8E, OUTLINES SECTION. Tube requires miniature nine-contact socket and may be operated in any position. Heater volts (ac/dc), 6.3; amperes, 1.2.

6DW5

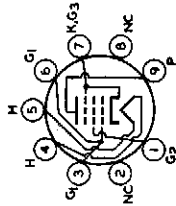

CLASS A₁ AMPLIFIER

Characteristics:		
Plate Voltage.....	60	200
Grid-No.2 Voltage.....	150	150
Grid-No.1 Voltage.....	0	-22.5
Amplification Factor.....	-	4.3
Plate Resistance (Approx.).....	-	15000
Transconductance.....	-	5500
Plate Current.....	260 ^m	55
Grid-No.2 Current.....	20 ^m	2
Grid-No.1 Voltage (Approx.) for plate current of 0.1 ma.....	-	-55

VERTICAL DEFLECTION AMPLIFIER

For operation in a 525-line, 30-frame system*

Maximum Ratings, (Design-Maximum Values):		
DC PLATE VOLTAGE.....	350 max	volts
PEAK POSITIVE-PULSE PLATE VOLTAGE*	2200 max	volts
DC GRID-NO.2 (SCREEN-GRID) VOLTAGE.....	220 max	volts
PEAK NEGATIVE-PULSE GRID-NO.1 (CONTROL-GRID) VOLTAGE.....	-250 max	volts
PEAK CATHODE CURRENT.....	225 max	ma
AVERAGE CATHODE CURRENT.....	65 max	ma
PLATE DISSIPATION.....	11 max	watts
GRID-NO.2 INPUT.....	2.5 max	watts
PEAK HEATER-CATHODE VOLTAGE:		
Heater negative with respect to cathode.....	200 max	volts
Heater positive with respect to cathode.....	200*max	volts

Maximum Circuit Values:

- Grid-No.1 Circuit Resistance:
 - For cathode-bias operation..... 2.2 maz megohms
- With grid No.2 connected to plate.
- This value can be measured by a method involving a recurrent waveform such that the maximum ratings of the tube will not be exceeded.
- The duration of the voltage pulse must not exceed 15 per cent of one vertical scanning cycle. In a 525-line, 30-frame system, 15 per cent of one vertical scanning cycle is 2.5 milliseconds.
- The dc component must not exceed 100 volts.

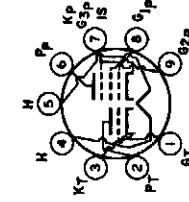

HIGH-MU TRIODE—SHARP-CUTOFF PENTODE

Miniature type used in television-receiver applications. The triode unit is used as a sync-separator, sync-amplifier, keyed-age, or noise-suppressor tube. The pentode unit is used as a video-output tube. Outline 8D, OUTLINES SECTION. Tube requires miniature nine-contact socket and may be mounted in any position. Heater volts (ac/dc), 6.3; amperes, 0.72.

6DX8

Related type: 100X8

CLASS A₁ AMPLIFIER

Maximum Ratings, (Design-Center Values):

PLATE SUPPLY VOLTAGE.....	550 max	volts
PEAK PLATE VOLTAGE, with maximum plate current of 0.1 ma.....	600 max	volts
PLATE VOLTAGE.....	300 max	volts
GRID-NO.2 (SCREEN-GRID) SUPPLY VOLTAGE.....	550 max	volts
GRID-NO.2 VOLTAGE.....	300 max	volts
CATHODE CURRENT.....	12 max	ma
GRID-NO.2 INPUT.....	1.7 max	watts
PLATE DISSIPATION.....	1 max	watts
PEAK HEATER-CATHODE VOLTAGE:		
Heater negative with respect to cathode.....	200 max	volts
Heater positive with respect to cathode.....	200 max	volts

Triode

Characteristics:		
Plate Voltage.....	200	170
Grid-No.2 Voltage.....	170	200
Grid-No.1 Voltage.....	-1.7	-2.9
Amplification Factor.....	65	36
μ _p -Factor, Grid-No.2 to Grid-No.1.....	0.1	0.15
Plate Resistance (Approx.).....	4000	11000
Plate Current.....	3	18
Grid-No.2 Current.....	-	3

Typical Operation of Pentode Unit as Video Output Tube:

Plate Supply Voltage.....	170	200
Series Plate Resistor.....	3000	3000
Grid-No.2 Voltage.....	170	200
Grid-No.1 Voltage.....	-2	-3.3
Transconductance.....	10400	9700
Plate Current.....	18	18
Grid-No.2 Current.....	3.2	3.1

Maximum Circuit Values:

- Grid-No.1 Circuit Resistance:
 - For fixed-bias operation..... 1 maz megohm
 - For cathode-bias operation..... 3 maz 2 maz megohms
- With maximum duty factor of 0.18 and maximum pulse duration of 18 microseconds.

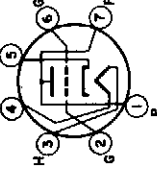

MEDIUM-MU TRIODE

Miniature type used as a local oscillator tube in uhf television receivers covering the frequency range from 470 to 890 megacycles. Outline 7A, OUTLINES SECTION. Tube requires miniature seven-contact socket and may be mounted in any position. For curve of average plate characteristics, refer to type 6AF4-A.

6DZ4

Related types: 2DZ4, 3DZ4

HEATER VOLTAGE (AC/DC).....	6.3	volts
HEATER CURRENT.....	0.225	ampere
DIRECT INTERELECTRODE CAPACITANCES (Approx.):		pf
Grid to Plate.....	1.8	pf
Plate to Cathode and Heater.....	2.2	pf
Plate to Cathode and Heater.....	1.3	pf

CLASS A₁ AMPLIFIER

Characteristics:

Plate Supply Voltage.....	80	volts
Plate Resistor.....	2700	ohms
Amplification Factor.....	14	
Plate Resistance (Approx.).....	2000	ohms
Transconductance.....	6700	μmhos
Plate Current.....	15	ma
Grid Voltage (Approx.) for plate current of 20 μa.....	-11	volts

UHF OSCILLATOR

Maximum Ratings, (Design-Maximum Values):

PLATE VOLTAGE.....	135 <i>max</i>	volts
GRID VOLTAGE, Negative-bias value.....	-50 <i>max</i>	volts
GRID CURRENT.....	2 <i>max</i>	ma
CATHODE CURRENT.....	20 <i>max</i>	ma
PEAK HEATER-CATHODE VOLTAGE: Heater negative with respect to cathode.....	50 <i>max</i>	volts
Heater positive with respect to cathode.....	50 <i>max</i>	volts

Typical Operation as Oscillator at 1000 Mc:

Plate Supply Voltage.....	135	volts
Plate-Circuit Resistance.....	2700	ohms
Grid Resistor.....	1000	ohms
Plate Current.....	15.5	ma
Grid Current (Approx.).....	300	μa

Maximum Circuit Values:

Grid-Circuit Resistance: For fixed-bias operation.....	Not recommended
For cathode-bias operation.....	0.5 <i>max</i> megohm

■ The dc component must not exceed 25 volts.

TWIN POWER PENTODE

Glass octal type used as power amplifier tube in high-fidelity audio equipment. Outline 19A, OUTLINES SECTION. Tube requires octal socket and may be operated in any position.

It is especially important that this tube, like other power-handling tubes, be adequately ventilated. Heater voltage (ac/dc), 6.3; amperes, 1.52.

6DZ7



CLASS A₁ AMPLIFIER

Characteristics, (Each Unit):

Plate Voltage.....	250	volts
Grid-No.2 (Screen-Grid) Voltage.....	250	volts
Grid-No.1 (Control-Grid) Voltage.....	7.8	volts
Plate Resistance (Approx.).....	80000	ohms
Transconductance.....	115000	μmhos
Plate Current.....	48	ma
Grid-No.2 Current.....	5.5	ma

PUSH-PULL CLASS AB₁ AMPLIFIER

Maximum Ratings, (Design-Maximum Values, Per Tube):

PLATE VOLTAGE.....	440 <i>max</i>	volts
GRID-No.2 VOLTAGE.....	300 <i>max</i>	volts
GRID-No.2 INPUT (Total).....	4 <i>max</i>	watts
PEAK HEATER-CATHODE VOLTAGE: Heater negative with respect to cathode.....	200 <i>max</i>	volts
Heater positive with respect to cathode.....	200 <i>max</i>	volts

Typical Operation, (Per Tube):

Plate Voltage.....	400	volts
Grid-No.2 Voltage.....	250	volts
Grid-No.1 Voltage.....	-11	volts
Cathode-Bias Resistor.....	120	ohms
Plate AF Grid-No.1-to-Grid-No.1 Voltage.....	22	volts

Zero-Signal Plate Current.....	40	ma
Maximum-Signal Plate Current.....	100	ma
Zero-Signal Grid-No.2 Current.....	4	ma
Maximum-Signal Grid-No.2 Current.....	13	ma
Effective Load Resistance (Plate-to-Plate).....	9000	ohms
Total Harmonic Distortion.....	2.5	per cent
Maximum-Signal Power Output.....	18	watts

Maximum Circuit Values, (Each Unit):

Grid-No.1-Circuit Resistance.....	0.27 <i>max</i>	megohm
-----------------------------------	-----------------	--------

• The dc component must not exceed 100 volts.

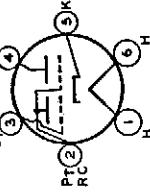

ELECTRON-RAY TUBE

Glass type used to indicate visually by means of a fluorescent target the effects of a change in a controlling voltage. It is used as a convenient means of indicating accurate radio-receiver tuning. Maximum dimensions: over-all length, 4-3/16 inches; seated height, 3-9/16 inches; diameter, 1-3/16 inches. Tube requires six-contact socket. Heater volts (ac/dc), 6.3; amperes, 0.3. For additional considerations, refer to *Tuning Indication with Electron-Ray Tubes* in ELECTRON TUBE APPLICATIONS SECTION.

6E5

Related types:
2E5

TUNING INDICATOR

Maximum and Minimum Ratings, (Design-Center Values):

PLATE-SUPPLY VOLTAGE.....	250 <i>max</i>	volts
TARGET VOLTAGE.....	{ 250 <i>max</i>	volts
	{ 125 <i>min</i>	volts

Typical Operation:

Plate and Target Supply Voltage.....	200	volts
Series Triode-Plate Resistor.....	1	megohm
Target Current*.....	3	ma
Triode-Plate Current*.....	0.19	ma
Triode-Grid Voltage (Approx.): For shadow angle of 9°.....	-6.5	volts
For shadow angle of 9°.....	0	volts

* For zero triode-grid voltage. † Subject to wide variations.

TWIN POWER TRIODE

Glass type used as class A₁ amplifier in either push-pull or parallel circuits. Outline 27, OUTLINES SECTION. Heater volts (ac/dc), 6.3; amperes, 0.6. With plate volts of 250 and grid volts of -27.5, characteristics for each unit are: plate ma., 18; plate resistance, 3500 ohms; transconductance, 1700 μmhos; amplification factor, 6. With plate-to-plate load resistance of 14000 ohms, output for two tubes is 1.6 watts. This is a DISCONTINUED type listed for reference only.

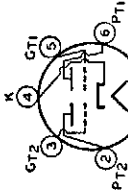

REMOTE-CUTOFF PENTODE

Glass type used in rf and if stages of radio receivers employing avc. Outline 24A, OUTLINES SECTION. Except for interelectrode capacitances, this type is identical electrically with type 6U7-G. Heater volts (ac/dc), 6.3; amperes, 0.3. This is a DISCONTINUED type listed for reference only.

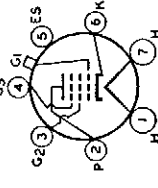

SHARP-CUTOFF TETRODE

Miniature type used as rf amplifier in vhf tuners of television receivers. Outline 7B, OUTLINES SECTION. Tube requires miniature seven-contact socket and may be operated in any position.

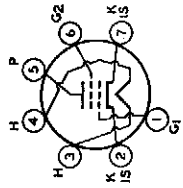

HEATER VOLTAGE (AC/DC).....
HEATER CURRENT.....

6EA5

Related type:
3EA5

6.3	volts
0.2	ampere

DIRECT INTERELECTRODE CAPACITANCES:

Grid No.1 to Plate	Without External Shield	With External Shield	pf
Grid No.1 to Cathode, Heater, Grid No.2, and Internal Shield	0.06 maz	0.05 maz	pf
Plate to Cathode, Heater, Grid No.2, and Internal Shield	3.8	4.5	pf
With external shield connected to cathode.	2.3	3	pf

CLASS A₁ AMPLIFIER

Maximum Ratings, (Design-Maximum Values):

PLATE VOLTAGE	250 maz	volts
GRID-NO.2 (SCREEN-GRID) VOLTAGE	150 maz	volts
GRID-NO.1 (CONTROL-GRID) VOLTAGE, Positive-bias value.	0 maz	volts
CATHODE CURRENT	20 maz	ma
GRID-NO.2 INPUT	0.5 maz	watt
PLATE DISSIPATION	3.25 maz	watts
PEAK HEATER-CATHODE VOLTAGE:		
Heater negative with respect to cathode	200 maz	volts
Heater positive with respect to cathode	200 ^m maz	volts

Characteristics:

Plate Voltage	250	volts
Grid-No.2 Voltage	140	volts
Grid-No.1 Voltage	-1	volt
Plate Resistance (Approx.)	0.15	megohm
Transconductance	8000	μmhos
Plate Current	10	ma
Grid-No.2 Current	0.95	ma
Grid-No.1 Voltage (Approx.) for transconductance of 100 μmhos or less	-6	volts

■ The dc component must not exceed 100 volts.

DUAL TRIODE

Glass octal type containing high-mu triode and high-perveance, low-mu triode in same envelope. Used as a combined vertical deflection oscillator and vertical deflection amplifier in television receivers. Outline 14B, OUTLINES SECTION. Tube requires octal socket and may be operated in any position. Heater volts (ac/dc), 6.3; amperes, 1.05.

6EA7

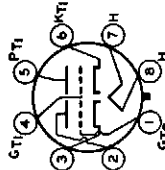

CLASS A₁ AMPLIFIER

Characteristics:	Unit No.1	Unit No.2	
Plate Voltage	250	60	175
Grid Voltage	-3	0	-25
Amplification Factor	66	0	5.5
Plate Resistance (Approx.)	30000	-	920
Transconductance	2200	-	6000
Grid Voltage (Approx.):			
For plate current of 20 μa	-5.3	-	-45
For plate current of 200 μa	2	100*	40
Plate current			

VERTICAL-DEFLECTION OSCILLATOR AND AMPLIFIER

For operation in a 525-line, 30-frame system

Maximum Ratings, (Design-Maximum Values):	Unit No.1	Unit No.2
DC PLATE VOLTAGE	Oscillator	Amplifier
PEAK POSITIVE-PULSE PLATE VOLTAGE*	350 maz	150 maz
PEAK NEGATIVE-PULSE GRID VOLTAGE	-400 maz	250 maz
PEAK CATHODE CURRENT	- maz	175 maz
AVERAGE CATHODE CURRENT	1 maz	50 maz
PLATE DISSIPATION	1 maz	10 maz
PEAK HEATER-CATHODE VOLTAGE:		
Heater negative with respect to cathode	200 maz	200 maz
Heater positive with respect to cathode	200 ^m maz	200 ^m maz
Maximum Circuit Values:		
Grid-Circuit Resistance:	1 maz	1 maz
For grid-resistor-bias operation	2.2 maz	2.2 maz
For cathode-bias operation		

* The duration of the voltage pulse must not exceed 15 per cent of one vertical scanning cycle. In a 525-line, 30-frame system, 15 per cent of one vertical scanning cycle is 2.5 milliseconds.
 ■ The dc component must not exceed 100 volts.

MEDIUM-MU TRIODE—SHARP-CUTOFF PENTODE

Miniature type used as combined oscillator and mixer in television receivers utilizing an intermediate frequency in the order of 40 megacycles per second. Outline 8B, OUTLINES SECTION. Tube requires miniature nine-contact socket and may be mounted in any position.

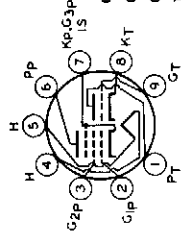

6EA8

Related types: 5EA8, 19EA8

any position.

HEATER VOLTAGE (AC/DC)	6.3	volts
HEATER CURRENT	0.45	ampere
HEATER WARM-UP TIME (Average)	11	seconds
DIRECT INTERELECTRODE CAPACITANCES:		
Triode Unit:	Without External Shield	With External Shield
Grid to Plate	1.7	1.7
Grid to Cathode, Heater, Pentode Cathode, Pentode Grid No.3, and Internal Shield	3	3.2
Plate to Cathode, Heater, Pentode Cathode, Pentode Grid No.3, and Internal Shield	1.4	1.9
Cathode to Heater	3	3*
Pentode Unit:		
Grid No.1 to Plate	0.02 maz	0.01 maz
Grid No.1 to Cathode, Heater, Grid No.2, Grid No.3, and Internal Shield	5	5
Plate to Cathode, Heater, Grid No.2, Grid No.3, and Internal Shield	2.6	3.4
Heater to Cathode	3	3*

* With external shield connected to cathode of unit under test except as noted.
 ■ With external shield connected to ground.

CLASS A₁ AMPLIFIER

Maximum Ratings, (Design-Maximum Values):

PLATE VOLTAGE	Triode Unit	Pentode Unit
GRID-NO.2 (SCREEN-GRID) SUPPLY VOLTAGE	330 maz	330 maz
GRID-NO.2 VOLTAGE	-	330 maz
GRID-NO.1 (CONTROL-GRID) VOLTAGE, Positive-bias value	0 maz	See curve page 70
PLATE DISSIPATION	2.5 maz	0 maz
GRID-NO.2 INPUT:		
For grid-No.2 voltages up to 165 volts	-	0.55 maz
For grid-No.2 voltages between 165 and 330 volts	-	See curve page 70
PEAK HEATER-CATHODE VOLTAGE:		
Heater negative with respect to cathode	200 maz	200 maz
Heater positive with respect to cathode	200 ^m maz	200 ^m maz

* The dc component must not exceed 100 volts.

AVERAGE PLATE CHARACTERISTICS

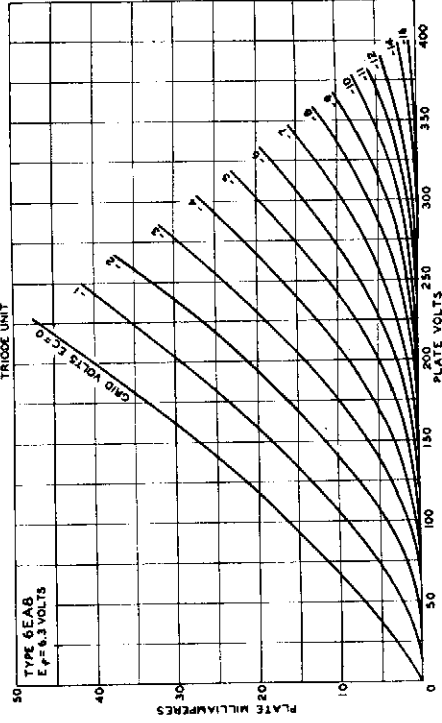

Characteristics:

Plate Supply Voltage.....	Triode Unit	Pentode Unit	volts
Grid-No.2 Voltage.....	150	125	volts
Grid-No.1 Voltage.....	—	125	volts
Cathode-Bias Resistor.....	56	—	ohms
Amplification Factor.....	40	—	ohms
Plate Resistance (Approx.).....	5000	200000	ohms
Transconductance.....	3500	6400	amhos
Plate Current.....	18	12	ma
Grid-No.2 Current.....	—	4	ma
Grid-No.1 Voltage for plate current of 10 μ a.....	-12	-9	volts

AVERAGE CHARACTERISTICS

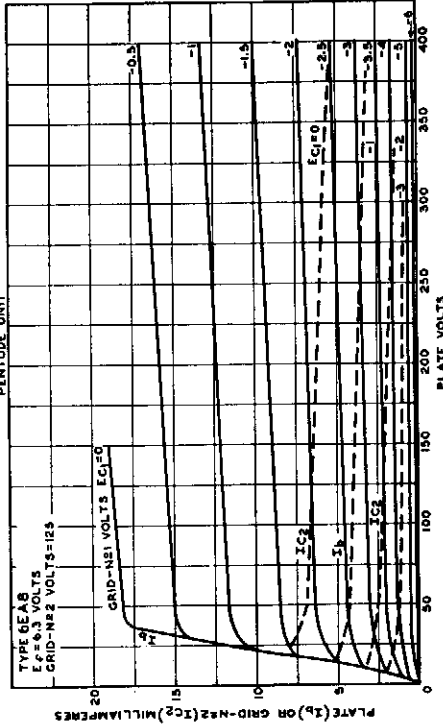

92CM-9907T

6EB8
SHARP-CUTOFF PENTODE

Miniature type used in color and black-and-white television receivers. Pentode unit is used as video output amplifier; triode unit is used in sync-separator, sync-clipper, and phase-inverter circuits. Outline 8D, OUTLINES SECTION. Tube requires miniature nine-contact socket and may be mounted in any position.

HEATER VOLTAGE (AC/DC).....	6.3	volts
HEATER CURRENT.....	0.75	ampere
DIRECT INTERELECTRODE CAPACITANCES:		
Triode Unit:		
Grid to Plate.....	4.4	pf
Grid to Cathode and Heater.....	2.4	pf
Plate to Cathode and Heater.....	0.36	pf
Pentode Unit:		
Grid No.1 to Plate.....	0.1 m μ F	
Grid No.1 to Cathode, Heater, Grid No.2, Grid No.3, and Internal Shield.....	1.1	pf
Plate to Cathode, Heater, Grid No.2, Grid No.3, and Internal Shield.....	4.2	pf
Triode Grid to Pentode Plate.....	0.018 m μ F	
Pentode Grid No.1 to Triode Plate.....	0.005 m μ F	
Pentode Plate to Triode Plate.....	0.17 m μ F	

CLASS A₁ AMPLIFIER

Maximum Ratings, (Design-Maximum Values):		
Plate Voltage.....	Pentode Unit	volts
Grid-No.2 (SCREEN-GRID) SUPPLY VOLTAGE.....	330 maz	volts
Grid-No.2 VOLTAGE.....	330 maz	volts
Grid-No.1 (CONTROL-GRID) VOLTAGE, Positive-bias value.....	See curve page 70	
Plate Dissipation.....	0 maz	volts
	1 maz	watts

AVERAGE PLATE CHARACTERISTICS

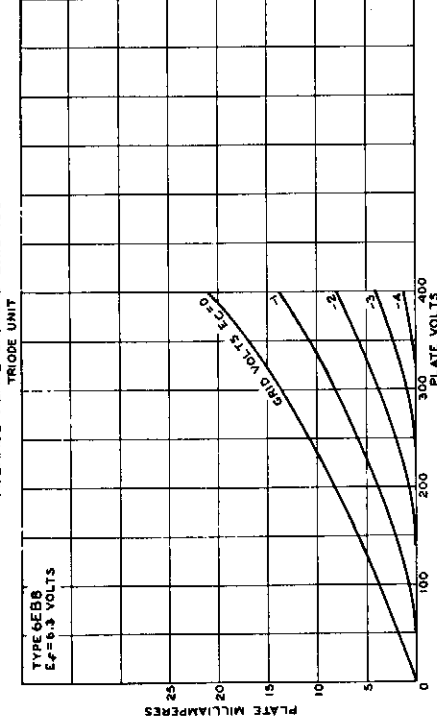

92CM-9907T

GRID-NO.2 INPUT:

For grid-No.2 voltages up to 165 volts.
 For grid-No.2 voltages between 165 and 330 volts.....
PEAK HEATER-CATHODE VOLTAGE:
 Heater negative with respect to cathode.....
 Heater positive with respect to cathode.....
 * The dc component must not exceed 100 volts.

Characteristics:

Plate Supply Voltage.....	Triode Unit	Pentode Unit	volts
Grid-No.2 Supply Voltage.....	250	200	volts
Grid Voltage.....	—	125	volts
Cathode-Bias Resistor.....	-2	—	ohms
Amplification Factor.....	100	68	ohms
Plate Resistance (Approx.).....	37000	75000	ohms
Transconductance.....	2700	12500	amhos
Grid Voltage (Approx.) for plate current of 20 μ a.....	-6	-9	volts
Grid-No.1 Voltage (Approx.) for plate current of 100 μ a.....	—	-25	ma
Plate Current.....	2	7	ma
Grid-No.2 Current.....	—	—	ma

Maximum Circuit Values:

Grid-No.1-Circuit Resistance:	0.5 maz	0.25 maz	megohm
For fixed-bias operation.....	1.0 maz	1.0 maz	megohm
For cathode-bias operation.....			

AVERAGE CHARACTERISTICS

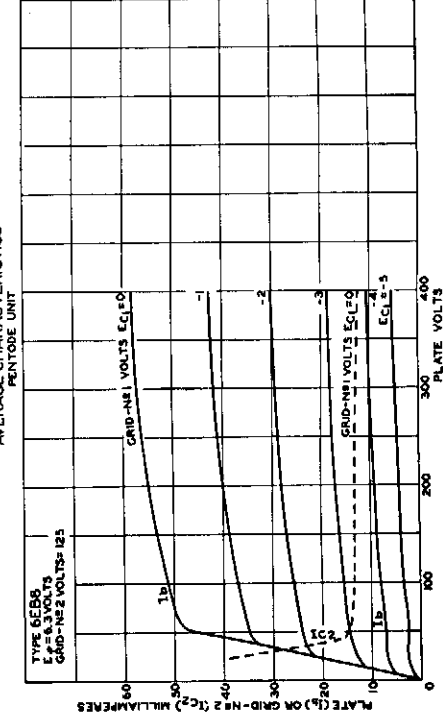

92CM-9908T

POWER PENTODE

Miniature type used in the audio output stage of radio and television receivers and in phonographs. This type has unusually high power sensitivity and is capable of providing relatively high power output at low plate and screen-grid voltages with a low of grid-No.1 driving voltage. Outline 7C, OUTLINES SECTION. Tube requires miniature seven-contact socket and may be mounted in any position.

6EH5

Related types:
12EH5, 25EH5, 50EH5

HEATER VOLTAGE (AC/DC)	6.3	volts
HEATER CURRENT	1.2	amperes
DIRECT INTERELECTRODE CAPACITANCES (Approx.):		
Grid No.1 to Plate	0.65	pf
Grid No.1 to Cathode, Heater, Grid No.2, and Grid No.3	17	pf
Plate to Cathode, Heater, Grid No.2, and Grid No.3	9	pf

CLASS A₁ AMPLIFIER

Maximum Ratings, (Design-Maximum Values):

PLATE VOLTAGE	150	max	volts
GRID-NO.2 (SCREEN-GRID) VOLTAGE	180	max	volts
PLATE DISSIPATION	5.5	max	watts
GRID-NO.2 INPUT	2	max	watts
PEAK HEATER-CATHODE VOLTAGE:			
Heater negative with respect to cathode	200	max	volts
Heater positive with respect to cathode	200	max	volts
BULB TEMPERATURE (At hottest point)	220	max	°C
Typical Operation:			
Plate Supply Voltage	110	volts	
Grid-No.2 Supply Voltage	115	volts	
Cathode-Bias Resistor	62	ohms	
Peak AF Grid-No.1 Voltage	3	volts	
Zero-Signal Plate Current	42	ma	
Maximum-Signal Plate Current	42	ma	
Zero-Signal Grid-No.2 Current	11.5	ma	
Maximum-Signal Grid-No.2 Current	14.5	ma	
Plate Resistance (Approx.)	11000	ohms	
Load Resistance	14800	ohms	
Total Harmonic Distortion	3000	μmhos	
Maximum-Signal Power Output	7	per cent	
Maximum Circuit Values:			
Grid-No.1-Circuit Resistance:			
For fixed-bias operation	0.1	max	megohm
For cathode-bias operation	0.5	max	megohm

* The dc component must not exceed 100 volts.

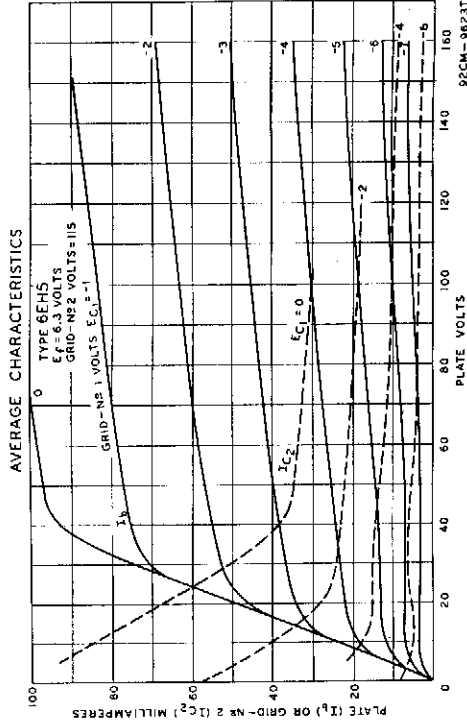

PUSH-PULL CLASS AB₁ AUDIO-FREQUENCY POWER AMPLIFIER

Maximum Ratings: (Same as for class A₁ audio-frequency power amplifier)

Typical Operation, (Values are for 2 tubes):			
Plate Supply Voltage	140	volts	
Grid-No.2 Supply Voltage	120	volts	
Cathode-Bias Resistor	68	ohms	
Peak AF Grid-No.1 Voltage	9.4	volts	
Zero-Signal Plate Current	47	ma	
Maximum-Signal Plate Current	51	ma	
Zero-Signal Grid-No.2 Current	11	ma	
Maximum-Signal Grid-No.2 Current	17.7	ma	
Effective Load Resistance (Plate-to-plate)	6000	ohms	
Total Harmonic Distortion	5	per cent	
Maximum-Signal Power Output	3.8	watts	
Maximum Circuit Values:			
Grid-No.1-Circuit Resistance:			
For fixed-bias operation	0.1	max	megohm
For cathode-bias operation	0.5	max	megohm

SEMIREMOTE-CUTOFF PENTODE

Miniature type used as if-amplifier tube in television receivers. Outline 8C, OUTLINES SECTION. Tube requires nine-contact socket and may be mounted in any position. Heater volts (ac/dc), 6.3; amperes, 0.3.

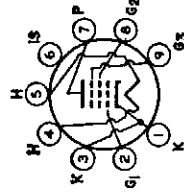

6EH7

Related types:
3EH7, 4EH7

CLASS A₁ AMPLIFIER

Maximum Ratings, (Design-Center Values):

PLATE SUPPLY VOLTAGE	550	max	volts
PLATE VOLTAGE	250	max	volts
GRID-NO.3 (SUPPRESSOR-GRID) VOLTAGE, Positive value	0	max	volts
GRID-NO.2 (SCREEN-GRID) SUPPLY VOLTAGE	550	max	volts
GRID-NO.2 VOLTAGE	250	max	volts
CATHODE CURRENT	20	max	ma
GRID-NO.2 INPUT	0.65	max	watt
PLATE DISSIPATION	2.5	max	watts
PEAK HEATER-CATHODE VOLTAGE:			
Heater negative with respect to cathode	150	max	volts
Heater positive with respect to cathode	150	max	volts

Characteristics:

Plate Voltage	200	volts
Grid No.3	Connected to cathode at socket	
Grid-No.2 Voltage	90	volts
Grid-No.1 Voltage	-2	volts
Plate Resistance (Approx.)	0.5	megohm
Transconductance	12500	μmhos
Plate Current	12	ma
Grid-No.2 Current	4.5	ma

Typical Operation:

Plate Voltage	200	200	200	200	volts
Grid No.3	Connected to cathode at socket				
Grid-No.2 Supply Voltage	200	200	200	200	volts
Grid-No.2 Series Resistor	22000	22000	22000	22000	ohms
Grid-No.1 Voltage	-19.5	-9.5	-6.5	-2	volts
Transconductance	125	625	1250	12500	μmhos
RMS Grid-No.1 Voltage, for cross-modulation factor of 0.01	450	160	100	-	mv

Maximum Circuit Values:

Grid-No.1-Circuit Resistance	1	max	megohm
------------------------------	---	-----	--------

DUAL TRIODE

Glass octal type containing high-mu triode and high-pervance, low-mu triode in same envelope. Used as combined vertical-deflection amplifier and vertical-deflection oscillator in television receivers employing picture tubes having 110-degree deflection angles and high ulior voltages. Outline 14A, OUTLINES SECTION. Tube requires octal socket and may be mounted in any position. For curve of average plate characteristics, Unit No.1, refer to type 6DR7 (Unit No.1).

6EM7

Related types:
10EM7, 13EM7

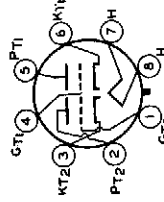

HEATER VOLTAGE (AC/DC)	6.3 volts
HEATER CURRENT	0.925 ampere
DIRECT INTERELECTRODE CAPACITANCES (Approx.):	
Grid to Plate	Unit No.1 4.8 pf
Grid to Cathode and Heater	2.2 pf
Plate to Cathode and Heater	0.6 pf

CLASS A₁ AMPLIFIER

Characteristics:	
Plate Voltage	Unit No.1 250 volts
Grid Voltage	-3 volts
Amplification Factor	64
Plate Resistance (Approx.)	40000 ohms
Transconductance	1800 μ mhos
Grid Voltage (Approx.):	
For plate current of 10 μ a	-5.5 volts
For plate current of 100 μ a	1.4 volts
Plate Current	For plate voltage of 60 volts and zero grid voltage
Plate Current, for grid voltage of -28 volts	1.4 ma
Plate Current, for grid voltage of -28 volts	95 ma
Plate Current, for grid voltage of -28 volts	10 ma

* The duration of the voltage pulse must not exceed 15 per cent of one vertical-scanning cycle. In a 525-line, 30-frame system, 15 per cent of one vertical-scanning cycle is 2.5 milliseconds.

† The dc component must not exceed 100 volts.

VERTICAL-DEFLECTION OSCILLATOR AND AMPLIFIER

For operation in a 525-line, 30-frame system

Maximum Ratings, (Design-Maximum Values):	
DC PLATE VOLTAGE	Unit No.2 350 volts
PEAK POSITIVE-PULSE PLATE VOLTAGE†	330 volts
PEAK NEGATIVE-PULSE GRID VOLTAGE	400 mazz
PEAK CATHODE CURRENT	27 mazz
AVERAGE CATHODE CURRENT	12 mazz
PLATE DISSIPATION	1.5 mazz
PEAK HEATER-CATHODE VOLTAGE	200 mazz
Heater negative with respect to cathode	200 mazz
Heater positive with respect to cathode	200 mazz

AVERAGE PLATE CHARACTERISTICS

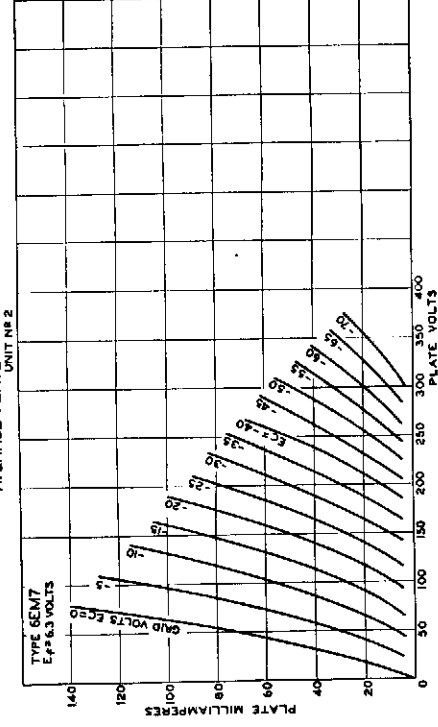

92CM-10466T

Maximum Circuit Values:
Grid-Circuit Resistance:
For grid-resistor-bias operation.....
For cathode-bias operation.....

Unit No.1
2.2 mazz
2.2 mazz

Unit No.2
2.2 mazz megohms
2.2 mazz megohms

**DIODE—REMOTECUTOFF
PENTODE**

Miniature type used as combined if amplifier and AM detector in AM and AM/FM radio receivers. Outline 8D, OUTLINES SECTION. Tube requires miniature nine-contact socket and may be operated in any position.

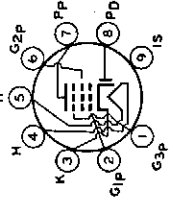

6EQ7

Related types:
12EQ7, 20EQ7

HEATER VOLTAGE (AC/DC)	6.3 volts
HEATER CURRENT	0.3 ampere
DIRECT INTERELECTRODE CAPACITANCES:	
Pentode Unit:	
Grid No.1 to Plate	0.002 mazz
Plate to Cathode; Heater, Grid No.2, Grid No.3, and Internal Shield	5.5 pf
Pentode Grid No.1 to Diode Plate	0.0015 mazz
Pentode Plate to Diode Plate	0.095 pf

PENTODE UNIT AS CLASS A₁ AMPLIFIER

Maximum Ratings, (Design-Maximum Values):

PLATE VOLTAGE	300 mazz
Grid-No.3 (SUPPRESSOR-GRID) VOLTAGE:	
Positive value	300 mazz
Negative value	-300 mazz
Grid-No.2 (SCREEN-GRID) SUPPLY VOLTAGE	300 mazz
Grid-No.2 VOLTAGE	See curve page 70
Grid-No.1 (CONTROL-GRID) VOLTAGE:	
Positive-bias value	0 mazz
Negative-bias value	-50 mazz
PLATE DISSIPATION	3 mazz
Grid-No.3 INPUT	0.2 mazz
Grid-No.2 INPUT	0.6 mazz
For grid-No.2 voltages up to 150 volts	See curve page 70
For grid-No.2 voltages between 150 and 300 volts	See curve page 70
PEAK HEATER-CATHODE VOLTAGE:	
Heater negative with respect to cathode	200 mazz
Heater positive with respect to cathode	200 mazz
BULB TEMPERATURE (At hottest point)	150 mazz

Characteristics:

Plate Voltage	100 volts
Grid No.3	Connected to cathode at socket
Internal Shield	Connected to cathode at socket
Grid-No.2 Voltage	100 volts
Grid-No.1 Supply Voltage	0
Grid-No.1 Resistor (Bypassed)	2.2 megohms

AVERAGE CHARACTERISTICS

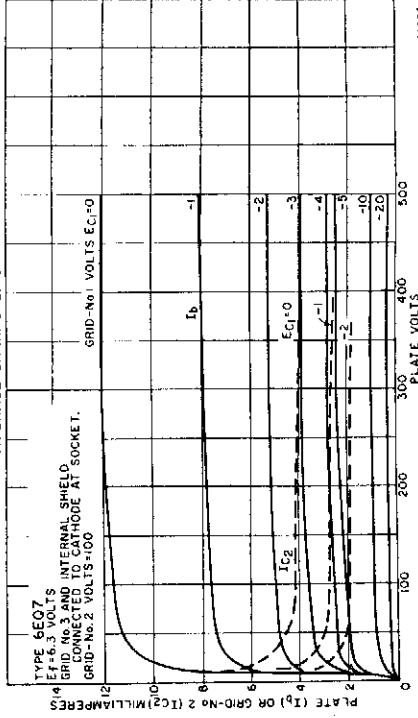

92V-6451C

Plate Resistance (Approx.)	0.25 megohm
Transconductance	3800 μ mhos
Plate Current	9 ma
Grid-No.2 Current	3.5 ma
Grid-No.1 Voltage (Approx.) for transconductance of 40 μ mhos	-20 volts

DIODE UNIT

Maximum Ratings, (Design-Maximum Values):	
PLATE CURRENT	1 maz
PLATE VOLTAGE	10 volts

Characteristics, Instantaneous Value:

Tube Voltage Drop for plate current of 2 ma.
 * The dc component must not exceed 100 volts.

HIGH-MU TRIODE

Miniature type with frame grid used in vhf tuners of television receivers. Outline 7B, OUTLINES SECTION. Tube requires miniature seven-contact socket and may be mounted in any position. Heater volts (ac/dc), 6.3, amperes, 0.18.

6ER5

Related types:
 2ER5, 3ER5

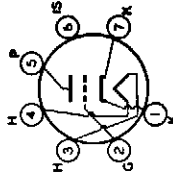

Maximum Ratings, (Design-Center Values):

PLATE VOLTAGE	250 maz
GRID VOLTAGE, Negative-bias value	-50 maz
CATHODE CURRENT	20 maz
PLATE DISSIPATION	2.2 maz watts
PEAK HEATER-CATHODE VOLTAGE:	
Heater negative with respect to cathode	100 maz volts
Heater positive with respect to cathode	100 maz volts

Characteristics:

Plate Voltage	200 volts
Grid Voltage	-1.2 volts
Amplification Factor	80
Plate Resistance (Approx.)	8000 ohms
Transconductance	10500 μ mhos
Plate Current	10 ma
Grid Voltage (Approx.) for transconductance of 500 μ mhos	-3.8 volts
Grid Voltage (Approx.) for transconductance of 100 μ mhos	-5.6 volts

Maximum Circuit Values:

Grid-Circuit Resistance	1 maz megohm
-------------------------	--------------

HIGH-MU TRIODE

Miniature type used as grounded-cathode rf amplifier in vhf television receivers. Outline 7B, OUTLINES SECTION. Tube requires miniature seven-contact socket and may be operated in any position. Heater volts (ac/dc), 6.3; amperes, 0.2.

6ES5

CLASS A₁ AMPLIFIER

Maximum Ratings, (Design-Maximum Values):	
PLATE VOLTAGE	250 maz volts
GRID VOLTAGE, Positive-bias value	0 maz volts
CATHODE CURRENT	22 maz ma
PLATE DISSIPATION	2.2 maz watts
PEAK HEATER-CATHODE VOLTAGE:	
Heater negative with respect to cathode	100 maz volts
Heater positive with respect to cathode	100 maz volts

Characteristics:

Plate Voltage	200 volts
Grid Voltage	7 volts
Amplification Factor	75
Plate Resistance (Approx.)	8000 ohms
Transconductance	9000 μ mhos
Plate Current	10 ma
Grid Voltage (Approx.) for plate current of 100 μ a	-6 volts

Maximum Circuit Values:

Grid-Circuit Resistance	1 maz megohm
-------------------------	--------------

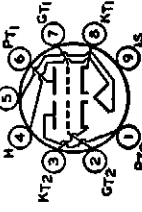

VARIABLE-MU TWIN TRIODE

Miniature type with high transconductance, variable mu, and low noise; used as cascode-type amplifier in tuners of television receivers. Outline 8B, OUTLINES SECTION. Tube requires miniature nine-contact socket and may be operated in any position. Heater volts (ac/dc), 6.3; amperes, 0.366.

6ES8

Related type:
 4ES8

CLASS A₁ AMPLIFIER (Each Unit)

Characteristics:	
Plate Voltage	90 volts
Grid Voltage	-1.2 volts
Plate Resistance (Approx.)	2500 ohms
Transconductance	12500 μ mhos
Plate Current	15 ma

CASCODE-TYPE AMPLIFIER

Maximum Ratings, (Design-Center Values):	
PLATE SUPPLY VOLTAGE with plate current of 0 ma	550 maz volts
PLATE VOLTAGE (Each unit)	130 maz volts
GRID VOLTAGE, Negative-bias value (Each unit)	-50 maz volts
CATHODE CURRENT (Each unit)	22 maz ma
PLATE DISSIPATION (Each unit)	1.8 maz watts
HEATER-CATHODE VOLTAGE:	
Unit No.1	50 maz volts
Unit No.2	50 maz volts
RMS voltage between cathode and heater*	130 maz volts
DC voltage between cathode and heater*	130 maz volts

Typical Operation: In a cascode-type circuit with the grid of the output unit connected to a voltage divider

Supply Voltage	180 volts
Plate Current	15 ma
Transconductance	12500 μ mhos
Noise Figure*	6.5 db
Grid Voltage (Approx.) for transconductance of 125 μ mhos	-9 volts
Input Voltage for cross-modulation factor of 0.01 and transconductance of 125 μ mhos	500 mv

Maximum Circuit Values:

Grid-Circuit Resistance (Each unit)	1 maz megohm
-------------------------------------	--------------

- ° Grounded-cathode input unit—pins 6, 7, and 8.
- Grounded-grid output unit—pins 1, 2, and 3.
- ▲ Cathode positive with respect to heater.

In order not to exceed the maximum-rated plate voltage when the cascode-type amplifier is controlled it is necessary to use a voltage divider for the grid of the grounded-grid output unit.
 * Measured with tube operating in a television tuner.

HIGH-MU TWIN TRIODE

Miniature type used in high-gain, resistance-coupled, low-level audio-amplifier applications where low-hum and non-microphonic characteristics are important considerations, such as in microphone amplifiers and in preamplifiers for mono- and stereophonic phonographs. Outline 8B, OUTLINES SECTION. Tube requires miniature nine-contact socket and may be mounted in any position. For typical operation as a resistance-coupled amplifier, refer to RESISTANCE-COUPLED AMPLIFIER SECTION.

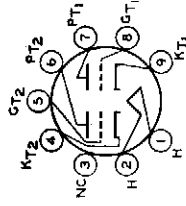

6EU7

HEATER VOLTAGE (AC/DC)	6.3 volts
HEATER CURRENT	0.3 ampere
DIRECT INTERELECTRODE CAPACITANCES (Each Unit, Approx.):	
Grid to Plate	1.5 pf
Grid to Cathode and Heater	1.6 pf
Plate to Cathode and Heater	0.2 pf

EQUIVALENT NOISE AND HUM VOLTAGE (Referenced to Grid, Each Unit):

- Average Value* 1.8 microvolts rms
- * Measured in "true rms" units under the following conditions: Heater volts (ac), 6.3; center-tap of heater transformer grounded; plate supply volts, 250; plate load resistor, 100000 ohms; cathode resistor, 2700 ohms; cathode bypass capacitor, 100 μ i; grid resistor, 0 ohms; amplifier frequency range, 25 to 10000 cps.

CLASS A₁ AMPLIFIER (Each Unit)

- Maximum Ratings, (Design-Maximum Values):**
- PLATE VOLTAGE 380 max volts
 - GRID VOLTAGE -55 max volts
 - Grid No. 1 Voltage 0 max volts
 - Grid No. 2 Voltage 1.2 max volts
 - PLATE DISSIPATION 200 mwr watts
 - PEAK HEATER-CATHODE VOLTAGE 200 mwr volts
 - Heater negative with respect to cathode 200[#] max volts
 - Heater positive with respect to cathode

The dc component must not exceed 100 volts.

Characteristics:

- Plate Voltage 100 volts
- Grid Voltage -1 volts
- Amplification Factor 100
- Plate Resistance (Approx.) 80000 ohms
- Transconductance 1250 μ mhos
- Plate Current 0.5 ma

AVERAGE PLATE CHARACTERISTICS

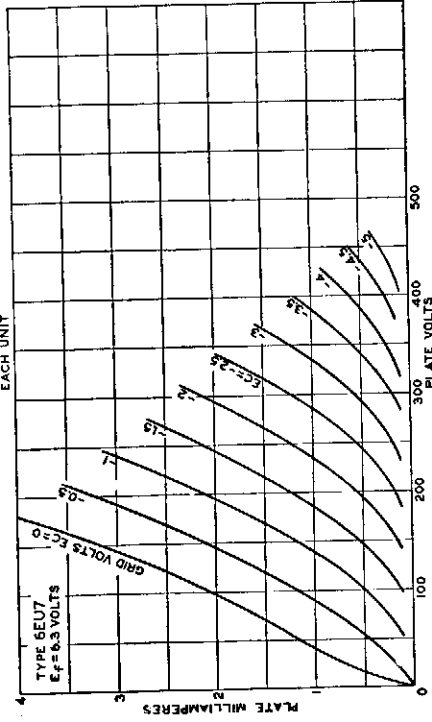

MEDIUM-MU TRIODE—SHARP-CUTOFF PENTODE

Miniature type used as combined μ T triode oscillator and pentode mixer in television receivers. Outline 8B, OUTLINES SECTION. Tube requires miniature nine-contact socket and may be operated in any position. Heater volts (ac/dc), 6.3; amperes, 0.45; warm-up time (average), 11 seconds.

6E8

Related type: 5E8

CLASS A₁ AMPLIFIER

- Maximum Ratings, (Design-Center Values):**
- PLATE VOLTAGE 380 max volts
 - GRID-NO.2 (SCREEN-GRID) SUPPLY VOLTAGE 380 max volts
 - GRID-NO.1 (CONTROL-GRID) VOLTAGE, Positive-bias value 0 max volts
 - PLATE DISSIPATION 3 mwr watts

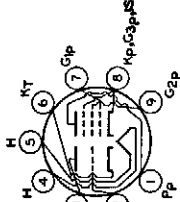

- GRID-NO.2 INPUT: 0.55 max watt
- For grid-No.2 voltages up to 165 volts. See curve page 70
- For grid-No.2 voltages between 165 and 380 volts.
- PEAK HEATER-CATHODE VOLTAGE: 200 max volts
- Heater negative with respect to cathode. 200[#] max volts
- Heater positive with respect to cathode.

Characteristics:

- Plate Supply Voltage 150 volts
- Grid-No.2 Supply Voltage 125 volts
- Grid-No.1 Voltage -1 volt
- Cathode-Bias Resistor 56 ohms
- Amplification Factor 40
- Plate Resistance (Approx.) 5000 ohms
- Transconductance 8500 μ mhos
- Grid-No.1 Voltage (Approx.) for plate current of 10 μ a -12 ma
- Plate Current 18 ma
- Grid-No.2 Current 4 ma
- Cathode Warm-up Time* 35 seconds

Maximum Circuit Values:

- Grid-No.1-Circuit Resistance 0.1 max megohm
- * The dc component must not exceed 100 volts.
- The cathode warm-up time is defined as the time required for the transconductance to reach 6500 μ mhos when the tube is operated from a cold start with dc plate volts=100, grid volts=0, and heater volts=5.5.

SHARP-CUTOFF TETRODE

Miniature type used as rf amplifier in vhf tuners of television receivers. Outline 7B, OUTLINES SECTION. Tube requires miniature seven-contact socket and may be operated in any position. Heater volts (ac/dc), 6.3; amperes, 0.2.

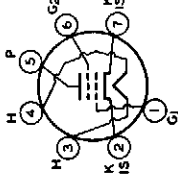

6EV5

CLASS A₁ AMPLIFIER

Maximum Ratings, (Design-Maximum Values):

- PLATE VOLTAGE 275 max volts
- GRID-NO.2 (SCREEN-GRID) SUPPLY VOLTAGE 180 max volts
- GRID-NO.1 VOLTAGE See curve page 70
- GRID-NO.1 (CONTROL-GRID) VOLTAGE, Positive-bias value 0 max volts
- CATHODE CURRENT 20 max ma
- GRID-NO.2 INPUT: 0.2 max watt
- For grid-No.2 voltages up to 90 volts. See curve page 70
- For grid-No.2 voltages between 90 and 180 volts. 3.25 max watts
- PLATE DISSIPATION 100 max volts
- PEAK HEATER-CATHODE VOLTAGE: 100[#] max volts
- Heater negative with respect to cathode
- Heater positive with respect to cathode

Characteristics:

- Plate Voltage 250 volts
- Grid-No.2 Voltage 50 volts
- Grid-No.1 Voltage 0.1 volt
- Plate Resistance (Approx.) 8800 megohms
- Transconductance 11.5 μ mhos
- Plate Current 0.9 ma
- Grid-No.2 Current 0.3 ma
- Grid-No.1 Voltage (Approx.) for transconductance of 100 μ mhos -4.5 volts

Maximum Circuit Value:

- Grid-No.1-Circuit Resistance 0.5 max megohm
- * The dc component must not exceed 50 volts.

HIGH-MU TWIN TRIODE

Miniature type used as a relay-control tube in remote-control tuning units of television receivers. It is processed specifically for operation under standby conditions. Outline 8D, OUTLINES SECTION. Tube requires miniature nine-contact socket and may be mounted in any position.

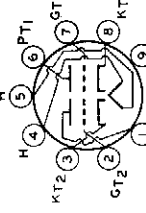

6EV7

HEATER VOLTAGE (AC/DC).....	6.3	volts
HEATER CURRENT.....	0.6	ampere
DIRECT INTERELECTRODE CAPACITANCES (APPROX.):		
Grid to Plate.....	Unit No.1 3.4	pf
Grid to Cathode and Heater.....	3	pf
Plate to Cathode and Heater.....	0.23	pf

CLASS A₁ AMPLIFIER (Each Unit)

Characteristics:		
Plate Voltage.....	250	volts
Grid Voltage.....	-2	volts
Amplification Factor.....	60	
Plate Resistance (Approx.).....	11500	ohms
Transconductance.....	5200	μmhos
Plate Current.....	9.2	ma
Grid Voltage (Approx.) for plate current of 100 μa.....	-9	volts

RELAY-CONTROL SERVICE (Each Unit)

Maximum Ratings, (Design-Maximum Values):		
PLATE VOLTAGE.....	300 maz	volts
GRID VOLTAGE, Positive-bias value.....	0 maz	volts
CATHODE CURRENT.....	20 maz	ma
PLATE DISSIPATION.....	2.5 maz	watts
When "on" time exceeds 30 seconds in any 2-minute interval.....	4.5 maz	watts
When "on" time does not exceed 30 seconds in any 2-minute interval.....	200 maz	volts
PEAK HEATER-CATHODE VOLTAGE.....	200* maz	volts
Heater negative with respect to cathode.....		
Heater positive with respect to cathode.....		

* The dc component must not exceed 100 volts.

Typical Operation with 2500-Ohm-Relay Load:

30 seconds
or less

With "on" time in any 2-minute interval:

Plate Supply Voltage.....	250	volts
Zero-bias Plate Current.....	18.3	ma
Grid Voltage (Approx.) for plate current of 100 μa.....	-9	volts

Maximum Circuit Value:		
Grid-Circuit Resistance.....	3.9 maz	megohms

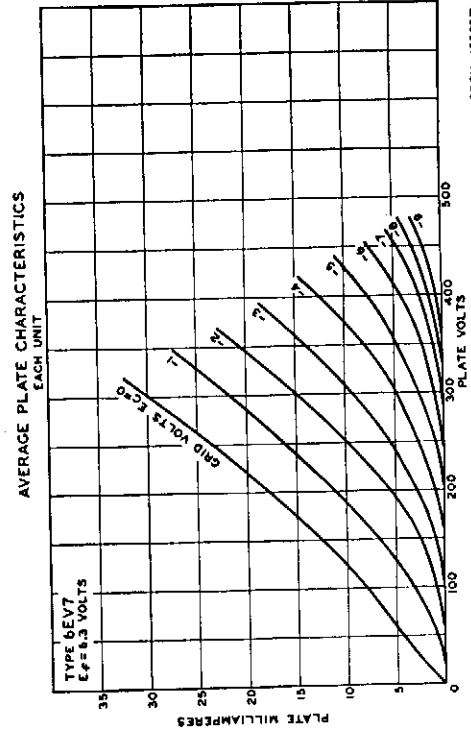

92CM-0593T

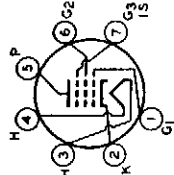

SHARP-CUTOFF PENTODE

Miniature type used in the gain-controlled picture-if stages of vhf television receivers operating at an intermediate frequency in the order of 40 megacycles per second. This tube features controlled plate-current cutoff and high transconductance (14000 μmhos)

6EW6

Related types:
4EW6, 5EW6

combined with low interelectrode capacitance values. The 6EW6 is provided with separate base pins for grid No.3 and cathode to permit the use of an unbypassed cathode resistor to minimize changes in input conductance and input capacitance with bias, without causing oscillation. Outline 7B, OUTLINES SECTION. Tube requires miniature seven-contact socket and may be mounted in any position.

HEATER VOLTAGE (AC/DC).....	6.3	volts
HEATER CURRENT.....	0.4	ampere
DIRECT INTERELECTRODE CAPACITANCES:		
Grid No.1 to Plate.....	Without External Shield* 0.04 maz	pf
Grid No.1 to Cathode, Heater, Grid No.2, Grid No.3 and Internal Shield.....	10	pf
Plate to Cathode, Heater, Grid No.2, Grid No.3, and Internal Shield.....	2.4	pf

CLASS A₁ AMPLIFIER

Maximum Ratings, (Design-Maximum Values):

PLATE VOLTAGE.....	330 maz	volts
GRID No.3 (SUPPRESSOR-GRID) VOLTAGE, Positive value.....	0 maz	volts
GRID-No.2 (SCREEN-GRID) SUPPLY VOLTAGE.....	330 maz	volts
GRID-No.2 VOLTAGE.....	See curve page 70	volts
GRID-No.1 (CONTROL-GRID) VOLTAGE, Positive-bias value.....	0 maz	volts
PLATE DISSIPATION.....	3.1 maz	watts
GRID-No.2 INPUT:		
For grid-No.2 voltages up to 165 volts.....	0.65 maz	watt
For grid-No.2 voltages between 165 and 330 volts.....	See curve page 70	volts

PEAK HEATER-CATHODE VOLTAGE:
Heater negative with respect to cathode.....
Heater positive with respect to cathode.....

Characteristics:		
Plate Supply Voltage.....	125	volts
Grid No.3.....	Connected to cathode at socket	
Grid-No.2 Supply Voltage.....	125	volts
Cathode-Bias Resistor.....	56	ohms
Plate Resistance (Approx.).....	0.2	megohm
Transconductance.....	14000	μmhos
Grid-No.1 Voltage (Approx.) for plate current of 20 μa.....	-3.5	volts
Plate Current.....	11	ma
Grid-No.2 Current.....	3.2	ma

* With external shield connected to cathode.
* The dc component must not exceed 100 volts.

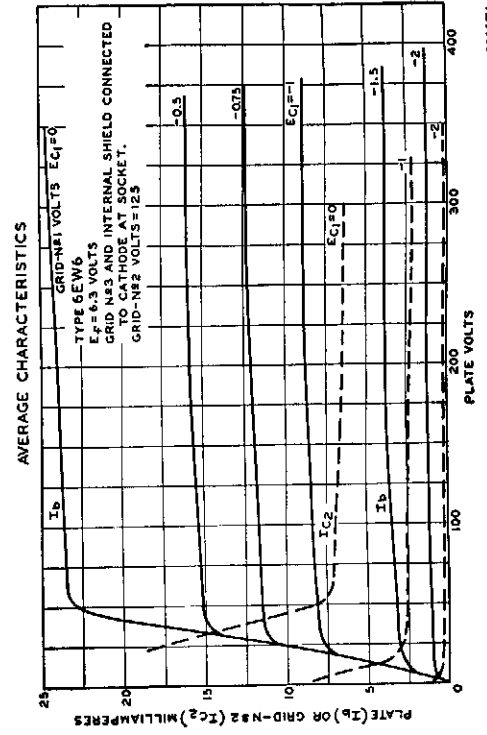

92CM-9945T

6EW7

DUAL TRIODE

Neonovial type used as combined vertical-deflection oscillator and vertical-deflection amplifier in television receivers. Outline 11B, OUTLINES SECTION. Tube requires neonovial plate characteristics, Unit No.1, refer to type 6DE7 (Unit No.1).

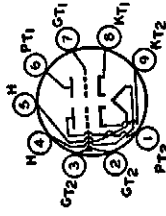

HEATER VOLTAGE (AC/DC)	6.3 volts
HEATER CURRENT	0.9 ampere
DIRECT INTERELECTRODE CAPACITANCES (Approx.):	
Grid to Plate	4.2 pf
Grid to Cathode and Heater	2.2 pf
Plate to Cathode and Heater	0.4 pf

CLASS A₁ AMPLIFIER

Characteristics:	
Plate Voltage	Unit No.1 250 volts
Grid Voltage	Unit No.1 -11 volts
Amplification Factor	Unit No.1 17.5
Plate Resistance (Approx.)	Unit No.1 8750 ohms
Transconductance	Unit No.1 2000 μmhos
Grid Voltage (Approx.) for plate current of 10 μA	Unit No.1 -20 volts
Grid Voltage (Approx.) for plate current of 100 μA	Unit No.1 -5.5 volts
Plate Current for plate voltage of 60 volts and zero grid voltage	Unit No.1 95 ma
Plate Current for grid voltage of -25 volts	Unit No.1 8 ma

VERTICAL-DEFLECTION OSCILLATOR AND AMPLIFIER

For operation in a 525-line, 30-frame system

Unit No. 1	Unit No. 2
Oscillator	Amplifier
330 max	330 max
DC PLATE VOLTAGE	380 max
PEAK POSITIVE-PULSE PLATE VOLTAGE*	1500 max
PEAK NEGATIVE-PULSE GRID VOLTAGE	-250 max
PEAK CATHODE CURRENT	77 max
AVERAGE CATHODE CURRENT	22 max
PLATE DISSIPATION	1.5 max
PEAK HEATER-CATHODE VOLTAGE:	200 max
Heater negative with respect to cathode	200*max
Heater positive with respect to cathode	

Maximum Circuit Values:

Grid-Circuit Resistance:	2.2 max
For cathode-bias operation	2.2 max
For grid-resistor-bias operation	2.2 max
For grid-resistor-bias operation	2.2 max
For cathode-bias operation	2.2 max
For grid-resistor-bias operation	2.2 max
For cathode-bias operation	2.2 max
For grid-resistor-bias operation	2.2 max
For cathode-bias operation	2.2 max
For grid-resistor-bias operation	2.2 max

AVERAGE CHARACTERISTICS

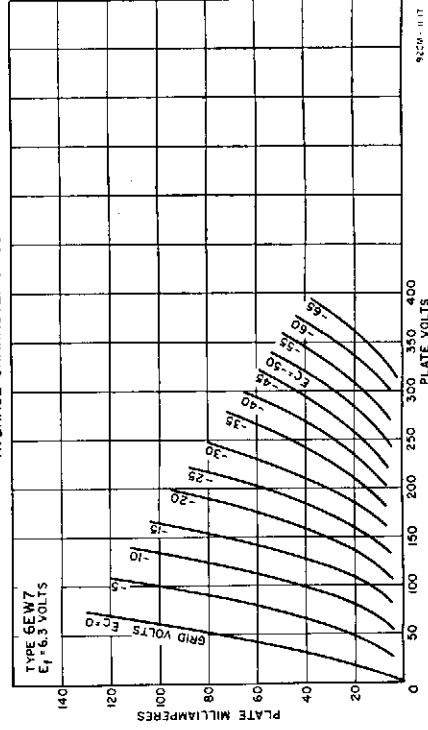

* The duration of the voltage pulse must not exceed 15 per cent of one vertical scanning cycle. In a 525-line, 30-frame system, 15 per cent of one vertical scanning cycle is 2.5 milliseconds.

• The dc component must not exceed 100 volts.

6EX6

Related type:
21EX6

BEAM POWER TUBE

Glass octal type used as horizontal deflection amplifier in television receivers. Outline 25A, OUTLINES SECTION. Tube requires octal socket and should be operated vertically (base down or up) or horizontally with pins 2 and 7 in a vertical plane. Heater volts (ac/dc) 6.3; amperes, 2.25. Characteristics as class A₁ amplifier: plate and grid-No.2 volts, 175; grid-No.1 volts, -30; triode amplification factor, 4.2; plate resistance (approx.), 8500 ohms; transconductance, 7700 μmhos; plate ma., 67; grid-No.2 ma., 3.3. Maximum ratings as horizontal-deflection amplifier: dc plate volts, 770 max; peak positive-pulse plate volts, 7000 max; peak negative-pulse plate volts, -1500 max; dc grid-No.2 volts, 195 max; peak negative-pulse grid-No.1 volts, -220 max; cathode ma., 770 max; peak heater-cathode volts, 200 max (the dc component must not exceed 100 volts). This type is used principally for renewal purposes.

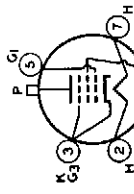

plate resistance (approx.), 8500 ohms; transconductance, 7700 μmhos; plate ma., 67; grid-No.2 ma., 3.3. Maximum ratings as horizontal-deflection amplifier: dc plate volts, 770 max; peak positive-pulse plate volts, 7000 max; peak negative-pulse plate volts, -1500 max; dc grid-No.2 volts, 195 max; peak negative-pulse grid-No.1 volts, -220 max; cathode ma., 770 max; peak heater-cathode volts, 200 max (the dc component must not exceed 100 volts). This type is used principally for renewal purposes.

BEAM POWER TUBE

Glass octal type used as vertical deflection amplifier in television receivers. Outline 14E, OUTLINES SECTION. Tube requires octal socket and may be operated in any position. Heater volts (ac/dc), 6.3; amperes, 0.68.



CLASS A₁ AMPLIFIER

Characteristics:	
Plate Voltage	50 volts
Grid-No.2 Voltage	250 volts
Grid-No.1 Voltage	0
Plate Resistance (Approx.)	—
Transconductance	—
Grid-No.1 Voltage (approx.) for plate current of 100 μA	153*
Plate Current	44 ma
Grid-No.2 Current	21*

VERTICAL DEFLECTION AMPLIFIER

For operation in a 525-line, 30-frame system

Maximum Ratings, (Design-Maximum Values):	
DC PLATE VOLTAGE	350 max
PEAK POSITIVE-PULSE PLATE VOLTAGE*	2500 max
GRID-No.2 (SCREEN-GRID) VOLTAGE	200 max
PEAK NEGATIVE-PULSE GRID-No.1 (CONTROL-GRID) VOLTAGE	-250 max
AVERAGE CATHODE CURRENT	180 max
PLATE DISSIPATION	60 max
GRID-No.2 INPUT	11 max
PEAK HEATER-CATHODE VOLTAGE:	2.75 max
Heater negative with respect to cathode	200 max
Heater positive with respect to cathode	200*max
BULB TEMPERATURE (At hottest point)	200 max

Maximum Circuit Values:

Grid-No.1-Circuit Resistance:	1 max
For fixed-bias operation	2.2 max
For cathode-bias operation	2.2 max
For cathode-bias operation	2.2 max
For cathode-bias operation	2.2 max
For cathode-bias operation	2.2 max
For cathode-bias operation	2.2 max
For cathode-bias operation	2.2 max
For cathode-bias operation	2.2 max
For cathode-bias operation	2.2 max
For cathode-bias operation	2.2 max

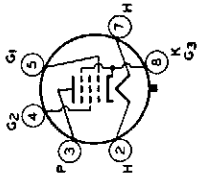

BEAM POWER TUBE

Glass octal type used as vertical deflection amplifier in television receivers. Outline 14E, OUTLINES SECTION. Tube requires octal socket and may be operated in any position. Heater volts (ac/dc), 6.3; amperes, 0.8.

6EZ5

CLASS A₁ AMPLIFIER

Characteristics:

Plate Voltage.....	250 volts
Grid-No.2 Voltage.....	250 volts
Grid-No.1 Voltage.....	0 volts
Plate Resistance (Approx.).....	50000 ohms
Transconductance.....	4100 μ hos
Grid-No.1 Voltage (Approx.) for plate current of 100 μ a.....	-43 volts
Plate Current.....	50 ma
Grid-No.2 Current.....	3.5 ma

VERTICAL DEFLECTION AMPLIFIER

For operation in a 525-line, 30-frame system

Maximum Ratings, (Design-Maximum Values):

DC PLATE VOLTAGE.....	350 maz
PEAK POSITIVE-PULSE PLATE VOLTAGE*.....	2500 maz
GRID-NO.2 (SCREEN-GRID) VOLTAGE.....	300 maz
PEAK NEGATIVE-PULSE GRID-NO.1 (CONTROL-GRID) VOLTAGE.....	-250 maz
PEAK CATHODE CURRENT.....	260 maz
AVERAGE CATHODE CURRENT.....	75 ma
PLATE DISSIPATION.....	12 maz
GRID-NO.2 INPUT.....	2.75 maz
PEAK HEATER-CATHODE VOLTAGE.....	200 maz
Heater negative with respect to cathode.....	200 μ maz
Heater positive with respect to cathode.....	200 maz
BULB TEMPERATURE (At hottest point).....	200 $^{\circ}$ C

Maximum Circuit Values:

Grid-No.1-Circuit Resistance.....	1 maz
For fixed-bias operation.....	megohm
For cathode-bias operation.....	2.2 maz
* This value can be measured by a method involving a recurrent waveform such that the maximum ratings of the tube will not be exceeded.	
o The duration of the voltage pulse must not exceed 15 per cent of one vertical scanning cycle. In a 525-line, 30-frame system, 15 per cent of one vertical scanning cycle is 2.5 milliseconds.	
■ The dc component must not exceed 100 volts.	

HIGH-MU TRIPLE TRIODE

Miniature type used in oscillator-mixer and afc service in FM receivers. Outline 8B, OUTLINES SECTION. Tube requires miniature nine-contact socket and may be operated in any position. Heater volts (ac/dc), 6.3; amperes, 0.45.

6EZ8

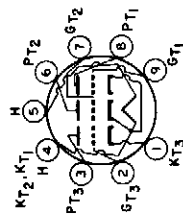

CLASS A₁ AMPIFIER (Each Unit Unless Otherwise Specified)

Maximum Ratings, (Design-Maximum Values):	
Grid Voltage.....	330 maz
Plate Voltage.....	330 maz
Negative-bias value.....	-50 maz
Plate Dissipation.....	0 maz
Total Plate Dissipation (All plates).....	2 maz
Heater-Cathode Voltage (Unit No.3):	5 maz
Heater negative with respect to cathode.....	100 maz
Heater positive with respect to cathode.....	100 maz
Characteristics:	
Plate Voltage.....	125 volts
Grid Voltage.....	57 volts
Amplification Factor.....	57
Plate Resistance (Approx.).....	18600 ohms
Transconductance.....	4200 μ hos
Grid Voltage (Approx.) for plate current of 20 μ a.....	-4 volts
Plate Current.....	4.2 ma

HIGH-MU TRIODE

Metal type 6F5 and glass octal type 6F5-GT used in resistance-coupled amplifier circuits. Outlines 3 and 15A, respectively, OUTLINES SECTION. Tubes require octal socket and may be mounted in any position. Type 6F5-GT may be supplied with pin No.1 omitted.

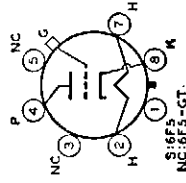

Heater volts (ac/dc), 6.3; amperes, 0.3. Typical operation as class A₁ amplifier: plate volts, 250 (300 maz); grid volts, -2; amplification factor, 100; plate resistance (approx.), 60000 ohms; transconductance, 1500 μ hos; plate ma, 0.9. Peak heater-cathode volts, 90 maz. Type 6F5-GT is a DISCONTINUED type listed for reference only. Type 6F5 is used principally for renewal purposes.

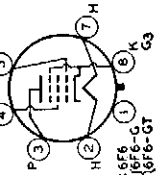

POWER PENTODE

Metal type 6F6 and glass octal types 6F6-G and 6F6-GT used in the audio output stage of ac receivers. Tubes are capable of large power output with relatively small input voltage.

Outlines 5, 26, and 14E, respectively, OUTLINES SECTION. Type 6F6-GT may be supplied with pin No.1 omitted. Tubes require octal socket and may be mounted in any position. It is especially important that these tubes, like other power-handling tubes, be adequately ventilated. Types 6F6-G and 6F6-GT are used principally for renewal purposes. Heater volts (ac/dc), 6.3; amperes, 0.7.

CLASS A₁ AMPLIFIER

Maximum Ratings, (Design-Center Values):

PLATE VOLTAGE.....	375 maz	Triode Connection*	250
GRID-NO.2 (SCREEN-GRID) VOLTAGE.....	285 maz	Pentode Connection	285
PLATE DISSIPATION.....	11 maz		-20
GRID-NO.2 INPUT.....	3.75 maz		20
PEAK HEATER-CATHODE VOLTAGE:			31
Heater negative with respect to cathode.....	90 maz		34
Heater positive with respect to cathode.....	90 maz		—

Typical Operation:

Plate Voltage.....	250	285
Grid-No.2 Voltage.....	250	285
Grid-No.1 (Control-Grid) Voltage.....	-16.5	-20
Peak AF Grid-No.1 Voltage.....	16.5	20
Zero-Signal Plate Current.....	34	38
Maximum-Signal Plate Current.....	36	40
Zero-Signal Grid-No.2 Current.....	6.5	7
Maximum-Signal Grid-No.2 Current.....	10.5	13
Amplification Factor.....	—	80000
Plate Resistance (Approx.).....	2500	2550
Transconductance.....	7000	7000
Load Resistance.....	8	9
Total Harmonic Distortion.....	3.2	4.8
Maximum-Signal Power Output.....	—	—

PUSH-PULL CLASS A₁ AMPLIFIER

Maximum Ratings: (Same as for class A₁ amplifier)

Typical Operation (Values are for two tubes):

Plate Voltage.....	315
Grid-No.2 Voltage.....	285
Grid-No.1 (Control-Grid) Voltage.....	-24
Peak AF Grid-No.1-to-Grid-No.1 Voltage.....	48
Zero-Signal Plate Current.....	80
Maximum-Signal Plate Current.....	80
Zero-Signal Grid-No.2 Current.....	12
Maximum-Signal Grid-No.2 Current.....	19.5
Effective Load Resistance (Plate-to-plate).....	10000
Total Harmonic Distortion.....	4
Maximum-Signal Power Output.....	11

Maximum Circuit Values:

- Grid-No.1 Circuit Resistance: For fixed-bias operation.
- For cathode-bias operation.
- * Grid No.2 connected to plate.

LOW-MU TRIODE—REMOTE-CUTOFF PENTODE

Glass type adaptable to circuit design in several ways. Outline 24B, OUTLINES SECTION. Heater volts (ac/dc), 6.3; amperes, 0.3. Typical operation as class A amplifier: pentode unit -plate volts, 250 maz; grid-No.2 volts, 100; grid-No.1 volts, -3; plate resistance, 0.85 megohms; transconductance, 1100 μ mbos; plate ma., 6.5; grid-No.2 ma., 1.5; triode unit—plate volts, 100 maz; grid volts, -3; amplification factor, 8; plate resistance, 0.016 megohm; transconductance, 500 μ mbos; plate ma., 3.5. This type is used principally for renewal purposes.

6F7

- 0.1 maz megohm
- 0.5 maz megohm

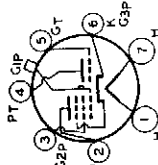

100 maz; grid volts, -3; amplification factor, 8; plate resistance, 0.016 megohm; transconductance, 500 μ mbos; plate ma., 3.5. This type is used principally for renewal purposes.

MEDIUM-MU TWIN TRIODE

Glass octal type used as voltage amplifier or phase inverter in radio equipment. Outline 23, OUTLINES SECTION. Tube requires octal socket. Except for the heater rating of 6.3 volts (ac/dc) and 0.6 ampere and interelectrode capacitances, each triode unit is identical electrically with type 6J5. Type 6F8-G is used principally for renewal purposes.

6F8G

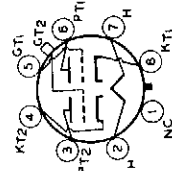

DIODE—SHARP-CUTOFF, TWIN-PLATE TETRODE

Miniature type used in frequency-divider and complex-wave generator circuits of electronic musical instruments. Outline 8D, OUTLINES SECTION. Tube requires miniature nine-contact socket and may be operated in any position.

6FA7

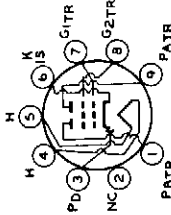

HEATER VOLTAGE (AC/DC)	6.3 volts
HEATER CURRENT	0.3 ampere
DIRECT INTERELECTRODE CAPACITANCES:	
Tetrode Unit:	
Grid No.1 to Plate A	0.040 pf
Grid No.1 to Plate B	0.080 maz
Grid No.1 to Cathode, Heater, Grid No.2, and Internal Shield	5.5 pf
Plate A to Cathode, Heater, Grid No.2	1.8 pf
Plate B to Cathode, Heater, Grid No.2, and Internal Shield	1.8 pf
Tetrode Grid No.1 to Diode Plate	0.022 pf
Tetrode Plate A to Diode Plate	0.020 maz
Tetrode Plate B to Diode Plate	0.055 pf

CLASS A₁ AMPLIFIER

Characteristics, (Tetrode Unit):	
Plate A and Plate B connected together	
Plate Voltage	100 volts
Grid-No.2 Voltage	100 volts
Grid-No.1 Supply Voltage	0
Grid-No.1 Resistor (Bypassed)	2.2 megohms
Plate Resistance (Approx.)	90000 ohms
Transconductance	3200 μ mbos
Plate Current	3.8 ma
Grid-No.2 Current	1.7 ma
Grid-No.1 Voltage (Approx.) for plate current of 20 μ a	-4

Using either Plate A or B, with unused plate grounded

Plate Voltage	100 volts
Grid-No.2 Voltage	100 volts
Grid-No.1 Supply Voltage	0
Grid-No.1 Resistor (Bypassed)	2.2 megohms
Plate Resistance (Approx.)	130000 ohms
Transconductance	1900 μ mbos
Plate Current	2.2 ma
Grid-No.2 Current	3

FREQUENCY DIVIDER & COMPLEX-WAVE GENERATOR

Tetrode Unit

- Maximum Ratings, (Design-Maximum Values):
- PLATE-A VOLTAGE..... volts
- PLATE-B VOLTAGE..... volts
- GRID-No.2 (SCREEN-GRID) SUPPLY VOLTAGE..... volts
- GRID-No.2 VOLTAGE..... volts
- GRID-No.1 (CONTROL-GRID) VOLTAGE:
 - Negative-bias value.....
 - Positive-bias value.....
- PLATE-A DISSIPATION..... watts
- PLATE-B DISSIPATION..... watts
- GRID-No.2 INPUT..... watts
- For grid-No.2 voltages up to 165 volts.....
- For grid-No.2 voltages between 165 and 330 volts.....
- PEAK HEATER-CATHODE VOLTAGE:
 - Heater negative with respect to cathode.....
 - Heater positive with respect to cathode.....

- Maximum Circuit Values:
 - Grid-No.1 Circuit Resistance: For grid-No.1 resistor-bias operation..... 2.2 maz megohms

Diode Unit

- Maximum Ratings, (Design-Maximum Values):
- PLATE CURRENT..... 1 maz ma
- Characteristics, Instantaneous Value:
 - Tube Voltage Drop for plate current of 2 ma..... 10 volts
 - The dc component must not exceed 100 volts.

AVERAGE CHARACTERISTICS

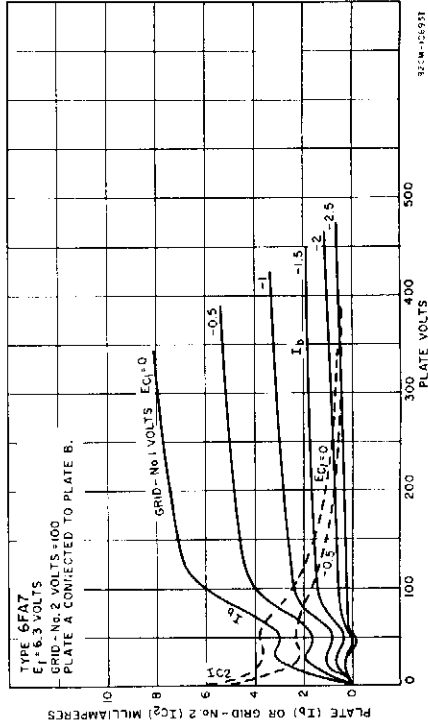

DUAL TRIODE

Glass type containing high-mu and low-mu triode units used as combined vertical-deflection oscillator and vertical-deflection amplifier in television receivers. Maximum dimensions: over-all length, 2.9 inches; seated height, 2.62 inches; diameter, 1.188 inches. Tube requires miniature nine-contact socket and may be mounted in any position. Heater volts (ac/dc), 6.3; amperes, 0.925.



6FD7

Related type: 13FD7

CLASS A₁ AMPLIFIER

Characteristics:		Unit No. 1	Unit No. 2
Plate Voltage	250	60	150
Grid Voltage	-3	0	-17.5
Amplification Factor	64	-	6
Plate Resistance (Approx.)	40000	-	800
Transconductance	1600	-	7500

Plate Current.....	1.4	95 ^c	40	ma
Grid Voltage (Approx.).....	5.5	-	-	volts
For plate current of 10 μ a.....	-	-	40	volts
For plate current of 100 μ a.....	-	-	500	μ mhos
Transconductance, for plate current of 1 ma.....	-	-	6	ma
Plate Current, for grid voltage of -25 volts.....	-	-	-	-

VERTICAL-DEFLECTION OSCILLATOR AND AMPLIFIER

For operation in a 525-line, 30-frame system

Unit No. 1 Oscillator.....	330	max	volts
Unit No. 2 Amplifier.....	1500	max	volts
DC PLATE VOLTAGE.....	330	max	volts
PEAK POSITIVE-PULSE PLATE VOLTAGE*.....	1500	max	volts
PEAK NEGATIVE-PULSE GRID VOLTAGE.....	-250	max	volts
PEAK CATHODE CURRENT.....	70	max	ma
PEAK CATHODE CURRENT.....	20	max	ma
AVERAGE CATHODE CURRENT.....	1.5	max	watts
PLATE DISSIPATION.....	200	max	volts
PEAK HEATER-CATHODE VOLTAGE.....	200*	max	volts
Heater negative with respect to cathode.....	-	-	-
Heater positive with respect to cathode.....	-	-	-

Maximum Circuit Values:
 Grid-Circuit Resistance..... 2.2 *max* megohms
 For grid-resistor-bias or cathode-bias operation..... 2.2 *max* megohms
 This value can be measured by a method involving a recurrent waveform such that the maximum ratings of the tube will not be exceeded.
 The duration of the voltage pulse must not exceed 15 per cent of one vertical scanning cycle. In a 525-line, 30-frame system, 15 per cent of one vertical scanning cycle is 2.5 milliseconds.
 The dc component must not exceed 100 volts.

BEAM POWER TUBE

Glass octal type used in the audio output stages of compact stereophonic phonographs and in radio and television receivers. Tube has high sensitivity at very low plate and screen-grid voltages; it can deliver relatively high power output at low values of plate load resistance. Outline 14F, OUTLINES SECTION. Tube requires octal socket and may be mounted in any position.

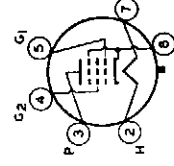

HEATER VOLTAGE (AC/DC).....	6.3	volts
HEATER CURRENT.....	1.2	amperes
DIRECT INTERELECTRODE CAPACITANCES (Approx.):		pf
Grid No.1 to Plate.....	0.44	pf
Grid No.1 to Cathode, Heater, Grid No.2, and Grid No.3.....	15	pf
Plate to Cathode, Heater, Grid No.2, and Grid No.3.....	9	pf

CLASS A₁ AMPLIFIER

Maximum Ratings, (Design-Maximum Values):		
PLATE VOLTAGE.....	175	max
GRID-NO.2 (SCREEN-GRID) VOLTAGE.....	175	max
GRID-NO.2 INPUT.....	2.4	max
PLATE DISSIPATION.....	14.5	max
PEAK HEATER-CATHODE VOLTAGE.....	300	max
Heater negative with respect to cathode.....	-	-
Heater positive with respect to cathode.....	200*	max

Typical Operation:		
Plate Supply Voltage.....	130	145
Grid-No.2 Supply Voltage.....	130	145
Grid-No.1 (Control-Grid) Voltage.....	12.5	-16
Cathode-Bias Resistor.....	12.5	15
Peak AF Grid-No.1 Voltage.....	80	88
Zero-Signal Plate Current.....	94	100
Maximum-Signal Plate Current.....	4	4
Zero-Signal Grid-No.2 Current.....	15	18
Maximum-Signal Grid-No.2 Current.....	-	-
Plate Resistance (Approx.).....	8000	-

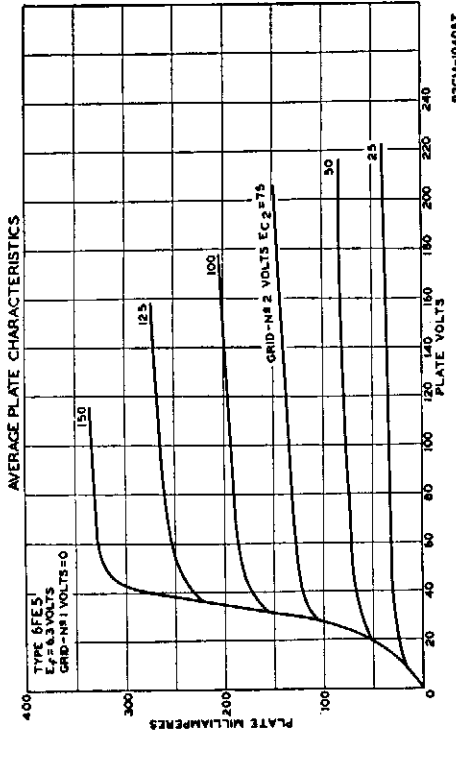

92CM-10403T

Transconductance.....	9500	μ mhos
Load Resistance.....	1000	1000
Total Harmonic Distortion.....	12	15
Maximum-Signal Power Output.....	4.2	5.6
	8.5	4.3

PUSH-PULL CLASS A₁ AMPLIFIER

Maximum Ratings: (Same as for class A₁ amplifier)

Typical Operation (Values are for two tubes):

Plate Supply Voltage.....	130	volts
Grid-No.2 Supply Voltage.....	130	volts
Cathode-Bias Resistor.....	75	ohms
Peak AF Grid-No.1-to-Grid-No.1 Voltage.....	25.8	volts
Zero-Signal Plate Current.....	150	ma
Maximum-Signal Plate Current.....	184	ma
Zero-Signal Grid-No.2 Current.....	7.2	ma
Maximum-Signal Grid-No.2 Current.....	17	ma
Effective Load Resistance (Plate-to-plate).....	1600	ohms
Total Harmonic Distortion.....	6	per cent
Maximum-Signal Power Output.....	7	watts

Maximum Circuit Values:

Grid-No.1-Circuit Resistance.....	0.1	max
For fixed-bias operation.....	0.5	max
For cathode-bias operation.....	-	-

The dc component must not exceed 100 volts.

AVERAGE CHARACTERISTICS

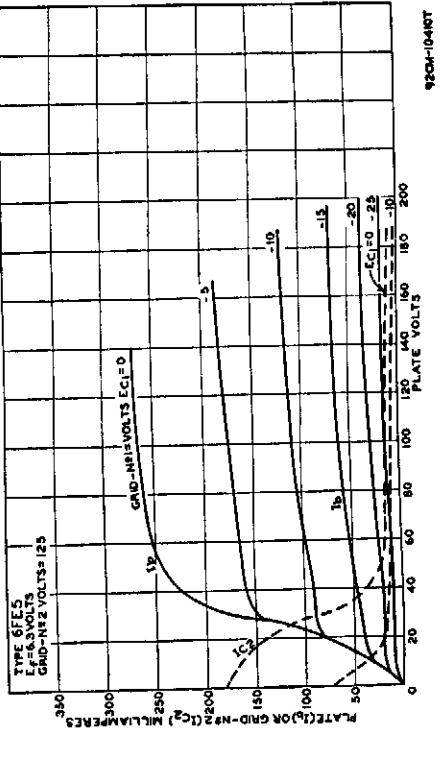

6FG6

Refer to type EM84/6FG5

MEDIUM-MU TRIODE— SHARP-CUTOFF PENTODE

Miniature type used as combined oscillator and mixer tube in vhf television receivers employing series-connected heater strings. Outline 8B, OUTLINE SECTION. Tube requires miniature nine-contact socket and may be mounted in any position. Heater volts (ac/dc), 6.3; amperes, 0.45, warm-up time (average), 11 seconds.

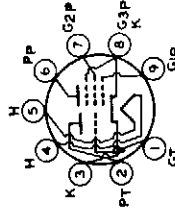

CLASS A₁ AMPLIFIER

Maximum Ratings, (Design-Maximum Values):	
PLATE VOLTAGE.....	Triode Unit 330 max
GRID-NO.2 (SCREEN-GRID) SUPPLY VOLTAGE.....	330 max
GRID-NO.2 VOLTAGE.....	See curve page 70
GRID-NO.1 (CONTROL-GRID) VOLTAGE, Positive-bias value.....	0 max
GRID-NO.2 INPUT:	
For grid-No.2 voltages up to 165 volts.....	0.55 max watt
For grid-No.2 voltages between 165 and 330 volts.....	See curve page 70
PEAK HEATER-CATHODE VOLTAGE:	
Heater negative with respect to cathode.....	3 max watts
Heater positive with respect to cathode.....	200 max volts
	200 max°
Characteristics:	
Plate Voltage.....	125 volts
Grid-No.2 Voltage.....	100 125 volts
Grid-No.1 Voltage.....	0 -1 volts
Amplification Factor.....	43
Transconductance.....	5700 ohms
Plate Resistance (Approx.).....	7500 6000 μmhos
Plate Current.....	13 ma
Grid-No.2 Current.....	4 ma
Grid-No.1 Voltage (Approx.) for plate current of 30 μa.....	-6.5 volts

* The dc component must not exceed 100 volts.

HIGH-MU TRIODE

Miniature type used as an rf amplifier in vhf tuners of television receivers. Outline 7B, OUTLINE SECTION. Tube requires seven-contact socket and may be mounted in any position.

6FH5

Related types
2FH5, 3FH5

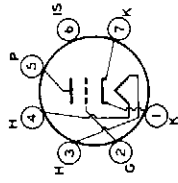

HEATER VOLTAGE (AC/DC).....	6.3 volts
HEATER CURRENT.....	0.2 ampere
DIRECT INTERELECTRODE CAPACITANCES (Approx.):	
Grid to Plate.....	Without External Shield 0.52 pf
Plate to Cathode, Heater, and Internal Shield.....	3.2 pf
Grid to Cathode.....	3.2 pf
Plate to Cathode, Heater, and Internal Shield.....	3.2 pf
• With external shield connected to cathode.	
Maximum Ratings, (Design-Maximum Values):	
PLATE VOLTAGE.....	150 max volts
GRID VOLTAGE, Positive-bias value.....	0 max volts
CATHODE CURRENT.....	22 max ma
PLATE DISSIPATION.....	2.2 max watts
PEAK HEATER-CATHODE VOLTAGE:	
Heater negative with respect to cathode.....	100 max volts
Heater positive with respect to cathode.....	100 max volts

CLASS A₁ AMPLIFIER

Maximum Ratings, (Design-Maximum Values):	
PLATE VOLTAGE.....	100 volts
Grid Voltage.....	1
Amplification Factor.....	40
Plate Resistance (Approx.).....	7400 ohms
Transconductance.....	5400 μmhos
Plate Current.....	7.9 volts
Grid Voltage (Approx.) for plate current of 100 μa.....	-7
Plate-No.2 Voltage.....	250 volts
Grid-No.2 Voltage.....	250 volts

Plate Voltage.....	135 volts
Grid Voltage.....	1 volt
Plate Resistance (Approx.).....	5600 ohms
Transconductance.....	9000 μmhos
Plate Current.....	11 ma
Grid Voltage (Approx.) for plate current of 100 μa.....	-5.5 volts

Maximum Circuit Values:

Grid-Circuit Resistance:	1 megohm
For cathode-bias operation.....	

AVERAGE PLATE CHARACTERISTICS

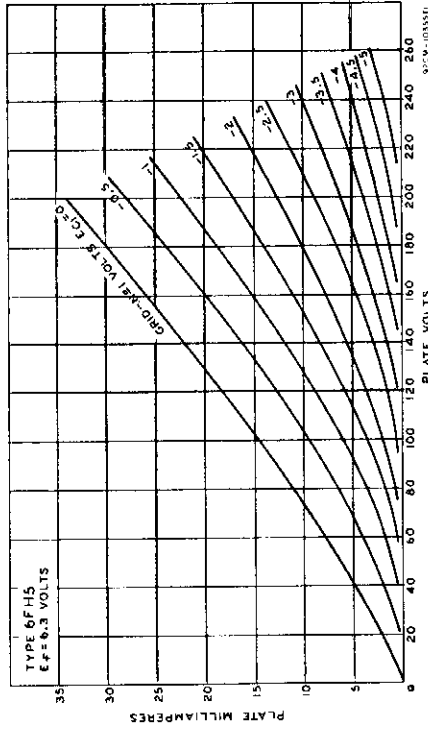

MEDIUM-MU TRIODE— THREE-PLATE TETRODE

Miniature type used in complex-wave generator applications. Sharp-cutoff tetrode unit has pair of additional plates. Outline 8B, OUTLINE SECTION. Tube requires nine-contact socket and may be mounted in any position.

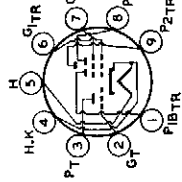

HEATER VOLTAGE (AC/DC).....	6.3 volts
HEATER CURRENT.....	0.45 ampere
DIRECT INTERELECTRODE CAPACITANCES:	
Triode Unit:	
Grid to Plate.....	1.4 pf
Grid to Cathode and Heater.....	2.6 pf
Plate to Cathode and Heater.....	1 pf
Tetrode Unit:	
Grid No.1 to Plate No.2.....	0.06 max pf
Grid No.1 to Cathode, Heater, Grid No.2, Plate No.1A, and Plate No.1B.....	4.5 pf
Plate No.2 to Cathode, Heater, Grid No.2, Plate No.1A, and Plate No.1B.....	1.4 pf
Tetrode Grid No.1 to Triode Plate.....	0.35 max pf
Tetrode Plate No.2 to Triode Plate.....	0.008 max pf

CLASS A₁ AMPLIFIER

Triode Unit

Characteristics:

Plate Voltage.....	100 volts
Grid Voltage.....	1 volt
Amplification Factor.....	40
Plate Resistance (Approx.).....	7400 ohms
Transconductance.....	5400 μmhos
Plate Current.....	7.9 volts
Grid Voltage (Approx.) for plate current of 100 μa.....	-7
Plate-No.2 Voltage.....	250 volts
Grid-No.2 Voltage.....	250 volts

Tetrode Unit with Plates No. 1A and No. 1B Connected to Cathode at Socket

Plate Voltage.....	100 volts
Grid Voltage.....	1 volt
Amplification Factor.....	40
Plate Resistance (Approx.).....	7400 ohms
Transconductance.....	5400 μmhos
Plate Current.....	7.9 volts
Grid Voltage (Approx.) for plate current of 100 μa.....	-7
Plate-No.2 Voltage.....	250 volts
Grid-No.2 Voltage.....	250 volts

Grid-No.1 Voltage.....	0.75	volts
Plate-No.2 Resistance (Approx.).....	4400	megohms
Transconductance, Grid No.1 to Plate No.2.....	7.3	ma
Plate-No.2 Current.....	1.4	ma
Grid-No.2 Current.....	1.4	ma
Grid-No.1 Voltage (Approx.) for plate-No.2 current of 100 μ a.....	1.7	volts

COMPLEX-WAVE GENERATOR

Maximum Ratings, (Design-Maximum Values):		
PLATE VOLTAGE.....	200 mar	volts
PLATE-NO.1A VOLTAGE.....	200 mar	volts
PLATE-NO.1B VOLTAGE.....	275 mar	volts
PLATE-NO.2 VOLTAGE.....	275 mar	volts
GRID-NO.2 (SCREEN-GRID) SUPPLY VOLTAGE.....	See curve page 70	volts
GRID-NO.2 VOLTAGE.....	-40 mar	volts
GRID-NO.1 (CONTROL-GRID) VOLTAGE.....	0 mar	volts
Negative-bias value.....	1.7 mar	volts
PLATE DISSIPATION.....	0.3 mar	watt
PLATE-NO.1A DISSIPATION.....	0.3 mar	watt
PLATE-NO.1B DISSIPATION.....	2.3 mar	watts
PLATE-NO.2 DISSIPATION.....	0.45 mar	watt
GRID-NO.2 INPUT.....	See curve page 70	watt

Typical Operation With Separate Plate Operation (Tetrode Unit):

Plates-No.1A, No.1B, and No.2 Voltage.....	100	volts
Grid-No.2 Voltage.....	50	volt
Grid-No.1 Voltage.....	0.04	ma
Plate-No.1A Current.....	0.04	ma
Plate-No.1B Current.....	1.6	ma
Plate-No.2 Current.....	0.3	ma
Grid-No.2 Current.....	0.3	ma
Transconductance (Approx.):		
Grid No.1 to Plate No.1A.....	70	amhos
Grid No.1 to Plate No.1B.....	70	amhos
Grid No.1 to Plate No.2.....	2500	amhos

Maximum Circuit Values:		
Grid-No.1-Circuit Resistance.....	0.5 mar	Tetrode Unit
For fixed-bias operation.....	0.5 mar	megohm

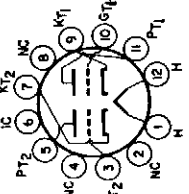

MEDIUM-MU DUAL TRIODE

Duodec type used as combined vertical-deflection-oscillator and vertical-deflection-amplifier tube in television receivers. Outline 12B, OUTLINES SECTION. Tube requires duodec twelve-contact socket and may be mounted in any position. Heater volts (ac/dc), 6.3; amperes, 0.9.

6FJ7

CLASS A₁ AMPLIFIER

Characteristics:		
Plate Voltage.....	250	volts
Grid Voltage.....	150	volts
Amplification Factor.....	8	
Plate Resistance (Approx.).....	22.5	ohms
Transconductance.....	9000	amhos
Plate Current.....	2500	ma
Grid Voltage (Approx.) for plate current of 10 μ a.....	8	volts
Grid Voltage (Approx.) for plate current of 50 μ a.....	-18	volts

VERTICAL-DEFLECTION OSCILLATOR AND AMPLIFIER

<i>For operation in a 525-line, 30-frame system</i>		
Unit No.1	Unit No.2	
Oscillator	Amplifier	
350 mar	350 mar	volts
-400 mar	2500 mar	volts
-	-250 mar	volts
-	150 mar	ma
-	50 mar	ma
1 mar	10 mar	watts
200 mar	200 mar	volts
200 ^{1/2} mar	200 ^{1/2} mar	volts

Maximum Circuit Values:
Grid-Circuit Resistance:
For fixed-bias operation..... 2.2 mar
For cathode-bias operation..... 2.2 mar
This value can be measured by a method involving a recurrent waveform such that the maximum ratings of the tube will not be exceeded.
The duration of the voltage pulse must not exceed 15 per cent of one vertical scanning cycle. In a 525-line, 30-frame system, 15 per cent of one vertical scanning cycle is 2.5 milliseconds.
The dc component must not exceed 100 volts.

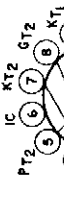

DUAL TRIODE

Duodec type used as combined vertical-deflection oscillator and vertical-deflection amplifier in television receivers. The high-mu triode unit No.1 is used as an oscillator, and the low-mu triode unit No.2 is used as an amplifier. Outline 12B, OUTLINES SECTION. Tube requires duodec twelve-contact socket and may be mounted in any position. Heater volts (ac/dc), 6.3; amperes, 1.05.

6FM7

CLASS A₁ AMPLIFIER

Characteristics:		
Plate Voltage.....	250	volts
Grid Voltage.....	-3	volts
Amplification Factor.....	66	
Plate Resistance (Approx.).....	30000	ohms
Transconductance.....	2200	amhos
Grid Voltage (Approx.) for plate current of 20 μ a.....	-5.3	volts
Grid Voltage (Approx.) for plate current of 200 μ a.....	-	volts
Plate Current.....	2	ma

VERTICAL-DEFLECTION OSCILLATOR AND AMPLIFIER

<i>For operation in a 525-line, 30-frame system</i>		
Unit No.1	Unit No.2	
Oscillator	Amplifier	
350 mar	1500 mar	volts
-400 mar	-250 mar	volts
-	175 mar	ma
-	50 mar	ma
1 mar	10 mar	watts
200 mar	200 mar	volts
200 ^{1/2} mar	200 ^{1/2} mar	volts

Maximum Ratings, (Design-Maximum Values):
DC PLATE VOLTAGE..... 350 mar
PEAK POSITIVE-PULSE PLATE VOLTAGE#..... -
PEAK NEGATIVE-PULSE PLATE VOLTAGE..... -400 mar
PEAK CATHODE CURRENT..... -
AVERAGE CATHODE CURRENT..... 1 mar
PLATE DISSIPATION..... 1 mar
PEAK HEATER-CATHODE VOLTAGE..... 200 mar
Heater negative with respect to cathode..... 200^{1/2} mar
Heater positive with respect to cathode..... 200^{1/2} mar

Maximum Circuit Values:

Grid-Circuit Resistance:		
For fixed-bias operation.....	1 mar	1 mar
For cathode-bias operation.....	2.2 mar	2.2 mar

TWIN DIODE—HIGH-MU TRIODE

Miniature type used as combined FM detector and af voltage amplifier in FM receivers. Outline 8B, OUTLINES SECTION. Tube requires miniature nine-contact socket and may be operated in any position. Heater volts (ac/dc), 6.3; amperes, 0.45.

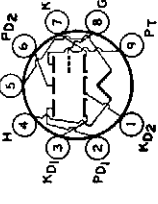

TRIODE UNIT AS CLASS A₁ AMPLIFIER

Maximum Ratings, (Design-Maximum Values):		
PLATE VOLTAGE.....	330 mar	volts
Grid Voltage, Positive-bias value.....	0 mar	volts

6FM8

PLATE DISSIPATION..... watts
 PEAK HEATER-CATHODE VOLTAGE..... volts
 Heater negative with respect to cathode.
 Heater positive with respect to cathode.

Characteristics:

Grid Voltage..... volts
 Plate Voltage..... volts
 Amplification Factor..... ohms
 Plate Resistance (Approx.)..... μ mhos
 Transconductance..... ma

DIODE UNITS (Each Unit)

Maximum Ratings, (Design-Maximum Values):
 PLATE CURRENT..... ma
 PEAK HEATER-CATHODE VOLTAGE..... volts
 Heater negative with respect to cathode.
 Heater positive with respect to cathode.

Characteristics, Instantaneous Value:

Tube Voltage Drop for plate current of 20 ma..... volts
 ° The dc component must not exceed 100 volts.

HIGH-MU TRIODE

Miniature type with frame grid used as rf-amplifier tube in vhf tuners of television receivers. Outline 7B, OUTLINES SECTION. Tube requires miniature seven-contact socket

6FQ5A

and may be mounted in any position. Heater volts (ac/dc), 6.3; amperes, 0.18.

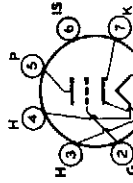

CLASS A₁ AMPLIFIER

Maximum Ratings, (Design-Maximum Values):

PLATE VOLTAGE..... volts
 GRID VOLTAGE, Negative-bias value..... volts
 AVERAGE CATHODE CURRENT..... ma
 PLATE DISSIPATION..... watts
 PEAK HEATER-CATHODE VOLTAGE..... volts
 Heater negative with respect to cathode.
 Heater positive with respect to cathode.

Characteristics:

Plate Voltage..... volts
 Grid Voltage..... volts
 Amplification Factor..... ohms
 Plate Resistance (Approx.)..... μ mhos
 Transconductance..... ma
 Grid Voltage (Approx.) for plate current of 100 μ a..... volts

Maximum Circuit Values:

Grid-Circuit Resistance:
 For cathode-bias operation..... 1 ma μ megohm

MEDIUM-MU TWIN TRIODE

Miniature type used as combined vertical- and horizontal-deflection oscillator in television receivers. Outline 8D, OUTLINES SECTION. Tube requires miniature nine-contact socket

6FQ7

Related type: 8FQ7

and may be operated in any position. Except for direct interelectrode capacitances, this type is identical with miniature type 6CG7. For typical operation as a resistance-coupled amplifier, refer to RESISTANCE-COUPLED AMPLIFIER SECTION.

HEATER VOLTAGE (AC/DC)..... volts
 HEATER CURRENT..... ampere
 HEATER WARM-UP TIME (AVERAGE)..... seconds

DIRECT INTERELECTRODE CAPACITANCES (Approx.):

Grid to Plate.....	Unit No. 1	Unit No. 2
Grid to Cathode and Heater.....	3.6	3.8
Plate to Cathode.....	2.4	2.4
Plate to Unit No.1 to Plate of Unit No.2.....	0.34	0.26
	1	

BEAM HEXODE

Miniature type used as rf-amplifier tube in vhf television receivers. In this tube, grid No.1 is the control grid, grid No.2 is a focusing grid, grid No.3 is the screen grid, and grid No.4 is the suppressor grid. Grid No.2 is internally connected to the cathode and grid No.4, and aligned with grid No.3. Outline 7B, OUTLINES SECTION. Tube requires miniature seven-contact socket and may be mounted in any position. Heater volts (ac/dc), 6.3; amperes, 0.2.

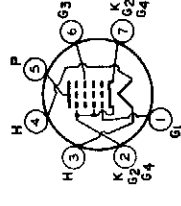

6F55

Related type: 2F55

CLASS A₁ AMPLIFIER

Maximum Ratings, (Design-Maximum Values):

PLATE VOLTAGE..... volts
 GRID-No.3 (SCREEN-GRID) VOLTAGE..... volts
 GRID-No.1 (CONTROL-GRID) VOLTAGE..... volts
 Negative-bias value..... volts
 Positive-bias value..... ma
 CATHODE CURRENT..... ma
 GRID-No.3 INPUT..... watt
 PLATE DISSIPATION..... watts
 PEAK HEATER-CATHODE VOLTAGE..... volts
 Heater negative with respect to cathode.
 Heater positive with respect to cathode.

Characteristics:

Plate Voltage..... volts
 Grid-No.3 Voltage..... volts
 Grid-No.1 Voltage..... volt
 Plate Resistance (Approx.)..... megohm
 Transconductance..... μ mhos
 Plate Current..... ma
 Grid-No.3 Current..... ma
 Grid-No.1 Voltage (Approx.) for transconductance of 100 μ mhos..... volts

Maximum Circuit Values:

Grid-No.1-Circuit Resistance, for fixed-bias operation..... 0.5 ma μ megohm
 ° The dc component must not exceed 100 volts.

SHARP-CUTOFF TETRODE

Miniature type used as rf amplifier in vhf tuners of television receivers. Outline 7B, OUTLINES SECTION. Tube requires seven-contact socket and may be mounted in any position.

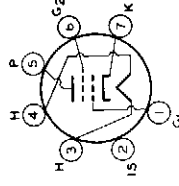

6FV6

HEATER VOLTAGE (AC/DC)..... volts
 HEATER CURRENT..... ampere
 DIRECT INTERELECTRODE CAPACITANCES:
 Grid No.1 to Plate..... 0.03 ma μ z
 Grid No.1 to Cathode, Heater, Grid No.2, and Internal Shield..... 4.5
 Plate to Cathode, Heater, Grid No.2, and Internal Shield..... 9
 Cathode to Heater..... 2.7

CLASS A₁ AMPLIFIER

Maximum Ratings, (Design-Maximum Values):

PLATE VOLTAGE..... volts
 GRID-No.2 (SCREEN-GRID) SUPPLY VOLTAGE..... volts
 GRID-No.2 VOLTAGE..... volts
 GRID-No.1 (CONTROL-GRID) VOLTAGE, Positive-bias value..... volts

2 *max* watts
 200 *max* volts
 200⁰ *max* volts
 3 *max* megohms

PEAK HEATER-CATHODE VOLTAGE:
 Heater negative with respect to cathode.
 Heater positive with respect to cathode.

Maximum Circuit Values:

Grid-Circuit Resistance:
 For cathode-bias operation.
 • The dc component must not exceed 100 volts.

BEAM POWER TUBE

Glass octal type used as horizontal-deflection amplifier in television receivers. Outline 19A, OUTLINES SECTION. Tube requires octal socket and may be mounted in any position. Heater volts (ac/dc), 6.3; amperes, 1.2.

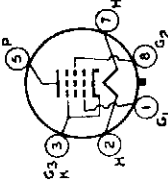

6FW5

HORIZONTAL-DEFLECTION AMPLIFIER

For operation in a 525-line, 30-frame system

Maximum Ratings, (Design-Maximum Values):
 DC PLATE VOLTAGE..... 770 *max* volts
 PEAK POSITIVE-PULSE PLATE VOLTAGE..... 6500 *max* volts
 DC GRID-NO.2 (SCREEN-GRID) VOLTAGE..... 220 *max* volts
 PEAK NEGATIVE-PULSE GRID-NO.1 VOLTAGE..... -330 *max* volts
 DC GRID-NO.1 (CONTROL-GRID) VOLTAGE..... -55 *max* volts
 PEAK CATHODE CURRENT..... 610 *max* ma
 AVERAGE CATHODE CURRENT..... 175 *max* ma
 PLATE DISSIPATION*..... 3.6 *max* watts
 GRID-NO.2 INPUT..... 18 *max* watts
 PEAK HEATER-CATHODE VOLTAGE:
 Heater negative with respect to cathode.
 Heater positive with respect to cathode.
 BULB TEMPERATURE (At hottest point)..... 200⁰ *max* volts
 220 *max* °C

1 *max* megohm

6FW8

MEDIUM-MU TWIN TRIODE

Miniature type used in direct-coupled cathode-drive rt-amplifier circuits of vhf television tuners. In such circuits, one triode unit is used as the direct-coupled grounded-cathode driver for the other unit. Outline 8B, OUTLINES SECTION. Tube requires nine-contact socket. Heater volts (ac/dc), 6.3; amperes, 0.4. Characteristics as class A₁ amplifier (each unit): plate volts, 100 (250 *max*); grid volts, -1.2; amplification factor, 33; plate resistance (approx.), 2500 ohms; transconductance, 13000 μ mbos; plate ma., 15; cathode ma., 22 *max*; plate dissipation, 2.2 *max* watts; peak heater-cathode volts, 200 *max* (the dc component must not exceed 100 volts). This type is used principally for renewal purposes.

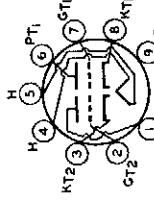

DUAL TRIODE

Duodec type used as combined vertical-deflection oscillator and vertical-deflection amplifier in television receivers. The high-mu triode unit No.1 is used as an oscillator, and the low-mu triode unit No.2 is used as an amplifier. Outline 12D, OUTLINES SECTION.

6FY7

Related type: 15F7

CATHODE CURRENT..... 20 *max* ma
 GRID-NO.2 INPUT:
 For grid-No.2 voltages up to 90 volts..... 0.5 *max* watt
 For grid-No.2 voltages between 90 and 180 volts..... See curve page 70
 PEAK HEATER-CATHODE VOLTAGE:
 Heater negative with respect to cathode.
 Heater positive with respect to cathode.
 Maximum Circuit Values:
 Plate Voltage..... 125 volts
 Grid-No.2 Voltage..... 80 volts
 Grid-No.1 Voltage..... -1 volt
 Plate Resistance (Approx.)..... 8000 megohm
 Transconductance..... 10 μ mbos
 Plate Current..... 1.5 ma
 Grid-No.2 Current..... -6 volts
 Grid-No.1 Voltage (Approx.) for plate current of 20 μ a..... 0.5 *max* megohm

Maximum Circuit Value:
 Grid-No.1-Circuit Resistance.
 • The dc component must not exceed 100 volts.

MEDIUM-MU TRIODE—SHARP-CUTOFF PENTODE

Miniature type used in television receivers as combined oscillator and amplifier. Triode is used as vertical deflection oscillator; pentode is used as if or general-purpose amplifier. Outline 8B, OUTLINES SECTION. Tube requires nine-contact socket and may be operated in any position. Heater volts (ac/dc), 6.3; amperes, 0.45; heater warm-up time (average), 11 seconds.

6FV8
6FV8A
 Related type: 5FV8

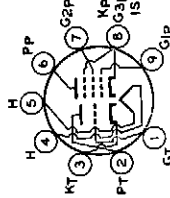

CLASS A₁ AMPIFIER

Pentode Unit

Maximum Ratings, (Design-Maximum Values):
 PLATE VOLTAGE..... 330 *max* volts
 GRID-NO.2 (SCREEN-GRID) SUPPLY VOLTAGE..... 330 *max* volts
 GRID-NO.2 VOLTAGE..... See curve page 70
 GRID-NO.1 (CONTROL-GRID) VOLTAGE, Positive-bias value..... 0 *max* volts
 PLATE DISSIPATION..... 2.3 *max* watts
 GRID-NO.2 INPUT:
 For grid-No.2 voltages up to 165 volts..... 0.55 *max* watt
 For grid-No.2 voltages between 165 and 330 volts..... See curve page 70
 PEAK HEATER-CATHODE VOLTAGE:
 Heater negative with respect to cathode.
 Heater positive with respect to cathode.

Maximum Circuit Values:

Grid-No.1-Circuit Resistance:
 For fixed-bias operation.
 For cathode-bias operation.

Characteristics:	Triode Unit 6FV8	Pentode Unit 6FV8A
Plate Voltage.....	125	125
Grid-No.2 Voltage.....	-1	-1
Grid-No.1 Voltage.....	40	45
Amplification Factor.....	5600	8000
Plate Resistance (Approx.).....	8000	8000
Transconductance.....	-9	-7.5
Grid-No.1 Voltage (Approx.) for plate current of 20 μ a.....	14	12
Plate Current.....	12	12
Grid-No.2 Current.....	4	4

VERTICAL-DEFLECTION OSCILLATOR—TRIODE UNIT

For operation in a 525-line, 30-frame system

Maximum Ratings, (Design-Maximum Values):
 DC PLATE VOLTAGE..... 330 *max* volts
 PEAK NEGATIVE-PULSE GRID VOLTAGE..... -250 *max* volts
 PEAK CATHODE CURRENT..... 10 *max* ma
 AVERAGE CATHODE CURRENT..... 20 *max* ma

Tube requires duodecarr twelve-contact socket and may be mounted in any position. Heater volts (ac/dc), 6.3; amperes, 1.05.

CLASS A₁ AMPLIFIER

	Unit No. 1	Unit No. 2
Characteristics:		
Plate Voltage.....	250	150
Grid Voltage.....	-3	17.5
Amplification Factor.....	65	6
Plate Resistance (Approx.).....	40500	800
Transconductance.....	1600	7500
Grid Voltage (Approx.) for plate current of 30 μ a.....	-5.5	-
Grid Voltage (Approx.) for plate current of 50 μ a.....	1.4	45
Plate Current.....	-	10
Plate Current (Approx.) for grid voltage of -25 volts.....	-	-

VERTICAL-DEFLECTION OSCILLATOR AND AMPLIFIER

For operation in a 525-line, 30-frame system

	Unit No. 1 Oscillator	Unit No. 2 Amplifier
Maximum Ratings, (Design-Maximum Values):		
DC PLATE VOLTAGE.....	330 <i>max</i>	275 <i>max</i>
PEAK POSITIVE-PULSE PLATE VOLTAGE#.....	-400 <i>max</i>	2000 <i>max</i>
PEAK NEGATIVE-PULSE PLATE VOLTAGE.....	70 <i>max</i>	-250 <i>max</i>
PEAK CATHODE CURRENT.....	20 <i>max</i>	175 <i>max</i>
AVERAGE CATHODE CURRENT.....	1 <i>max</i>	7 <i>max</i>
PLATE DISSIPATION.....	200 <i>max</i>	200 <i>max</i>
PEAK HEATER-CATHODE VOLTAGE.....	200 <i>max</i>	200 <i>max</i>
Heater negative with respect to cathode.....	-	-
Heater positive with respect to cathode.....	-	-

Maximum Circuit Values:

Grid-Circuit Resistance.....	2.2 <i>max</i>
Grid-Circuit Reactance.....	2.2 <i>max</i> megohms
# The duration of the voltage pulse must not exceed 15 per cent of one vertical scanning cycle. In a 525-line, 30-frame system, 15 per cent of one vertical scanning cycle is 2.5 milliseconds.	
† An adequate bias resistor or other means is required to protect the tube in the absence of excitation.	
‡ The dc component must not exceed 100 volts.	

POWER PENTODE

Glass octal type used in output stage of radio receivers where moderate power output is required. Outline 22, OUTLINES SECTION. Tube requires octal socket. Except for inter-electrode capacitances and a plate resistance of 175000 ohms, this type is electrically identical with type 6AK6. Heater volts (ac/dc), 6.3; amperes, 0.15. Type 6G6-G is used principally for renewal purposes.

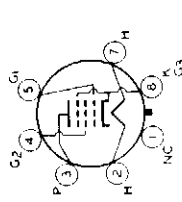

BEAM POWER TUBE—SHARP-CUTOFF PENTODE

Duodecarr type used as FM detector and audio-frequency output amplifier in television receivers. Outline 12B, OUTLINES SECTION. Tube requires duodecarr twelve-contact socket and may be mounted in any position. Heater volts (ac/dc), 6.3; amperes, 1.2.

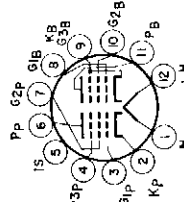

6G11

BEAM POWER TUBE UNIT AS CLASS A₁ AMPLIFIER

	Maximum Ratings, (Design-Maximum Values):
PLATE VOLTAGE.....	150 <i>max</i> volts
GRID-NO.2 (SCREEN-GRID) VOLTAGE.....	185 <i>max</i> volts
AVERAGE CATHODE CURRENT.....	65 <i>max</i> ma
PLATE DISSIPATION.....	6.5 <i>max</i> watts
GRID-NO.2 INPUT.....	1.8 <i>max</i> watts
PEAK HEATER-CATHODE VOLTAGE.....	200 <i>max</i> volts
Heater negative with respect to cathode.....	-
Heater positive with respect to cathode.....	200 <i>max</i> volts

Typical Operation:

Plate Voltage.....	120
Grid-No.2 Voltage.....	110
Grid-No.1 (Control-Grid) Voltage.....	-8
Peak AF Grid-No.1 Voltage.....	8
Zero-Signal Plate Current.....	49
Maximum-Signal Plate Current.....	50
Zero-Signal Grid-No.2 Current.....	4
Maximum-Signal Grid-No.2 Current.....	8.5
Plate Resistance (Approx.).....	10000
Transconductance.....	7500
Load Resistance.....	2500
Total Harmonic Distortion.....	10
Maximum-Signal Power Output.....	2.3

PENTODE UNIT AS CLASS A₁ AMPLIFIER

Characteristics:	
Plate Supply Voltage.....	150
Grid-No.3 (Suppressor-Grid) Voltage.....	0
Grid-No.2 (Screen-Grid) Supply Voltage.....	100
Cathode-Bias Resistor.....	560
Plate Resistance (Approx.).....	0.15
Transconductance, Grid No.1 to Plate.....	1000
Transconductance, Grid No.3 to Plate.....	400
Plate Current.....	1.3
Grid-No.2 Current.....	2
Grid-No.1 Voltage (Approx.) for plate current of 10 μ a.....	-4.5
Grid-No.3 Voltage (Approx.) for plate current of 10 μ a.....	-4.5

PENTODE UNIT AS FM DETECTOR

Maximum Ratings, (Design-Maximum Values):

PLATE VOLTAGE.....	330 <i>max</i> volts
GRID-NO.3 VOLTAGE.....	28 <i>max</i> volts
GRID-NO.2 SUPPLY VOLTAGE.....	330 <i>max</i> volts
GRID-NO.2 VOLTAGE.....	See curve page 70
GRID-NO.1 (CONTROL-GRID) VOLTAGE, Positive-bias value.....	0 <i>max</i> volts
PLATE DISSIPATION.....	1.7 <i>max</i> watts
GRID-NO.2 INPUT.....	1.1 <i>max</i> watts
For grid-No.2 voltages up to 165 volts.....	See curve page 70
For grid-No.2 voltages between 165 and 330 volts.....	See curve page 70
PEAK HEATER-CATHODE VOLTAGE.....	200 <i>max</i> volts
Heater negative with respect to cathode.....	-
Heater positive with respect to cathode.....	200 <i>max</i> volts
‡ The dc component must not exceed 100 volts.	

BEAM POWER TUBE

Neonovall type used as output tube in audio-amplifier applications. Outline 11C, OUTLINES SECTION. Tube requires neonovall nine-contact socket and may be mounted in any position.

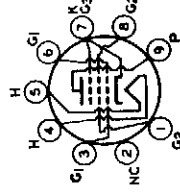

HEATER VOLTAGE (AC/DC).....	6.3
HEATER CURRENT.....	1.2
DIRECT INTERELECTRODE CAPACITANCES (Approx.):	
Grid No.1 to Plate.....	0.9
Grid No.1 to Cathode, Heater, Grid No.2, and Grid No.3.....	18
Plate to Cathode, Heater, Grid No.2, and Grid No.3.....	7

CLASS A₁ AMPLIFIER

Maximum Ratings, (Design-Maximum Values):

PLATE VOLTAGE.....	220 <i>max</i> volts
GRID-NO.2 (SCREEN-GRID) VOLTAGE.....	140 <i>max</i> volts
GRID-NO.2 INPUT.....	1.4 <i>max</i> watts
PLATE DISSIPATION.....	12 <i>max</i> watts
PEAK HEATER-CATHODE VOLTAGE.....	200 <i>max</i> volts
Heater negative with respect to cathode.....	-
Heater positive with respect to cathode.....	200 <i>max</i> volts

6G65

6G6G

AVERAGE PLATE CHARACTERISTICS

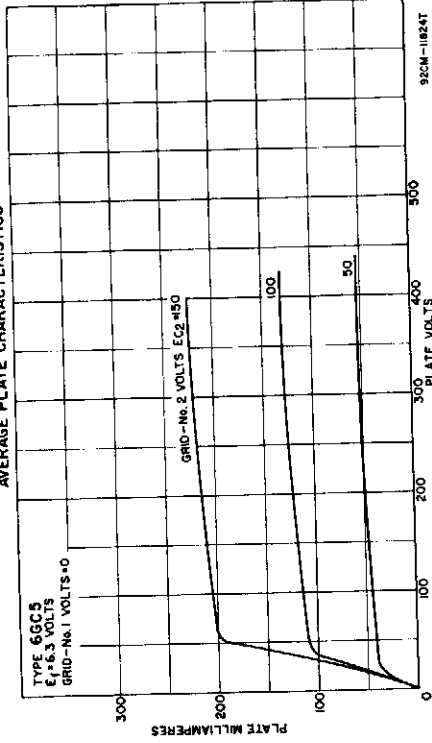

Typical Operation and Characteristics:

Plate Voltage.....	110	volts
Grid-No.2 Voltage.....	110	volts
Grid-No.1 Voltage.....	-7.5	volts
Cathode-Bias Resistor.....	180	ohms
Peak AF Grid-No.1 Voltage.....	7.5	volts
Zero-Signal Plate Current.....	49	ma
Maximum-Signal Plate Current.....	50	ma
Zero-Signal Grid-No.2 Current.....	4	ma
Maximum-Signal Grid-No.2 Current.....	10	ma
Plate Resistance (Approx.).....	13000	ohms
Transconductance.....	8000	μmhos
Load Resistance.....	2000	ohms
Total Harmonic Distortion.....	10	per cent
Maximum-Signal Power Output.....	2.1	watts

Maximum Circuit Values:

Grid-No.1-Circuit Resistance.....	0.1	megohm
For fixed-bias operation.....	0.5	megohm
For cathode-bias operation.....	0.5	megohm

■ The dc component must not exceed 100 volts.

AVERAGE CHARACTERISTICS

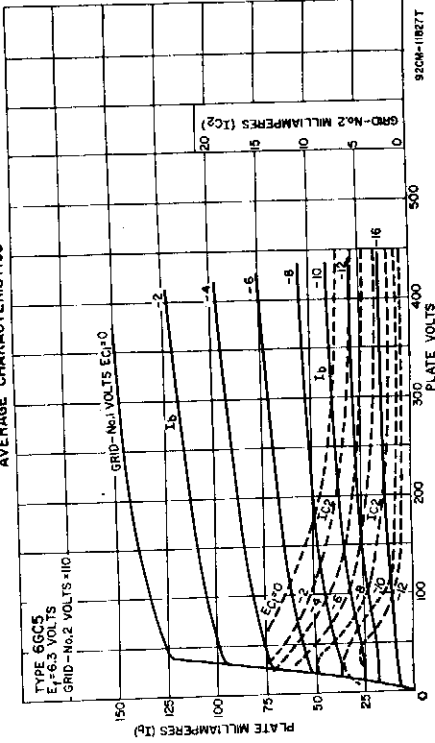

BEAM POWER TUBE

Duodecar type used as horizontal-deflection-amplifier tube in television receivers. Outline 20, OUTLINES SECTION. Tube requires duodecar twelve-contact socket and may be mounted in any position. Heater volts (ac/dc), 6.3; amperes, 1.2.

6GE5

Related types:
12GE5, 17GE5

CLASS A₁ AMPLIFIER

Characteristics:	
Plate Voltage.....	250
Grid-No.2 (Screen-Grid) Voltage.....	150
Grid-No.1 (Control-Grid) Voltage.....	0
Triode Amplification Factor*.....	4.4
Plate Resistance (Approx.).....	18000
Transconductance.....	7300
Plate Current.....	345*
Grid-No.2 Current.....	27*
Grid-No.1 Voltage (Approx.) for plate current of 1 ma.....	-

* Triode connection (grid No.2 tied to plate); plate and grid-No.2 volts = 150.
† This value can be measured by a method involving a recurrent waveform such that the maximum ratings of the tube will not be exceeded.

HORIZONTAL-DEFLECTION AMPLIFIER

For operation in a 525-line, 80-frame system

Maximum Ratings, (Design-Maximum Values):

DC PLATE SUPPLY VOLTAGE.....	770	vac
PEAK POSITIVE-PULSE PLATE VOLTAGE#.....	6500	vac
PEAK NEGATIVE-PULSE PLATE VOLTAGE#.....	-1500	vac
DC GRID-No.2 VOLTAGE.....	220	vac
PEAK NEGATIVE-PULSE GRID-No.1 VOLTAGE.....	-330	vac
DC GRID-No.1 VOLTAGE.....	-65	vac
PEAK CATHODE CURRENT.....	550	ma
AVERAGE CATHODE CURRENT.....	175	ma
PLATE DISSIPATION†.....	17.5	vac
GRID-No.2 INPUT.....	3.5	vac
PEAK HEATER-CATHODE VOLTAGE.....	200	vac
Heater negative with respect to cathode.....	200	vac
Heater positive with respect to cathode.....	200	vac
BULB TEMPERATURE (At hottest point).....	200	°C

Maximum Circuit Values:

Grid-No.1-Circuit Resistance.....	1	megohm
# The duration of the voltage pulse must not exceed 15 per cent of one horizontal scanning cycle. In a 525-line, 80-frame system, 15 per cent of one horizontal scanning cycle is 10 microseconds.		
† An adequate bias resistor or other means is required to protect the tube in the absence of excitation.		
‡ The dc component must not exceed 100 volts.		

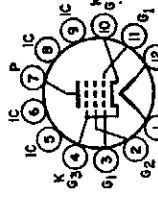

BEAM POWER TUBE

Duodecar type used as horizontal-deflection amplifier in television receivers. Outline 12D, OUTLINES SECTION. Tube requires duodecar twelve-contact socket and may be mounted in any position. Heater volts (ac/dc), 6.3; amperes, 1.2.

6GF5

CLASS A₁ AMPLIFIER

Characteristics:	
Plate Voltage.....	250
Grid-No.2 (Screen-Grid) Voltage.....	150
Grid-No.1 (Control-Grid) Voltage.....	0
Triode Amplification Factor*.....	-26.5
Plate Resistance (Approx.).....	4.2
Transconductance.....	0.26
Plate Current.....	4700
Grid-No.2 Current.....	34
Grid-No.1 Voltage (Approx.) for plate current of 1 ma.....	345*
	33*
	1.6
	-46

HORIZONTAL-DEFLECTION AMPLIFIER

For operation in a 525-line, 30-frame system

Maximum Ratings, (Design-Maximum Values):	
DC PLATE SUPPLY VOLTAGE.....	770 max volts
PEAK POSITIVE-PULSE PLATE VOLTAGE.....	5000 max volts
PEAK NEGATIVE-PULSE PLATE VOLTAGE.....	-1500 max volts
DC GRID-NO.2 VOLTAGE.....	220 max volts
PEAK NEGATIVE-PULSE GRID-NO.1 VOLTAGE.....	-330 max volts
NEGATIVE DC GRID-NO.1 VOLTAGE.....	-55 max volts
PEAK CATHODE CURRENT.....	500 max ma
AVERAGE CATHODE CURRENT.....	160 max ma
PLATE DISSIPATION†.....	9 max watts
GRID-NO.2 INPUT.....	2.5 max watts
PEAK HEATER-CATHODE VOLTAGE:	
Heater negative with respect to cathode.....	200 max volts
Heater positive with respect to cathode.....	200 max volts
BULB TEMPERATURE (At hottest point).....	200 max °C

Maximum Circuit Values:

- Grid-No.1-Circuit Resistance..... 1 maz megohm
- * Triode connection (grid No.2 connected to plate); plate and grid-No.2 volts =150.
- † These values can be measured by a method involving a recurrent waveform such that the maximum ratings of the tube will not be exceeded.
- ‡ The duration of the voltage pulse must not exceed 15 per cent of one horizontal scanning cycle. In a 525-line, 30-frame system, 15 per cent of one horizontal scanning cycle is 10 microseconds.
- § An adequate bias resistor or other means is required to protect the tube in the absence of excitation.
- ¶ The dc component must not exceed 100 volts.

DUAL TRIODE

Novar type containing high-mu and high-perveance, low-mu triode units used as combined vertical-deflection oscillator and vertical-deflection amplifier in television receivers. Out-

line 10A, OUTLINES SECTION. Tube requires novar nine-contact socket and may be mounted in any position. For curves of average plate characteristics for Unit No.1 and Unit No.2, refer to types 6DR7 (Unit No.1) and 6EM7, respectively.

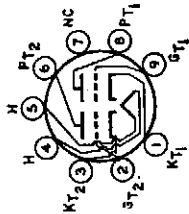

HEATER VOLTAGE (AC/DC).....	6.3 volts
HEATER CURRENT.....	0.985 ampere
DIRECT INTERELECTRODE CAPACITANCES (Approx.)	
Grid to Plate.....	4.6 pf
Grid to Cathode and Heater.....	2.4 pf
Plate to Cathode and Heater.....	0.26 pf

CLASS A₁ AMPLIFIER

Characteristics:	
Plate Voltage.....	Unit No.1 250 volts
Grid Voltage.....	Unit No.2 160 volts
Amplification Factor.....	-3
Plate Resistance (Approx.).....	64 ohms
Transconductance.....	40000 μmhos
Grid Voltage (Approx.):	
For plate current of 1.0 μa.....	-5.5 volts
For plate current of 100 μa.....	-45 volts
Plate Current.....	1.4 ma
For plate voltage of 60 volts and zero grid voltage.....	95 ma
For grid voltage of -28 volts.....	10 ma

VERTICAL-DEFLECTION OSCILLATOR AND AMPLIFIER

For operation in a 525-line, 30-frame system

Maximum Ratings, (Design-Maximum Values):	
DC PLATE VOLTAGE.....	Unit No.1 380 max volts
PEAK POSITIVE-PULSE PLATE VOLTAGE (Absolute Maximum)†.....	Unit No.2 380 max volts
PEAK NEGATIVE-PULSE GRID VOLTAGE.....	1500 max volts
PEAK CATHODE CURRENT.....	-250 max volts
AVERAGE CATHODE CURRENT.....	77 max ma
	22 max ma

PLATE DISSIPATION.....	1.5 max	11 maz	watts
PEAK HEATER-CATHODE VOLTAGE:			
Heater negative with respect to cathode.....	200 max	200 max	volts
Heater positive with respect to cathode.....	200 max	200 max	volts

Maximum Circuit Values:

- Grid-Circuit Resistance..... 2.2 maz
- For grid-resistor-bias or cathode-bias operation..... 2.2 maz megohms
- # Under no circumstances should this absolute value be exceeded.
- The duration of the voltage pulse must not exceed 15 per cent of one vertical scanning cycle. In a 525-line, 30-frame system, 15 per cent of one vertical scanning cycle is 2.5 milliseconds.
- ¶ The dc component must not exceed 100 volts.

**MEDIUM-MU TRIODE—
SHARP-CUTOFF PENTODE**

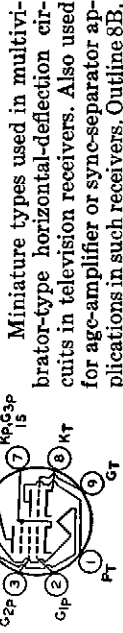

**6GH8
6GH8A**

Related type:
5GH6

Miniature types used in multi-brator-type horizontal-deflection circuits in television receivers. Also used for age-amplifier or sync-separator applications in such receivers. Outline 8B,

OUTLINES SECTION. Tubes require miniature nine-contact socket and may be mounted in any position. Type 6GH8-A is specially controlled to assure low inter-electrode leakage.

HEATER VOLTAGE (AC/DC).....	6.3 volts
HEATER CURRENT.....	0.45 ampere
HEATER WARM-UP TIME (Average).....	11 seconds
DIRECT INTERELECTRODE CAPACITANCES:	
Triode Unit:	
Grid to Plate.....	6GH8 1.5 pf
Grid to Cathode, Heater, Pentode Grid No.3, Pentode Cathode, and Internal Shield.....	3.4 pf
Plate to Cathode, Heater, Pentode Grid No.3, Pentode Cathode, and Internal Shield.....	1.7 pf
Heater to Cathode.....	3 pf
Pentode Unit:	
Grid No.1 to Plate.....	0.02 max
Grid No.1 to Cathode, Heater, Grid No.2, Grid No.3, and Internal Shield.....	5.5 pf
Plate to Cathode, Heater, Grid No.2, Grid No.3, and Internal Shield.....	2.6 pf
Heater to Cathode, Grid No.3, and Internal Shield.....	3 pf

**AVERAGE PLATE CHARACTERISTICS
TRIODE UNIT**

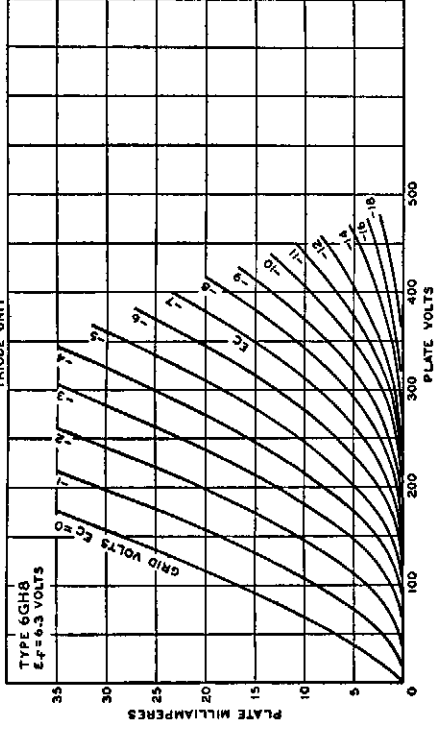

CLASS A₁ AMPLIFIER

	Triode Unit	Pentode Unit
Plate Voltage.....	125	125
Grid-No.2 Voltage.....	125	125
Grid-No.1 Voltage.....	-1	-1
Amplification Factor.....	46	200000
Plate Resistance (Approx.).....	5400	7500
Transconductance.....	18.5	12
Plate Current.....	4	4
Grid-No.2 Current.....	-8	-8
Grid-No.1 Voltage (Approx.) for plate current of 10 μ a.....		

HORIZONTAL-DEFLECTION OSCILLATOR

For operation in a 525-line, 30-frame system

	Triode Unit	Pentode Unit
Maximum Ratings, (Design-Maximum Values):		
Plate Voltage.....	330 maz	330 maz
Grid-No.2 (SCREEN-GRID) VOLTAGE.....	330 maz	330 maz
Grid-No.1 (CONTROL-GRID) VOLTAGE:		
Positive-bias value.....	0 maz	0 maz
Peak negative value.....	-175 maz	-175 maz
Peak Cathode Current.....	300 maz	300 maz
Average Cathode Current.....	20 maz	20 maz
Grid-No.2 Input.....	0.55 maz	0.55 maz
Plate Dissipation.....	2.5 maz	2.5 maz
Peak Heater-Cathode Voltage:		
Heater negative with respect to cathode.....	200 maz	200 maz
Heater positive with respect to cathode.....	200 ^{ma} maz	200 ^{ma} maz
The dc component must not exceed 100 volts.		

Maximum Circuit Values:

Grid-No.1-Circuit Resistance:	2.2 maz	2.2 maz	2.2 maz	megohms
For fixed-bias operation.....	2.2 maz	2.2 maz	2.2 maz	megohms
For cathode-bias operation.....				

AVERAGE CHARACTERISTICS

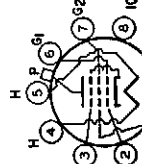
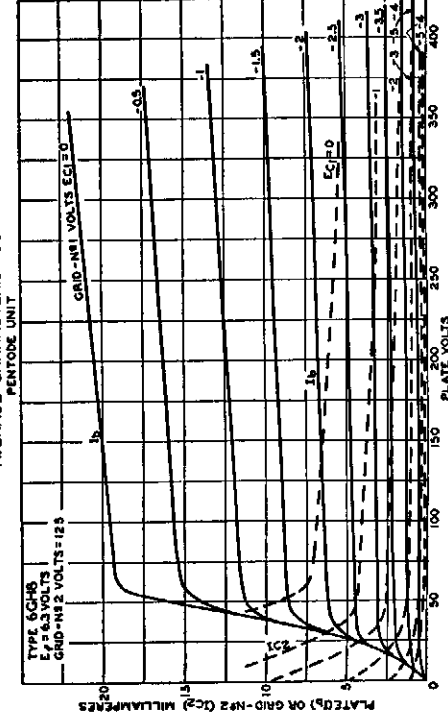

BEAM POWER TUBE

Novar type used in high-efficiency horizontal-deflection-amplifier circuits of television receivers. Outline 18A, OUTLINES SECTION. Tube requires novar nine-contact socket and may be operated in any position. For curve of average characteristics see type 6GW6.

6GJ5

Related types: 12GJ5, 17GJ5

Heater Voltage (ac/dc).....	6.3	volts
Heater Current.....	1.26	amperes
Direct-Heater-Cathode Capacitances (Approx.):		
Grid-No.1 to Plate.....	0.26	pf
Grid No.1 to Cathode, Heater, Grid No.2, and Grid No.3.....	15	pf
Plate to Cathode, Heater, Grid No.2, and Grid No.3.....	6.3	pf

CLASS A₁ AMPLIFIER

	Triode Connection	Pentode Connection
Plate Voltage.....	150	60
Grid-No.2 Voltage.....	150	250
Grid-No.1 Voltage.....	150	150
Mu-Factor, grid No.2 to grid No.1.....	-22.5	0
Plate Resistance (Approx.).....	4.4	—
Transconductance.....	—	15000
Plate Current.....	—	70
Grid-No.2 Current.....	—	390 ^u
Grid-No.1 Voltage for plate current of 1 ma.....	—	32 ^u

HORIZONTAL-DEFLECTION AMPLIFIER

For operation in a 525-line, 30-frame system

	Maximum Ratings, (Design-Maximum Values):
DC Plate Supply Voltage.....	770 maz
Peak Positive-Pulse Plate Voltage*.....	6500 maz
Peak Negative-Pulse Plate Voltage.....	-1800 maz
DC Grid-No.2 Voltage.....	220 maz
DC Grid-No.1 Voltage.....	-55 maz
Peak Negative-Pulse Grid-No.1 Voltage.....	-890 maz
Peak Cathode Current.....	550 maz
Average Cathode Current.....	175 maz
Plate Dissipation*.....	17.5 maz
Grid-No.2 Input.....	3.5 maz
Peak Heater-Cathode Voltage:	
Heater negative with respect to cathode.....	200 maz
Heater positive with respect to cathode.....	200 ^{ma} maz
Bulb Temperature (At hottest point).....	240 maz
°C.....	

Maximum Circuit Values:

Grid-No.1-Circuit Resistance:	1 maz	megohm
For fixed-resistor-bias operation*.....		
This value can be measured by a method involving a recurrent waveform such that the maximum ratings of the tube will not be exceeded.		
* The duration of the voltage pulse must not exceed 15 per cent of one horizontal scanning cycle. In a 525-line, 30-frame system, 18 per cent of one horizontal scanning cycle is 10 microseconds.		
An adequate bias resistor or other means is required to protect the tube in the absence of excitation.		
The dc component must not exceed 100 volts.		

MEDIUM-MU TRIODE—SHARP-CUTOFF PENTODE

Miniature type used as oscillator in horizontal deflection circuits of television receivers. OUTLINES SECTION. Tube requires miniature nine-contact socket and may be operated in any position. Heater volts in series: 6.3; amperes, 0.3. Heater volts in parallel: 3.15; amperes, 0.6. Heater warm-up time (average), 11 seconds. Characteristics as class A₁ Amplifier, triode unit; plate volts, 125; grid volts, -1; amplification factor, 40; plate resistance (approx.), 5000 ohms; transconductance, 8500 amhos; plate ma, 18.5; pentode unit; plate, grid-No.2 volts, 125; grid-No.1 volts, -1; plate resistance (approx.), 150,000 ohms; transconductance, 7500 μ mhos; plate ma, 12; grid-No.2 ma, 4.5. Maximum ratings as horizontal-deflection oscillator (design-maximum values), triode unit; plate volts, 330 maz; grid volts, positive-bias value, 0 maz; plate dissipation, 2.5 maz watts; pentode unit; plate, grid-No.2 volts, 330 maz; grid No.1, positive-bias value, 0 maz; grid No.1, positive-bias value, 0 maz volts; plate dissipation, 2.5 maz watts. This is a DISCONTINUED TYPE listed for reference purposes only.

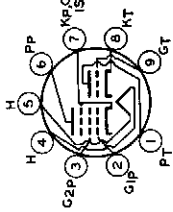

6GJ8

HIGH-MU TRIODE

Miniature type with frame grid used as a vhf tuners of television receiver tube in vhf tuners of television receivers. Outline 7B, OUTLINES SECTION. Tube requires miniature seven-contact socket and may be operated in any position.

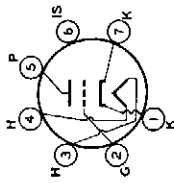

6GK5

Related types: 2GK5, 3GK5

HEATER VOLTAGE (AC/DC).....	6.3	volts
HEATER CURRENT.....	0.18	ampere
DIRECT INTERELECTRODE CAPACITANCES (Approx.): ^o		
Grid to Plate.....	0.52	pf
Grid to Cathode, Heater, and Internal Shield.....	8.5	pf
Plate to Cathode, Heater, and Internal Shield.....	8.5	pf
Heater to Cathode.....	2.5	pf

CLASS A₁ AMPLIFIER

Maximum Ratings, (Design-Maximum Values):

PLATE VOLTAGE.....	200 maz	volts
GRID VOLTAGE.....	-50 maz	volts
Negative-bias value.....	0 maz	volts
Positive-bias value.....	22 maz	volts
AVERAGE CATHODE CURRENT.....	2.5 maz	ma
PLATE DISSIPATION.....	100 maz	watts
PEAK HEATER-CATHODE VOLTAGE.....	100 maz	volts
Heater negative with respect to cathode.....	100 maz	volts
Heater positive with respect to cathode.....		

Characteristics:

Plate Voltage.....	135	volts
Grid Voltage.....	-1	volt
Amplification Factor.....	78	
Plate Resistance (Approx.).....	5400	ohms
Transconductance.....	15000	μmhos
Plate Current.....	11.5	ma
Grid Voltage (Approx.) for transconductance of 1500 μmhos.....	-4.2	volts
Grid Voltage (Approx.) for transconductance of 1500 μmhos.....	-2.5	volts
Input Resistance.....	275	ohms
Input Capacitance ^o	11.2	μmf
Noise Figure.....	4.7	db

Maximum Circuit Values:

- Grid-Circuit Resistance: For cathode-bias operation..... 1 maz megohm
- o With external shield connected to cathode, except as noted.
- o With external shield and internal shield connected to ground.
- o Measured at 200 Mc with heater volts = 6.3 and plate effectively grounded for rf voltages.
- o For a neutralized triode amplifier at a frequency of 200 Mc with signal source impedance adjusted for minimum noise output.

AVERAGE PLATE CHARACTERISTICS

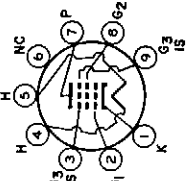
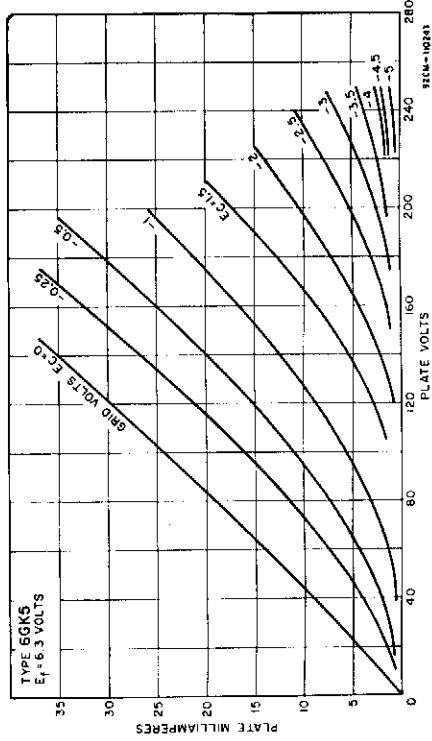

POWER PENTODE

Miniature type used in the output stage of audio amplifying equipment and also in the video output stage of television receivers. Outline 8E, OUTLINES SECTION. Tube requires miniature nine-contact socket and may be operated in any position.

6GK6

HEATER VOLTAGE (AC/DC).....	6.3	volts
HEATER CURRENT.....	0.76	ampere
DIRECT INTERELECTRODE CAPACITANCES:		
Grid No.1 to Plate.....	0.14 maz	pf
Grid No.1 to Cathode, Heater, Grid No.2, Grid No.3, and Internal Shield.....	10	pf
Plate to Cathode, Heater, Grid No.2, Grid No.3, and Internal Shield.....	7	pf

CLASS A₁ AMPLIFIER

Maximum Ratings, (Design-Maximum Values):

PLATE SUPPLY VOLTAGE.....	600 maz	volts
PLATE VOLTAGE.....	330 maz	volts
GRID-No.2 SUPPLY VOLTAGE.....	605 maz	volts
GRID-No.2 (SCREEN-GRID) VOLTAGE.....	330 maz	volts
GRID-No.1 (CONTROL-GRID) VOLTAGE, Negative-bias value.....	-100 maz	volts
CATHODE CURRENT.....	65 maz	ma
PLATE DISSIPATION.....	13.2 maz	watts
GRID-No.2 INPUT, Peak.....	4 maz	watts
GRID-No.2 INPUT, Average.....	2 maz	watts
PEAK HEATER-CATHODE VOLTAGE.....	100 maz	volts
Heater negative with respect to cathode.....	100 maz	volts
Heater positive with respect to cathode.....		

Characteristics and Typical Operation:

Plate Supply Voltage.....	250	volts
Grid-No.2 Supply Voltage.....	250	volts
Cathode-Bias Resistor.....	136	ohms
μ _o -Factor, Grid No.2 to Grid No.1.....	19	
Plate Resistance (Approx.).....	38000	ohms
Transconductance.....	19800	μmhos
Peak A-F Grid-No.1 Voltage.....	7.3	volts
Zero-Signal Plate Current.....	46	ma
Maximum-Signal Plate Current.....	50.5	ma
Zero-Signal Grid-No.2 Current.....	9.0	ma
Maximum-Signal Grid-No.2 Current.....	10	ma
Effective Load Resistance.....	5200	ohms
Total Harmonic Distortion.....	1.0	per cent
Maximum-Signal Power Output.....	5.7	watts

PUSH-PULL CLASS AB₁ and B AMPLIFIER

Maximum Ratings: (Same as for class A₁ amplifier)

Typical Operation, (Values are for two tubes):

Plate Voltage.....	250	300	Class B
Grid-No.1 Voltage.....	250	300	250
Cathode-Bias Resistor.....	130	180	11.6
Peak A-F Grid-No.1-to-Grid-No.1 Voltage.....	22.4	28	22.4
Zero-Signal Plate Current.....	62	72	20
Maximum-Signal Plate Current.....	75	92	75
Zero-Signal Grid-No.2 Current.....	7	8	2.2
Maximum-Signal Grid-No.2 Current.....	15	22	15
Effective Load Resistance (plate to plate).....	8000	8000	8000
Total Harmonic Distortion.....	3	4	3
Maximum-Signal Power Output.....	11	17	11

AVERAGE CHARACTERISTICS

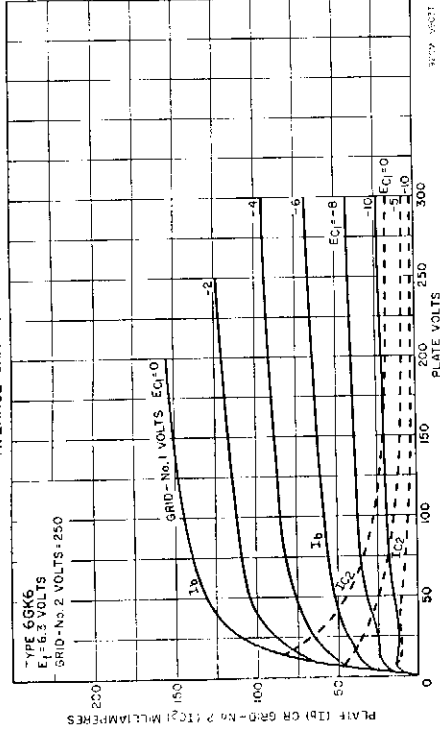

Maximum Circuit Values:

Grid-No.1-Circuit Resistance: For fixed-bias operation. For cathode-bias operation.

0.3 maz megohm
1 maz megohm

DUAL TRIODE

Glass type containing high-mu triode and high-perveance, low-mu triode in same envelope. Used as combined vertical-deflection-oscillator and vertical-deflection-amplifier tube in television receivers. Outline 14B, OUTLINES SECTION. Tube requires octal socket and may be mounted in any position. Heater volts (ac/dc), 6.3; amperes, 1.05.

6GL7

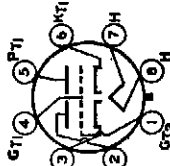

CLASS A₁ AMPLIFIER

Characteristic	Unit No.1	Unit No.2	Unit No.3
Plate Voltage	250	175	volts
Grid Voltage	-3	-25	volts
Amplification Factor	66	5	
Plate Resistance (Approx.)	30000	780	ohms
Transconductance	2200	6400	μmhos
Grid Voltage (Approx.): For plate current of 20 μa	-5.3		volts
For plate current of 200 μa	-60		volts
Plate Current	2	46	ma

VERTICAL-DEFLECTION OSCILLATOR AND AMPLIFIER

For operation in a 525-line, 30-frame system

Characteristic	Unit No.1	Unit No.2
DC Plate Voltage	350 maz	550 maz
Peak Positive-Pulse Plate Voltage	1500 ^{ma} maz	1500 ^{ma} maz
Peak Negative-Pulse Grid Voltage	-400 maz	175 maz
Peak Cathode Current	1 maz	50 maz
Average Cathode Current	1 maz	10 maz
Plate Dissipation*	200 maz	200 maz
Heater negative with respect to cathode	200 ^{ma} maz	200 ^{ma} maz
Heater positive with respect to cathode	200 ^{ma} maz	200 ^{ma} maz

Maximum Circuit Values:

Grid-Circuit Resistance: For fixed-bias operation. For cathode-bias operation. The duration of the voltage pulse must not exceed 15 per cent of one vertical scanning cycle. In a 525-line, 30-frame system, 15 per cent of one vertical scanning cycle is 2.5 milliseconds. An adequate bias resistor or other means is required to protect the tube in the absence of excitation. The dc component must not exceed 100 volts.

SEMIREMOTE-CUTOFF PENTODE

Miniature type used in gain-controlled picture-if stages of television receivers operating at intermediate frequencies in the order of 40 megacycles. Tube features high transconductance and relatively low capacitances. Outline 7B, OUTLINES SECTION. Tube requires seven-contact socket and may be mounted in any position.

6GM6

Related type: 5GM6

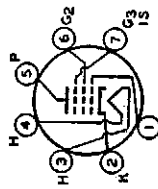

Heater Voltage (AC/DC)	Heater Current	Direct Interelectrode Capacitances:
6.3	0.4	Grid No.1 to Plate
		Grid No.1 to Cathode, Heater, Grid No.2, Grid No.3, and Internal Shield
		Plate to Cathode, Heater, Grid No.2, Grid No.3, and Internal Shield

Direct Interelectrode Capacitances:

Without External Shield	With External Shield
0.036 maz	0.026 maz
10	10
2.4	3.4

CLASS A₁ AMPLIFIER

Maximum Ratings, (Design-Maximum Values):

Plate Voltage: 380 maz
Grid-No.3 (Suppressor-Grid) Voltage, Positive Value: 0 maz
Grid-No.2 (Screen-Grid) Supply Voltage: 380 maz
Grid-No.2 Voltage: See curve page 70
Grid-No.1 (Control-Grid) Voltage, Positive-Bias Value: 0 maz
Plate Dissipation: 3.1 maz
Grid-No.2 Input: 0.65 maz
For Grid-No.2 voltages up to 165 volts. For Grid-No.2 voltages between 165 and 380 volts.
Peak Heater-Cathode Voltage: Heater negative with respect to cathode. Heater positive with respect to cathode.

Characteristics:

Plate Supply Voltage: 125
Grid No.3: Connected to cathode at socket
Grid-No.2 Supply Voltage: 125
Cathode-Bias Resistor: 56
Plate Resistance (Approx.): 0.2
Transconductance (Approx.): 13000
Grid-No.1 Voltage (Approx.) for transconductance of 60 μmhos: -15
Plate Current: 14
Grid-No.2 Current: 3.4
* With external shield connected to cathode.
* The dc component must not exceed 100 volts.

AVERAGE CHARACTERISTICS

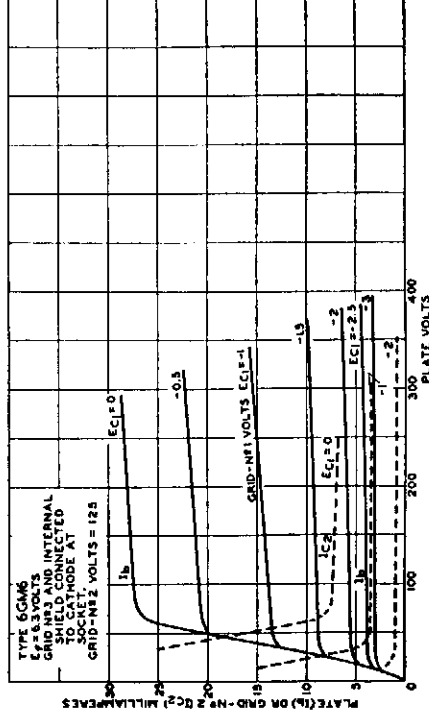

HIGH-MU TRIODE—SHARP-CUTOFF PENTODE

Miniature type used in color and black-and-white television receivers. Triode unit is used as sync-separator, sync-clipper, phase inverter, or sound-if amplifier. Pentode unit is used in output stage of video amplifier. Outline 8D, OUTLINES SECTION. Tube requires miniature nine-contact socket and may be operated in any position. For direct inter-electrode capacitances, refer to type 6EB8; curve for average plate characteristics of triode unit is same as for type 6EB8. Heater volts (ac/dc), 6.3; amperes, 0.75.

6GN8

Related types: 8GN8, 1C5N8

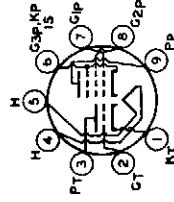

CLASS A₁ AMPLIFIER

Maximum Ratings, (Design-Maximum Values):

Plate Voltage: 330 maz
Grid-No.2 (Screen-Grid) Supply Voltage: 330 maz
Grid-No.2 Voltage: —
* See curve page 70

GRID-NO.1 (CONTROL-GRID) VOLTAGE, Positive-bias value...... 0 maz
PLATE DISSIPATION...... 0 maz
GRID-NO.2 INPUT...... 1 maz
 For grid-No.2 voltages up to 165 volts. 1.1 maz
 For grid-No.2 voltages between 165 and 380 volts. See curve page 70
PEAK HEATER-CATHODE VOLTAGE:
 Heater negative with respect to cathode. 200 maz
 Heater positive with respect to cathode. 200⁰maz

	Triode Unit	Pentode Unit	
Characteristics:			
Plate Supply Voltage.....	250	200	volts
Grid-No.2 Supply Voltage.....	150	150	volts
Grid-No.1 Voltage.....	0	100	ohms
Cathode-Bias Resistor.....	100	60000	ohms
Amplification Factor.....	37000	11500	amhos
Plate Resistance (Approx.).....	2700	5	volts
Transconductance.....	5	10	volts
Grid Voltage (Approx.) for plate current of 20 μ a.....	55 ^a	25	ma
Plate Current.....	2	18 ^a	ma
Grid-No.2 Current.....			

Maximum Circuit Values:
 Grid-No.1-Circuit Resistance:
 For fixed-bias operation..... Triode Unit
 0.5 maz
 For cathode-bias operation..... Pentode Unit
 1 maz
 The dc component must not exceed 100 volts.
 This value can be measured by a method involving a recurrent waveform such that the maximum ratings of the tube will not be exceeded.

AVERAGE CHARACTERISTICS

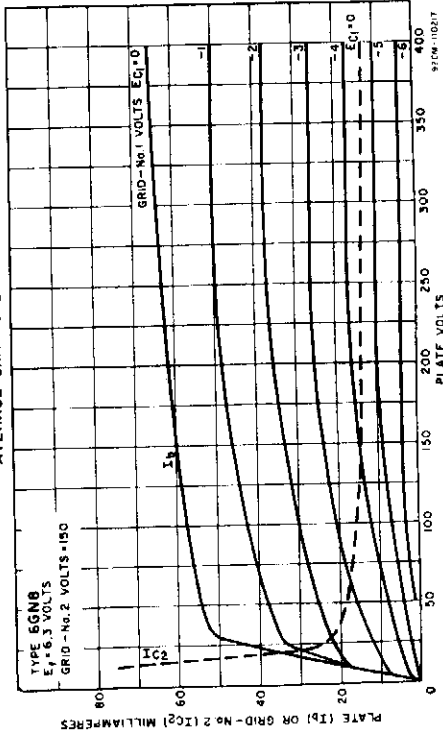

BEAM POWER TUBE

Novar type used as a horizontal-deflection amplifier in television receivers. Outline 17A, OUTLINES SECTION. Tube requires novar nine-contact socket and may be mounted in any position. For curve of average characteristics, refer to type 6GW6.

6GT5

Related types:
 12GT5, 17GT5

HEATER VOLTAGE (AC/DC).....	6.3	volts
HEATER CURRENT.....	1.2	amperes
DIRECT INTERELECTRODE CAPACITANCES (Approx.):		
Grid No.1 to Plate.....	0.26	pf
Grid No.1 to Cathode, Heater, Grid No.2, and Grid No.3.....	15	pf
Plate to Cathode, Heater, Grid No.2, and Grid No.3.....	6.5	pf

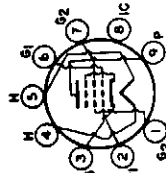

CLASS A1 AMPLIFIER

Characteristics:	Triode Connection	Pentode Connection	
Plate Voltage.....	150	60	250
Grid-No.2 (Screen-Grid) Voltage.....	150	150	volts
Grid-No.1 (Control-Grid) Voltage.....	0	0	150
Mu Factor, grid No.2 to grid No.1.....	4.4	4.4	-22.5
Plate Resistance (Approx.).....			15000
Transconductance.....			7100
Grid-No.2 Current.....			70
Grid-No.1 Current.....			2.1
Grid-No.1 Voltage (Approx.) for plate ma=1.....			32*

HORIZONTAL-DEFLECTION AMPLIFIER

For operation in a 525-line, 80-frame system

Maximum Ratings, (Design-Maximum Values):

DC PLATE SUPPLY VOLTAGE.....	770 maz
PEAK POSITIVE-PULSE PLATE VOLTAGE ^a	6500 maz
PEAK NEGATIVE-PULSE PLATE VOLTAGE.....	-1500 maz
DC GRID-NO.2 VOLTAGE.....	220 maz
DC GRID-NO.1 VOLTAGE.....	-55 maz
PEAK NEGATIVE-PULSE GRID-NO.1 VOLTAGE.....	-330 maz
PEAK CATHODE CURRENT.....	550 maz
AVERAGE CATHODE CURRENT.....	175 maz
GRID-NO.2 INPUT.....	3.5 maz
PEAK HEATER-CATHODE VOLTAGE: Heater negative with respect to cathode.....	200 maz
Heater positive with respect to cathode.....	200 ⁰ maz
BULB TEMPERATURE (At hottest point).....	240 maz

Maximum Circuit Values:

Grid-No.1-Circuit Resistance:
 For grid-resistor-bias operation..... 1 maz megohm
 * These values can be measured by a method involving a recurrent waveform such that the plate dissipation and grid-No.2 input will not exceed their maximum ratings.
^a The duration of the voltage pulse must not exceed 15 per cent of one horizontal scanning cycle. In a 525-line, 80-frame system, 15 per cent of one horizontal scanning cycle is 10 microseconds.
 • An adequate bias resistor or other means is required to protect the tube in the absence of excitation.
 • The dc component must not exceed 100 volts.

MEDIUM-MU TWIN TRIODE

Miniature type used in the matrixing circuits of color television receivers employing series-connected heater strings. Also used in phase-inverter, multivibrator, and general-purpose-amplifier applications. Outline 8D, OUTLINES SECTION. Tube requires miniature nine-contact socket and may be mounted in any position.

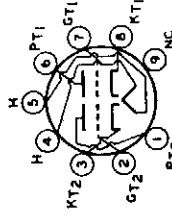

6GU7

HEATER VOLTAGE (AC/DC).....	6.3	volts
HEATER CURRENT.....	0.6	ampere
HEATER WARM-UP TIME (Average).....	11	seconds
DIRECT INTERELECTRODE CAPACITANCES (Approx.):		
Grid to Plate.....	3.4	pf
Grid to Cathode and Heater.....	3.6	pf
Plate to Cathode and Heater.....	0.44	0.34
Plate of Unit No.1 to Plate of Unit No.2.....	1	pf

CLASS A1 AMPLIFIER (Each Unit)

Maximum Ratings, (Design-Maximum Values):	
PLATE VOLTAGE.....	380 maz
GRID VOLTAGE, Positive-bias value.....	0 maz
PLATE DISSIPATION.....	3 maz
PEAK HEATER-CATHODE VOLTAGE: Heater negative with respect to cathode.....	200 maz
Heater positive with respect to cathode.....	200 ⁰ maz
Characteristics:	
Plate Voltage.....	250
Grid Voltage.....	-10.5

Amplification Factor.....	17
Plate Resistance (Approx.).....	5600 ohms
Transconductance.....	3160 μ mhos
Grid Voltage (Approx.) for plate current of 50 μ A.....	-23 volts
Plate Current.....	11.5 ma
Plate Current for grid voltage of -14 volts.....	4 ma
Maximum Circuit Values:	
Grid-Circuit Resistance:	1 megohm
For fixed-bias operation.....	
■ The dc component must not exceed 100 volts.	

AVERAGE PLATE CHARACTERISTICS

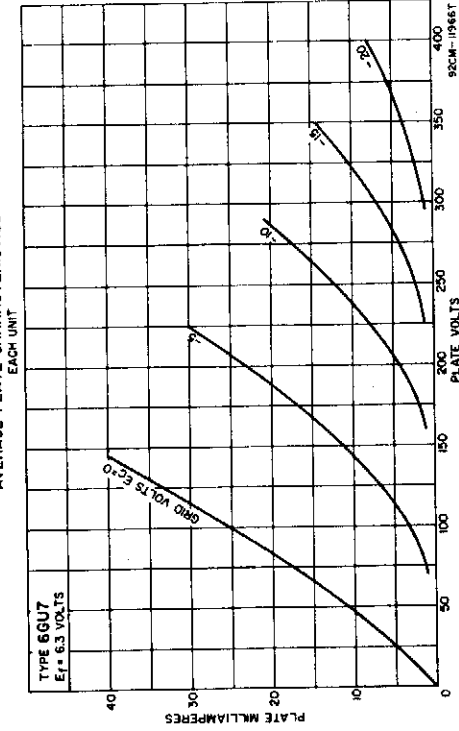

BEAM POWER TUBE

6GV5
 Related type: 17GV5
 Duodec triode type used as horizontal-deflection amplifier in television receivers. Outline 16C, OUTLINES SECTION. Tube requires duodec triode-contact socket and may be mounted in any position. Heater volts (ac/dc), 6.3; amperes, 1.2.

CLASS A₁ AMPLIFIER

Characteristics:	
Plate Voltage.....	250 volts
Grid-No.2 (Screen-Grid) Voltage.....	150 volts
Grid-No.1 (Control-Grid) Voltage.....	0 volts
Plate Resistance (Approx.).....	18000 ohms
Transconductance.....	7300 μ mhos
Triode Amplification Factor.....	4.4*
Plate Current.....	345 ma
Grid-No.2 Current.....	27 ma
Grid-No.1 Voltage (Approx.) for plate current of 1 ma.....	-100 volts

HORIZONTAL-DEFLECTION AMPLIFIER

For operation in a 535-line, 50-frame system

Maximum Ratings, (Design-Maximum Values):	
DC Plate Supply Voltage.....	270 max volts
Peak Positive-Pulse Plate Voltage.....	6500 max volts
Peak Negative-Pulse Plate Voltage.....	-1600 max volts
DC Grid-No.2 Voltage.....	220 max volts

PEAK NEGATIVE-PULSE GRID-NO.1 VOLTAGE.....	-330 max volts
DC GRID-NO.1 VOLTAGE.....	-55 max volts
PEAK CATHODE CURRENT.....	550 max ma
AVERAGE CATHODE CURRENT.....	175 max ma
PLATE DISSIPATION.....	17.5 max watts
GRID-NO.2 INPUT.....	3.5 max watts
PEAK HEATER-CATHODE VOLTAGE:	
Heater negative with respect to cathode.....	200 max volts
Heater positive with respect to cathode.....	200* max volts
BULB TEMPERATURE (At hottest point).....	200 max °C

Maximum Circuit Values:

Grid-No.1-Circuit Resistance..... 1 megohm
 *Grid No.2 tied to plate; plate and grid-No.2 volts, 150; grid-No.1 volts, -22.5.
 †This value can be measured by a method involving a recurrent waveform such that the maximum ratings of the tube will not be exceeded.
 ‡The duration of the voltage pulse must not exceed 15 per cent of one horizontal scanning cycle. In a 525-line, 60-frame system, 15 per cent of one horizontal scanning cycle is 10 microseconds.
 †An adequate bias resistor or other means is required to protect the tube in the absence of excitation.
 *The dc component must not exceed 100 volts.

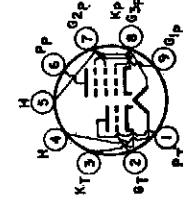

**HIGH-MU TRIODE—
 POWER PENTODE**

Miniature type used for sync-amplifier and video-output applications in television receivers. Outline 8E, OUTLINES SECTION. Tube requires miniature nine-contact socket and may be mounted in any position. Heater volts (ac/dc), 6.3; amperes, 0.9.

6GV8

CLASS A₁ AMPLIFIER

Maximum Ratings, (Absolute-Maximum Values):	
Plate Supply Voltage.....	250 max volts
Plate Plate Voltage.....	2000 max volts
DC Plate Voltage.....	250 max volts
GRID-NO.2 (SCREEN-GRID) SUPPLY VOLTAGE.....	550 max volts
GRID-NO.2 VOLTAGE.....	250 max volts
PEAK CATHODE CURRENT.....	75 max ma
AVERAGE CATHODE CURRENT.....	2 max ma
GRID-NO.2 INPUT.....	0.5 max watts
PLATE DISSIPATION.....	220 max watts
PEAK HEATER-CATHODE VOLTAGE:	
Heater negative with respect to cathode.....	220 max volts
Heater positive with respect to cathode.....	220 max volts

Characteristics:

Grid-No.2 Voltage.....	100 volts
Grid-No.1 Voltage.....	-0.8 volts
Amplification Factor.....	50
Mu-Factor, Grid No.1 to Grid No.2.....	-
Plate Resistance (Approx.).....	7600 ohms
Transconductance.....	6500 μ mhos
Plate Current.....	5 ma
Grid-No.2 Current.....	40* 50*2.7 ma

Maximum Circuit Values:

Grid-No.1-Circuit Resistance..... 1 megohm
 For fixed-bias operation..... 3.3 max
 For cathode-bias operation..... 2.2 max
 *Maximum pulse duration 5 per cent of a cycle with a maximum of 1 millisecond.
 †Maximum pulse duration 200 microseconds. If a larger flyback is required, this value may be reduced to 100 ma with a maximum pulse duration of 400 microseconds.
 ‡This value can be measured by a method involving a recurrent waveform such that the maximum tube ratings will not be exceeded.

BEAM POWER TUBE

Glass octal type used as horizontal-deflection amplifier in high-efficiency deflection circuits of television receivers. Outline 21, OUTLINES SECTION. Tube requires octal socket and may be operated in any position.

6GW6

Related types:
12GW6, 170W6

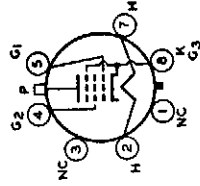

Heater Voltage (AC/DC)	6.3	volts
Heater Current	1.2	amperes
Direct Inter-electrode Capacitances (Approx.):		
Grid No.1 to Plate	0.5	pf
Grid No.1 to Cathode, Heater, Grid No.2, and Grid No.3	17	pf
Plate to Cathode, Heater, Grid No.2, and Grid No.3	7	pf
Characteristics:		
Plate Voltage	60	volts
Grid-No.2 Voltage	150	volts
Grid-No.1 Voltage	0	volts
Plate Resistance (Approx.)	15000	ohms
Transconductance	7100	μmhos
Plate Current	70	ma
Plate-No.2 Current	2.1	ma
Grid-No.1 Voltage (Approx.) for plate current of 1 ma	32*	volts
	42	

CLASS A₁ AMPLIFIER

Plate Voltage	60	volts
Grid-No.2 Voltage	150	volts
Grid-No.1 Voltage	0	volts
Plate Resistance (Approx.)	15000	ohms
Transconductance	7100	μmhos
Plate Current	70	ma
Plate-No.2 Current	2.1	ma
Grid-No.1 Voltage (Approx.) for plate current of 1 ma	32*	volts
	42	

HORIZONTAL-DEFLECTION AMPLIFIER

For operation in a 525-line, 30-frame system

Maximum Ratings, (Design-Maximum Values):		
DC Plate Supply Voltage	770 max	volts
Peak Positive-Pulse Plate Voltage*	6500 max	volts
Peak Negative-Pulse Plate Voltage	-1500 max	volts
DC Grid-No.2 (Screen-Grid) Voltage	220 max	volts
DC Grid-No.1 (Control-Grid) Voltage	-85 max	volts
Peak Negative-Pulse Grid-No.1 Voltage	-330 max	volts
Peak Cathode Current	550 max	ma
Average Cathode Current	175 max	ma
Grid-No.2 Input	3.5 max	watts
Plate Dissipation*	17.5 max	watts
Peak Heater-Cathode Voltage	200 max	volts
Heater negative with respect to cathode	200 max	volts
Heater positive with respect to cathode	240 max	volts
Bulb Temperature (At hottest point)		-4°C

Maximum Circuit Values:

Grid-No.1-Circuit Resistance	1 ma	megohm
For grid resistor-bias operation		

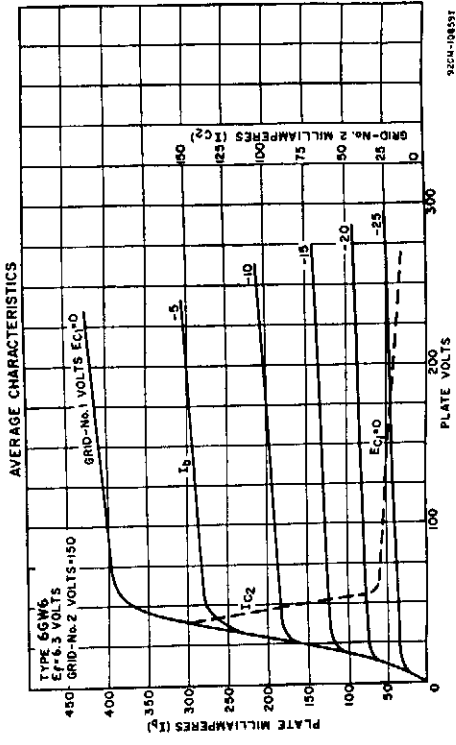

9254-10451T

* This value can be measured by a method involving a recurrent waveform such that the maximum ratings of the tube will not be exceeded.
 ■ The duration of the voltage pulse must not exceed 15 per cent of one horizontal scanning cycle. In a 525-line, 30-frame system, 15 per cent of one horizontal scanning cycle is 10 microseconds.
 ● An adequate bias resistor or other means is required to protect the tube in the absence of excitation.
 □ The dc component must not exceed 100 volts.

SHARP-CUTOFF PENTODE

Miniature type used for FM sound-detector service in locked-oscillator, quadrature-grid FM detector circuits, as combined detector, limiter, and audio-voltage driver. Tube has two independent control grids, and has controlled heater warm-up time for use in circuits employing series-connected heater strings. Outline 7B, OUTLINES SECTION. Tube requires miniature seven-contact socket and may be mounted in any position.

6GX6

Related type:
50X6

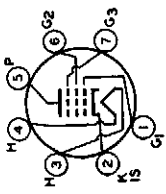

Heater Voltage (AC/DC)	6.3	volts
Heater Current	0.45	ampere
Heater Warm-Up Time (Average)	11	seconds
Direct Inter-electrode Capacitances (Approx.):		
Grid No.1 to Plate	0.025	pf
Grid No.1 to Cathode, Heater, Grid No.2, Grid No.3, and Internal Shield	8	pf
Grid No.1 to Grid No.3	0.12	pf
Grid No.3 to Plate	1.6	pf
Grid No.3 to Cathode, Heater, Grid No.1, Grid No.2, Plate, and Internal Shield	6.5	pf

CLASS A₁ AMPLIFIER

Characteristics:		
Plate Supply Voltage	150	volts
Grid-No.3 Supply Voltage	0	volts
Grid-No.2 Supply Voltage	100	volts
Grid-No.1 Supply Voltage	0	volts
Cathode-Bias Resistor	180	ohms
Plate Resistance (Approx.)	0.14	megohm
Transconductance, grid No.1 to plate	3700	μmhos
Transconductance, grid No.3 to plate	750	μmhos
Plate Current	3.7	ma
Grid-No.2 Current	3	ma
Grid-No.3 Supply Voltage (Approx.) for plate current of 20 μa	-7	volts
Grid-No.1 Supply Voltage (Approx.) for plate current of 20 μa	-4.5	volts

FM SOUND DETECTOR

Maximum Ratings, (Design-Maximum Values):		
Plate Voltage	300 max	volts
Grid-No.3 (Control-Grid) Voltage:		
Negative value (dc and peak ac)	-100 max	volts
Positive value (dc and peak ac)	25 max	volts

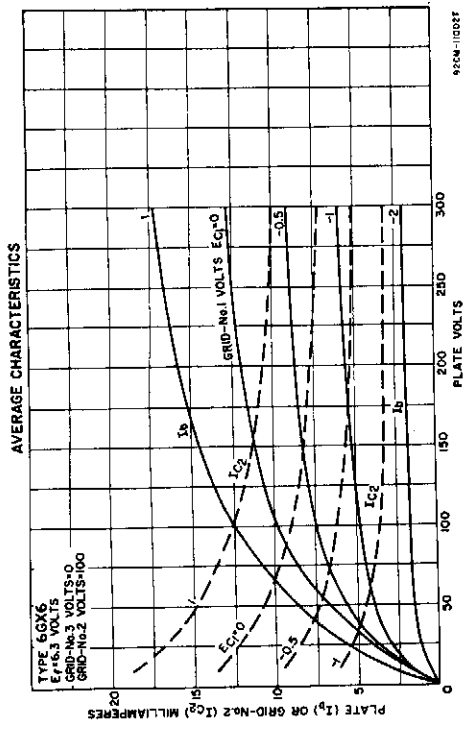

9254-11051T

GRID-NO.2 (SCREEN-GRID) SUPPLY VOLTAGE..... volts
 See curve page 70

GRID-NO.2 VOLTAGE..... volts
 -50 maz
 0 maz
 1.7 maz
 0.1 maz

GRID-NO.1 (CONTROL-GRID) VOLTAGE..... volts
 Negative-bias value
 Positive-bias value

PLATE DISSIPATION..... watt
 1.0 maz
 See curve page 70

GRID-NO.3 INPUT..... volts
 200 maz
 200* maz

GRID-NO.2 INPUT..... volts
 0.68 maz
 megohm

GRID-NO.3-Circuit Resistance..... megohm
 0.22 maz
 megohm

GRID-NO.1-Circuit Resistance..... megohm
 For fixed-bias operation
 For cathode-bias operation

■ The dc component must not exceed 100 volts.

AVERAGE CHARACTERISTICS

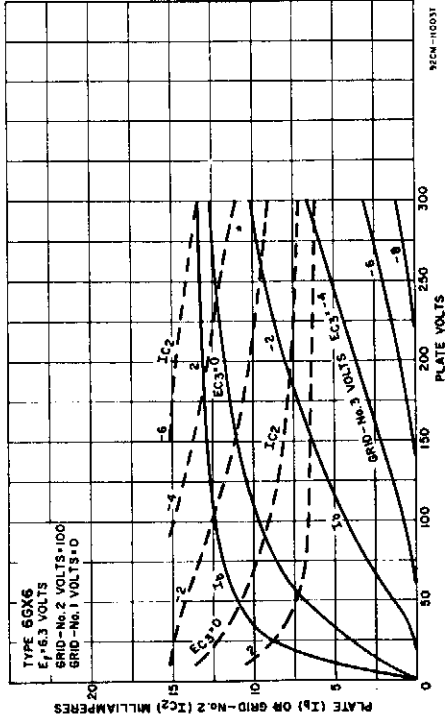

SHARP-CUTOFF PENTODE

Miniature type used in gated-agc-amplifier circuits and as a noise-inverter tube in television receivers. Tube has two independent control grids, and has controlled heater warm-up time for use in circuits employing series-connected heater strings. Outline 7B, OUTLINES SECTION. Tube requires miniature seven-contact socket and may be mounted in any position. For curves of average characteristics, refer to type 6GX6.

HEATER VOLTAGE (AC/DC)..... volts
 6.3

HEATER CURRENT..... ampere
 0.45

HEATER WARM-UP TIME (AVERAGE)..... seconds
 11

DIRECT INTERELECTRODE CAPACITANCES:

Grid No.1 to Plate..... pf
 0.026

Grid No.1 to Cathode, Heater, Grid No.2, Grid No.3, and Internal Shield..... pf
 8

Grid No.1 to Grid No.3..... pf
 0.12

Grid No.3 to Plate..... pf
 1.6

Grid No.3 to Cathode, Heater, Plate, Grid No.1, Grid No.2, and Internal Shield..... pf
 6.5

CLASS A₁ AMPLIFIER

Characteristics:

Plate Supply Voltage..... volts
 150

Grid-No.3 Supply Voltage..... volts
 0

Grid-No.2 Supply Voltage..... volts
 100

Grid-No.1 Supply Voltage..... volts
 0

Cathode-Bias Resistor..... ohms
 180

Plate Resistance (Approx.)..... ohms
 0.14

Transconductance, Grid No.3 to Plate..... μ mhos
 370.0

Plate Current..... ma
 750

Grid Current..... ma
 3.7

6GY6



Grid-No.2 Current..... ma
 3

Grid-No.3 Supply Voltage (Approx.) for plate current of 20 μ A..... volts
 -7

Grid-No.1 Supply Voltage (Approx.) for plate current of 20 μ A..... volts
 -4.5

GATED AGC AMPLIFIER AND NOISE INVERTER

For operation in a 525-line, 30-frame system

Maximum Ratings, (Design-Maximum Values):

PLATE VOLTAGE..... volts
 300 maz
 600 maz

PEAK POSITIVE-PULSE PLATE VOLTAGE..... volts
 300 maz

GRID-NO.3 (CONTROL-GRID) VOLTAGE..... volts
 -100 maz
 0 maz
 300 maz

Negative-bias value
 Positive-bias value

GRID-NO.2 (SCREEN-GRID) SUPPLY VOLTAGE..... volts
 -50 maz
 0 maz
 1.7 maz

Negative-bias value
 Positive-bias value

PLATE DISSIPATION..... watt
 1 maz

GRID-NO.2 INPUT..... watt
 See curve page 70

PEAK HEATER-CATHODE VOLTAGE..... volts
 300 maz
 200* maz

Heater negative with respect to cathode
 Heater positive with respect to cathode

Maximum Circuit Values:

Grid-No.3-Circuit Resistance..... megohm
 0.68 maz

Grid-No.1-Circuit Resistance..... megohm
 0.22 maz
 0.47 maz

For fixed-bias operation
 For cathode-bias operation

■ The duration of the voltage pulse must not exceed 15 per cent of one horizontal scanning cycle. In a 525-line, 30-frame system, 15 per cent of one horizontal scanning cycle is 10 microseconds.

■ The dc component must not exceed 100 volts.

HIGH-MU TRIPLE TRIODE

Miniature type used in rf-amplifier, mixer, and automatic-frequency-control service in FM radio receivers. Outline 8B, OUTLINES SECTION. Tube requires miniature nine-contact socket and may be operated in any position. Heater volts (ac/dc), 6.3; amperes, 0.45.

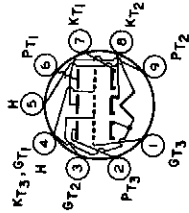

6GY8

CLASS A₁ AMPLIFIER

Values are for each unit, except as noted

Maximum Ratings, (Design-Maximum Values):

PLATE VOLTAGE..... volts
 330 maz

GRID VOLTAGE, Positive-bias value..... volts
 0 maz

PLATE DISSIPATION..... watts
 2 maz
 5 maz

TOTAL PLATE DISSIPATION (All plates)..... watts
 100 maz

PEAK HEATER-CATHODE VOLTAGE (Units No.1 and No.2):
 Heater negative with respect to cathode..... volts
 100 maz
 Heater positive with respect to cathode..... volts
 100 maz

Characteristics:

Plate Supply Voltage..... volts
 125

Grid Voltage..... volts
 195

Cathode-Bias Resistor..... ohms
 -1

Amplification Factor..... ohms
 220

Plate Resistance (Approx.)..... ohms
 63

Transconductance..... μ mhos
 14000

Plate Current..... ma
 4500

Grid Voltage (Approx.) for plate current of 20 μ A..... ma
 4.5
 -

TWIN DIODE

Metal type 6H6 and glass octal type 6H6-GT used as detectors, low-voltage rectifiers, and avc tubes. Except for the common heater, the two diode units are independent of each other. For diode detector considerations, refer to ELECTRON TUBE APPLICATIONS.

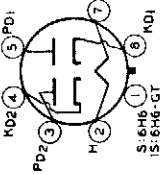

6H6
6H6GT
 Related type:
 12H6

TIONS SECTION. Type 6H6-GT is a DISCONTINUED type listed for reference only. Heater volts (ac/dc), 6.3; amperes, 0.3.

RECTIFIER OR DOUBLER

Maximum Ratings:	
PEAK INVERSE PLATE VOLTAGE.....	420 max volts
PEAK PLATE CURRENT (Per Plate).....	48 max ma
DC OUTPUT CURRENT (Per Plate).....	8 max ma
PEAK HEATER-CATHODE VOLTAGE:	
Heater negative with respect to cathode.....	330 max volts
Heater positive with respect to cathode.....	330 max volts

Typical Operation As Half-Wave Rectifier*:

AC Plate Voltage (Per Plate, rms).....	117 volts
Min. Total Effective Plate-Supply Impedance (Per Plate).....	15 ohms
DC Output Current (Per Plate).....	8 ma

Typical Operation As Voltage Doubler:

AC Plate Voltage (Per Plate, rms).....	117 volts
Min. Total Effective Plate-Supply Impedance (Per Plate) ^b	30 ohms
DC Output Current.....	8 ma

* In half-wave service, the two units may be used separately or in parallel.

^b When a filter-input capacitor larger than 40 μ f is used, it may be necessary to use more plate-supply impedance than the value shown to limit the peak plate current to the rated value.

INSTALLATION AND APPLICATION

Types 6H6 and 6H6-GT require an octal socket and may be mounted in any position. Type 6H6-GT may be supplied with pin No.1 omitted. Type 6H6 maximum dimensions: over-all length, 1-3/4 inches; seated height, 1-3/16 inches; diameter, 1-5/16 inches. Type 6H6-GT, Outline 14C, OUTLINES SECTION.

For detection, the diodes may be utilized in a full-wave circuit or in a half-wave circuit. In the latter case, one plate only, or the two plates in parallel, may be employed. For the same signal voltage, the use of the half-wave arrangement will provide approximately twice the rectified voltage as compared with the full-wave arrangement.

For automatic volume control, the 6H6 and 6H6-GT may be used in circuits similar to those employed for any of the twin-diode types of tubes. The only difference is that the 6H6 and 6H6-GT are more adaptable because each diode has its own separate cathode.

HIGH-MU TRIODE

Miniature type used as rf-amplifier tube in vhf television tuners. Outline 7A, OUTLINES SECTION, except vertical dimensions are 1/8 inch shorter. Tube requires miniature seven-contact socket and may be mounted in any position. Heater volts (ac/dc), 6.3; amperes, 0.18.

6HA5

Related type: 3HA5

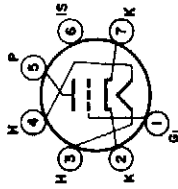

CLASS A₁ AMPLIFIER

Maximum Ratings, (Design-Maximum Values):	
DC PLATE VOLTAGE.....	220 max volts
DC PLATE SUPPLY VOLTAGE.....	600 max volts
GRID VOLTAGE.....	-50 max volts
CATHODE CURRENT.....	22 max ma
PLATE DISSIPATION.....	2.6 max watts
PEAK HEATER-CATHODE VOLTAGE:	
Heater negative with respect to cathode.....	110 max volts
Heater positive with respect to cathode.....	110 max volts

Characteristics and Typical Operation:

DC Plate Supply Voltage.....	135	135	Cathode Bias
Plate-Load Resistor.....	—	1000	5600

Internal-Shield Voltage.....	0	0	0	0	volts
DC Grid Voltage.....	-1	-2.7	—	—	ohms
Cathode-Bias Resistor.....	—	—	0	87	
Amplification Factor.....	72	—	80	72	
Transconductance.....	14500	1500	20000	14500	μ mhos
Plate Current.....	11.5	—	19	11.5	ma
DC Grid Current.....	—	—	10	—	ma
Grid-No.1 Voltage for one-per-cent transconductance.....	—	—	-5.3	-8.1	volts

POWER PENTODE

Miniature type used as vertical deflection-amplifier tube in television receivers. Outline 8E, OUTLINES SECTION. Tube requires miniature nine-contact socket and may be mounted in any position. Heater volts (ac/dc), 6.3; amperes, 0.76.

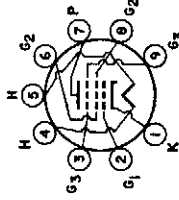

6HB6

Related type: 15HB6

Characteristics:				
Plate Supply Voltage.....	60	250	250	volts
Grid No.3.....	—	Connected to cathode at socket	—	volts
Grid-No.2 Supply Voltage.....	250	125	250	volts
Grid-No.1 Voltage.....	0	—	—	volts
Cathode-Bias Resistor.....	—	33	100	ohms
Min-Factor, Grid No.2 to Grid No.1.....	—	—	33	
Plate Resistance (Approx.).....	—	28000	24000	ohms
Transconductance.....	—	24000	20000	μ mhos
Plate Current.....	150*	40	40	ma
Grid-No.2 Current.....	37*	4.2	6.2	ma
Grid-No.1 Voltage (Approx.) for plate current of 100 μ a.....	—	-6.4	-13	volts

VERTICAL-DEFLECTION AMPLIFIER

For operation in 525-line, 30-frame system

(Design-Maximum Values):

Maximum Ratings, (Design-Maximum Values):	
DC PLATE VOLTAGE.....	350 max volts
DC GRID-No.2 (SCREEN-GRID) VOLTAGE.....	2500 max volts
DC GRID-No.1 (CONTROL-GRID) VOLTAGE.....	300 max volts
GRID-No.2 INPUT.....	-100 max volts
PLATE DISSIPATION.....	2 max watts
PEAK HEATER-CATHODE VOLTAGE:	
Heater negative with respect to cathode.....	10 max volts
Heater positive with respect to cathode.....	200 max volts

Maximum Circuit Values:

Grid-No.1-Circuit Resistance:

For fixed-bias operation.....

For cathode-bias operation.....

* This value can be measured by a method involving a recurrent waveform such that the maximum tube ratings will not be exceeded.

^b The duration of the voltage pulse must not exceed 15 per cent of one vertical scanning cycle. In a 525-line, 30-frame system, 15 per cent of one vertical-scanning cycle is 2.5 milliseconds.

^c The dc component must not exceed 100 volts.

BEAM POWER TUBE

Duodecar type used as vertical-deflection amplifier in television receivers. Outline 12D, OUTLINES SECTION. Tube requires duodecar twelve-contact socket and may be mounted in any position. Heater volts (ac/dc), 6.3; amperes, 0.8.

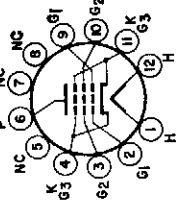

CLASS A₁ AMPLIFIER

Characteristics:		
Plate Voltage.....	60	250
Grid-No.2 (Screen-Grid) Voltage.....	250	250

Grid-No.1 (Control-Grid) Voltage.....	0
Plate Resistance (Approx.).....	50000
Transconductance.....	4100
Plate Current.....	180*
Grid-No.2 Current.....	26*
Grid-No.1 Voltage (Approx.) for plate current of 100 μ a.....	-

VERTICAL DEFLECTION AMPLIFIER

For operation in a 525-line, 30-frame system

Maximum Ratings, (Design-Maximum Values):	
DC Plate Voltage.....	350 max
Peak Positive-Pulse Plate Voltage#.....	2500 max
Grid-No.2 Voltage.....	300 max
Peak Cathode Current.....	260 ma
Average Cathode Current.....	75 ma
Plate Dissipation.....	12 maz
Grid-No.2 Input.....	2.75 maz
Heater-Cathode Voltage:	
Heater negative with respect to cathode.....	200 maz
Heater positive with respect to cathode.....	200* maz
Bulb Temperature (At hottest point).....	200 maz

Maximum Circuit Values:

Grid-No.1-Circuit Resistance.....	1 maz
For fixed-bias operation.....	2.2 maz
For cathode-bias operation.....	2.2 maz

This value can be measured by a method involving a recurrent waveform such that the maximum ratings of the tube will not be exceeded.

The duration of the voltage pulse must not exceed 15 per cent of one vertical scanning cycle. In a 525-line, 30-frame system, 15 per cent of one vertical scanning cycle is 2.5 milliseconds.

An adequate bias resistor or other means is required to protect the tube in the absence of excitation.

The dc component must not exceed 100 volts.

BEAM POWER TUBE

Duodec type used as horizontal-deflection amplifier in color television receivers. Outline 16D, OUTLINES SECTION. Tube requires duodec twelve-contact socket and may be mounted in any position. Heater voltage (ac/dc), 6.3; amperes, 2.25.

6HF5

Characteristics:	
Plate Voltage.....	5000
Grid-No.2 (Screen-Grid) Voltage.....	70
Grid-No.1 (Control-Grid) Voltage.....	125
Triode Amplification Factor.....	0
Plate Resistance (Approx.).....	3*
Transconductance.....	5600
Plate Current.....	11300
Grid-No.2 Current.....	125
Grid-No.1 Voltage (Approx.) for plate current of 1 ma.....	34*
Grid-No.1 Voltage (Approx.) for plate current of 100 μ a.....	-140

Plate Voltage.....	175
Grid-No.2 Supply Voltage.....	125
Grid-No.1 Voltage.....	-25
Cathode-Bias Resistor.....	3*
Amplification Factor.....	5600
Transconductance.....	11300
Plate Current.....	125
Grid-No.2 Current.....	4.5
Grid-No.1 Voltage (Approx.) for plate current of 20 μ a.....	-54

HORIZONTAL-DEFLECTION AMPLIFIER

For operation in a 525-line, 30-frame system

Maximum Ratings, (Design-Maximum Values):	
DC Plate Supply Voltage.....	900 maz
Peak Positive-Pulse Plate Voltage# (Absolute Maximum).....	7500* maz
Peak Negative-Pulse Plate Voltage.....	-1100 maz
DC Grid-No.2 Voltage.....	180 maz
Peak Negative-Pulse Grid-No.1 Voltage.....	-250 maz
Average Cathode Current.....	1100 maz
Plate Dissipation.....	315 maz
Grid-No.2 Input.....	28 maz
Heater-Cathode Voltage:	
Heater negative with respect to cathode.....	200 maz
Heater positive with respect to cathode.....	225* maz
Bulb Temperature (At hottest point).....	225 maz

Maximum Circuit Values:

Grid-No.1-Circuit Resistance.....	1 maz
Grid No.2 tied to plate; plate and grid-No.2 volts, 125; grid-No.1 volts, -25.....	

This value can be measured by a method involving a recurrent waveform such that the maximum ratings of the tube will not be exceeded.

The duration of the voltage pulse must not exceed 15 per cent of one horizontal scanning cycle. In a 525-line, 30-frame system, 15 per cent of one horizontal scanning cycle is 10 microseconds.

Under no circumstances should this absolute value be exceeded.

An adequate bias resistor or other means is required to protect the tube in the absence of excitation.

The dc component must not exceed 100 volts.

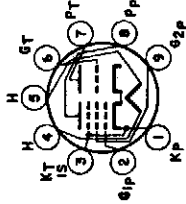
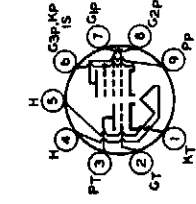

HIGH-MU TRIODE—SHARP-CUTOFF PENTODE

Miniature type used in color and black-and-white television receivers. The triode unit is used in high-gain, sound-if stages and in sync-separator, sync-clipper, and phase-inverter circuits; pentode unit is used as video-output amplifier. Outline 8D, OUTLINES SECTION. Tube requires miniature nine-contact socket and may be operated in any position. For curves of average characteristics, refer to type 6AW8-A for the triode unit and to type 6EB8 for the pentode unit.

Heater Voltage (ac/dc).....	6.3
Heater Current.....	0.75
Direct Inter-Electrode Capacitances:	
Triode Unit:	
Grid to Plate.....	3.5 pf
Grid to Cathode, Heater, Pentode Cathode, Grid No.3, and Internal Shield.....	2.8 pf
Plate to Cathode, Heater, Pentode Cathode, Grid No.3, and Internal Shield.....	2.6 pf
Pentode Unit:	
Grid No.1 to Plate.....	0.1 maz
Grid No.1 to Cathode, Heater, Grid No.2, Grid No.3, and Internal Shield.....	10
Plate to Cathode, Heater, Grid No.2, Grid No.3, and Internal Shield.....	4.2
Triode Grid to Pentode Plate.....	0.015 maz

CLASS A₁ AMPLIFIER

Maximum Ratings, (Design-Maximum Values):

Plate Voltage.....	380 maz
Grid-No.2 (Screen-Grid) Supply Voltage.....	380 maz
Grid-No.2 Voltage.....	See curve page 70
Grid-No.1 (Control-Grid) Voltage, Positive-bias value.....	0 maz
Plate Dissipation.....	1 maz
Grid-No.2 Input:	
For grid-No.2 voltages up to 165 volts.....	1.1 maz
For grid-No.2 voltages between 165 and 380 volts.....	See curve page 70
Plate Heater-Cathode Voltage:	
Heater negative with respect to cathode.....	200 maz
Heater positive with respect to cathode.....	200* maz

Characteristics:

Plate Supply Voltage.....	200
Grid-No.2 Supply Voltage.....	45
Grid-No.1 Voltage.....	125
Cathode-Bias Resistor.....	0
Amplification Factor.....	-2
Plate Resistance (Approx.).....	70
Transconductance.....	17500
Plate Current.....	4000
Grid-No.2 Current.....	4
Grid-No.1 Voltage (Approx.) for plate current of 100 μ a.....	-
Grid-No.1 Voltage (Approx.) for plate current of 20 μ a.....	-6

Maximum Circuit Values:

Grid-No.1-Circuit Resistance.....	0.5 maz
For fixed-bias operation.....	1 maz
For cathode-bias operation.....	0.25 maz

* This value can be measured by a method involving a recurrent waveform such that the maximum ratings of the tube will not be exceeded.

The dc component must not exceed 100 volts.

MEDIUM-MU TRIODE—SHARP-CUTOFF PENTODE

Miniature type with frame-grid pentode unit used as combined oscillator and mixer tube in vhf television receivers. Outline 8B, OUTLINES SECTION. Tube requires miniature

6HG8

nine-contact socket and may be mounted in any position. Heater volts (ac/dc), 6.3; amperes, 0.34.

CLASS A₁ AMPLIFIER

Maximum Ratings, (Design-Maximum Values):	
PLATE VOLTAGE.....	250 maz
GRID-NO.2 (SCREEN-GRID) VOLTAGE.....	150 maz
CATHODE CURRENT.....	18 maz
PLATE DISSIPATION.....	2 maz
GRID-NO.2 INPUT.....	0.5 maz
PEAK HEATER-CATHODE VOLTAGE: Heater negative with respect to cathode.....	100 maz
Heater positive with respect to cathode.....	100 maz
Characteristics:	
Plate Voltage.....	170 volts
Grid-No.2 Voltage.....	150 volts
Grid-No.1 (Control-Grid) Voltage.....	-1.2 volts
Amplification Factor.....	17
Mu-Factor, Grid No.2 to Grid No.1.....	70
Plate Resistance (Approx.).....	0.35 megohm
Transconductance.....	12000 μ mhos
Plate Current.....	14 ma
Grid-No.2 Current.....	3.3 ma

Maximum Circuit Values:

Grid-No.1-Circuit Resistance: For fixed-bias operation.....	0.25 maz
For cathode-bias operation.....	0.5 maz

DIODE—
SHARP-CUTOFF PENTODE

Miniature type used as combined video-detector and if-amplifier tube in television receivers employing series-connected heater strings. Outline 8B, OUTLINES SECTION. Tube requires miniature nine-contact socket and may be mounted in any position. Heater volts (ac/dc), 6.3; amperes, 0.45; warm-up time (average), 11 seconds.

6HJ8

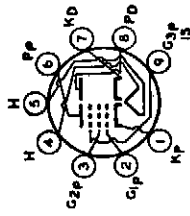

PENTODE UNIT AS CLASS A₁ AMPLIFIER

Maximum Ratings, (Design-Maximum Values):	
PLATE VOLTAGE.....	330 maz
GRID-NO.2 (SCREEN-GRID) SUPPLY VOLTAGE.....	330 maz
GRID-NO.2 VOLTAGE.....	See curve page 70
GRID-NO.1 (CONTROL-GRID) VOLTAGE, Positive-bias value.....	0 maz
GRID-NO.2 INPUT: For grid-No.2 voltages up to 165 volts.....	0.55 maz
For grid-No.2 voltages between 165 and 330 volts.....	See curve page 70
PEAK HEATER-CATHODE VOLTAGE: Heater negative with respect to cathode.....	200 maz
Heater positive with respect to cathode.....	200 ^m maz
Characteristics:	
Plate Supply Voltage.....	125 volts
Grid No.3.....	Connected to cathode at socket
Grid-No.2 Supply Voltage.....	125 volts
Cathode-Bias Resistor.....	56 ohms
Plate Resistance (Approx.).....	0.2 megohm
Transconductance.....	9800 μ mhos
Plate Current.....	11.5 ma
Grid-No.2 Current.....	3.6 ma
Grid-No.1 Voltage (Approx.) for plate current of 20 μ a.....	-6 volts
Grid-No.1 Voltage (Approx.) for plate current of 2 ma and no cathode-bias resistor.....	-8 volts

Maximum Ratings, (Design-Maximum Values):	
DC PLATE CURRENT.....	5 maz
PEAK HEATER-CATHODE VOLTAGE: Heater negative with respect to cathode.....	200 maz
Heater positive with respect to cathode.....	200 ^m maz
Characteristics, Instantaneous Value:	
Tube Voltage Drop for plate current of 30 ma.....	10 volts
The dc component must not exceed 100 volts.....	

MEDIUM-MU TRIODE—
SHARP-CUTOFF PENTODE

Miniature type used in a wide variety of applications in television receivers employing series-connected heater strings. The triode unit is used as a sync-separator or voltage-amplifier tube, and the pentode unit is used as a video if-amplifier, agc-amplifier, or receiver tube. Outline 8B, OUTLINES SECTION. Tube requires miniature nine-contact socket and may be mounted in any position. Heater volts (ac/dc), 6.3; amperes, 0.6; warm-up time (average), 11 seconds.

6HL8

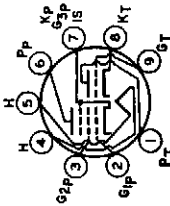

CLASS A₁ AMPLIFIER

Maximum Ratings, (Design-Maximum Values):

PLATE VOLTAGE.....	330 maz
GRID-NO.2 (SCREEN-GRID) SUPPLY VOLTAGE.....	330 maz
GRID-NO.2 VOLTAGE.....	See curve page 70
GRID-NO.1 (CONTROL-GRID) VOLTAGE, Positive-bias value.....	0 maz
PLATE DISSIPATION.....	2.5 maz
GRID-NO.2 INPUT: For grid-No.2 voltages up to 165 volts.....	0.55 maz
For grid-No.2 voltages between 165 and 330 volts.....	See curve page 70
PEAK HEATER-CATHODE VOLTAGE: Heater negative with respect to cathode.....	200 maz
Heater positive with respect to cathode.....	200 ^m maz
Characteristics:	
Plate Voltage.....	125 volts
Grid-No.2 Voltage.....	125 volts
Grid-No.1 Voltage.....	-1 volt
Amplification Factor.....	40
Plate Resistance (Approx.).....	5000 ohms
Transconductance.....	7000 μ mhos
Plate Current.....	12.5 ma
Grid-No.2 Current.....	4.5 ma
Grid-No.1 Voltage (Approx.) for plate current of 20 μ a.....	-7 volts
Maximum Circuit Values:	
Grid-No.1-Circuit Resistance.....	1 maz
The dc component must not exceed 100 volts.....	

SEMIREMOTE-CUTOFF
PENTODE

Miniature type used as if-amplifier tube in FM receivers employing series-connected heater strings. Outline 7B, OUTLINES SECTION. Tube requires miniature seven-contact socket and may be mounted in any position.

6HR6
Related type:
19HR6

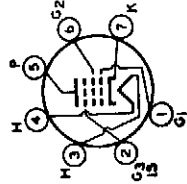

HEATER VOLTAGE (AC/DC).....	6.3 volts
HEATER CURRENT.....	0.45 ampere

HEATER WARM-UP TIME (AVERAGE).....	11	seconds
DIRECT INTERELECTRODE CAPACITANCES:		
Grid No.1 to Plate.....	0.006	max pf
Grid No.1 to Cathode, Heater, Grid No.2, Grid No.3, and Internal Shield.....	8.8	pf
Plate to Cathode, Heater, Grid No.2, Grid No.3, and Internal Shield.....	5.2	pf

CLASS A₁ AMPLIFIER

Maximum Ratings, (Design-Maximum Values):

PLATE SUPPLY VOLTAGE.....	300	max volts
GRID-NO.3 (SUPPRESSOR-GRID) VOLTAGE, Positive value.....	0	max volts
GRID-NO.2 (SCREEN-GRID) SUPPLY VOLTAGE.....	300	max volts
GRID-NO.2 VOLTAGE.....	See curve page 70	
GRID-NO.1 (CONTROL-GRID) VOLTAGE:		
Negative-bias value.....	-50	max volts
Positive-bias value.....	0	max volts
PLATE DISSIPATION.....	3	max watts
GRID-NO.2 INPUT:		
For grid-No.2 voltages up to 150 volts.....	1	max watt
For grid-No.2 voltages between 150 and 300 volts.....	See curve page 70	
PEAK HEATER-CATHODE VOLTAGE:		
Heater negative with respect to cathode.....	300	max volts
Heater positive with respect to cathode.....	200	max volts

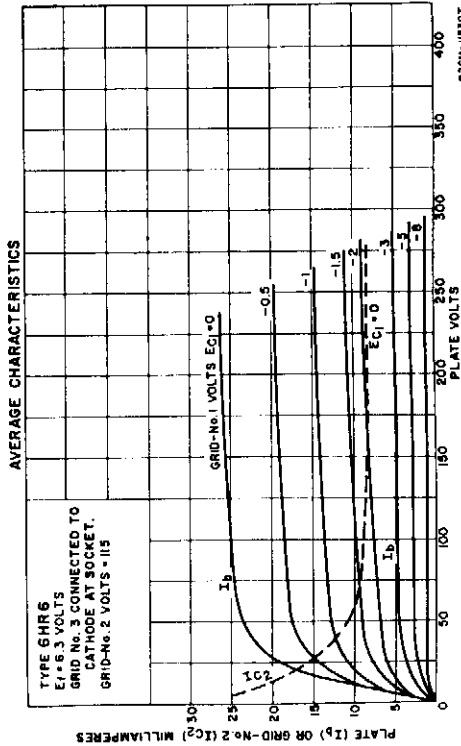

Characteristics:

Plate Supply Voltage.....	200	volts
Grid No.3.....	Connected to cathode at socket	
Grid-No.2 Supply Voltage.....	115	volts
Grid-No.1 Supply Voltage.....	0	volts
Cathode-Bias Resistor.....	68	ohms
Plate Resistance (Approx.).....	0.5	megohm
Transconductance.....	8500	μmhos
Grid-No.1 Voltage (Approx.) for transconductance of 60 μmhos.....	-15	volts
Plate Current.....	13.2	ma
Grid-No.2 Current.....	4.3	ma

Maximum Circuit Values:
 Grid-No.1-Circuit Resistance:
 For fixed-bias operation..... 0.5 max megohm
 For cathode-bias operation..... 1 max megohm
 ■ The dc component must not exceed 100 volts.

SHARP-CUTOFF PENTODE

Miniature type used as if-amplifier and limiter tube in FM receivers. Outline 7B, OUTLINES SECTION. Tube requires miniature seven-contact socket and may be mounted in any position.

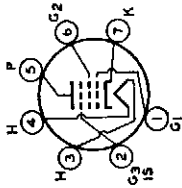

6HS6
 Related type:
 19HS6

HEATER VOLTAGE (AC/DC).....	6.3	volts
HEATER CURRENT.....	0.45	ampere
HEATER WARM-UP TIME (AVERAGE).....	11	seconds
DIRECT INTERELECTRODE CAPACITANCES:		
Grid No.1 to Plate.....	0.006	max pf
Grid No.1 to Cathode, Heater, Grid No.2, Grid No.3, and Internal Shield.....	8.8	pf
Plate to Cathode, Heater, Grid No.2, Grid No.3, and Internal Shield.....	5.2	pf

CLASS A₁ AMPLIFIER

Maximum Ratings, (Design-Maximum Values):

PLATE SUPPLY VOLTAGE.....	300	max volts
GRID-NO.3 (SUPPRESSOR-GRID) VOLTAGE, Positive Value.....	0	max volts
GRID-NO.2 (SCREEN-GRID) SUPPLY VOLTAGE.....	300	max volts
GRID-NO.2 VOLTAGE.....	See curve page 70	
GRID-NO.1 (CONTROL-GRID) VOLTAGE:		
Negative-bias value.....	-50	max volts
Positive-bias value.....	0	max volts
PLATE DISSIPATION.....	3	max watts
GRID-NO.2 INPUT:		
For grid-No.2 voltages up to 150 volts.....	1	max watt
For grid-No.2 voltages between 150 and 300 volts.....	See curve page 70	
PEAK HEATER-CATHODE VOLTAGE:		
Heater negative with respect to cathode.....	300	max volts
Heater positive with respect to cathode.....	200	max volts

Characteristics:

Plate Supply Voltage.....	75	150	volts
Grid No.3.....	Connected to cathode at socket		
Grid-No.2 Supply Voltage.....	75	75	volts
Grid-No.1 Supply Voltage.....	0	0	volts
Cathode-Bias Resistor.....	68	68	ohms
Amplification Factor*.....	50	-	
Plate Resistance (Approx.).....	-	0.5	megohm
Transconductance.....	-	9500	μmhos
Plate Current.....	-	8.8	ma
Grid-No.2 Current.....	-	2.8	ma
Grid-No.1 Voltage (Approx.) for plate current of 20 μa.....	-	-4	volts

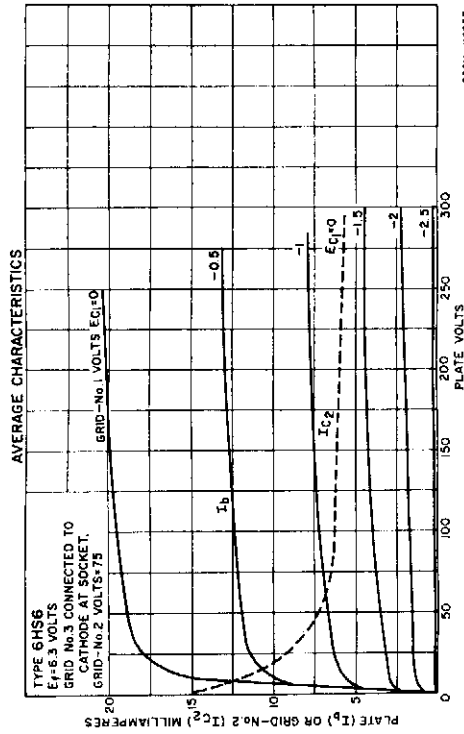

Maximum Circuit Values:

- Grid-No.1-Circuit Resistance: 0.5 maz megohm
- For fixed-bias operation: 1 maz megohm
- For cathode-bias operation: 1 maz megohm
- The dc component must not exceed 100 volts.
- Triode connection (grid No.2 connected to plate).

SHARP-CUTOFF TWIN PENTODE

Miniature type used in agc amplifier, sync, and noise-limiting circuits of television receivers. One pentode unit is used as combined sync separator and sync clipper; second pentode unit is used as agc amplifier. Outline 8D, OUTLINES SECTION. Tube requires miniature nine-contact socket and may be operated in any position.

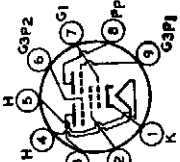

- HEATER VOLTS (AC/DC): 6.3 volts
- HEATER CURRENT: 0.3 ampere
- DIRECT INTERELECTRODE CAPACITANCES:
 - Grid No.3 to Plate (Each Unit): 2 pf
 - Grid No.1 to All Other Electrodes: 6 pf
 - Plate (Each Unit) to All Other Electrodes: 3.5 pf
 - Grid No.3 (Unit No.1) to Grid No.3 (Unit No.2): 0.015 maz

CLASS A1 AMPLIFIER

- Maximum Ratings, (Design-Maximum Values):
 - PLATE VOLTAGE (Each Unit): 300 maz
 - GRID-No.3 (SUPPRESSOR-GRID) VOLTAGE (Each Unit):
 - Peak positive value: 50 maz
 - DC negative value: -50 maz
 - DC positive value: 3 maz
 - GRID-No.2 (SCREEN-GRID) VOLTAGE: 150 maz
 - GRID-No.1 (CONTROL-GRID) VOLTAGE, Negative-bias value: -50 maz
 - CATHODE CURRENT: 12 maz
 - PLATE DISSIPATION (Each Unit): 1.1 maz
 - GRID-No.2 INPUT: 0.75 maz
 - PEAK HEATER-CATHODE VOLTAGE: 200 maz
 - Heater negative with respect to cathode: 200 maz
 - Heater positive with respect to cathode: 200 maz

Characteristics

- Plate Voltage: 100 volts
- Grid-No.3 Voltage: 0 volts

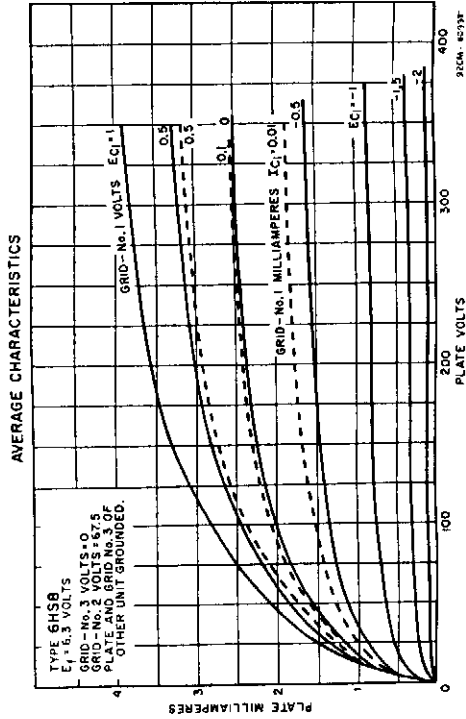

- Grid-No.2 Voltage: 67.5 volts
- Grid-No.1 Voltage: 0 volts
- Transconductance, Grid-No.3-to-Plate: 450 μ mhos
- Transconductance, Grid-No.1-to-Plate: 1100 μ mhos
- Plate Current: 2 ma
- Grid-No.3 Voltage (Approx.) for plate current of 100 μ a: -3.5 volts
- Grid-No.1 Voltage (Approx.) for plate current of 100 μ a: -2.3 volts

With Both Units Operating

- Plate Voltage (Each Unit): 100 volts
- Grid-No.3 Voltage (Each Unit): 0 volts
- Grid-No.2 Voltage: 67.5 volts
- Grid-No.1 Voltage: 0 volts
- Plate Current (Each Unit): 2 ma
- Grid-No.2 Current: 7 ma
- Cathode Current: 7.1 ma

Maximum Circuit Values:

- Grid-No.3-Circuit Resistance (Each Unit): 0.5 maz megohm
- Grid-No.1-Circuit Resistance: 0.5 maz megohm
- The dc component must not exceed 100 volts.
- With plate and grid No.3 of other unit connected to ground.
- Adjusted to give grid-No.1 current of 0.1 milliampere.

AVERAGE CHARACTERISTICS

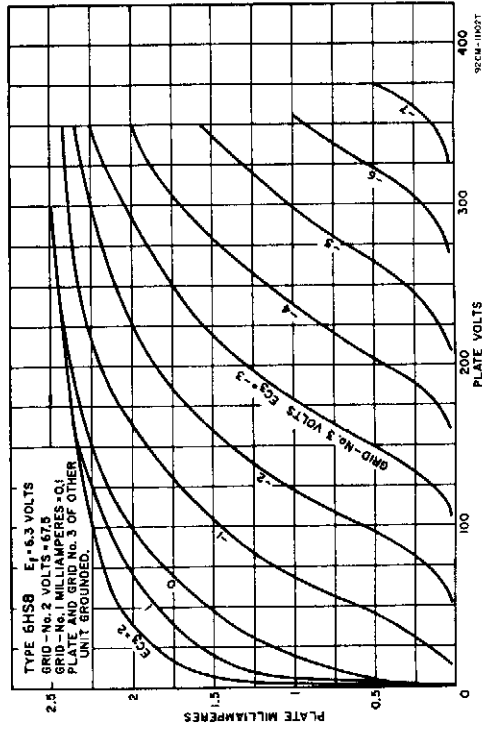

SHARP-CUTOFF PENTODE

Miniature type used as sound-receptor tube in FM and television receivers employing series-connected heater strings. Tube has two independent control grids. Outline 7B, OUTLINES SECTION. Tube requires miniature seven-contact socket and may be mounted in any position.

6HZ6

- HEATER VOLTAGE (AC/DC): 6.3 volts
- HEATER CURRENT: 0.45 ampere
- HEATER WARM-UP TIME (average): 11 seconds
- DIRECT INTERELECTRODE CAPACITANCES (Approx.):
 - Grid No.1 to Plate: 0.023 pf
 - Grid No.1 to Cathode, Heater, Grid No.2, Grid No.3, and Internal Shield: 8.2 pf
 - Grid No.1 to Grid No.3: 0.09 pf

Grid No.3 to Plate.....	1.6	pf
Grid No.3 to Cathode, Heater, Grid No.1, Grid No.2, Plate, and Internal Shield.....	7.2	pf
CLASS A₁ AMPLIFIER		
Characteristics:		
Plate Supply Voltage.....	150	volts
Grid-No.3 Supply Voltage.....	0	volts
Grid-No.2 Supply Voltage.....	100	volts
Grid-No.1 Supply Voltage.....	0	volts
Cathode-Bias Resistor.....	180	ohms
Plate Resistance (Approx.).....	0.11	megohm
Transconductance, Grid No.1 to Plate.....	3400	μmhos
Transconductance, Grid No.3 to Plate.....	600	μmhos
Plate Current.....	3.2	ma
Grid-No.2 Current.....	3.2	ma
Grid-No.3 Supply Voltage (Approx.) for plate current of 20 μa.....	-7	volts
Grid-No.1 Supply Voltage (Approx.) for plate current of 20 μa.....	-4.5	volts

FM SOUND DETECTOR

Maximum Ratings, (Design-Maximum Values):		
PLATE VOLTAGE.....	300	max
GRID-NO.3 (CONTROL-GRID) VOLTAGE:		
Negative value (dc and peak ac).....	-100	max
Positive value (dc and peak ac).....	25	max
300 max		
See curve page 70		
GRID-NO.2 VOLTAGE.....		
-50 max		
0 max		
1.7 max		
0.1 max		
watt		
GRID-NO.1 INPUT:		
1 max		
See curve page 70		
GRID-NO.2 INPUT:		
For grid-No.2 voltages up to 150 volts.....		
For grid-No.2 voltages between 160 and 300 volts.....		
PEAK HEATER-CATHODE VOLTAGE:		
Heater negative with respect to cathode.....	200	max
Heater positive with respect to cathode.....	200	max
Maximum Circuit Values:		
Grid-No.3-Circuit Resistance.....	0.68	max
Grid-No.1-Circuit Resistance:		
For fixed-bias operation.....	0.22	max
For cathode-bias operation.....	0.47	max
The dc component must not exceed 100 volts.		

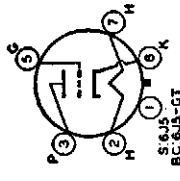
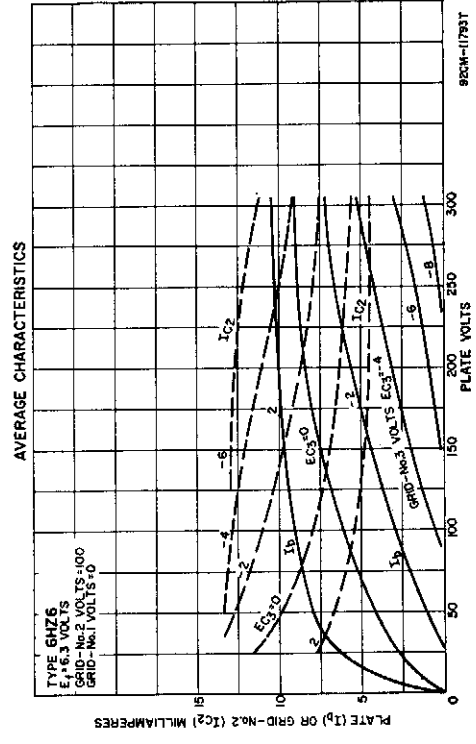
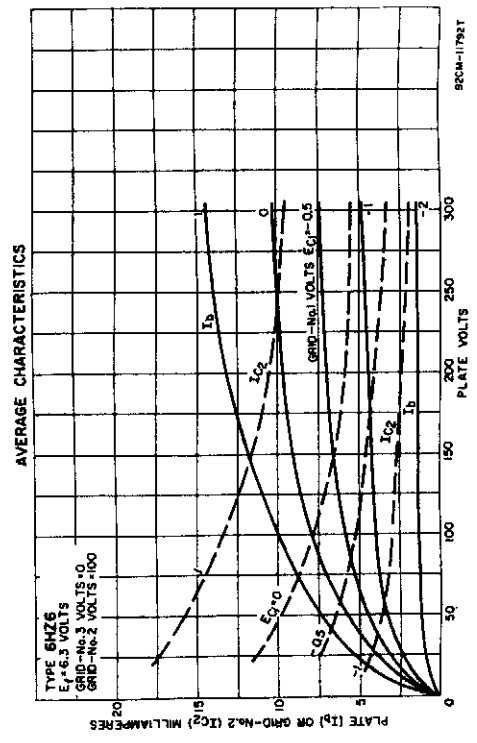

MEDIUM-MU TRIODE

Metal type 6J5 and glass octal type 6J5-GT used as detectors, amplifiers, or oscillators in radio equipment. These types feature high transconductance together with comparatively high amplification factor. Outlines 2 and 14C, respectively, OUTLINES SECTION. Tubes require octal socket and may be mounted in any position. For typical operation as resistance-coupled amplifiers, refer to RESISTANCE-COUPLED AMPLIFIER SECTION. Type 6J5-GT is used principally for renewal purposes.

HEATER VOLTAGE (AC/DC).....	6.3	volts
HEATER CURRENT.....	0.3	ampere
DIRECT INTER-ELECTRODE CAPACITANCES (Approx.):		
Grid to Plate.....	3.4	pf
Grid to Cathode and Heater.....	3.4	pf
Plate to Cathode and Heater.....	3.6	pf
* Shell connected to cathode. ** Base sleeve and external shield connected to cathode.		

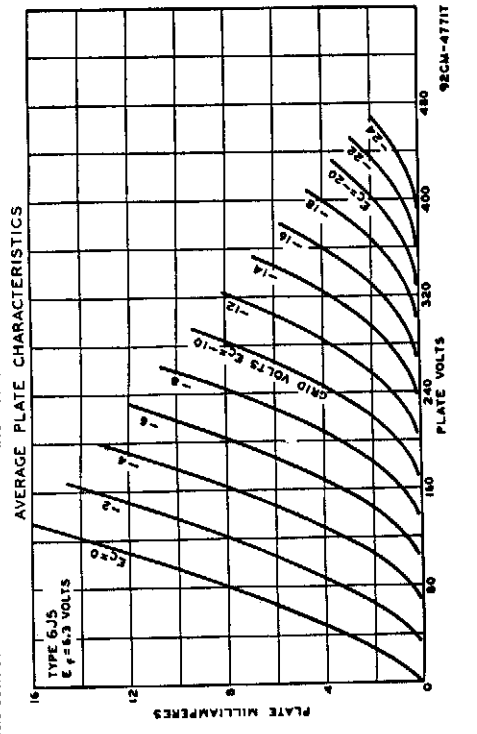

CLASS A₁ AMPLIFIER

Maximum Ratings, (Design-Center Values):

PLATE VOLTAGE	300 max	volts
GRID VOLTAGE, Positive-bias value	0 max	volts
PLATE DISSIPATION	2.5 max	watts
CATHODE CURRENT	20 max	ma
PEAK HEATER-CATHODE VOLTAGE:		
Heater negative with respect to cathode	90 max	volts
Heater positive with respect to cathode	90 max	volts

Characteristics:

Plate Voltage	90	volts
Grid Voltage	0	volts
Amplification Factor	20	
Plate Resistance (Approx.)	8700	ohms
Transconductance	3000	μmhos
Grid Voltage (Approx.) for plate current of 10 μA	-7	volts
Plate Current	10	ma

Maximum Circuit Value:
Grid-Circuit Resistance..... 1.0 max megohm

MEDIUM-MU TWIN TRIODE

Miniature types used as combined rf power amplifier and oscillator or as twin af amplifier. With push-pull arrangement of the grids and the plates in parallel, can also be used as a mixer

at frequencies as high as 600 megacycles per second. Outline 7B, OUTLINES SECTION. Tubes require miniature seven-contact socket and may be mounted in any position. Type 6J6 is a DISCONTINUED type listed for reference only.

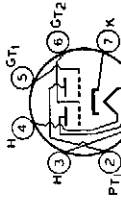

6J6
6J6A

Related types:
5J6, 19J6

HEATER VOLTAGE (AC/DC)..... 6.3 volts
HEATER CURRENT..... 0.45 ampere
HEATER WARM-UP TIME (Average) for 6J6-A..... 11 seconds

DIRECT INTERELECTRODE CAPACITANCES (Each Unit, Approx.):

Grid to Plate	1.6	pf
Grid to Cathode and Heater	2.2	pf
Plate to Cathode and Heater (Unit No.1)	0.4	pf
Plate to Cathode and Heater (Unit No.2)	1.1	pf

CLASS A₁ AMPLIFIER (Each Unit):

Maximum Ratings, (Design-Center Values):

PLATE VOLTAGE	300 max	volts
GRID VOLTAGE, Positive-bias value	0 max	volts
PLATE DISSIPATION	1.5 max	watts
PEAK HEATER-CATHODE VOLTAGE:		
Heater negative with respect to cathode	100 max	volts
Heater positive with respect to cathode	100 max	volts

Characteristics:

Plate Voltage	100	volts
Cathode-Bias Resistor	50†	ohms
Amplification Factor	38	
Plate Resistance (Approx.)	7100	ohms
Transconductance	6300	μmhos
Plate Current	8.5	ma

Maximum Circuit Values:

Grid-Circuit Resistance:
For fixed-bias operation..... Not recommended
For cathode-bias operation..... 0.5 max megohm

† Value is for both units operating at the specified conditions.

RF POWER AMPLIFIER AND OSCILLATOR—Class C Telephony

Key-down conditions per tube without modulation

Maximum Ratings, (Design-Center Values, Each Unit):

PLATE VOLTAGE	300 max	volts
GRID VOLTAGE	-40 max	volts
Negative-bias value	0 max	volts
Positive-bias value	0 max	volts

PLATE CURRENT	15 max	ma
GRID CURRENT	8 max	ma
PLATE INPUT	4.0 max	watts
PLATE DISSIPATION	1.5 max	watts
PEAK HEATER-CATHODE VOLTAGE:		
Heater negative with respect to cathode	100 max	volts
Heater positive with respect to cathode	100 max	volts

Typical Push-Pull Operation (Both Units):

Plate Voltage	150	volts
Grid Voltage	-10	volts
Plate Current	30	ma
Grid Current	16	ma
Driving Power (Approx.)	0.35	watt
Power Output (Approx.)	3.5	watts

* Obtained by grid resistor (625 ohms), cathode-bias resistor (220 ohms), or fixed supply.



SHARP-CUTOFF PENTODE

Metal type 6J7 and glass octal types 6J7-G and 6J7-GT are used as biased detectors or high-gain audio amplifiers in radio receivers. Outlines 3, 23, and 15A, respectively, OUTLINES SECTION. Type 6J7-GT is used principally for renewal purposes. Type 6J7-G is a DISCONTINUED type listed for reference only. All types require octal socket and may be mounted in any position. Heater volts (ac/dc), 6.3; amperes, 0.3.

6J7
6J7G
6J7GT

Related type:
12J7GT

CLASS A₁ AMPLIFIER

Maximum Ratings, (Design-Center Values):

PLATE VOLTAGE	300 max	volts
GRID-NO.2 (SCREEN-GRID) VOLTAGE	See curve page 70	volts
GRID-NO.2 SUPPLY VOLTAGE	300 max	volts
GRID-NO.1 (CONTROL-GRID) VOLTAGE, Positive-bias value	0 max	volts
PLATE DISSIPATION	0.75 max	watt
GRID-NO.2 INPUT:		
For grid-No.2 voltages up to 150 volts	0.10 max	watt
For grid-No.2 voltages between 150 and 300 volts	See curve page 70	volts

PEAK HEATER-CATHODE VOLTAGE:
Heater negative with respect to cathode..... 90 max volts
Heater positive with respect to cathode..... 90 max volts

Characteristics:

Plate Voltage	250	volts
Grid No.3	100	Connected to cathode at socket
Grid-No.2 Voltage	100	volts
Grid-No.1 Voltage	-3	volts
Plate Resistance (Approx.)	1	megohm
Transconductance	1185	μmhos
Grid-No.1 Voltage (Approx.) for plate current of 10 μA	-7	volts
Plate Current	2	ma
Grid-No.2 Current	0.5	ma

Maximum Circuit Value:

Grid-No.1-Circuit Resistance..... 1.0 max megohm

CLASS A₁ AMPLIFIER (Triode Connection)*

Maximum Ratings, (Design-Center Values):

PLATE VOLTAGE	250	volts
GRID-NO.1 VOLTAGE, Positive-bias value	0 max	volts
PLATE DISSIPATION (TOTAL)	1.75 max	watts
PEAK HEATER-CATHODE VOLTAGE:		
Heater negative with respect to cathode	90 max	volts
Heater positive with respect to cathode	90 max	volts

Characteristics:

Plate Voltage	180	volts
Grid-No.1 Voltage	-6.3	volts
Amplification Factor	20	
Plate Resistance (Approx.)	11000	ohms
Transconductance	1900	μmhos
Plate Current	5.8	ma

Maximum Circuit Value:

Grid-No.1-Circuit Resistance..... 1.0 max megohm

* Greater than 1.0 megohm.
* Grids No.2 and No.3 connected to plate.

TRIODE—HEPTODE CONVERTER

Glass octal type used as a combined triode oscillator and heptode mixer in radio receivers. Outline 23. **OUTLINES SECTION.** Tube requires octal socket. Heater volts (ac/dc), 6.3; amperes, 0.3. Typical operation—Heptode unit: plate volts, 250 (300 max); grids-No.2-and-No.4 volts, 100 max; grid-No.1 volts, -3; plate resistance, 1.5 megohms; conversion transconductance, 1.4; grids-No.2-and-No.4 ma., 2.8. Triode unit: plate volts, 250 max (applied through 20000-ohm dropping resistor); grid resistor, 50000 ohms; plate ma., 5.0. This is a DISCONTINUED type listed for reference only.

6J8G

PEAK POSITIVE-PULSE PLATE VOLTAGE#	6500 maz	volts
PEAK NEGATIVE-PULSE PLATE VOLTAGE	-1500 maz	volts
DC GRID-NO.3 VOLTAGE†	70 maz	volts
DC GRID-NO.2 VOLTAGE	220 maz	volts
DC GRID-NO.1 VOLTAGE	-55 maz	volts
PEAK NEGATIVE-PULSE GRID-NO.1 VOLTAGE	-330 maz	volts
PEAK CATHODE CURRENT	550 maz	ma
AVERAGE CATHODE CURRENT	175 maz	ma
PLATE DISSIPATION*	17.5 maz	watts
GRID-NO.2 INPUT	3.5 maz	watts
PEAK HEATER-CATHODE VOLTAGE	200 maz	volts
Heater negative with respect to cathode	200 maz	volts
Heater positive with respect to cathode	240 maz	volts
BULB TEMPERATURE (At hottest point)		°C

BEAM POWER TUBE

Novar type used as high-efficiency horizontal-deflection-amplifier tube in television receivers. Outline 18A, **OUTLINES SECTION.** Tube requires novar nine-contact socket and may be mounted in any position.

6JB6

Related types:
12JB6, 17JB6

HEATER VOLTAGE (AC/DC)	6.3	volts
HEATER CURRENT	1.2	amperes
DIRECT INTERELECTRODE CAPACITANCES (Approx.):		
Grid No.1 to Plate	0.2	pf
Grid No.1 to Cathode, Heater, Grid No.2, and Grid No.3	15	pf
Plate to Cathode, Heater, Grid No.2, and Grid No.3	6	pf

CLASS A₁ AMPLIFIER

Characteristics:		
Plate Voltage	Triode Connection	Pentode Connection
Grid No.3 (Suppressor Grid)	150	60
Grid No.2 (Screen-Grid) Voltage	150	130
Grid No.1 (Control-Grid) Voltage	150	150
Mu-Factor, Grid No.2 to Grid No.1	-22.3	0 -22.3
Plate Resistance (Approx.)	4.4	—
Transconductance	—	—
Plate Current	—	—
Grid-No.2 Current	—	—
Grid-No.1 Voltage for plate current of 1 ma.	—	—

HORIZONTAL-DEFLECTION AMPLIFIER

For operation in a 525-line, 30-frame system

Maximum Ratings, (Design-Maximum Values):		
DC PLATE SUPPLY VOLTAGE	770 maz	volts

AVERAGE CHARACTERISTICS

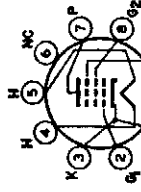
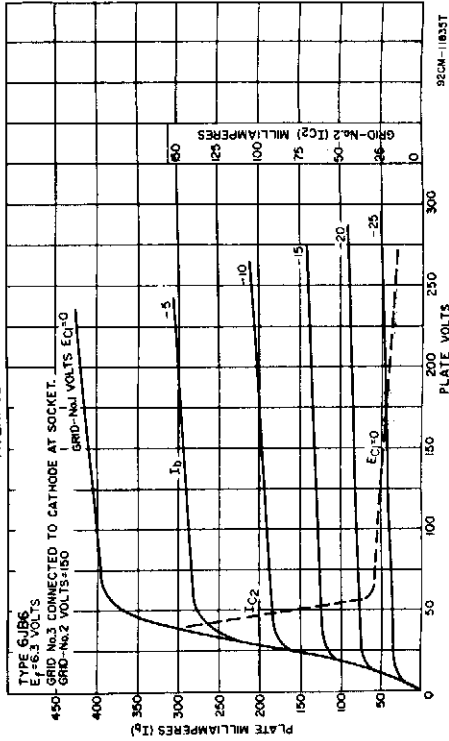

SHARP-CUTOFF PENTODE

Miniature type with frame grid used in if-amplifier stages of television receivers utilizing intermediate frequencies in the order of 40 megacycles. Tube features high transconductance at low B-supply voltages. Outline 8B, **OUTLINES SECTION.** Tube requires miniature nine-contact socket and may be mounted in any position.

6JC6

Related types:
3JC6, 4JC6

HEATER VOLTAGE (AC/DC)	6.3	volts
HEATER CURRENT	0.3	ampere
DIRECT INTERELECTRODE CAPACITANCES:		
Grid No.1 to Plate	0.019 maz	pf
Grid No.1 to Cathode, Heater, Grid No.2, Grid No.3, and Internal Shield	8.2	pf
Plate to Cathode, Heater, Grid No.2, Grid No.3, and Internal Shield	3	pf

CLASS A₁ AMPLIFIER

Maximum Ratings, (Design-Maximum Values):

PLATE VOLTAGE	380 maz	volts
GRID-NO.3 (SUPPRESSOR-GRID) VOLTAGE, Positive value	0 maz	volts
GRID-NO.2 (SCREEN-GRID) SUPPLY VOLTAGE	330 maz	volts
GRID-NO.2 VOLTAGE	See curve page 70	volts
GRID-NO.1 (CONTROL-GRID) VOLTAGE, Positive-bias value	0 maz	volts
GRID-NO.2 INPUT		
For grid-No.2 voltages up to 165 volts	0.6 maz	watt
For grid-No.2 voltages between 165 and 380 volts	See curve page 70	watts
PLATE DISSIPATION	2.5 maz	watts
PEAK HEATER-CATHODE VOLTAGE	200 maz	volts
Heater negative with respect to cathode	200 maz	volts
Heater positive with respect to cathode	200 maz	volts

Characteristics:

Plate Supply Voltage	125	volts
Grid No.3	Connected to cathode at socket	volts
Grid-No.2 Supply Voltage	125	volts
Cathode-Bias Resistor	56	ohms
Plate Resistance (Approx.)	0.18	megohm
Transconductance	15000	ambos
Plate Current	13	ma
Grid-No.2 Current	3.2	ma
Grid-No.1 Voltage (Approx.) (for plate current of 100 μ a)	-3	volts

Maximum Circuit Values:

- Grid-No. 1-Circuit Resistance: 0.25 maz megohm
- For fixed-bias operation: 1 maz megohm
- For cathode-bias operation: 1 maz megohm
- The dc component must not exceed 100 volts.

AVERAGE CHARACTERISTICS

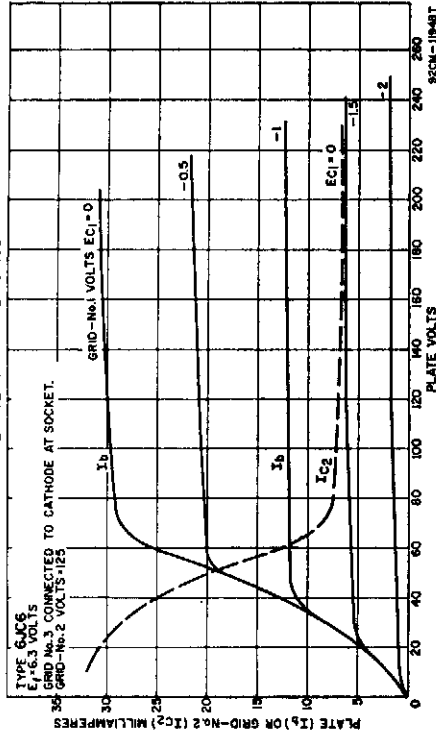

MEDIUM-MU TRIODE—SHARP-CUTOFF PENTODE

Miniature type used as combined vhf oscillator and mixer tube in television receivers employing series-connected heater strings. Outline 8B, OUTLINES SECTION. Tube requires miniature nine-contact socket and may be mounted in any position. Heater volts (ac/dc), 6.3; amperes, 0.45; warm-up time (average), 11 seconds.

6JC8

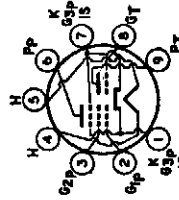

CLASS A₁ AMPLIFIER

Maximum Ratings, (Design-Maximum Values):	Triode Unit	Pentode Unit
PLATE VOLTAGE	275 maz	275 maz
GRID-NO. 2 (SCREEN-GRID) SUPPLY VOLTAGE	0 maz	0 maz
GRID-NO. 2 VOLTAGE	1.7 maz	2.8 maz
GRID-NO. 1 (CONTROL-GRID) VOLTAGE, Positive-bias value	0 maz	0 maz
PLATE DISSIPATION	200 maz	200 maz
GRID-NO. 2 INPUT	0.45 maz	0.45 maz
For grid-No. 2 voltages up to 187.5 volts	See curve page 70	See curve page 70
For grid-No. 2 voltages between 137.5 and 275 volts	200 maz	200 maz
PEAK HEATER-CATHODE VOLTAGE	200 maz	200 maz
Heater negative with respect to cathode		
Heater positive with respect to cathode		

Characteristics:

Plate Voltage	100	125	volts
Grid-No. 1 Voltage	0	0	volts
Grid-No. 2 Voltage	-1	-1	volt
Amplification Factor	40	40	
Plate Resistance (Approx.)	6000	5700	ohms
Transconductance	6500	5600	μmhos
Plate Current	12	9	ma
Grid-No. 2 Current	—	2.2	ma
Grid-No. 1 Voltage (Approx.) for plate current of 20 μa	-7	-6.5	volts

Maximum Circuit Values:

- Grid-No. 1-Circuit Resistance: 0.1 maz megohm
- For fixed-bias operation: 0.5 maz megohm
- For cathode-bias operation: 0.5 maz megohm
- The dc component must not exceed 100 volts.

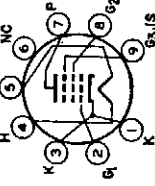

SHARP-CUTOFF PENTODE

Miniature type used as if-amplifier tube in television receivers utilizing an intermediate frequency in the order of 40 megacycles. Outline 8B, OUTLINES SECTION. Tube requires miniature nine-contact socket and may be mounted in any position.

6JD6
Related types:
3JD6, 4JD6

- HEATER VOLTAGE (AC/DC): 6.3 volts
- HEATER CURRENT: 0.3 ampere
- DIRECT INTERELECTRODE CAPACITANCES:
 - Grid No. 1 to Plate: 0.019 maz pf
 - Grid No. 1 to Cathode, Heater, Grid No. 2, Grid No. 3, and Internal Shield: 8.2 pf
 - Plate to Cathode, Heater, Grid No. 2, Grid No. 3, and Internal Shield: 3 pf

CLASS A₁ AMPLIFIER

Maximum Ratings, (Design-Maximum Values):

- PLATE VOLTAGE: 330 maz volts
- GRID-NO. 3 (SUPPRESSOR-GRID) VOLTAGE, Positive value: 0 maz volts
- GRID-NO. 2 (SCREEN-GRID) SUPPLY VOLTAGE: 330 maz volts
- GRID-NO. 2 VOLTAGE: 0 maz volts
- GRID-NO. 1 (CONTROL-GRID) VOLTAGE, Positive-bias value: See curve page 70
- GRID-NO. 2 INPUT: 0 maz watts
- For grid-No. 2 voltages up to 165 volts: See curve page 70
- For grid-No. 2 voltages between 165 and 330 volts: 2.5 maz watts
- PEAK HEATER-CATHODE VOLTAGE: 200 maz volts
- Heater negative with respect to cathode: 200 maz volts
- Heater positive with respect to cathode: 200 maz volts

Characteristics:

- Plate Supply Voltage: 125 volts
- Grid-No. 3 Voltage: 0 volts
- Grid-No. 2 Supply Voltage: 125 volts
- Grid-No. 1 Supply Voltage: 0 volts
- Cathode-Bias Resistor: 56 ohms
- Plate Resistance (Approx.): 160000 ohms
- Transconductance: 14000 μmhos
- Plate Current: 15 ma
- Grid-No. 2 Current: 4 ma
- Grid-No. 1 Voltage (Approx.) for transconductance of 600 μmhos: -4.5 volts

Maximum Circuit Values:

- Grid-No. 1-Circuit Resistance: 0.25 maz megohm
- For fixed-bias operation: 1 maz megohm
- For cathode-bias operation: 1 maz megohm
- The dc component must not exceed 100 volts.

AVERAGE CHARACTERISTICS

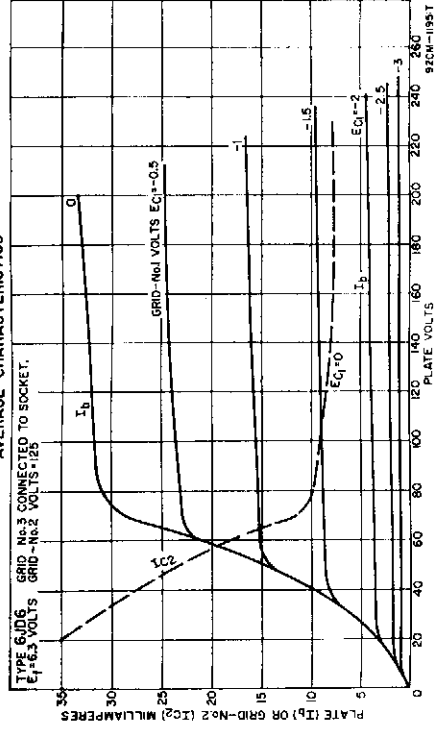

BEAM POWER TUBE

Novar type used as horizontal-deflection-amplifier tube in color television receivers. Outline 18B, OUTLINES SECTION. Tube requires novar nine-contact socket and may be mounted in any position.

6JE6

HEATER VOLTAGE (AC/DC).....	6.3	volts
HEATER CURRENT.....	2.5	amperes
DIRECT INTERELECTRODE CAPACITANCES (Approx.):		
Grid No.1 to Plate.....	0.44	pf
Grid No.1 to Cathode, Heater, Grid No.2, and Grid No.3.....	21	pf
Plate to Cathode, Heater, Grid No.2, and Grid No.3.....	11	pf

CLASS A₁ AMPLIFIER

Characteristics:		
Plate Voltage.....	125	volts
Grid No.3 (Suppressor Grid).....	70	volts
Grid No.2 (Screen-Grid) Voltage.....	125	volts
Grid No.1 (Control-Grid) Voltage.....	-25	volts
Amplification Factor.....	3.3	
Plate Resistance (Approx.).....	5500	ohms
Transconductance.....	10600	μmhos
Plate Current.....	680†	ma
Grid-No.2 Current.....	40†	ma
Grid-No.1 Voltage (Approx.) for plate current of 1 ma.....	-55	volts

HORIZONTAL-DEFLECTION AMPLIFIER

For operation in a 525-line, 30-frame system

Maximum Ratings, (Design-Maximum Values):		
DC PLATE SUPPLY VOLTAGE.....	990	max
PEAK POSITIVE-PULSE PLATE VOLTAGE*.....	7000	max
PEAK NEGATIVE-PULSE PLATE VOLTAGE.....	-1100	max
DC GRID-NO.3 VOLTAGE*.....	75	max
DC GRID-NO.2 VOLTAGE.....	190	max
PEAK NEGATIVE-PULSE GRID-NO.1 VOLTAGE.....	-250	max
PEAK CATHODE CURRENT.....	1100	max
AVERAGE CATHODE CURRENT.....	315	max
GRID-NO.2 INPUT.....	3.2	max
PLATE DISSIPATION [†]	24	max
PEAK HEATER-CATHODE VOLTAGE:		
Heater negative with respect to cathode.....	200	max
Heater positive with respect to cathode.....	2400	max
BULB TEMPERATURE (At hottest point).....	240	max

AVERAGE CHARACTERISTICS

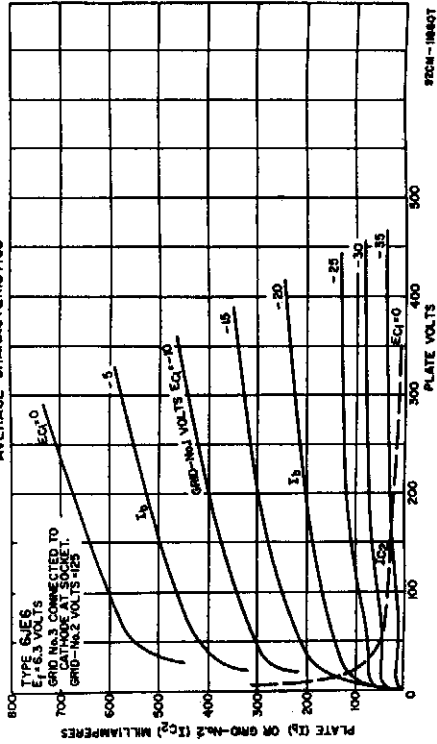

Maximum Circuit Values:

- Grid-No.1-Circuit Resistance: 0.47 max megohm
- For grid-resistor-bias operation[†]..... 10 max megohms
- For plate-pulsed operation (horizontal-deflection circuits only).....
- † This value can be measured by a method involving a recurrent waveform such that the maximum ratings of the tube will not be exceeded.
- ‡ The duration of the voltage pulse must not exceed 15 per cent of one horizontal scanning cycle. In a 525-line, 30-frame system, 15 per cent of one horizontal scanning cycle is 10 microseconds.
- In this service, a positive voltage may be applied to grid No.3 to minimize "snivets" interference; a typical value for this voltage is 30 volts.
- ‡ An adequate bias resistor or other means is required to protect the tube in the absence of excitation.
- * The dc component must not exceed 100 volts.

AVERAGE CHARACTERISTICS

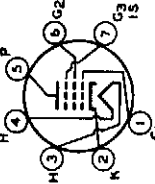
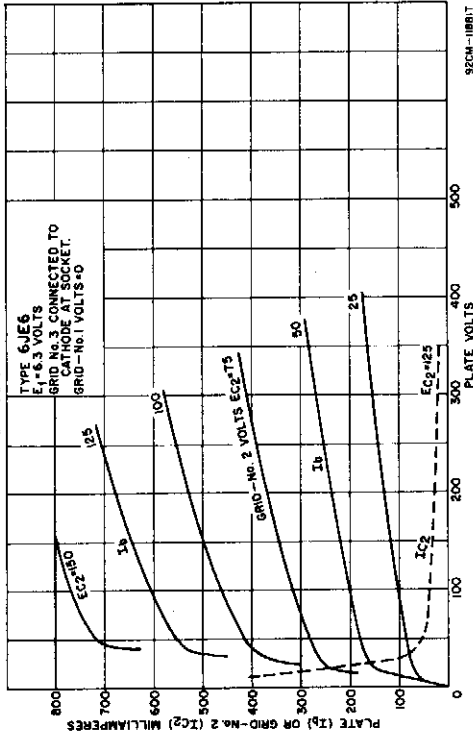

SEMIREMOTE-CUTOFF PENTODE

Miniature type used in the gain-controlled picture if-amplifier stages of television receivers. Outline 7B, OUTLINES SECTION. Tube requires miniature seven-contact socket and may be mounted in any position. For curves of average plate characteristics, refer to type 6BZ6.

6JH6

HEATER VOLTAGE (AC/DC).....	6.3	volts
HEATER CURRENT.....	0.3	ampere
DIRECT INTERELECTRODE CAPACITANCES:		
Grid No.1 to Plate.....	Without External Shield	7
Grid No.1 to Cathode, Heater, Grid No.2, Grid No.3, and Internal Shield.....	With External Shield	0.025 max
Plate to Cathode, Heater, Grid No.2, Grid No.3, and Internal Shield.....	Without External Shield	7
	With External Shield	0.015 max
		3

CLASS A₁ AMPLIFIER

Maximum Ratings, (Design-Maximum Values):

PLATE VOLTAGE.....	300	max
GRID-NO.3 (SUPPRESSOR-GRID) VOLTAGE, Positive value.....	0	max
GRID-NO.2 (SCREEN-GRID) SUPPLY VOLTAGE.....	300	max
GRID-NO.2 VOLTAGE.....	See curve pages, 70	
GRID-NO.1 (CONTROL-GRID) VOLTAGE, Positive-bias value.....	0	max
GRID-NO.2 INPUT.....	0.55	max
For grid-No.2 voltages up to 150 volts.....	See curve page 70	
For grid-No.2 voltages between 150 and 300 volts.....	See curve page 70	

PEAK HEATER-CATHODE VOLTAGE:
 Heater negative with respect to cathode..... 200 maz
 Heater positive with respect to cathode..... 200^mmaz

Characteristics:
 Plate Supply Voltage..... 125 volt
 Grid No. 3..... Connected to cathode at socket
 Grid-No. 2 Supply Voltage..... 125 volts
 Cathode-Bias Resistor..... 56 ohms
 Plate Resistance (Approx.)..... 8000 megohm
 Transconductance..... 400-900 μ mhos
 Transconductance Range for grid-No. 1 voltage of -4.5 volts and cathode-bias resistor of 56 ohms
 Grid-No. 1 Voltage (Approx.) for transconductance of 50 μ mhos and no cathode-bias resistor..... -19 volts
 Plate Current..... 14 ma
 Grid-No. 2 Current..... 3.6 ma

Maximum Circuit Values:
 Grid-No. 1-Circuit Resistance:
 For fixed-bias operation..... 0.25 maz
 For cathode-bias operation..... 1 maz
 With external shield connected to cathode.
 The dc component must not exceed 100 volts.

BEAM-DEFLECTION TUBE

Miniature type used in color-deflector and burst-gate circuits in color television receivers. This type has two plates and two deflecting electrodes; the control grid varies beam deflection. Outline 8D, OUTLINES SECTION. Tube requires miniature nine-contact socket and may be mounted in any position. Pin 5 should be connected to cathode at socket. The 6JH8 should be so located in the equipment that it is not subjected to stray magnetic fields. Heater volts (ac/dc), 6.3; amperes, 0.3.

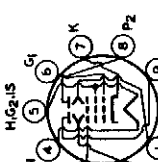

6JH8

COLOR TV DEMODULATOR

Maximum Ratings, (Design Maximum Values):
 PLATE VOLTAGE (EACH PLATE)..... 330 maz
 PEAK DEFLECTING-ELECTRODE VOLTAGE (EACH ELECTRODE):
 Negative value..... -165 maz
 Positive value..... 165 maz
 GRID-NO. 3 (ACCELERATING-GRID) VOLTAGE..... 330 maz
 GRID-NO. 1 (CONTROL-GRID) VOLTAGE, Positive-bias value..... 0 maz
 CATHODE CURRENT..... 33 maz
 PLATE DISSIPATION (EACH PLATE)..... 8 maz
 GRID-NO. 3 INPUT..... 1 maz

Maximum Circuit Values:
 Grid-No. 1 Circuit Resistance:
 For fixed-bias operation..... 0.1 maz
 For cathode-bias operation..... 0.25 maz

CLASS A₁ AMPLIFIER
 With both plates connected together and with both deflecting electrodes connected to cathode at socket

Characteristics:
 Plate-No. 1 Supply Voltage..... 250 volts
 Plate-No. 2 Supply Voltage..... 250 volts
 Grid-No. 3 Voltage..... 250 volts
 Cathode-Bias Resistor..... 4400 ohms
 Transconductance..... 14 μ mhos
 Total Plate Current..... 1.5 ma
 Grid-No. 3 Current..... 1.5 ma
 Grid-No. 1 Voltage (Approx.) for total plate current of 10 μ a..... -13 volts

HIGH-MU TRIODE—SHARP-CUTOFF PENTODE

Miniature type with frame-grid pentode unit used in television receivers. The triode unit is used as a voltage-amplifier or sync-separator tube, and the pentode unit is used as a video-amplifier tube. Outline 11A, OUTLINES SECTION, except base is small-button miniature 9-pin. Tube requires miniature nine-contact socket and may be mounted in any position. Heater volts (ac/dc), 6.3; amperes, 0.725.

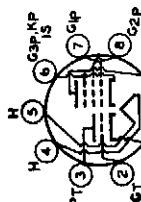

6JT8

CLASS A₁ AMPLIFIER

Maximum Ratings, (Design-Maximum Values):

PLATE VOLTAGE..... 330 maz
 GRID-NO. 2 (SCREEN-GRID) SUPPLY VOLTAGE..... 330 maz
 GRID-NO. 2 VOLTAGE..... 330 maz
 GRID-NO. 1 (CONTROL-GRID) VOLTAGE, Positive-bias value..... 0 maz
 PLATE DISSIPATION..... 4 maz
 GRID-NO. 2 INPUT:
 For grid-No. 2 voltages up to 165 volts..... 1.1 maz
 For grid-No. 2 voltages between 165 and 330 volts..... See curve page 70
PEAK HEATER-CATHODE VOLTAGE:
 Heater negative with respect to cathode..... 200 maz
 Heater positive with respect to cathode..... 200^mmaz

Characteristics:

Plate Supply Voltage..... 250 volts
 Grid-No. 2 Supply Voltage..... 100 volts
 Grid-No. 1 Voltage..... -2 volts
 Cathode-Bias Resistor..... 100 ohms
 Amplification Factor..... 37000
 Plate Resistance (Approx.)..... 2700 ohms
 Transconductance..... 1.5 μ mhos
 Plate Current..... 17 ma
 Grid-No. 2 Current..... 17 ma
 Grid-No. 1 Voltage (Approx.) for plate current of 100 μ a..... -5.3 volts
 Grid-No. 1 Voltage (Approx.) for plate current of 20 μ a..... -5.3 volts

Maximum Circuit Values:

Grid-No. 1-Circuit Resistance:
 For fixed-bias operation..... 0.5 maz
 For cathode-bias operation..... 1 maz
 The dc component must not exceed 100 volts.
 This value can be measured by a method involving a recurrent waveform such that the maximum ratings of the tube will not be exceeded.

QUADRUPLE DIODE

Miniature type used in phase-detector and noise-immune, color-killer circuits of color television receivers; also used in bridge-matrixing circuits in FM stereo multiplex equipment. Outline 8D, OUTLINES SECTION. Units 1 and 2 are shielded from units 3 and 4 to minimize coupling between the series-connected pairs of diodes. Tube requires miniature nine-contact socket and may be mounted in any position.



6JU8

Maximum Ratings, (Design-Maximum Values):
 PLATE VOLTAGE..... 330 maz
 GRID-NO. 2 (SCREEN-GRID) SUPPLY VOLTAGE..... 330 maz
 GRID-NO. 2 VOLTAGE..... 330 maz
 GRID-NO. 1 (CONTROL-GRID) VOLTAGE, Positive-bias value..... 0 maz
 PLATE DISSIPATION..... 4 maz
 GRID-NO. 2 INPUT:
 For grid-No. 2 voltages up to 165 volts..... 1.1 maz
 For grid-No. 2 voltages between 165 and 330 volts..... See curve page 70
PEAK HEATER-CATHODE VOLTAGE:
 Heater negative with respect to cathode..... 200 maz
 Heater positive with respect to cathode..... 200^mmaz

Characteristics:
 Plate Supply Voltage..... 250 volts
 Grid-No. 2 Supply Voltage..... 250 volts
 Grid-No. 1 Voltage..... -2 volts
 Cathode-Bias Resistor..... 100 ohms
 Amplification Factor..... 37000
 Plate Resistance (Approx.)..... 2700 ohms
 Transconductance..... 1.5 μ mhos
 Plate Current..... 17 ma
 Grid-No. 2 Current..... 17 ma
 Grid-No. 1 Voltage (Approx.) for plate current of 100 μ a..... -5.3 volts
 Grid-No. 1 Voltage (Approx.) for plate current of 20 μ a..... -5.3 volts

Plate of Unit No.3 and Cathode of Unit No.4 to Cathode of Unit No.3
 Plate of Unit No.3 and Cathode of Unit No.4 to Plate of Unit No.4
 Plate of Unit No.4 to Heater and Internal Shield
 Cathode of Unit No.1 to Heater and Internal Shield
 Cathode of Unit No.3 to Heater and Internal Shield

Maximum Ratings, (Design-Maximum Values, Each Unit):

PEAK INVERSE PLATE VOLTAGE..... 300 max volts
 PEAK PLATE CURRENT..... 5A max ma
 DC OUTPUT CURRENT..... 9 max ma
 PEAK HEATER-CATHODE VOLTAGE:
 Heater negative with respect to cathode..... 300 max volts
 Heater positive with respect to cathode..... 300 max volts

Characteristics, Instantaneous Value, (Each Unit):

Plate Current for plate voltage of 10 volts..... 50 ma

**HIGH-MU TRIODE—
SHARP-CUTOFF PENTODE**

Miniature type used in a wide variety of applications in television receivers, particularly those having low-voltage "B" supplies and employing series-connected heater strings. The

6JV8

Related type:
6JVs

triode unit is used in sound-if, keyed-agc, sync-separator, sync-amplifier, and noise-suppression circuits. The pentode unit is especially useful as a video amplifier tube. Outline 8D, OUTLINES SECTION. Tube requires miniature nine-contact socket and may be mounted in any position.

HEATER VOLTAGE (AC/DC)..... 6.3 volts
 HEATER CURRENT..... 0.6 ampere
 HEATER WARM-UP TIME (AVERAGE)..... 11 seconds

DIRECT INTERELECTRODE CAPACITANCES (APPROX.):

Triode Unit:
 Grid to Plate..... 2.2 pf
 Grid to Cathode and Heater..... 3 pf
 Plate to Cathode and Heater..... 2 pf

Pentode Unit:

Grid No.1 to Plate..... 0.08 maz
 Grid No.1 to Cathode, Heater, Grid No.2, Grid No.3, and Internal Shield..... 8 pf
 Plate to Cathode, Heater, Grid No.2, Grid No.3, and Internal Shield..... 3.2 pf
 Pentode Grid No.1 to Triode Plate..... 0.012 maz
 Pentode Plate to Triode Plate..... 0.24 maz

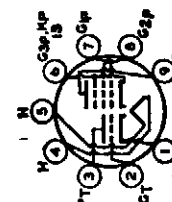

AVERAGE PLATE CHARACTERISTICS
TRIODE UNIT

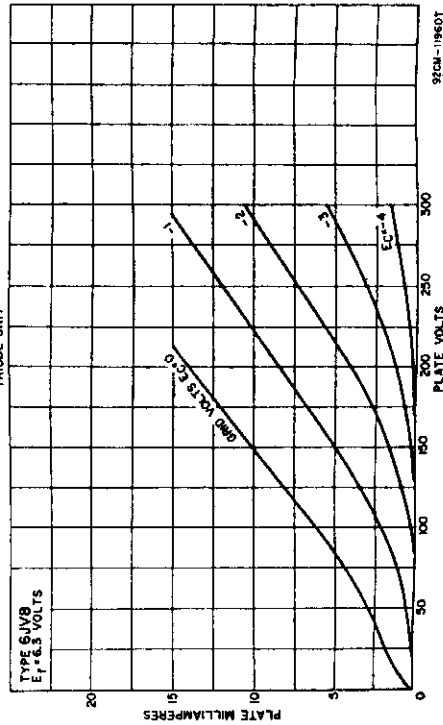

CLASS A1 AMPLIFIER

Maximum Ratings, (Design-Maximum Values):

PLATE VOLTAGE..... Triode Unit 350 maz
 Pentode Unit 380 maz
 Grid-No.1 (SCREEN-GRID) VOLTAGE:
 Positive-bias value..... 0 maz
 Negative-bias value..... -50 maz
 Grid-No.2 (CONTROL-GRID) VOLTAGE:
 Positive-bias value..... 1.1 maz
 Negative-bias value..... -

Characteristics:

Plate Voltage..... Triode Unit 200
 Pentode Unit 200
 Grid-No.1 Voltage..... -2
 Grid-No.2 Voltage..... 70
 Amplification Factor..... 0.0175
 Plate Resistance (Approx.)..... 4000
 Transconductance..... 51
 Plate Current..... 14
 Grid-No.2 Current..... 4
 Grid-No.1 Voltage (Approx.) for plate current of 20 ma..... -5
 Maximum Circuit Values:
 Grid-No.1-Current Resistance:
 For fixed-bias operation..... 0.5 maz
 For cathode-bias operation..... 1 maz

The dc component must not exceed 100 volts.
 This value can be measured by a method involving a recurrent waveform such that the maximum ratings of the tube will not be exceeded.

AVERAGE CHARACTERISTICS
PENTODE UNIT

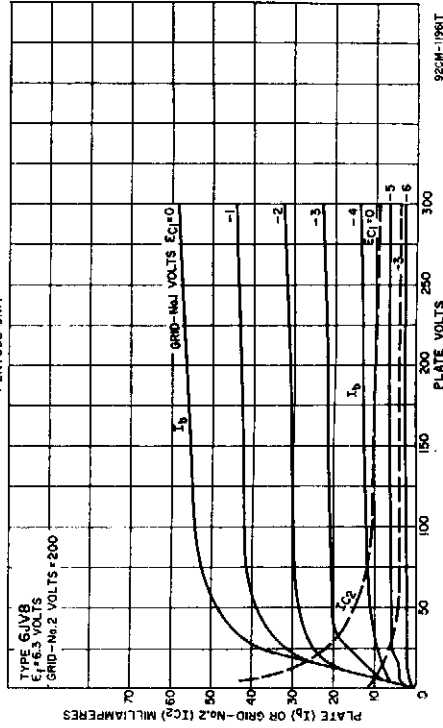

HIGH-MU TRIODE

Glass octal type used as voltage amplifier in radio equipment. Outline 15A, OUTLINES SECTION. Tube requires octal socket. Heater volts (ac/dc), 6.3; amperes, 0.3. Characteristics as class A1 amplifier: plate volts, 250 maz; grid volts, -3; amplification factor, 70; plate resistance, 50000 ohms; transconductance, 1400 umhos; plate ma., 1.1. This is a DISCONTINUED type listed for reference only.

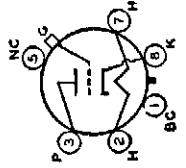

6K5GT

POWER PENTODE

Glass octal type used in output stage of radio receivers and, triode-connected, as a vertical deflection amplifier in television receivers. It is capable of delivering moderate power output with relatively small input voltage. Tube may be used singly or in push-pull. This type may be supplied with pin No.1 omitted. Tube requires octal socket and may be mounted in any position. Outline 14C, OUTLINES SECTION. It is especially important that this tube, like other power-handling tubes, be adequately ventilated.

6K6GT

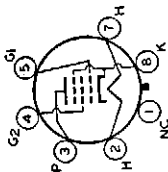

HEATER VOLTAGE (ac/dc)	6.3 volts
HEATER CURRENT	0.4 ampere
DRIFT INTERELECTRODE CAPACITANCES (Approx.):	
Grid No.1 to Plate	0.5 pf
Grid No.1 to Cathode, Heater, Grid No.2, and Grid No.3	5.5 pf
Plate to Cathode, Heater, Grid No.2, and Grid No.3	6.0 pf

CLASS A₁ AMPLIFIER

Maximum Ratings, (Design-Center Values):

PLATE VOLTAGE	315 max
GRID-NO.2 (SCREEN-GRID) VOLTAGE	285 max
PLATE DISSIPATION	8.5 max
GRID-NO.2 INPUT	2.8 max
PEAK HEATER-CATHODE VOLTAGE:	
Heater negative with respect to cathode	200 max
Heater positive with respect to cathode	200* max

Typical Operation:

Plate Voltage	250
Grid-No.2 Voltage	250
Grid-No.1 (Control-Grid) Voltage	-18
Peak AF Grid-No.1 Voltage	18
Zero-Signal Plate Current	32
Maximum-Signal Plate Current	39
Zero-Signal Grid-No.2 Current	6.5
Zero-Signal Grid-No.2 Current	1.6
Maximum-Signal Grid-No.2 Current	10.000
Plate Resistance (Approx.)	90000
Transconductance	2300
Load Resistance	7600
Total Harmonic Distortion	11
Maximum-Signal Power Output	3.4

Typical Push-Pull Operation (Values are for two tubes):

Plate Supply Voltage	280
Grid-No.2 Supply Voltage	285
Grid-No.1 Voltage	285
Cathode-Bias Resistor	-25.5
Peak AF Grid-No.1-to-Grid-No.1 Voltage	51
Zero-Signal Plate Current	55
Maximum-Signal Plate Current	72
Zero-Signal Grid-No.2 Current	9
Maximum-Signal Grid-No.2 Current	17
Effective Load Resistance (Plate-to-plate)	12000
Total Harmonic Distortion	6
Maximum-Signal Power Output	10.5

Maximum Circuit Values:

Grid-No.1-Circuit Resistance:	
For fixed-bias operation	0.1 max
For cathode-bias operation	0.5 max

Characteristics (Triode Connection)*:

Plate Voltage	250
Grid-No.1 Voltage	-18
Plate Current	37.5
Transconductance	2700
Amplification Factor	6.8
Plate Resistance (Approx.)	2500
Grid-No.1 Voltage (Approx.) for plate current of 0.5 ma.	-43

VERTICAL DEFLECTION AMPLIFIER (Triode Connection)**

Maximum Ratings:	
DC PLATE VOLTAGE	315 max
PEAK POSITIVE-PULSE PLATE VOLTAGE† (Absolute maximum)	1200* max

PEAK NEGATIVE-PULSE GRID-NO.1 VOLTAGE	-250 max
PEAK CATHODE CURRENT	75 max
AVERAGE CATHODE CURRENT	25 max
PLATE DISSIPATION	7 max
PEAK HEATER-CATHODE VOLTAGE:	
Heater negative with respect to cathode	200 max
Heater positive with respect to cathode	200 max

Maximum Circuit Value:

Grid-No.1-Circuit Resistance:	
For cathode-bias operation	2.2 max megohms
* Grid No.2 connected to plate.	
† The duration of the voltage pulse must not exceed 15 per cent of one vertical scanning cycle. In a 625-line, 30-frame system, 15 per cent of one vertical scanning cycle is 2.5 milliseconds.	
‡ Under no circumstances should this absolute value be exceeded.	
■ The dc component must not exceed 100 volts.	

REMOTE-CUTOFF PENTODE

Metal type 6K7 and glass octal types 6K7-G and 6K7-GT used in rf and if stages of radio receivers, particularly in those employing avc. Outlines 3, 23, and 15A, respectively, OUTLINES SECTION. These tubes require octal socket and may be mounted in any position. For electrode voltage supplies and application, refer to type 6SK7. Heater volts (ac/dc), 6.3; amperes, 0.3. Typical operation as class A₁ amplifier: plate volts 250 (300 max); grid-No.3 connected to cathode at socket; grid-No.2 supply volts, 300 max; grid-No.2 volts, 125; grid-No.1 volts, -3; plate resistance, 0.6 megohm; transconductance, 1650 amhos; plate ma., 10.5; grid-No.2 ma., 2.6; plate dissipation, 2.75 max watts; grid-No.2 input, 0.35 max watts. Types 6K7 and 6K7-GT are used principally for renewal purposes. Type 6K7-G is a DISCONTINUED type listed for reference only.

6K7
6K7G
6K7GT

Relative type:
12K7GT

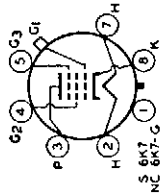

TRIODE-HEXODE CONVERTER

Metal type 6K8 and glass octal types 6K8-G and 6K8-GT used as combined triode oscillator and hexode mixer tubes in radio receivers. Type 6K8, Outline 4; type 6K8-G, Outline 23, OUTLINES SECTION. Tubes require octal socket. Heater volts (ac/dc), 6.3; amperes, 0.3. Typical operation in converter service: hexode plate volts, 250 (300 max); hexode grids-No.2 and-No.4 volts, 100 (150 max); hexode grid-No.3 volts, -3 (0 max); triode plate volts, 100 (125 max); triode grid resistor, 50000 ohms; hexode plate resistance (approx.), 0.6 megohm; conversion transconductance, 350 μmhos; hexode plate ma., 3.8; triode grid and hexode grid-No.1 ma., 0.15; total cathode ma., 12.5 (16 max). Types 6K8-G and 6K8-GT are DISCONTINUED types listed for reference only. Type 6K8 is used principally for renewal purposes.

6K8
6K8G
6K8GT

Related type:
12K8

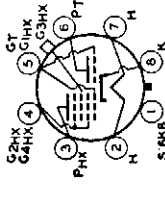

THREE-UNIT TRIODE

Duodecar type containing one medium-mu and two high-mu triode units used as combined agc, sync, and noise-inverter tube in television receivers employing series-connected heater strings. Outline 12A, OUTLINES SECTION. Tube requires duodecar 12-contact socket and may be mounted in any position. Heater volts (ac/dc), 6.3; amperes, 0.6; warm-up time (average), 11 seconds.

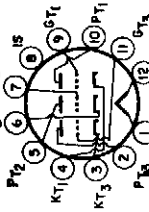

6K11

CLASS A₁ AMPLIFIER

Maximum Ratings, (Design-Maximum Values):

PLATE VOLTAGE	330 max
GRID VOLTAGE	-50 max
Negative-bias value	0 max
CATHODE CURRENT	20 max
PLATE DISSIPATION	2.75 max

Units Nos.
2 and 3

Unit
No.1

330 max

-50 max

0 max

20 max

2.75 max

330 max

-50 max

0 max

20 max

0.3 max

330 max

-50 max

0 max

20 max

0.3 max

330 max

-50 max

0 max

20 max

0.3 max

PEAK HEATER-CATHODE VOLTAGE:
 Heater negative with respect to cathode..... 200 max
 Heater positive with respect to cathode..... 200^o max

Characteristics:

Plate Voltage.....	250	volts
Grid Voltage.....	-8, -5	volts
Amplification Factor.....	17	
Plate Resistance (Approx.).....	7700	ohms
Transconductance.....	2200	μmhos
Plate Current.....	10.5	ma
Grid Voltage (Approx.) for plate current of 10 μa.....	-24	

^o The dc component must not exceed 100 volts.

HIGH- μ U TRIODE— SHARP-CUTOFF PENTODE

6KA8
 Related type: 8KA8

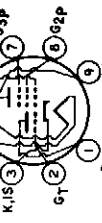

Miniature type used in color and black-and-white television receivers employing series-connected heater strings. The triode unit is used in sync-separator circuits; the pentode unit has two independent control grids and is used in gated-agg-amplifier and noise-inverter circuits. Outline 8D, OUTLINES SECTION. Tube requires miniature nine-contact socket and may be mounted in any position. For curves of average plate characteristics for triode unit, refer to type 6AW8-A.

HEATER VOLTAGE (A/C)..... 6.3 volts

HEATER CURRENT..... 0.6 ampere

HEATER WARM-UP TIME (AVERAGE)..... 11 seconds

DIRECT INTERELECTRODE CAPACITANCES:

Triode Unit:		
Grid to Plate.....	2.2	pf
Grid to Cathode, Heater, and Internal Shield.....	2.8	pf
Plate to Cathode, Heater, and Internal Shield.....	2.2	pf
Pentode Unit:		
Grid-No.1 to Plate.....	0.1	max
Grid No.1 to Cathode, Heater, Grid No.2, and Internal Shield.....	9.5	pf
Grid No.1 to Grid No.3.....	0.5	pf
Grid No.3 to Plate.....	2.2	pf
Grid No.3 to All Other Electrodes, Heater, and Internal Shield.....	7	pf

CLASS A₁ AMPLIFIER

Maximum Ratings, (Design-Maximum Values):

PLATE VOLTAGE.....	300 max	volts
GRID VOLTAGE.....	0 max	volts
Grid Voltage.....	-50 max	volts
Positive-bias value.....		
Negative-bias value.....		

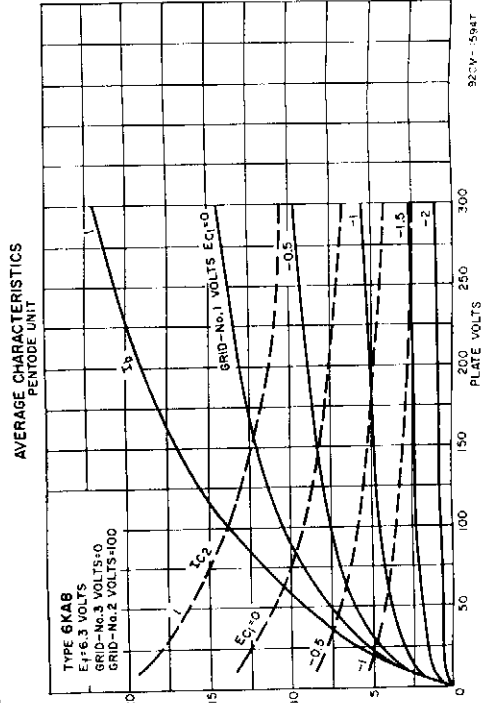

PLATE DISSIPATION..... 1.1 max watts

PEAK HEATER-CATHODE VOLTAGE:
 Heater negative with respect to cathode..... 200 max volts
 Heater positive with respect to cathode..... 200^o max volts

Characteristics:

Plate Supply Voltage.....	150	volts
Grid-No.3 Supply Voltage.....	0	volts
Grid-No.2 Supply Voltage.....	100	volts
Grid-No.1 Supply Voltage.....	-2	volts
Cathode-Bias Resistor.....	180	ohms
Amplification Factor.....	70	
Plate Resistance (Approx.).....	17500	ohms
Transconductance, Grid No.1 to Plate.....	4000	μmhos
Transconductance, Grid No.3 to Plate.....	600	μmhos
Plate Current.....	4	ma
Grid-No.2 Current.....	4	ma
Grid-No.4 Supply Voltage (Approx.): For plate current of 10 μa.....	-5	
For plate current of 20 μa.....	-4	
Grid-No.3 Supply Voltage (Approx.) for plate current of 20 μa.....	-7	

Maximum Circuit Values:

Grid-Circuit Resistance:
 For fixed-bias operation.....
 For cathode-bias operation.....

GATED AGC AMPLIFIER AND NOISE INVERTER

Maximum Ratings, (Design-Maximum Values):

DC PLATE VOLTAGE.....	300 max	volts
PEAK POSITIVE-PULSE PLATE VOLTAGE.....	600 max	volts
GRID-No.3 (CONTROL-GRID) VOLTAGE: Positive-bias value.....	0 max	volts
Negative-bias value.....	-100 max	volts
GRID-No.2 (SCREEN-GRID) SUPPLY VOLTAGE.....	300 max	volts
GRID-No.2 VOLTAGE.....	See curve page 70	
GRID-No.1 (CONTROL-GRID) VOLTAGE: Positive-bias value.....	0 max	volts
Negative-bias value.....	-50 max	volts
PLATE DISSIPATION.....	2 max	watts
GRID-No.2 INPUT: For grid-No.2 voltages up to 150 volts.....	1.1 max	watts
For grid-No.2 voltages between 150 and 300 volts.....	See curve page 70	
PEAK HEATER-CATHODE VOLTAGE: Heater negative with respect to cathode.....	200 max	volts
Heater positive with respect to cathode.....	200 ^o max	volts

AVERAGE CHARACTERISTICS
PENTODE UNIT

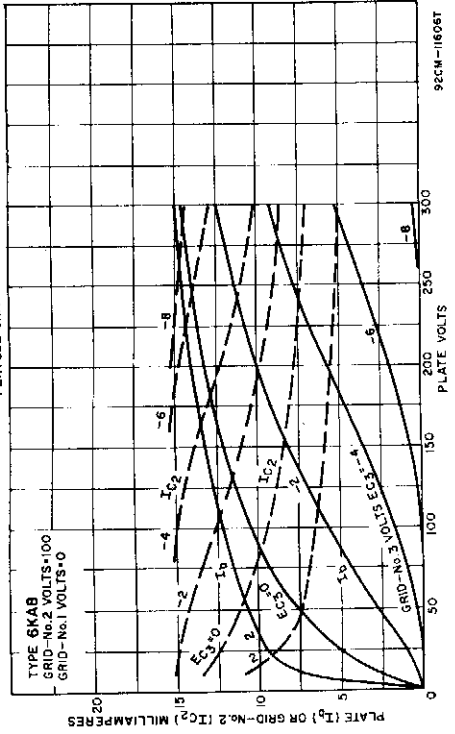

PENTODE UNIT:

Grid No. 1 to Plate.....	0.015 maz	pf
Grid No. 1 to Cathode, Heater, Grid No. 2, Grid No. 3, and Internal Shield.....	5	pf
Plate to Cathode, Heater, Grid No. 2, Grid No. 3, and Internal Shield.....	3.4	pf
Heater to Triode Cathode and Pentode Cathode.....	5.5*	pf

CLASS A₁ AMPLIFIER

Maximum Ratings, (Design-Maximum Values):

PLATE VOLTAGE.....	Triode	Pentode
GRID-NO. 2 (SCREEN-GRID) SUPPLY VOLTAGE.....	280 maz	280 maz
GRID-NO. 2 VOLTAGE.....	0 maz	0 maz
GRID-NO. 1 (CONTROL-GRID) VOLTAGE, Positive-bias value	20 maz	20 maz
CATHODE CURRENT.....	2 maz	2 maz
PLATE DISSIPATION.....	0.5 maz	0.5 maz
GRID-NO. 2 INPUT:		
For grid-No.2 voltages up to 140 volts.....		See curve page 70
For grid-No.2 voltages between 140 and 280 volts.....		See curve page 70
PEAK HEATER-CATHODE VOLTAGE:		
Heater negative with respect to cathode.....	200 maz	200 maz
Heater positive with respect to cathode.....	200* maz	200* maz

AVERAGE PLATE CHARACTERISTICS

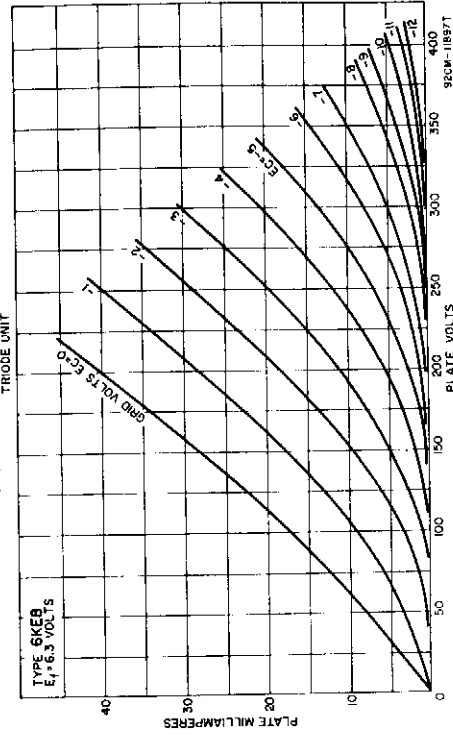

AVERAGE CHARACTERISTICS

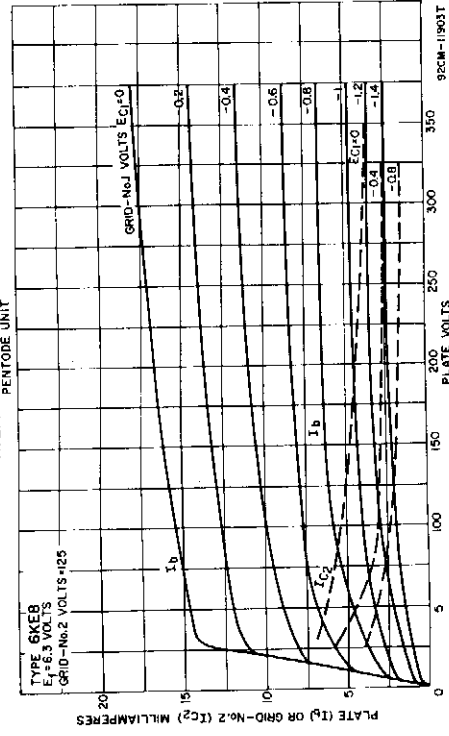

Maximum Circuit Values:

Grid-No.3-Circuit Resistance..... 0.68 maz megohm

Grid-No.1-Circuit Resistance: 0.5 maz megohm

For fixed-bias operation..... 1 maz megohm

For cathode-bias operation.....

*The duration of the voltage pulse must not exceed 15 per cent of one horizontal scanning cycle. In a 525-line, 30-frame system, 15 per cent of one horizontal scanning cycle is 10 microseconds.

*The dc component must not exceed 100 volts.

MEDIUM-MU TRIODE SHARP-CUTOFF PENTODE

Miniature type used as combined vhf oscillator and mixer tube in television receivers. Outline 8B, OUTLINES SECTION. Tube requires miniature nine-contact socket and may be mounted in any position. Heater volts (ac/dc), 6.3; amperes, 0.4.

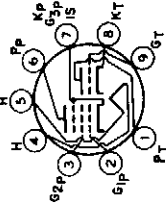

CLASS A₁ AMPLIFIER

Maximum Ratings, (Design-Maximum Values):

PLATE VOLTAGE.....	Triode	Pentode
GRID-NO. 2 (SCREEN-GRID) SUPPLY VOLTAGE.....	330 maz	330 maz
GRID-NO. 2 VOLTAGE.....	0 maz	0 maz
GRID-NO. 1 (CONTROL-GRID) VOLTAGE, Positive-bias value	2.5 maz	2.5 maz
PLATE DISSIPATION.....	0.55 maz	0.55 maz
GRID-NO. 2 INPUT:		
For grid-No.2 voltages up to 165 volts.....		See curve page 70
For grid-No.2 voltages between 165 and 330 volts.....		See curve page 70
PEAK HEATER-CATHODE VOLTAGE:		
Heater negative with respect to cathode.....	200 maz	200 maz
Heater positive with respect to cathode.....	200* maz	200* maz

Characteristics:

Plate Voltage.....	125 volts
Grid-No.2 Voltage.....	110 volts
Grid-No.1 Voltage.....	-1 volt
Amplification Factor.....	40
Plate Resistance (Approx.).....	7500 megohm
Transconductance.....	18.5 μmhos
Plate Current.....	9.5 ma
Grid-No.2 Current.....	3.5 ma
Grid-No.1 Voltage (Approx.) for plate current of 20 μa.....	-8 volts

Maximum Circuit Values:

Grid-No.1-Circuit Resistance: 0.5 maz megohm
For fixed-bias operation..... 1 maz megohm
For cathode-bias operation.....

MEDIUM-MU TRIODE SHARP-CUTOFF PENTODE

Miniature type with frame-grid pentode unit used as combined oscillator-mixer tube in television receivers using an intermediate frequency in the order of 40 megacycles. Outline 8B, OUTLINES SECTION. Tube requires miniature nine-contact socket and may be mounted in any position.

6KE8
SKEB

HEATER VOLTAGE (AC/DC).....	6.3 volts
HEATER CURRENT.....	0.4 ampere
DIRECT INTERELECTRODE CAPACITANCES: ¹⁰	
Triode Unit:	
Grid to Plate.....	1.3 pf
Grid to Cathode, Heater, Pentode Cathode, Pentode Grid	
Grid No.3, and Internal Shield.....	2.4 pf
Plate to Cathode, Heater, Pentode Cathode, Pentode	
Grid No.3, and Internal Shield.....	2 pf

Triode Unit	Pentode Unit
Plate Supply Voltage.....	volts
Grid-No. 2 Supply Voltage.....	125 volts
Grid-No. 1 Supply Voltage.....	125 volts
Cathode-Bias Resistor.....	0 ohms
Amplification Factor.....	68
Plate Resistance (Approx.).....	5000 ohms
Transconductance.....	8000 μ mhos
Plate Current.....	13 ma
Grid-No. 1 Voltage (Approx.).....	5 volts
For plate current of 50 μ A.....	-3 volts

Maximum Circuit Values:

Grid-No. 1-Circuit Resistance: For fixed-bias operation.....	0.5 max	0.25 max	megohm
For cathode-bias operation.....	1 max	0.5 max	megohm
With external shield connected to cathode of unit under test, except as noted.			
With external shield connected to ground.			
dc component must not exceed 100 watts.			

**DIODE—
SHARP-CUTOFF PENTODE**

6KL8

Related type:
12KL8

Miniature type used in combined if-amplifier and AM-detector service in AM and AM-FM broadcast receivers. Pentode unit may also be used as an rf- or if-amplifier or limiter tube;

the diode unit may be used for AVC or detection. Outline 8D, OUTLINES SECTION. Tube requires miniature nine-contact socket and may be mounted in any position. For curves of average plate characteristics for pentode unit, refer to type 6AUGA.

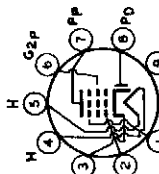

HEATER VOLTAGE (AC/DC).....	6.3 volts
HEATER CURRENT.....	0.3 ampere
DIRECT INTERELECTRODE CAPACITANCES: Pentode Unit:	
Grid No. 1 to Plate.....	0.002 max pf
Grid No. 1 to Cathode, Heater, Grid No. 2, Grid No. 3 and Internal Shield.....	6 pf
Plate to Cathode, Heater, Grid No. 2, Grid No. 3, and Internal Shield.....	5 pf
Pentode Grid No. 1 to Diode Plate.....	0.0015 max pf
Pentode Plate to Diode Plate.....	0.09 pf

PENTODE UNIT AS CLASS A₁ AMPLIFIER

Maximum Ratings, (Design-Maximum Values):	
PLATE VOLTAGE.....	300 max volts
GRID-NO.3 (SUPPRESSOR-GRID) VOLTAGE: Negative value.....	-300 max volts
Positive value.....	300 max volts
GRID-NO.2 (SCREEN-GRID) SUPPLY VOLTAGE	300 max volts
GRID-NO.2 VOLTAGE.....	See curve page 70
GRID-NO.1 (CONTROL-GRID) VOLTAGE: Positive-bias value.....	0 max volts
Negative-bias value.....	-50 max volts
GRID-NO.3 INPUT.....	0.2 max watt
GRID-NO.2 INPUT: For grid-No.2 voltages up to 150 volts. For grid-No.2 voltages between 150 and 300 volts.....	0.6 max watt
PLATE DISSIPATION.....	See curve page 70
PEAK HEATER-CATHODE VOLTAGE: Heater negative with respect to cathode.....	3 max watts
Heater positive with respect to cathode.....	200 max volts
BULB TEMPERATURE (At hottest point).....	200 max volts 150 max $^{\circ}$ C

Characteristics:	
Plate Voltage.....	100 volts
Grid No. 3.....	Connected to cathode at socket
Internal Shield.....	Connected to cathode at socket
Grid-No.2 Voltage.....	100 volts

Grid-No.1 Supply Voltage.....	0 volts
Grid-No.1 Resistor (Bypassed).....	2.2 megohms
Plate Resistance (Approx.).....	0.55 megohm
Transconductance.....	4300 μ mhos
Plate Current.....	5.5 ma
Grid-No.2 Current.....	2.2 ma
Grid-No.1 Voltage (Approx.) for plate current of 10 μ A.....	4.2 volts

DIODE UNIT

Maximum Ratings, (Design-Maximum Values):

PLATE CURRENT.....	1 max ma
PEAK HEATER-CATHODE VOLTAGE: Heater negative with respect to cathode.....	200 max volts
Heater positive with respect to cathode.....	200 max volts
Characteristics, Instantaneous Value: Tube Voltage Drop for plate current of 2 ma.....	10 volts
The dc component must not exceed 100 watts.	

**DIODE—
THREE-PLATE TETRODE**

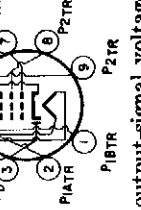

Miniature type used in frequency-divider and complex-wave generator circuits of electronic musical instruments. In such circuits the tetrode unit can provide three independent

output-signal voltages; the diode unit can be used as a key in a vibrato circuit. Outline 8D, OUTLINES SECTION. Tube requires miniature nine-contact socket and may be mounted in any position.

6KM8

HEATER VOLTAGE (AC/DC).....	6.3 volts
HEATER CURRENT.....	0.3 ampere
DIRECT INTERELECTRODE CAPACITANCES: Tetrode Unit:	
Grid No.1 to Plate No.1A.....	0.02 max pf
Grid No.1 to Plate No.1B.....	0.02 max pf
Grid No.1 to Plate No.2.....	0.06 max pf
Grid No.1 to Cathode, Heater, Grid No.2, and Internal Shield.....	5.5 pf
Plate No.1A to Cathode, Heater, Grid No.2, and Internal Shield.....	1.2 pf
Plate No.1B to Cathode, Heater, Grid No.2, and Internal Shield.....	1.3 pf
Plate No.2 to Cathode, Heater, Grid No.2, and Internal Shield.....	1.8 pf
Tetrode Grid No.1 to Diode Plate.....	0.024 max pf
Tetrode Plate No.1A to Diode Plate.....	0.18 pf
Tetrode Plate No.1B to Diode Plate.....	0.024 pf
Tetrode Plate No.2 to Diode Plate.....	0.013 pf

AVERAGE CHARACTERISTICS

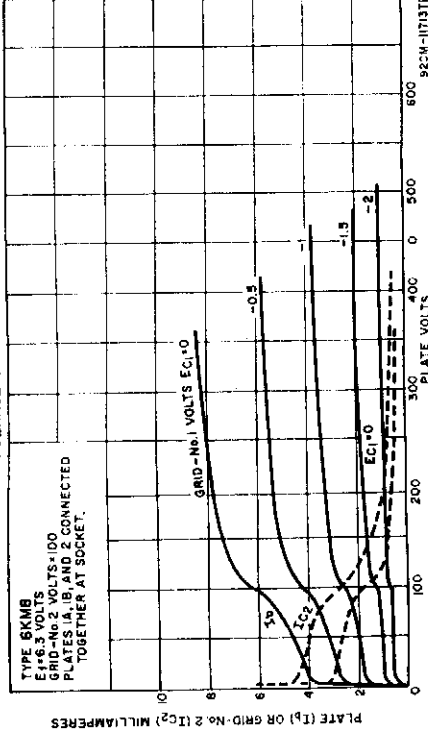

TETRODE UNIT AS CLASS A₁ AMPLIFIER
Plates No. 1A, 1B, and 2 connected together

Characteristics:

Plate Voltage.....	100	volts
Grid-No.2 Voltage.....	100	volts
Grid-No.1 Supply Voltage.....	0	volts
Grid-No.1 Resistor (Bypassed).....	2.2	megohms
Plate Resistance (Approx.).....	30000	ohms
Transconductance.....	3400	μmhos
Plate Current.....	4.2	ma
Grid-No.2 Current.....	1.7	ma
Grid-No.1 Voltage (Approx.) for plate current of 20 μa.....	-4	volts

Triode Connection—Plates No.1A, 1B, and 2 connected to grid No. 2

Characteristics:

Plate Voltage.....	100	volts
Grid-No.1 Supply Voltage.....	2.2	volts
Grid-No.1 Resistor (Bypassed).....	2.2	megohms
Transconductance.....	4500	μmhos
Amplification Factor.....	45	
Plate Current.....	5.5	ma

Separate plate operation; plates not under test grounded

Plate	IA	IB	
Plate Voltage.....	100	100	2
Grid-No.2 Voltage.....	100	100	100
Grid-No.1 Supply Voltage.....	0	0	0
Grid-No.1 Resistor (Bypassed).....	2.2	2.2	2.2
Transconductance.....	2000	2000	1800
Plate Resistance (Approx.).....	0.1	0.1	0.12
Plate Current.....	2.3	2.3	2.1
Grid-No.2 Current.....	3.8	3.8	3.3

TETRODE UNIT AS FREQUENCY DIVIDER AND COMPLEX-WAVE GENERATOR

Maximum Ratings, (Design-Maximum Values):

Plate Voltage (Each plate).....	330 maz
Grid-No.2 (SCREEN-GRID) SUPPLY VOLTAGE.....	330 maz
Grid-No.2 VOLTAGE.....	See curve page 70
Grid-No.1 (CONTROL-GRID) VOLTAGE.....	
Positive-bias value.....	0 maz
Negative-bias value.....	-50 maz
Grid-No.2 INPUT: For grid-No.2 voltages up to 165 volts.....	
For grid-No.2 voltages between 165 and 330 volts.....	0.65 maz
Plate Dissipation (Each plate).....	1 maz
Peak Heater-Cathode Voltages: Heater negative with respect to cathode.....	200 maz
Heater positive with respect to cathode.....	200 ^m maz

AVERAGE PLATE CHARACTERISTICS

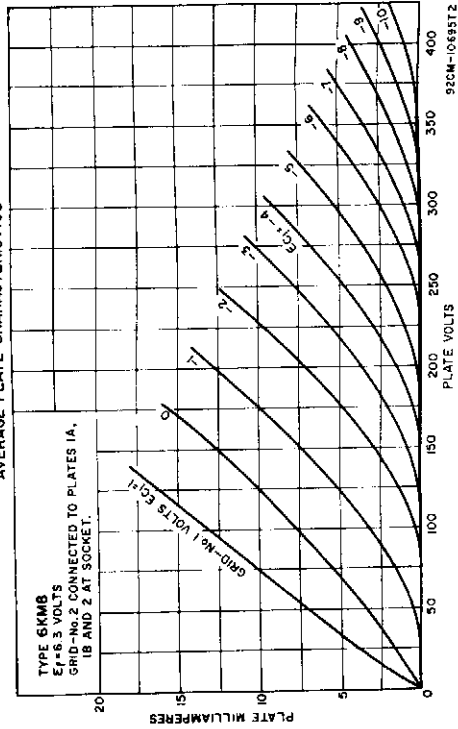

Maximum Circuit Values:

Grid-No.1-Circuit Resistance: For grid-No.1-resistor-bias operation.....	2.2 maz	megohms
DIODE UNIT		
Maximum Ratings, (Design-Maximum Values):		
Plate Current.....	1 maz	ma
Characteristics, Instantaneous Values:		
Tube Voltage Drop for plate current of 2 ma.....	10	volts
■The dc component must not exceed 100 volts.		

**HIGH-MU TRIODE—
SHARP-CUTOFF PENTODE**

Miniature type used in a variety of applications in television receivers. The pentode unit is used as an if-amplifier tube, and the triode unit as a sync-separator or voltage-amplifier tube. Outline 8B, OUTLINES SECTION. Tube requires miniature nine-contact socket and may be mounted in any position. Heater volts (ac/dc), 6.3; amperes, 0.6.

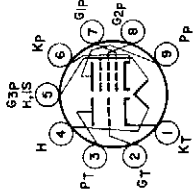

CLASS A₁ AMPLIFIER

Maximum Ratings, (Design-Maximum Values):

Plate Voltage.....	330 maz	volts
Grid-No.2 (SCREEN-GRID) SUPPLY VOLTAGE.....	330 maz	volts
Grid-No.2 VOLTAGE.....	See curve page 70	volts
Grid-No.1 (CONTROL-GRID) VOLTAGE, Positive-bias value.....	0 maz	volts
Grid-No.2 INPUT: For grid-No.2 voltages up to 165 volts.....		
For grid-No.2 voltages between 165 and 330 volts.....	0.55 maz	watt
Peak Heater-Cathode Voltage: Heater negative with respect to cathode.....	200 maz	volts
Heater positive with respect to cathode.....	200 ^m maz	volts

Characteristics:

Plate Voltage.....	250	volts
Grid-No.2 Voltage.....	250	volts
Grid-No.1 Voltage.....	-2	volts
Amplification Factor.....	100	
Plate Resistance (Approx.).....	31500	ohms
Transconductance.....	3200	μmhos
Plate Current.....	1.8	ma
Grid-No.2 Current.....	4.5	ma
Grid-No.1 Voltage (Approx.) for plate current of 20 μa.....	-3.5	volts
Maximum Circuit Values:		
Grid-No.1-Circuit Resistance: For fixed-bias operation.....	0.5 maz	megohm
For cathode-bias operation.....	1 maz	megohm

**HIGH-MU TRIODE—
SHARP-CUTOFF PENTODE**

Miniature type with frame-grid pentode unit used in black-and-white television receivers. The triode unit is used in general-purpose voltage-amplifier, sync-separator, and sound-if-amplifier applications. The pentode unit is used as a video output tube. Outline 8D, OUTLINES SECTION. Tube requires miniature nine-contact socket and may be mounted in any position. For curves of average plate characteristics for triode unit, refer to type 6AW8-A.

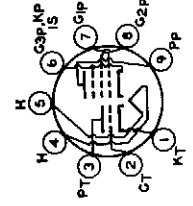

Maximum Ratings, (Design-Maximum Values):

Plate Voltage.....	250	volts
Grid-No.2 Voltage.....	250	volts
Grid-No.1 Voltage.....	-2	volts
Amplification Factor.....	100	
Plate Resistance (Approx.).....	31500	ohms
Transconductance.....	3200	μmhos
Plate Current.....	1.8	ma
Grid-No.2 Current.....	4.5	ma
Grid-No.1 Voltage (Approx.) for plate current of 20 μa.....	-3.5	volts
Maximum Circuit Values:		
Grid-No.1-Circuit Resistance: For fixed-bias operation.....	0.5 maz	megohm
For cathode-bias operation.....	1 maz	megohm

6KV8
Related Type:
11KV8

Heater Voltage (AC/DC).....	6.3	volts
Heater Current.....	0.775	amperes
Direct Inter-Electrode Capacitances (Approx.):		
Triode Unit.....		
Grid to Plate.....	3.7	pf

Grid to Cathode, Heater, Pentode Cathode, Pentode Grid No.3, and Internal Shield	2.5	pf
Plate to Cathode, Heater, Pentode Cathode, Pentode Grid No.3, and Internal Shield	2.4	pf
Pentode Grid to Pentode Plate	0.015	max
Grid No.1 to Plate	0.09	max
Grid No.1 to Cathode, Heater, Grid No.2, Grid No.3, and Internal Shield	13	pf
Plate to Cathode, Heater, Grid No.2, Grid No.3, and Internal Shield	4.8	pf
Pentode Plate to Triode Plate	0.17	max

CLASS A₁ AMPLIFIER

Maximum Ratings, (Design-Maximum Values):	Triode Unit	Pentode Unit
PLATE VOLTAGE	300 max	300 max
GRID-NO.2 (SCREEN-GRID) SUPPLY VOLTAGE	—	300 max
GRID-NO.2 VOLTAGE	—	See curve page 70
GRID-NO.1 (CONTROL-GRID) VOLTAGE, Positive-bias value	0 max	0 max
PLATE DISSIPATION	1 max	5 max
GRID-NO.2 INPUT:		
For grid-No.2 voltages up to 150 volts	—	1 max
For grid-No.2 voltages between 150 and 300 volts	—	See curve page 70
PEAK HEATER-CATHODE VOLTAGE:		
Heater negative with respect to cathode	200 max	200 max
Heater positive with respect to cathode	200*max	200*max

Characteristics:

Plate Supply Voltage	200	125	200	volts
Grid-No.2 Supply Voltage	—	125	125	volts
Grid-No.1 Supply Voltage	-2	0	0	volts
Cathode-Bias Resistor	—	82	68	ohms
Amplification Factor	70	—	—	
Plate Resistance (Approx.)	17500	55000	75000	ohms
Transconductance	4000	21000	23000	μmhos
Plate Current	4	16.5	19	ma
Grid-No.2 Current	—	3.1	3.1	ma
Grid-No.1 Voltage (Approx.) for plate current of 100 μa	-4.5	-3.8	-3.8	volts

Maximum Circuit Values:

Grid-No.1-Circuit Resistance: 0.5 max 0.1 max megohm
 For fixed-bias operation 1 max 0.25 max megohm
 For cathode-bias operation

* The dc component must not exceed 100 volts.

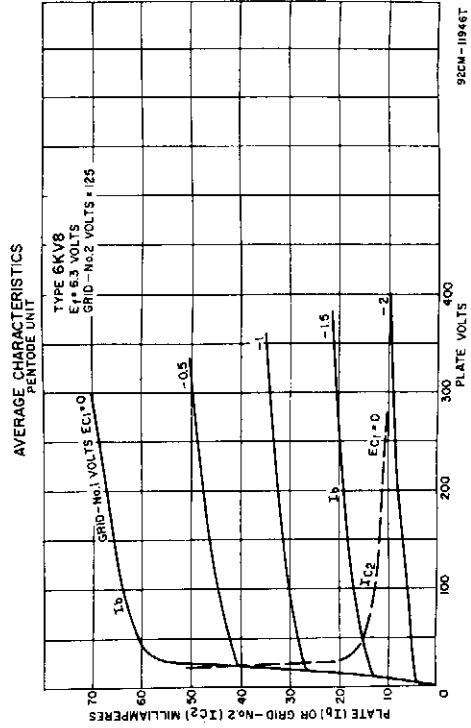

MEDIUM-MU TRIODE

Glass octal type used as detector, amplifier, or oscillator in radio receivers. Outline 22, OUTLINES SECTION. Heater volts (ac/dc), 6.3; amperes, 0.15. Typical operation and characteristics: plate volts, 250 max; grid volts, -9; plate resistance, 9000 ohms; amplification factor, 17; transconductance, 1900 μmhos; grid voltage for cathode-current cutoff, -20. This is a DISCONTINUED type listed for reference only.

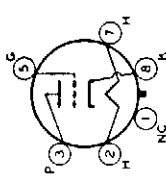

6L5G

BEAM POWER TUBE

Metal type 6L6 and glass octal types 6L6-G, 6L6-GB, 6L6-GC are used in the output stage of audio amplifying equipment, especially units designed to have ample reserve of power-delivering ability. These types provide high power output, sensitivity, and high efficiency. Power output at all levels has low third- and higher-order harmonics. Type 6L6, Outline 6; types 6L6-GB and 6L6-GC, Outline 19C; OUTLINES SECTION. Tubes require an octal socket and may be mounted in any position. It is especially important that these tubes, like other power-handling tubes, be adequately ventilated. Type 6L6-G is a DISCONTINUED type listed for reference only. Type 6L6-GC can be used in place of types 6L6, 6L6-G, and 6L6-GB. Type 6L6-GC may be supplied with pin 1 omitted.

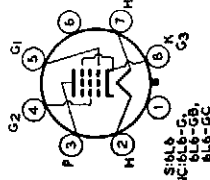

6L6
6L6G
6L6GB
6L6GC

HEATER VOLTAGE (AC/DC)..... 6.3 volts
 HEATER CURRENT..... 0.9 ampere
 DIRECT INTERELECTRODE CAPACITANCES (Approx.):
 6L6-G 6L6-GB
 Grid No.1 to Plate..... 0.4 pf
 Grid No.1 to Cathode, Heater, Grid No.2, and Grid No.3..... 10 pf
 Plate to Cathode, Heater, Grid No.2, and Grid No.3..... 12 pf
 * With pin 1 connected to pin 8.

CLASS A₁ AMPLIFIER	6L6, 6L6-G, 6L6-GB, 6L6-GC	Design-Center Designer-Maximum Values
PLATE VOLTAGE	360 max	500 max
GRID-NO.2 (SCREEN-GRID) VOLTAGE	270 max	450*max
PLATE DISSIPATION	19 max	30 max
GRID-NO.2 INPUT	2.5 max	5 max
PEAK HEATER-CATHODE VOLTAGE:		
Heater negative with respect to cathode	180 max	200 max
Heater positive with respect to cathode	180 max	200 max

CLASS A₁ AMPLIFIER (Triode Connection)

Typical Operation:	6L6, 6L6-G, 6L6-GB, 6L6-GC	Design-Center Designer-Maximum Values
Plate Voltage	250	350
Grid-No.2 Voltage	250	250
Grid-No.1 (Control-Grid) Voltage	-14	-18
Peak AF Grid-No.1 Voltage	14	12.5
Zero-Signal Plate Current	72	54
Maximum-Signal Plate Current	79	66
Zero-Signal Grid-No.2 Current	5	2.5
Maximum-Signal Grid-No.2 Current	7.3	4.7
Plate Resistance (Approx.)	22500	35000
Transconductance	6000	5200
Load Resistance	2500	4200
Total Harmonic Distortion	10	15
Maximum-Signal Power Output	6.5	10.8

Maximum Ratings:	6L6, 6L6-G, 6L6-GB, 6L6-GC	Design-Center Designer-Maximum Values
PLATE VOLTAGE	360 max	500 max
GRID-NO.2 (SCREEN-GRID) VOLTAGE	270 max	450*max
PLATE DISSIPATION	19 max	30 max
GRID-NO.2 INPUT	2.5 max	5 max
PEAK HEATER-CATHODE VOLTAGE:		
Heater negative with respect to cathode	180 max	200 max
Heater positive with respect to cathode	180 max	200 max

CLASS A₁ AMPLIFIER (Triode Connection)

Maximum Ratings:	6L6, 6L6-G, 6L6-GB, 6L6-GC	Design-Center Designer-Maximum Values
PLATE VOLTAGE	275 max	450 max
PLATE DISSIPATION (TOTAL)	19 max	30 max

PEAK HEATER-CATHODE VOLTAGE:
Heater negative with respect to cathode..... 180 *max*
Heater positive with respect to cathode..... 180 *max*

Typical Operation:

Plate Voltage.....	250	volts
Grid-No.1 Voltage.....	-20	volts
Peak AF Grid-No.1 Voltage.....	20	volts
Zero-Signal Plate Current.....	40	ma
Maximum-Signal Plate Current.....	44	ma
Plate Resistance (Approx.).....	1700	ohms
Amplification Factor.....	8	
Transconductance.....	4700	μ hos
Load Resistance.....	5000	ohms
Total Harmonic Distortion.....	5	per cent
Maximum-Signal Power Output.....	1.4	watts

† Grid No.2 connected to plate.

PUSH-PULL CLASS A₁ AMPLIFIER

Maximum Ratings: (Same as for class A₁ amplifier)

Typical Operation (Values are for two tubes):

Plate Voltage.....	250	volts
Grid-No.2 Voltage.....	250	volts
Grid-No.1 Voltage.....	-16	volts
Peak AF Grid-No.1-to-Grid-No.1 Voltage.....	32	volts
Zero-Signal Plate Current.....	120	ma
Maximum-Signal Plate Current.....	140	ma
Zero-Signal Grid-No.2 Current.....	10	ma
Maximum-Signal Grid-No.2 Current.....	16	ma
Effective Load Resistance (Plate-to-plate).....	5000	ohms
Total Harmonic Distortion.....	2	per cent
Maximum-Signal Power Output.....	14.5	watts

PUSH-PULL CLASS AB₁ AMPLIFIER

Maximum Ratings: (Same as for class A₁ amplifier)

Typical Operation (Values are for two tubes):

Plate Voltage.....	360	volts
Grid-No.2 Voltage.....	270	volts
Grid-No.1 Voltage.....	-22.5	volts
Peak AF Grid-No.1-to-Grid-No.1 Voltage.....	45	volts
Zero-Signal Plate Current.....	88	ma
Maximum-Signal Plate Current.....	132	ma
Zero-Signal Grid-No.2 Current.....	5	ma
Maximum-Signal Grid-No.2 Current.....	15	ma
Effective Load Resistance (Plate-to-plate).....	6600	ohms
Total Harmonic Distortion.....	2	per cent
Maximum-Signal Power Output.....	26.5	watts

AVERAGE PLATE CHARACTERISTICS

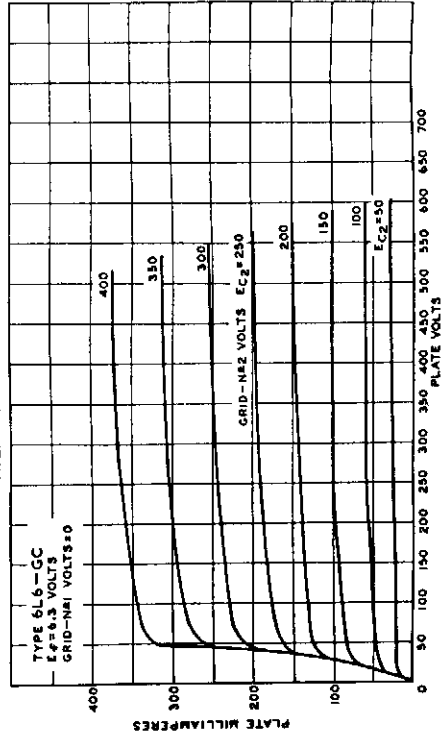

92CM-10327

PUSH-PULL CLASS AB₁ AMPLIFIER
Maximum Ratings: (Same as for class A₁ amplifier)

Typical Operation (Values are for two tubes):

Plate Voltage.....	360	volts
Grid-No.2 Voltage.....	270	volts
Grid-No.1 Voltage.....	-22.5	volts
Peak AF Grid-No.1-to-Grid-No.1 Voltage.....	52	volts
Zero-Signal Plate Current.....	78	ma
Maximum-Signal Plate Current.....	142	ma
Zero-Signal Grid-No.2 Current.....	3.5	ma
Maximum-Signal Grid-No.2 Current.....	11	ma
Effective Load Resistance (Plate-to-plate).....	6000	ohms
Total Harmonic Distortion.....	2	per cent
Maximum-Signal Power Output.....	31	watts

Maximum Circuit Values:

Grid-No.1-Circuit Resistance:

For fixed-bias operation..... 0.1 *max* megohm

For cathode-bias operation..... 0.5 *max* megohm

* In push-pull circuits where grid No.2 of each tube is connected to a tap on the plate winding of the output transformer, this maximum rating is 500 volts.

PENTAGRID MIXER

Metal type 6L7 and glass octal type 6L7-G used as mixers in superheterodyne circuits having a separate oscillator stage, as well as in other applications where dual control is desirable in a single stage. The two separate control grids are shielded from each other and the coupling effects between oscillator and signal circuits are very small. For additional information, refer to *Frequency Conversion, ELECTRON TUBE APPLICATIONS SECTION*. Outlines 3 and 23, *OUTLINES SECTION*. Heater volts (ac/dc), 6.3; amperes, 0.3. Typical operation as mixer (values recommended for all-wave receivers): plate volts, 250 (300 *max*); grids-No.2-and-No.4 volts, 150 *max*; grid-No.1 volts, -6 *min*; grid-No.3 volts, -15; peak oscillator volts applied to grid No.3, 18 *min*; plate dissipation, 1 *max* watt; grids-No.2-and-No.4 input, 1.5 *max* watts; plate *ma*, 3.3; grids-No.2-and-No.4 *ma*, 9.2; plate resistance, greater than 1 megohm; conversion transconductance, 380 μ hos. Type 6L7-G is a DISCONTINUED type listed for reference only. Type 6L7 is used principally for renewal purposes.

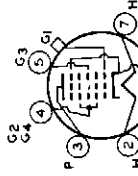

6L7

6L7G

6N5

Refer to type 6AB5/6N5

DIRECT-COUPLED POWER TRIODE

Glass octal type used as class A₁ power amplifier. Outline 26, *OUTLINES SECTION*. Heater volts (ac/dc), 6.3; amperes, 0.8. For electrical characteristics, refer to type 6B5. Type 6N6-G is a DISCONTINUED type listed for reference only.

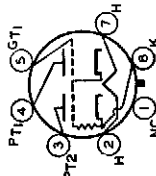

6N6G

MEDIUM-MU TWIN POWER TRIODE

Metal type 6N7 and glass octal type 6N7-GT used in output stage of radio receivers as class B power amplifier or with units in parallel as a class A₁ amplifier. Outlines 5 and 14C, respectively, *OUTLINES SECTION*. Tubes require octal socket. Heater volts (ac/dc), 6.3; amperes, 0.8. Typical operation as class A₁ amplifier: plate volts, 300 *max*; grid volts, -6; amplification factor, 35; plate resistance (approx.), 11000 ohms; transconductance, 3200 μ hos; plate *ma*, 7. Typical operation as push-pull class B power amplifier (both units): plate volts, 300 *max*; plate-supply impedance, 1000 ohms; effective grid-circuit impedance, 516 ohms; grid volts, 0; peak af grid-to-grid volts, 82; plate *ma*, 35 (zero signal), 70 (maximum signal); peak grid *ma*, (each unit), 22; effective load resistance (plate to plate), 8000 ohms; maximum-signal power output, 10 watts. These types are used principally for renewal purposes.

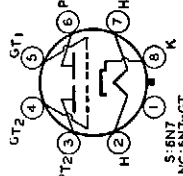

6N7

6N7GT

REMOTE-CUTOFF PENTODE

Metal type 6S7 and glass octal type 6S7-G used in rf and if stages of automobile receivers employing avc. Outlines 4 and 23, respectively, OUTLINES SECTION. Type 6S7 is used principally for renewal purposes. Type 6S7-G is a DISCONTINUED type listed for reference only. Tubes require octal socket. Heater volts, 6.3; ampere, 0.15. Typical operation as Class A1 amplifier: plate volts, 250 (300 maz); grid-No.2 supply volts, 300 maz; grid-No.1 volts, -3 (0 maz); grid No.3 connected to cathode at socket; plate ma., 8.5; grid-No.2 ma., 2; plate resistance (Approx.), 1.0 meg-ohm; transconductance, 1760 μ mhos; plate dissipation, 2.25 maz watts; grid-No.2 input; for grid-No.2 voltages up to 150 volts, 0.25 maz watt; for grid-No.2 voltages between 150 and 300 volts, see curve page 66. Peak heater-cathode volts, 90 maz.

6S7
6S7G

No.2 volts, see curve page 66; grid-No.2 supply volts, 300 maz; grid-No.1 volts, -3 (0 maz); grid No.3 connected to cathode at socket; plate ma., 8.5; grid-No.2 ma., 2; plate resistance (Approx.), 1.0 meg-ohm; transconductance, 1760 μ mhos; plate dissipation, 2.25 maz watts; grid-No.2 input; for grid-No.2 voltages up to 150 volts, 0.25 maz watt; for grid-No.2 voltages between 150 and 300 volts, see curve page 66. Peak heater-cathode volts, 90 maz.



TRIPLE DIODE—HIGH-MU TRIODE

Glass octal type used as audio amplifier, AM detector, and FM detector in AM/FM receivers. Diode unit No.2 is used for AM detection, and diode units No.1 and No.3 are used for FM detection. Outline 15A, OUTLINES SECTION, except over-all length is 3-5/8 maz inches and seated height is 3-1/16 maz inches. Tube requires octal socket. Heater volts(ac/dc), 6.3; ampere, 0.3. Typical operation of triode unit as class A1 amplifier: plate volts, 250 (300 maz); grid volts, -2; amplification factor, 100; plate resistance (Approx.), 91000 ohms; transconductance, 1100 μ mhos; plate dissipation, 0.5 maz watt; plate ma., 0.9; peak heater-cathode volts, 90 maz. Maximum plate ma. for diode units, 1.0 maz (each unit). Peak heater-cathode volts (diode unit No.1), 90 maz. For diode operation curves, refer to type 6AV6. Type 6S8-GT is used principally for renewal purposes.

6S8GT
Related type:
1258GT

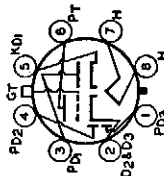

PENTAGRID CONVERTER

Metal type 6SA7 and glass octal type 6SA7-GT used as converters in superheterodyne circuits. They are similar in performance to type 6BE6. For general discussion of pentagrid types, see Frequency Conversion in ELECTRON TUBE APPLICATIONS SECTION. Both tubes have excellent frequency stability. Tubes require octal socket and may be mounted in any position. Outlines 2 and 14C, respectively, OUTLINES SECTION. Type 6SA7-GT is used principally for renewal purposes.

6SA7

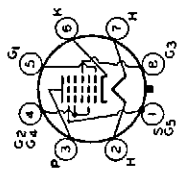

6SA7GT
Related types:
12SA7, 12SA7GT

HEATER VOLTAGE (AC/DC)..... volts
HEATER CURRENT..... amperes
DIRECT INTERELECTRODE CAPACITANCES FOR 6SA7:
Grid No.3 to All Other Electrodes (Mixer Output)..... pf
Plate to All Other Electrodes (RF Input)..... pf
Grid No.1 to All Other Electrodes (Osc. Input)..... pf
Grid No.3 to Plate..... pf
Grid No.3 to Grid No.1..... pf
Grid No.1 to Plate..... pf
Grid No.1 to Shell, Grid No.5, and All Other Electrodes except Cathode..... pf
Cathode to Shell, Grid No.5, and All Other Electrodes except Grid No.1..... pf
* With shell connected to cathode.

CONVERTER

Maximum Ratings, (Design-Center Values):
PLATE VOLTAGE..... volts
GRIDS-NO.2-AND-NO.4 (SCREEN-GRID) VOLTAGE..... volts

GRIDS-NO.2-AND-NO.4 SUPPLY VOLTAGE..... volts
GRID-NO.3 (CONTROL-GRID) VOLTAGE..... volts
Negative bias value..... 0 maz
Positive bias value..... 1.0 maz
PLATE DISSIPATION..... watt
GRIDS-NO.2-AND-NO.4 INPUT..... watt
CATHODE CURRENT..... ma
PEAK HEATER-CATHODE VOLTAGE..... volts
Heater negative with respect to cathode..... 90 maz
Heater positive with respect to cathode..... 90 maz

Separate Excitation†

Typical Operation:
Plate Voltage..... 100
Grid No.5 and shell (6SA7 only)..... Connected to cathode at socket
Grids-No.2-and-No.4 Voltage..... 100
Grid-No.3 Voltage..... -2
Grid-No.1 (Oscillator-Grid) Resistor..... 20000
Plate Resistance (Approx.)..... 0.5
Conversion Transconductance..... 425
Grid-No.3 Voltage (Approx.) for transconductance of 10 μ mhos..... -25
Plate Current..... 3.3
Grids-No.2-and-No.4 Current..... 8.5
Grid-No.1 Current..... 0.5
Cathode Current..... 12.3
NOTE: The transconductance between grid No.1 and grids No.2 and No.4 connected to plate (not oscillating) is 4500 μ mhos under the following conditions: grids No.1, No.3 at 0 volts; grids No.2 and No.4 and plate at 100 volts; for 6SA7 only, grid No.5 and shell are connected to cathode at socket.
† The characteristics shown with separate excitation correspond very closely to those obtained in a self-excited oscillator circuit operating with zero bias.

PENTAGRID CONVERTER

Metal type used as converter in superheterodyne circuits. Because of its high conversion and oscillator transconductance, it is especially useful in FM converter service in the 100-megacycle region. The 6SB7-Y has a micaol base which minimizes drift in oscillator frequency during warm-up period. For general discussion of pentagrid types, see Frequency Conversion in ELECTRON TUBE APPLICATIONS SECTION. Outline 2, OUTLINES SECTION. Tube requires octal socket and may be mounted in any position. Heater volts (ac/dc), 6.3; ampere, 0.3. For maximum ratings and characteristics in converter service, refer to type 6BA7. Type 6SB7-Y is used principally for renewal purposes.

6SB7Y

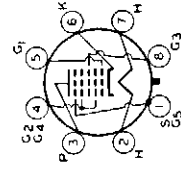

HIGH-MU TWIN TRIODE

Metal type used as phase inverter in radio equipment. Each unit may also be used in voltage-amplifier circuits. Outline 2, OUTLINES SECTION. Tube requires octal socket. Heater volts (ac/dc), 6.3; ampere, 0.3. Characteristics as class A1 amplifier (each unit): plate volts, 250 maz; grid volts, -2; amplification factor, 70; plate resistance (approx.); 53000 ohms; transconductance, 1325 μ mhos; plate ma., 2; peak heater-cathode volts, 90 maz. This type is used principally for renewal purposes.

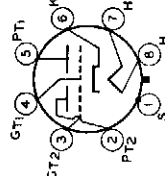

HIGH-MU TRIODE

Metal type 6SF5 and glass octal type 6SF5-GT are used in resistance-coupled amplifier circuits. Outlines 2 and 14C, respectively, OUTLINES SECTION. Type 6SF5-GT may be supplied with pin No.1 omitted. Tubes require octal socket. Characteristics, application, and references under type 6F5 apply to types 6SF5 and 6SF5-GT. Heater volts (ac/dc), 6.3; ampere, 0.3. These types are used principally for renewal purposes.

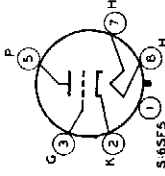

6SF5
6SF5GT
Related types:
12SF5, 12SF5GT

**DIODE—
REMOTE-CUTOFF PENTODE**

Metal type used as combined rf or amplifier and detector or avc tube in radio receivers. Also used as resistance-coupled af amplifier. Outline 2, OUTLINES SECTION. Tube requires octal socket. Heater volts (ac/dc), 6.3; amperes, 0.3. Typical operation of pentode unit as class A₁ amplifier: plate volts, 250 (300 max); grid-No.2 volts, 100 (300 max); grid-No.1 volts, -1 (0 max); plate resistance (approx.), 0.7 megohm; transconductance, 2050 μmhos; plate ma., 12.4; grid-No.2 ma., 3.3; plate dissipation, 3.5 max watts; grid-No.2 input, 0.5 max watt; peak heater-cathode volts, 90 max. For diode operation curves, refer to type 6AV6. Type 6SJ7 is used principally for renewal purposes.

6SF7

Related types:
12SF7

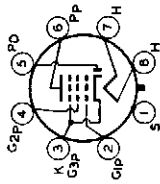

SEMIREMOTE-CUTOFF PENTODE

Metal type used as rf-amplifier tube in wide-band and high-frequency applications (up to 18 megacycles). Outline 2, OUTLINES SECTION. Tube requires octal socket. Heater volts (ac/dc), 6.3; amperes, 0.3. Characteristics as class A₁ amplifier: plate volts, 250 (300 max); grid-No.2 volts, 150 (300 max); grid-No.1 volts -2.5 (0 max); plate resistance, greater than 1 megohm; transconductance, 4000 μmhos; plate ma., 9.2; grid-No.2 ma., 3.4; plate dissipation, 3 max watts; grid-No.2 input, 0.6 max watt; peak heater-cathode volts, 90 max. This type is used principally for renewal purposes.

6SG7

Related types:
12SG7

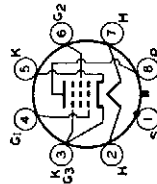

SHARP-CUTOFF PENTODE

Metal type used as rf-amplifier tube in high-frequency, wide-band applications, and as a limiter tube in FM equipment. Outline 2, OUTLINES SECTION. Tube requires octal socket. Heater volts (ac/dc), 6.3; amperes, 0.3. Characteristics as class A₁ amplifier: plate volts, 250 (300 max); grid-No.2 volts, 150 (300 max); grid-No.1 volts, -1 (0 max); plate resistance (approx.), 0.9 megohm; transconductance, 4900 μmhos; plate ma., 10.8; grid-No.2 ma., 4.1; plate dissipation, 3 max watts; grid-No.2 input, 0.7 max watt; peak heater-cathode volts, 90 max. This type is used principally for renewal purposes.

6SH7

Related types:
12SH7

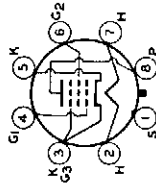

SHARP-CUTOFF PENTODE

Metal type 6SJ7 and glass octal type 6SJ7-GT used as rf amplifiers and biased detectors. As a detector, either type is capable of delivering large audio-frequency output voltage with relatively small input voltage. Outlines 2 and 14C, respectively, OUTLINES SECTION. Tubes require octal socket and may be mounted in any position. Type 6SJ7-GT is used principally for renewal purposes.

6SJ7

6SJ7GT

Related types:
12SJ7 12SJ7GT

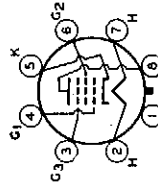

HEATER VOLTAGE (AC/DC)	6.3	volts
HEATER CURRENT	0.3	ampere
DIRECT INTERELECTRODE CAPACITANCES for 6SJ7: ^o		
Pentode Connection:		
Grid No.1 to Plate	0.005 max	pf
Grid No.1 to Cathode, Heater, Grid No.2, and Grid No.3	6.0	pf
Plate to Cathode, Heater, Grid No.2, and Grid No.3	7.0	pf
Triode Connection: ^o		
Grid No.1 to Plate	2.8	pf
Grid No.1 to Cathode and Heater	3.4	pf
Plate to Cathode and Heater	11	pf

^o With shell connected to cathode.
^o With grids No.2 and No.3 connected to plate.

CLASS A₁ AMPLIFIER

Maximum Ratings, (Design-Center Values):

PLATE VOLTAGE	250 max	Triode Connection*	250 max	Pentode Connection	300 max
GRID-No.2 (SCREEN-GRID) VOLTAGE	—	—	—	—	See curve page 70
GRID-No.2 SUPPLY VOLTAGE	—	—	—	—	300 max
GRID-No.1 (CONTROL-GRID) VOLTAGE, Positive-bias value	0 max	—	—	—	0 max
PLATE DISSIPATION	2.5 max	—	—	—	2.5 max
GRID-No.2 INPUT	—	—	—	—	0.7 max
For grid-No.2 voltages up to 150 volts	—	—	—	—	See curve page 70
For grid-No.2 voltages between 150 and 300 volts	—	—	—	—	—
PEAK HEATER-CATHODE VOLTAGE	90 max	—	—	—	90 max
Heater negative with respect to cathode	90 max	—	—	—	90 max
Heater positive with respect to cathode	—	—	—	—	—

Typical Operation:

Plate Voltage	180	Triode Connection*	250	Connected to cathode at socket	250
Grid No.3	—	—	—	—	100
Grid-No.2 Voltage	—	—	—	—	100
Grid-No.1 Voltage	-6	—	-8.5	—	-3
Amplification Factor	19	—	19	—	—
Plate Resistance (Approx.)	8250	—	7600	—	—
Transconductance	2300	—	2500	—	1650
Grid-No.1 Voltage (Approx.) for plate current of 10 μa	—	—	—	—	—
Plate Current	6.0	—	9.2	—	-8
Grid-No.2 Current	—	—	—	—	3.0
	—	—	—	—	0.9

* Grids No.2 and No.3 connected to plate. † Greater than 1 megohm.

REMOTE-CUTOFF PENTODE

Metal type 6SK7 and glass octal type 6SK7-GT used as rf or if amplifiers in radio receivers. Outlines 2 and 14C, respectively, OUTLINES SECTION. Tubes require octal socket. Heater volts (ac/dc), 6.3; amperes, 0.3. Characteristics as class A₁ amplifier: plate volts, 250 (300 max); grid-No.3 connected to cathode at socket; grid-No.2 volts, 100 (300 max); grid-No.1 volts, -3 (0 max); plate resistance (approx.), 0.8 megohm; transconductance, 2000 μmhos; plate ma., 9.2; grid-No.2 ma., 2.6; plate dissipation, 4 max watts; grid-No.2 input, 0.4 max watt; peak heater-cathode volts, 90 max. These types are used principally for renewal purposes.

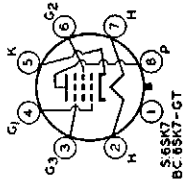

6SK7
6SK7GT

Related types:
12SK7, 12SK7GT

HIGH-MU TWIN TRIODE

Glass octal type used as phase inverter in radio equipment. Each unit may also be used in resistance-coupled amplifier circuits. Outline 14C, OUTLINES SECTION. Tube requires octal socket and may be mounted in any position. Except for the common heater, each triode unit is independent of the other. For typical operation as phase inverter or resistance-coupled amplifier, refer to RESISTANCE-COUPLED AMPLIFIER SECTION.

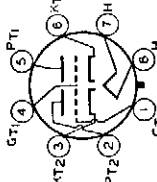

6SL7GT

Related type:
12SL7GT

HEATER VOLTAGE (AC/DC)	6.3	volts
HEATER CURRENT	0.3	ampere
DIRECT INTERELECTRODE CAPACITANCES (Approx.): ^o		
Grid to Plate	2.8	Unit No. 1
Grid to Cathode and Heater	3.0	Unit No. 2
Plate to Cathode and Heater	3.8	3.4
		3.2

CLASS A₁ AMPLIFIER (Each Unit)

Maximum Ratings, (Design-Center Values):		
PLATE VOLTAGE	300 max	volts
GRID VOLTAGE, Positive-bias value	0 max	volts
PLATE DISSIPATION	1 max	watt
PEAK HEATER-CATHODE VOLTAGE	90 max	volts
Heater negative with respect to cathode	90 max	volts
Heater positive with respect to cathode	90 max	volts

Plate Current.....	10	9	ma
Plate Current for grid voltage of -12.5 volts.....	10	1.3	ma
Grid Voltage (Approx.) for plate current of 10 ma.....	-7	-18	volts
Maximum Circuit Value:			
Grid-Circuit Resistance.....	1.0 max		megohm
For fixed-bias operation.....			
*The dc component must not exceed 100 volts.			

OSCILLATOR (Each Unit)
For operation in a 525-line, 30-frame system

Vertical		Horizontal	
Deflection Oscillator		Deflection Oscillator	
DC PLATE VOLTAGE.....	450 max	450 max	volts
PEAK NEGATIVE-PULSE GRID VOLTAGE.....	-400 max	-600 max	volts
PEAK CATHODE CURRENT.....	70 max	300 max	ma
AVERAGE CATHODE CURRENT.....	20 max	200 max	ma
PLATE DISSIPATION:			
For either plate.....	5 max	5 max	watts
For both plates with both units operating.....	7.5 max	7.5 max	watts
PEAK HEATER-CATHODE VOLTAGE.....	200 max	200 max	volts
Heater negative with respect to cathode.....	200° max	200° max	volts
Heater positive with respect to cathode.....			
Maximum Circuit Value:			
Grid-Circuit Resistance.....	2.2 max	2.2 max	megohm

VERTICAL DEFLECTION AMPLIFIER (Each Unit)
For operation in a 525-line, 30-frame system

Maximum Ratings, (Design-Center Values):		6SN7-GTB	
DC PLATE VOLTAGE.....	450 max	450 max	volts
PEAK POSITIVE-PULSE PLATE VOLTAGE* (Absolute maximum).....	1500 max	1500 max	volts
PEAK NEGATIVE-PULSE GRID VOLTAGE.....	-250 max	-250 max	volts
PEAK CATHODE CURRENT.....	70 max	70 max	ma
AVERAGE CATHODE CURRENT.....	20 max	20 max	ma
PLATE DISSIPATION:			
For either plate.....	5 max	5 max	watts
For both plates with both units operating.....	7.5 max	7.5 max	watts
PEAK HEATER-CATHODE VOLTAGE.....	200 max	200 max	volts
Heater negative with respect to cathode.....	200° max	200° max	volts
Heater positive with respect to cathode.....			
Maximum Circuit Value:			
Grid-Circuit Resistance.....	2.2 max	2.2 max	megohms
For cathode-bias operation.....			
*The duration of the voltage pulse must not exceed 15 per cent of one vertical scanning cycle. In a 525-line, 30-frame system, 15 per cent of one vertical scanning cycle is 2.5 milliseconds.			
‡ Under no circumstances should this absolute value be exceeded.			
° The dc component must not exceed 100 volts.			

6SQ7
6SQ7GT
Related types:
12SQ7, 12SQ7GT

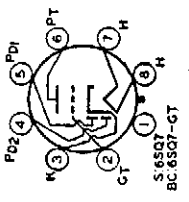

TWIN DIODE—HIGH-MU TRIODE
Metal type 6SQ7 and glass octal type 6SQ7-GT used as combined detector, amplifier, and avc tube in radio receivers. Outlines 2 and 14C, respectively, **OUTLINES SECTION**. Tubes require octal socket and may be mounted in any position. These types are similar electrically to type 6Q7 in many respects, but they have a higher-mu triode. Diode-biasing of the triode unit is not suitable because of the probability of triode plate-current cutoff even with relatively small signal voltages applied to the diode circuit. Type 6SQ7-GT is used principally for renewal purposes.

HEATER VOLTAGE (AC/DC).....	6.3	volts
HEATER CURRENT.....	0.3	ampere
DIRECT INTERELECTRODE CAPACITANCES for 6SQ7:°		
Triode Unit:		
Grid to Plate.....	1.6	pf
Grid to Cathode and Heater.....	3.2	pf
Plate to Cathode and Heater.....	3	pf

Characteristics:	
Plate Voltage.....	250
Grid Voltage.....	-2
Amplification Factor.....	40
Plate Resistance (Approx.).....	44,000
Transconductance.....	1600
Plate Current.....	2.3

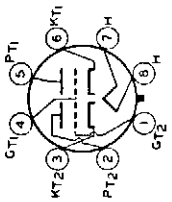

6SN7GT
6SN7GTA
Related types:
12SN7GT, 12SN7GTA

MEDIUM-MU TWIN TRIODE
Glass octal types used as combined vertical oscillators and vertical deflection amplifiers, and as horizontal deflection oscillators, in television receivers. Each unit may also be used in multivibrator or resistance-coupled amplifier circuits in radio equipment. Type 6SN7-GTB has a controlled heater warm-up time to permit use in series-connected heater strings. Outline 14C, **OUTLINES SECTION**. Tubes require octal socket and may be mounted in any position. Except for the common heater, each triode unit is independent of the other. For typical operation as resistance-coupled amplifier, refer to **RESISTANCE-COUPLED AMPLIFIER SECTION**. Types 6SN7-GT and 6SN7-GTA are **DISCONTINUED** types listed for reference only.

HEATER VOLTAGE (AC/DC).....	6.3	volts
HEATER CURRENT.....	0.6	ampere
HEATER WARM-UP TIME (Average) for 6SN7-GTB.....	11	seconds
DIRECT INTERELECTRODE CAPACITANCES (Approx.) for 6SN7-GTB:		
Grid to Plate.....	4.0	Unit N _v /1
Grid to Cathode and Heater.....	2.2	Unit N _v /2
Plate to Cathode and Heater.....	0.7	Unit N _v /2

CLASS A₁ AMPLIFIER (Each Unit)

Maximum Ratings, (Design-Center Values):		6SN7-GTB	
PLATE VOLTAGE.....	450 max	450 max	volts
CATHODE CURRENT.....	20 max	20 max	ma
PLATE DISSIPATION:			
For either plate.....	5 max	5 max	watts
For both plates with both units operating.....	7.5 max	7.5 max	watts
PEAK HEATER-CATHODE VOLTAGE.....	200 max	200 max	volts
Heater negative with respect to cathode.....	200° max	200° max	volts
Heater positive with respect to cathode.....			
Characteristics:			
Plate Voltage.....	90	250	volts
Grid Voltage.....	0	-8	volts
Amplification Factor.....	20	20	
Plate Resistance (Approx.).....	6700	7700	ohms
Transconductance.....	3000	2600	μmhos

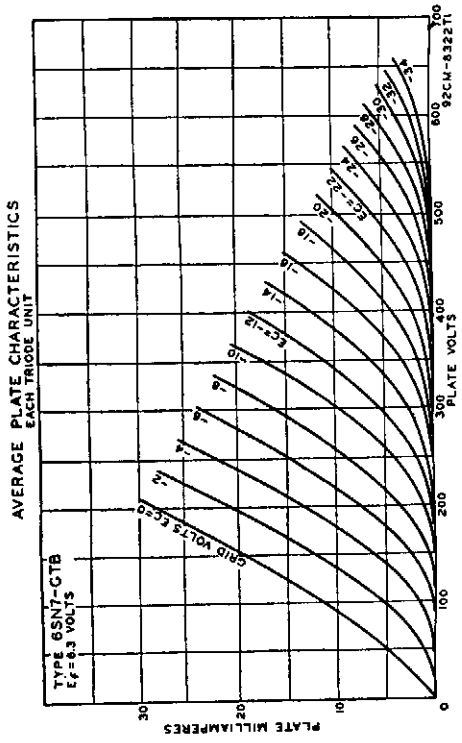

Either Diode Plate to Cathode and Heater.
 Triode Grid to Plate of Diode No. 1.
 Triode Grid to Plate of Diode No. 2.
 * With shell connected to cathode.

TRIODE UNIT AS CLASS A₁ AMPLIFIER

Maximum Ratings, (Design-Center Values):

PLATE VOLTAGE	300 maz	pf
GRID VOLTAGE, Positive-bias value	0 maz	pf
PLATE DISSIPATION	0.5 maz	pf
PEAK HEATER-CATHODE VOLTAGE	90 maz	volts
Heater negative with respect to cathode	90 maz	volts
Heater positive with respect to cathode	90 maz	volts
Characteristics:		
Plate Voltage	250	volts
Grid Voltage	-2	volts
Amplification Factor	100	
Plate Resistance (Approx.)	110000	ohms
Transconductance	925	μmhos
Plate Current	0.5	ma

DIODE UNITS

Maximum Rating, (Design-Center Value):
 PLATE CURRENT (Each Unit) 1.0 maz
 Two diode plates are placed around a cathode, the sleeve of which is common to the triode unit. Each diode plate has its own base pin. For diode operation curves, refer to type 6AV6.

TWIN DIODE—MEDIUM-MU TRIODE

Metal type used as combined detector, amplifier, and avc tube. It is equivalent in performance to miniature type 6BF6. Outline 2, OUTLINES SECTION. Tube requires octal socket and may be mounted in any position. Heater volts (ac/dc), 6.3; ampere, 0.3. Maximum ratings and typical operation of triode unit as class A₁ amplifier: plate volts, 250 maz; grid volts, -9; amplification factor, 16; plate resistance (approx.), 8500 ohms; transconductance, 1900 μmhos; plate ma., 9.5; plate dissipation, 2.5 maz watts; peak heater-cathode volts, 90 maz. For diode-operation curves, refer to type 6AV6. Type 6SR7 is used principally for renewal purposes.

6SR7

Related type: 12SR7

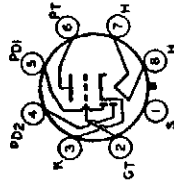

REMOTE-CUTOFF PENTODE

Metal type used in rf or if stages of radio receivers particularly those employing avc. Outline 2, OUTLINES SECTION. Tube requires octal socket and may be mounted in any position. Heater volts (ac/dc), 6.3; ampere, 0.15. Typical operation as class A₁ amplifier: plate volts, 250 (300 maz); grid-No.2 supply volts, 300 maz; grid-No.2 volts, 100; grid-No.1 volts, -3; grid No.3 connected to cathode at socket; 1 megohm; transconductance, 1850 μmhos; plate ma., 9; grid-No.2 ma., 2; plate resistance, 2.25 maz watts; grid-No.2 input, 0.35 maz watts. Type 6SS7 is used principally for renewal purposes.

6SS7

TWIN DIODE—MEDIUM-MU TRIODE

Metal type used as combined detector, amplifier, and avc tube. Within maximum ratings this type is electrically identical to type 6BF6 except for interelectrode capacitances and heater current. Outline 2, OUTLINES SECTION. Tube requires octal socket and may be mounted in any position. Heater volts (ac/dc), 6.3; ampere, 0.15. Maximum ratings of triode unit as class A₁ amplifier: plate volts, 250 maz; plate dissipation, 2.5 maz watts. For diode operation curves, refer to type 6AV6. Type 6ST7 is a DISCONTINUED type listed for reference only.

6ST7

TWIN DIODE—HIGH-MU TRIODE

Metal type used as combined detector, amplifier, and avc tube in radio receivers. Except for heater-current rating and interelectrode capacitances, this type is essentially the same electrically as type 6AT6. Outline 2, OUTLINES SECTION. Tube requires octal socket. Heater volts (ac/dc), 6.3; ampere, 0.15. For diode operation curves, refer to type 6AV6. Type 6SZ7 is a DISCONTINUED type listed for reference only.

6SZ7

MEDIUM-MU TRIODE

Miniature type used as oscillator in tuners of ubi television receivers. Outline 7A, OUTLINES SECTION. Tube requires miniature seven-contact socket. Heater volts (ac/dc), 6.3; ampere, 0.225. Characteristics as class A₁ amplifier: plate-supply volts, 80; cathode-bias resistor, 150 ohms; plate ma., 18; amplification factor, 13; transconductance, 7000 μmhos. Maximum ratings as oscillator in ubi television receivers: plate volts, 8 maz; cathode ma., 30 maz; plate dissipation, 3.5 maz watts; peak heater-cathode volts, 50 maz. This type is used principally for renewal purposes.

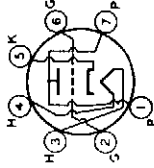

6T4

TWIN DIODE—HIGH-MU TRIODE

Glass octal type used as combined detector, amplifier, and avc tube in radio receivers. Outline 23, OUTLINES SECTION. Heater volts (ac/dc), 6.3; ampere, 0.15. Typical operation as class A₁ amplifier: plate volts, 250 maz; grid volts, -3; plate ma., 1.2; plate resistance (approx.), 62000 ohms; amplification factor, 65; transconductance, 1050 μmhos. For diode operation curves, refer to type 6AV6. Type 6T7-G is a DISCONTINUED type listed for reference only.

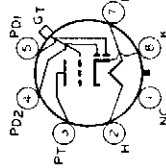

6T7G

TRIPLE DIODE—HIGH-MU TRIODE

Miniature types used as combined audio amplifier, AM detector, and FM detector in AM/FM radio receivers. Diode unit No.1 is used for AM detection, and diode units No.2 and No.3 are used for FM detection. Type 6T8-A has a controlled heater warm-up time for use in receivers employing series-connected heater strings. Outline 8B, OUTLINES SECTION. Tubes require miniature nine-contact socket and may be mounted in any position. For typical operation as resistance-coupled amplifier, refer to RESISTANCE-COUPLED AMPLIFIER SECTION. Type 6T8 is a DISCONTINUED type listed for reference only.

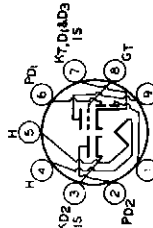

6T8

6T8A

Related types: 5T8, 19T8

HEATER VOLTAGE (AC/DC)	6.3	volts
HEATER CURRENT	0.45	ampere
HEATER WARM-UP TIME (Average) for 6T8-A	11	seconds
DIRECT INTERELECTRODE CAPACITANCES for 6T8-A:		
Triode Unit:		
Grid to Plate	Without Shield	1.7
Grid to Cathode, Internal Shield (pin 7), and Heater	External Shield	1.6
Plate to Cathode, Internal Shield (pin 7), and Heater	Without Shield	1.2
Diode Units:		
Diode-No.1 Plate to Cathode, Internal Shield (pin 7), and Heater	3.8	pf
Diode-No.2 Plate to Cathode, Internal Shield (pin 3), and Heater	3.8	pf
Diode-No.3 Plate to Cathode, Internal Shield (pin 7), and Heater	3.4	pf
Diode-No.2 Cathode, Internal Shield (pin 3) to All Other Electrodes, and Heater	7.5	pf
Triode Grid to any Diode Plate	0.034 maz	0.034 maz
* With external shield connected to pin 7 except as noted.		
■ With external shield connected to pin 3.		
■ With external shield connected to pins 4 and 5.		

TRIODE UNIT AS CLASS A₁ AMPLIFIER

Maximum Ratings, (Design-Maximum Values):

PLATE VOLTAGE	380 maz	volts
GRID VOLTAGE, Positive-bias value	0 maz	volts
PLATE DISSIPATION	1.1 maz	watts
PEAK HEATER-CATHODE VOLTAGE	100 maz	volts
Heater negative with respect to cathode	100 maz	volts
Heater positive with respect to cathode	100 maz	volts

Characteristics:

Plate Voltage.....	100	250	volts
Grid Voltage.....	-1	-3	volts
Amplification Factor.....	70	70	ohms
Plate Resistance (Approx.).....	54000	58000	μmhos
Transconductance.....	1300	1200	ma
Plate Current.....	0.8	1.0	ma

DIODE UNITS

Maximum Ratings, (Design-Maximum Values):	
PLATE CURRENT (Each Unit).....	5.5 maz
PEAK HEATER-CATHODE VOLTAGE (Unit No.2):	100 maz
Heater negative with respect to cathode.....	100 maz
Heater positive with respect to cathode.....	

AVERAGE PLATE CHARACTERISTICS
TRIODE UNIT

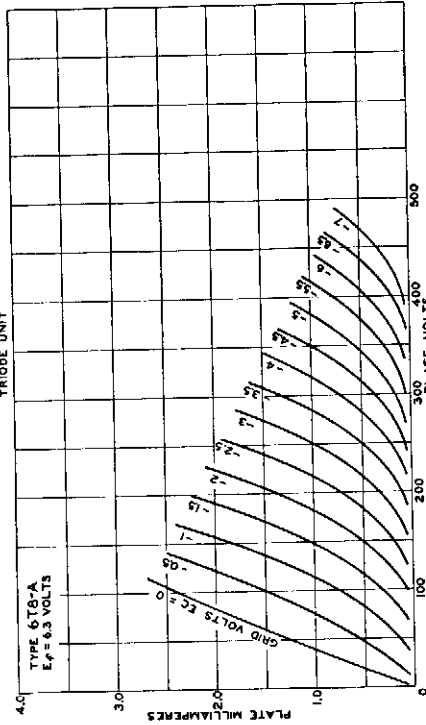

92CM-70A3T

ELECTRON-RAY TUBE

Glass type used to indicate visually, by means of a fluorescent target, the effects of a change in a controlling voltage. It is used as a convenient, non-mechanical means of indicating accurate radio-receiver tuning. Maximum dimensions: over-all length, 4-3/16 inches; height, 3-9/16 inches; diameter, 1-3/16 inches. Tube requires six-contact socket. For a discussion of electron-ray tube considerations, refer to operation in indicator service: plate- and target-supply volts, 250 (285 maz); target-supply volts, 125 maz; series triode-plate resistor, 1 megohm; target ma., 4; triode-plate ma., 0.24; triode-plate dissipation, 1 maz watt; triode-grid volts (approx.), -22 for 0° shadow angle, 0 for 90° shadow angle; peak heater-cathode volts, 90 maz. This type is used principally for renewal purposes.

6U5

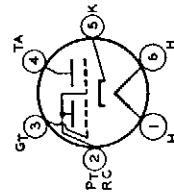

ELECTRON TUBE APPLICATIONS SECTION. Heater volts (ac/dc), 6.3; amperes, 0.3. Typical operation in indicator service: plate- and target-supply volts, 250 (285 maz); target-supply volts, 125 maz; series triode-plate resistor, 1 megohm; target ma., 4; triode-plate ma., 0.24; triode-plate dissipation, 1 maz watt; triode-grid volts (approx.), -22 for 0° shadow angle, 0 for 90° shadow angle; peak heater-cathode volts, 90 maz. This type is used principally for renewal purposes.

REMOTE-CUTOFF PENTODE

Glass octal type used in rf and if stages of radio receivers employing avc. It is also used as a mixer in superheterodyne circuits. Maximum over-all length, 4-7/8 inches; maximum diameter, 1-9/16 inches. Tube requires octal socket. Heater volts (ac/dc), 6.3; amperes, 0.3. Typical operation as class A₁ amplifier: plate volts, 250 (300 maz); grid-No.2 supply volts, 300 maz; grid-No.2 volts, 100; grid No.3 connected to cathode at socket; grid-No.1 volts, -3; plate resistance (approx.), 0.8 megohm; transconductance, 1600 μmhos; plate ma., 6.2; grid-No.2 ma., 2.25 maz watts; plate dissipation, 2.25 maz watts; grid-No.2 input 0.25 maz watt. This is a DISCONTINUED type listed for reference only.

6U7G

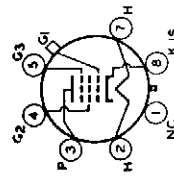

MEDIUM-MU TRIODE—
SHARP-CUTOFF PENTODE

Miniature types used as combined oscillator and mixer tubes in television receivers utilizing an intermediate frequency in the order of 40 megacycles per second. Type 6U8-A has a controlled heater warm-up time for use in television receivers employing series-connected heater strings. Outline 8B, OUTLINES SECTION. Tubes require miniature nine-contact socket and may be mounted in any position. Type 6U8 is a DISCONTINUED type listed for reference only.

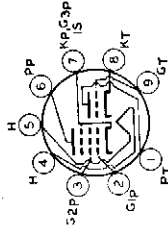

6U8
6U8A
Related types:
5U8, 9U8A

HEATER VOLTAGE (AC/DC).....	6.3	volts
HEATER CURRENT.....	0.45	ampere
HEATER WARM-UP TIME (Average) for 6U8-A.....	11	seconds

DIRECT INTERELECTRODE CAPACITANCES:		
Triode Unit:		Without External Shield*
Grid to Plate.....	1.8	pf
Grid to Cathode, Heater, Pentode Cathode, Pentode Grid No.3, and Internal Shield.....	2.8	pf
Plate to Cathode, Heater, Pentode Cathode, Pentode Grid No.3, and Internal Shield.....	1.5	pf

Pentode Unit:		
Grid No.1 to Plate.....	0.010 maz	0.006 maz
Grid No.1 to Cathode, Heater, Grid No.2, Grid No.3, and Internal Shield.....	5.0	5.0
Plate to Cathode, Heater, Grid No.2, Grid No.3, and Internal Shield.....	2.6	3.5
Triode Cathode to Heater.....	3	3
Pentode Cathode, Pentode Grid No.3, and Internal Shield to Heater.....	3	3
Pentode Grid No.1 to Triode Plate.....	0.2 maz	0.2 maz
Pentode Plate to Triode Plate.....	0.1 maz	0.02 maz

* With external shield connected to pin 4 except as noted.
• With external shield connected to pin 6.

CLASS A₁ AMPLIFIER

Maximum Ratings, (Design-Maximum Values):

PLATE VOLTAGE.....	Triode Unit	Pentode Unit
GRID-No.2 (SCREEN-GRID) SUPPLY VOLTAGE.....	330 maz	330 maz
GRID-No.2 VOLTAGE.....	0	See curve page 70
GRID-No.1 (CONTROL-GRID) VOLTAGE, Positive-bias value.....	0 maz	0 maz
PLATE DISSIPATION.....	2.5 maz	3 maz
GRID-No.2 INPUT:		
For grid-No.2 voltages up to 165 volts.....	—	0.55 maz
For grid-No.2 voltages between 165 and 330 volts.....	—	See curve page 70
PEAK HEATER-CATHODE VOLTAGE:		
Heater negative with respect to cathode.....	200 maz	200 maz
Heater positive with respect to cathode.....	280 maz	280 maz

Characteristics:

Plate Voltage.....	Triode Unit	Pentode Unit
Grid-No.2 Voltage.....	125	125
Grid-No.1 Voltage.....	—	110
Amplification Factor.....	40	—
Plate Resistance (Approx.).....	—	5000
Transconductance.....	7500	5000
Grid-No.1 Voltage (Approx.) for plate current of 20 μa.....	—	—
Plate Current.....	13.5	9.5
Grid-No.2 Current.....	—	3.5

* The dc component must not exceed 100 volts.

6V3A

HALF-WAVE VACUUM RECTIFIER

Miniature type used as a damper tube in horizontal deflection circuits of television receivers. Outline 9B, OUTLINES SECTION, except vertical dimensions are 7/32 inch shorter than shown. Tube requires miniature nine-contact socket and may be mounted in any position. It is especially important that this tube, like other power-handling tubes, be adequately ventilated. Heater volts (ac/dc), 6.3; amperes, 1.75.

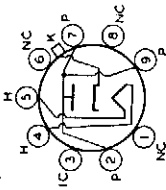

than shown. Tube requires miniature nine-contact socket and may be mounted in any position. It is especially important that this tube, like other power-handling tubes, be adequately ventilated. Heater volts (ac/dc), 6.3; amperes, 1.75.

DAMPER SERVICE

For operation in a 525-line, 30-frame system

Maximum Ratings, (Design-Center Values):	
PEAK INVERSE PLATE VOLTAGE# (Absolute Maximum)	6000 [†] max volts
DC PLATE CURRENT	800 max ma
DC PLATE CURRENT	135 max ma
PEAK HEATER-CATHODE VOLTAGE:	
Heater negative with respect to cathode# (Absolute Maximum)	6750 [†] max volts
Heater positive with respect to cathode	300 [‡] max volts

#The duration of the voltage pulse must not exceed 15 per cent of one horizontal scanning cycle. In a 525-line, 30-frame system, 15 per cent of one horizontal scanning cycle is 10 microseconds.

† Under no circumstances should this absolute value be exceeded.
 ‡ The dc component must not exceed 750 volts.
 ° The dc component must not exceed 100 volts.

6V6 BEAM POWER TUBE

Metal type 6V6 and glass octal types 6V6-GT and 6V6-GTA are used as output amplifiers in automobile, battery-operated, and other receivers in which reduced plate-current drain is desirable. Outlines 5, 14C, and 14C, respectively, OUTLINES SECTION. Type 6V6-GT may be supplied with pin No.1 omitted. Tubes require octal socket and may be mounted in any position. These tubes are equivalent in performance to type 6AQ5-A. Refer to type 6AQ5-A for average plate characteristic curves. Type 6V6-GT is a DISCONTINUED type listed for reference only.

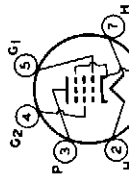

HEATER VOLTAGE (AC/DC)	6.3 volts
HEATER CURRENT	0.45 ampere
HEATER WARM-UP TIME (Average) 6V6-GTA	11 seconds
DIRECT INTERELECTRODE CAPACITANCES (Approx.):	
Grid No.1 to Plate	6 V [°] 0.8 pf
Grid No.1 to Cathode, Heater, Grid No.2, and Grid No.3	10 pf
Plate to Cathode, Heater, Grid No.2, and Grid No.3	11 pf

° With shell connected to cathode.

Maximum Ratings, (Design-Maximum Values):	
PLATE VOLTAGE	350 max volts
GRID-NO.2 (SCREEN-GRID) VOLTAGE	315 max volts
PLATE DISSIPATION	14 max watts
GRID-NO.2 DISSIPATION	2.2 max watts
PEAK HEATER-CATHODE VOLTAGE:	
Heater negative with respect to cathode	6750 [†] max volts
Heater positive with respect to cathode	200 [‡] max volts

† Under no circumstances should this absolute value be exceeded.
 ‡ The dc component must not exceed 750 volts.
 ° The dc component must not exceed 100 volts.

CLASS A₁ AMPLIFIER

For operation in a 525-line, 30-frame system

Maximum Ratings, (Design-Maximum Values):	
Plate Voltage	180 volts
Grid No.2 Voltage	180 volts
Grid No.1 (Control-Grid) Voltage	-8.5 volts
Peak AF Grid-No.1 Voltage	8.5 volts
Zero-Signal Plate Current	29 ma
Maximum-Signal Plate Current	30 ma
Zero-Signal Grid-No.2 Current	3 ma
Maximum-Signal Grid-No.2 Current	4 ma
Plate Resistance (Approx.)	50000 ohms
Transconductance	3700 μmhos
Total Resistance	5500 ohms
Total Harmonic Distortion	8 per cent
Maximum-Signal Power Output	2 watts

#The duration of the voltage pulse must not exceed 15 per cent of one vertical scanning cycle. In a 525-line, 30-frame system, 15 per cent of one vertical scanning cycle is 2.5 milliseconds.

† Under no circumstances should this absolute value be exceeded.
 ‡ The dc component must not exceed 100 volts.

° The dc component must not exceed 100 volts.

° The dc component must not exceed 100 volts.

Characteristics (Triode Connection):*

Plate Voltage	250 volts
Grid-No.1 (Control-Grid) Voltage	-12.5 volts
Amplification Factor	9.8
Plate Resistance (Approx.)	1360 ohms
Transconductance	5000 μmhos
Plate Current	49.5 ma
Grid-No.1 Voltage (Approx.) for plate current of 0.5 ma	-36 volts

PUSH-PULL CLASS A₁ AMPLIFIER

Maximum Ratings: (Same as for class A₁ amplifier)

Typical Operation (Values are for two tubes):	
Plate Voltage	250 volts
Grid-No.2 Voltage	250 volts
Grid-No.1 (Control-Grid) Voltage	-15 volts
Peak AF Grid-No.1-to-Grid-No.1 Voltage	30 volts
Zero-Signal Plate Current	70 ma
Maximum-Signal Plate Current	79 ma
Zero-Signal Grid-No.2 Current	6 ma
Maximum-Signal Grid-No.2 Current	13 ma
Effective Load Resistance (Plate-to-Plate)	10000 ohms
Total Harmonic Distortion	5 per cent
Maximum-Signal Power Output	10 watts

Maximum Circuit Values:

Grid-No.1-Circuit Resistance:	0.1 maz
For fixed-bias operation:	0.5 maz
For cathode-bias operation:	megohm

VERTICAL DEFLECTION AMPLIFIER (Triode Connection)*

For operation in a 525-line, 30-frame system

Maximum Ratings, (Design-Maximum Values):

DC PLATE VOLTAGE	350 volts
PEAK POSITIVE-PULSE PLATE VOLTAGE†	1200 volts
PEAK NEGATIVE-PULSE GRID-NO.1 (CONTROL-GRID) VOLTAGE	275 volts
PEAK CATHODE CURRENT	115 ma
AVERAGE CATHODE CURRENT	40 ma
PLATE DISSIPATION	10 maz watts
PEAK HEATER-CATHODE VOLTAGE:	
Heater negative with respect to cathode	200 maz volts
Heater positive with respect to cathode	200 [‡] maz volts

Maximum Circuit Value:

Grid-No.1-Circuit Resistance:	2.2 maz megohms
For cathode-bias operation:	
▲ Grid No.2 connected to plate.	

#The duration of the voltage pulse must not exceed 15 per cent of one vertical scanning cycle. In a 525-line, 30-frame system, 15 per cent of one vertical scanning cycle is 2.5 milliseconds.
 † The dc component must not exceed 100 volts.

TWIN DIODE—LOW-MU TRIODE

Glass octal type used as combined detector, amplifier, and avc tube. Outline 23, OUTLINES SECTION. Except for interelectrode capacitances, this type is identical electrically with type 85. Heater volts (ac/dc), 6.3; amperes, 0.3. For diode operation curves, refer to type 6AV6. Type 6V7-G is a DISCONTINUED type listed for reference only.

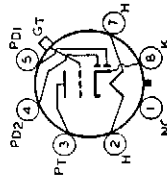

HALF-WAVE VACUUM RECTIFIER

Glass octal type used as damper tube in television receivers. Outline 14C, OUTLINES SECTION. This type may be supplied with pin No.1 omitted. Tube requires octal socket and may be mounted in any position. Socket terminals 1, 2, 4, and 6 should not be used as tie points. It is especially important that this tube, like other power-handling tubes, be adequately ventilated. Power-rectifier operation of this type is not recommended.

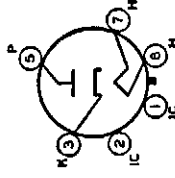

be mounted in any position. Socket terminals 1, 2, 4, and 6 should not be used as tie points. It is especially important that this tube, like other power-handling tubes, be adequately ventilated. Power-rectifier operation of this type is not recommended.

HEATER VOLTAGE (AC).....	6.3	volts
HEATER CURRENT.....	1.2	amperes
DIRECT INTERELECTRODE CAPACITANCES (Approx.):		
Plate to Cathode and Heater.....	6	pf
Cathode to Plate and Heater.....	13	pf
Heater to Cathode.....	7	pf

DAMPER

For operation in a 525-line, 30-frame system

Maximum Ratings, (Design-Center Values):		
PEAK INVERSE PLATE VOLTAGE (Absolute Maximum)*.....	3850	max
PEAK PLATE CURRENT.....	750	max
DC PLATE CURRENT.....	125	max
DC PLATE DISSIPATION.....	3.5	watts
PEAK HEATER-CATHODE VOLTAGE:		
Heater negative with respect to cathode (Absolute Maximum)*.....	2300	max
Heater positive with respect to cathode.....	300	max

Characteristics, Instantaneous Value:

Tube Voltage Drop for plate current of 250 ma
 * The duration of the voltage pulse must not exceed 15 per cent of one horizontal scanning cycle. In a 525-line, 30-frame system, 15 per cent of one horizontal scanning cycle is 10 microseconds.
 † The dc component must not exceed 500 volts.
 ‡ The dc component must not exceed 100 volts.

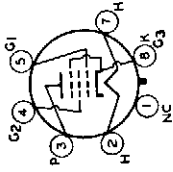

BEAM POWER TUBE

Glass octal type used in the audio output stage of radio and television receivers. Triode-connected, it is used as a vertical deflection amplifier in television receivers. Outline 14C, OUT-LINES SECTION. This type may be supplied with pin No.1 omitted. Tube requires octal socket and may be mounted in any position.

6W6GT
 Related type:
 12W6GT

HEATER VOLTAGE (AC/DC).....	6.3	volts
HEATER CURRENT.....	1.2	amperes
DIRECT INTERELECTRODE CAPACITANCES (Approx.):		
Grid No.1 to Plate.....	0.8	pf
Grid No.1 to Cathode, Heater, Grid No.2, and Grid No.3.....	15	pf
Plate to Cathode, Heater, Grid No.2, and Grid No.3.....	9	pf

CLASS A₁ AMPLIFIER

Maximum Ratings, (Design-Maximum Values):		
PLATE VOLTAGE.....	330	max
GRID-NO.2 (SCREEN-GRID) VOLTAGE.....	165	max
PLATE DISSIPATION.....	1.2	watts
GRID-NO.2 INPUT.....	1.35	max
PEAK HEATER-CATHODE VOLTAGE:		
Heater negative with respect to cathode.....	200	max
Heater positive with respect to cathode.....	200	max

AVERAGE PLATE CHARACTERISTICS

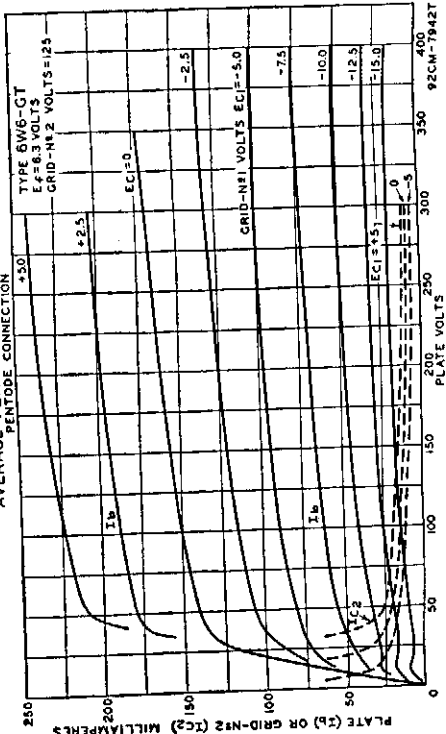

Typical Operation:		
Plate Supply Voltage.....	200	volts
Grid-No.2 Supply Voltage.....	125	volts
Grid-No.1 (Control-Grid) Voltage.....	-7.5	volts
Cathode-Bias Resistor.....	180	ohms
Peak AF Grid-No.1 Voltage.....	8.5	volts
Zero-Signal Plate Current.....	48	ma
Maximum-Signal Plate Current.....	47	ma
Zero-Signal Grid-No.2 Current.....	2.2	ma
Maximum-Signal Grid-No.2 Current.....	8.5	ma
Plate Resistance (Approx.).....	13000	ohms
Transconductance.....	8000	μmhos
Load Resistance.....	2000	ohms
Total Harmonic Distortion (Approx.).....	10	per cent
Maximum-Signal Power Output.....	2.1	watts

Characteristics (Triode Connection)*:

Plate Voltage.....	225	volts
Grid-No.1 Voltage.....	-30	volts
Amplification Factor.....	6.2	
Plate Resistance (Approx.).....	1600	ohms
Transconductance.....	3800	μmhos
Plate Current.....	22	ma
Grid No.1 Voltage (Approx.) for plate current of 0.5 ma.....	-42	volts

*Grid No. 2 connected to plate.

Maximum Circuit Values:

Grid-No.1 Circuit Resistance:	0.1	max
For fixed-bias operation.....	0.5	max
For cathode-bias operation.....		

VERTICAL DEFLECTION AMPLIFIER

For operation in a 525-line, 30-frame system

Maximum Ratings, (Design-Maximum Values):		
DC PLATE VOLTAGE.....	330	max
PEAK POSITIVE-PULSE PLATE VOLTAGE.....	1200	max
DC GRID NO.2 (SCREEN-GRID) VOLTAGE.....	-275	max
PEAK NEGATIVE-PULSE GRID-NO.1 VOLTAGE.....	185	max
PEAK CATHODE CURRENT.....	65	max
AVERAGE CATHODE CURRENT.....	8.5	max
PLATE DISSIPATION.....	—	
GRID-NO.2 INPUT.....	—	
PEAK HEATER-CATHODE VOLTAGE:		
Heater negative with respect to cathode.....	200	max
Heater positive with respect to cathode.....	200	max

Maximum Circuit Value:

Grid-No.1-Circuit Resistance:	2.2	max
For cathode-bias operation.....	2.2	max

* Grid No.2 connected to plate.
 † The duration of the voltage pulse must not exceed 15 per cent of one vertical scanning cycle. In a 525-line, 30-frame system, 15 per cent of one vertical scanning cycle is 2.5 milliseconds.
 ‡ The dc component must not exceed 100 volts.

AVERAGE PLATE CHARACTERISTICS

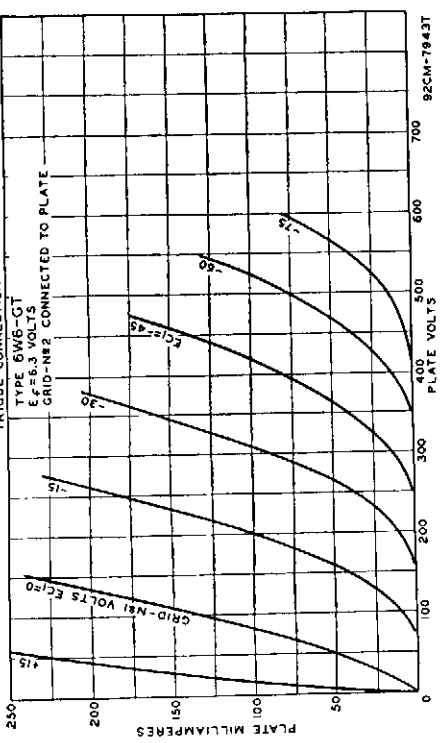

SHARP-CUTOFF PENTODE

Glass octal type used as biased detector or high-gain amplifier in radio receivers. Outline 23, OUTLINES SECTION. Tube requires octal socket. Heater volts (ac/dc), 6.3; amperes, 0.15. Maximum ratings: plate volts, 300 *max*; grid-No.2 (screen-grid) volts, 100 *max*; grid-No.2 supply volts, 300 *max*; grid-No.1 control-grid) volts, 0 *max*; plate dissipation, 0.5 *max* watt; grid-No.3 input, 0.1 *max* watt. Within its maximum ratings, this type is identical electrically with type 6J7. Type 6W7-G is a DISCONTINUED type listed for reference only.

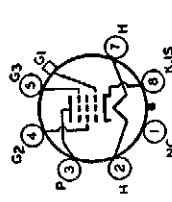

6W7G

FULL-WAVE VACUUM RECTIFIER

Miniature type used in power supply of automobile and ac-operated radio receivers. Equivalent in performance to larger types 6X5 and 6X5-GT. Type 6X4 requires miniature seven-contact socket and may be mounted in any position. Outline 7C, OUTLINES SECTION. It is especially important that this tube, like other power-handling tubes, be adequately ventilated. For discussion of Rating Chart and Operation Characteristics, refer to INTERPRETATION OF TUBE DATA. Heater volts (ac/dc), 6.3; amperes, 0.6.

6X4

Related types
12X4

FULL-WAVE RECTIFIER

Maximum Ratings, (Design-Maximum Values):
 PEAK INVERSE PLATE VOLTAGE..... 1250 *max* volts
 STEADY-STATE PEAK PLATE CURRENT (Per Plate)..... 245 *max* ma
 AC PLATE SUPPLY VOLTAGE (Per Plate, rms)..... See Rating Chart
 DC OUTPUT VOLTAGE (At filter input)..... 350 *max* volts
 DC OUTPUT CURRENT (Each plate)..... 40 *max* ma
 HOT-SWITCHING TRANSIENT PLATE CURRENT..... #
 PEAK HEATER-CATHODE VOLTAGE..... 450 *max* volts
 Heater negative with respect to cathode..... 200 *max* volts
 Heater positive with respect to cathode..... 200 *max* volts

OPERATION CHARACTERISTICS

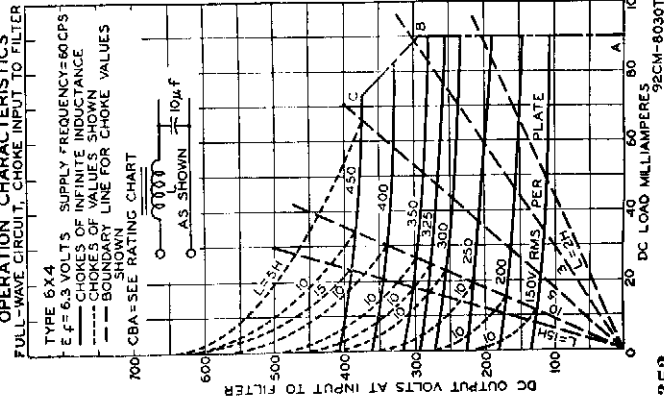

OPERATION CHARACTERISTICS

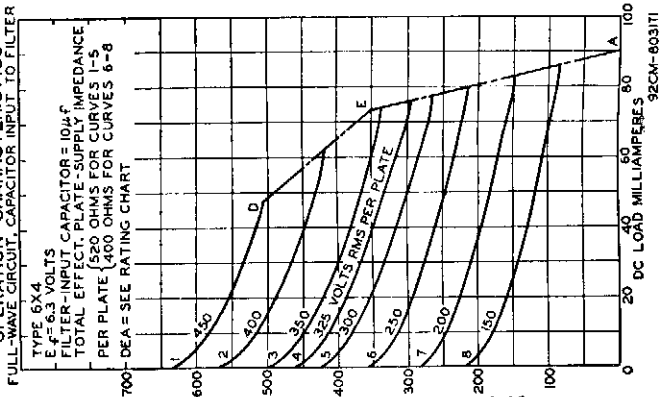

Typical Operation:

Filter Input	Sine-Wave Operation	Vibrator Operation
AC Plate Supply Voltage (Each plate, rms)*	Capacitor	Capacitor
Filter Input Capacitor	400	400
Effective Plate Supply Impedance (Each plate)	10	10
Filter Input Choke	525	—
DC Output Current	70	70
DC Output Voltage at Input to Filter (Approx.)	310	240

* When the heater is operated from a 3-cell (nominal-6-volt) storage-battery source, the permissible heater-voltage range is from 5 to 8 volts.
 † This rating applies when the 6X4 is used in vibrator operation with a minimum duty cycle of 75 per cent.
 # If hot-switching is regularly required in operation, the use of choke-input circuits is recommended. Such circuits limit the hot-switching current to a value no higher than that of the peak plate current. When resistor-input circuits are used, a maximum peak current value per plate of 1.1 amperes during the initial cycles of the hot-switching transient should not be exceeded.
 • The dc component must not exceed 100 volts.
 • AC plate supply voltage is measured without load.

RATING CHART

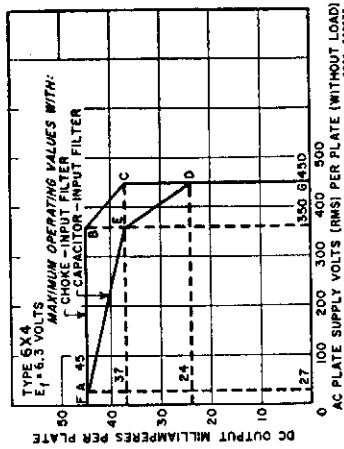

FULL-WAVE VACUUM RECTIFIER

6X5
6X5GT
 Metal type 6X5 and glass octal type 6X5-GT are used in power supply of automobile and ac-operated receivers. Outlines 5 and 14C, respectively, OUTLINES SECTION. Type 6X5-GT may be supplied with pin No.1 omitted. Both types require octal socket. Type 6X5 should be mounted in vertical position, but horizontal operation is permissible if pins 8 and 5 are in horizontal plane. Type 6X5-GT may be operated in any position. For maximum ratings, and typical operation, refer to type 6X4. Type 6X5 is a DISCONTINUED type listed for reference only.

MEDIUM-MU TRIODE—SHARP-CUTOFF PENTODE

Miniature type used as combined oscillator and mixer tube in television receivers utilizing an intermediate frequency in the order of 40 megacycles per second. In such service, the 6X8 gives performance comparable to that obtainable with a 6AG5 mixer and an oscillator consisting of one unit of a type 6J6. When used in an AM/FM receiver, the triode unit is used as an oscillator for both sections. In the AM section, the pentode unit is used as a high-gain pentode mixer; in the FM section, the pentode unit is used either as a pentode mixer or as a triode-connected mixer depending on signal-to-noise considerations. Outline 8B, OUTLINES SECTION. Tube requires miniature nine-contact socket and may be mounted in any position.

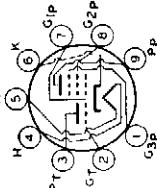

6X8

Related types:
5X8, 19X8

HEATER VOLTAGE.....	6.3	volts
HEATER CURRENT.....	0.45	ampere
DIRECT INTERELECTRODE CAPACITANCES:		
Triode Unit:		
Without External Shield.....	1.5	pf
With External Shield.....	2.4	pf
Pentode Unit:		
Without External Shield.....	1	pf
With External Shield.....	1.5	pf
Grid No.1 to Plate.....	0.09 maz	
Grid No.1 to Cathode, Heater, Grid No.2, and Grid No.3.....	4.6	pf
Plate to Cathode, Heater, Grid No.2, and Grid No.3.....	0.9	pf
Pentode Grid No.1 to Triode Plate.....	0.05 maz	
Pentode Plate to Triode Plate.....	0.05 maz	
Heater to Cathode.....	6.5*	pf

- * With external shield connected to cathode except as noted.
- With external shield connected to pentode plate.

CLASS A₁ AMPLIFIER

Maximum Ratings, (Design-Maximum Values):		
PLATE VOLTAGE.....	275 maz	Pentode Unit
GRID NO.2 (SCREEN-GRID) SUPPLY VOLTAGE.....	275 maz	volts
GRID-NO.2 VOLTAGE.....	See curve page 70	volts
GRID-NO.1 (CONTROL-GRID) VOLTAGE, Positive-bias value.....	0 maz	volts
PLATE DISSIPATION.....	1.7 maz	watts
GRID-NO.2 INPUT:		
For grid-No.2 voltages up to 137.5 volts.....	0.45 maz	watt
For grid-No.2 voltages between 137.5 and 275 volts.....	See curve page 70	
PEAK HEATER-CATHODE VOLTAGE:		
Heater negative with respect to cathode.....	200 maz	volts
Heater positive with respect to cathode.....	200 maz	volts

Characteristics:		
Plate Voltage.....	125	volts
Grid No.3.....	Connected to cathode at socket	
Grid-No.2 Voltage.....	125	volt
Grid-No.1 Voltage.....	-1	volt
Amplification Factor.....	40	
Plate Resistance (Approx.).....	6000	ohms
Transconductance.....	6500	μmhos
Plate Current.....	12	ma
Grid-No.2 Current.....	2.2	ma
Grid-No.1 Voltage (Approx.) for plate current of 20 μa.....	-7	volts

■ The dc component must not exceed 100 volts.

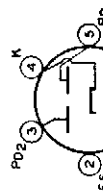
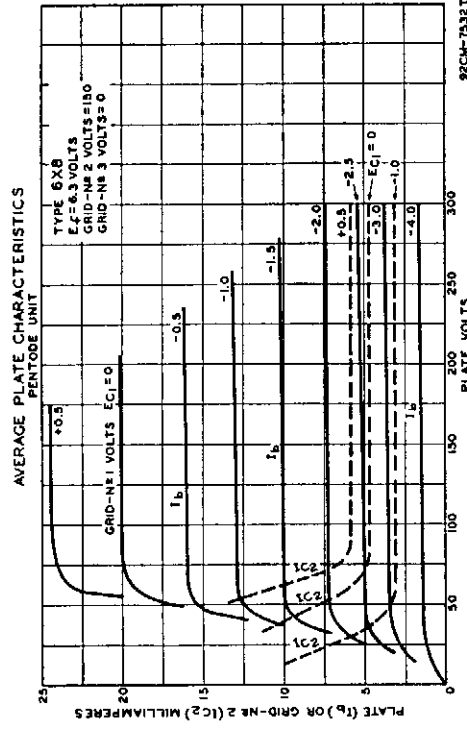
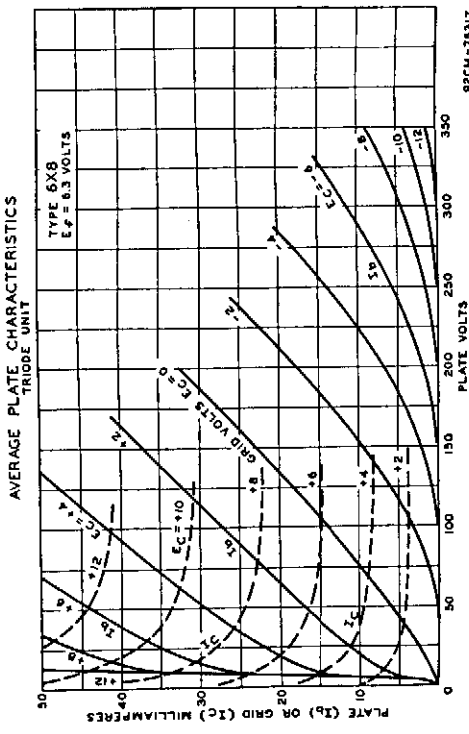

FULL-WAVE VACUUM RECTIFIER

Glass type used in power supply of radio receivers. Maximum dimensions: over-all length, 4-3/16 inches; seated height, 3-9/16 inches; diameter, 1-9/16 inches. Heater volts (ac/dc), 6.3; amperes, 0.8. The maximum ac plate voltage per plate is 350 volts (rms), and the dc output current is 60 ma. This is a DISCONTINUED type listed for reference only.

6Y5

BEAM POWER TUBE

Glass octal types used as output amplifier in radio receivers. Also used in rf-operated, high-voltage power supplies in television equipment. Except for envelope size and direct interelectrode capacitances, type 6Y6-G and type 6Y6-GA are identical. Outlines 26 and 19B, respectively, OUTLINES SECTION. Tubes require octal socket and may be mounted in any position.

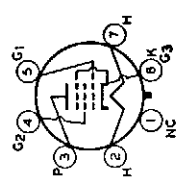

6Y6G
6Y6GA

HEATER VOLTAGE (AC/DC).....	6.3	volts
HEATER CURRENT.....	1.25	amperes
DIRECT INTERELECTRODE CAPACITANCES (Approx.):		
Grid No.1 to Plate.....	0.7	pf
Grid No.1 to Cathode, Heater, Grid No.2, and Grid No.3.....	15	pf
Plate to Cathode, Heater, Grid No.2, and Grid No.3.....	11	pf

CLASS A₁ AMPLIFIER

Maximum Ratings, (Design-Center Values):

PLATE VOLTAGE.....	200 maz	volts
GRID-NO.2 (SCREEN-GRID) SUPPLY VOLTAGE.....	200 maz	volts
GRID-NO.2 VOLTAGE.....	See curve page 70	
GRID-NO.2 INPUT:		
For grid-No.2 voltages up to 100 volts.....	1.75 maz	watts
For grid-No.2 voltages between 100 and 200 volts.....	See curve page 70	
PEAK HEATER-CATHODE VOLTAGE:		
Heater negative with respect to cathode.....	180 maz	volts
Heater positive with respect to cathode.....	180 maz	volts

Typical Operation:

Plate Voltage.....	185	volts
Grid-No.2 Voltage.....	195	volts
Grid-No.1 (Control-Grid) Voltage.....	-18.5	volts
Peak AF Grid-No.1 Voltage.....	14	volts

Zero-Signal Plate Current.....	58	ma
Maximum-Signal Plate Current.....	60	ma
Zero-Signal Grid-No.2 Current.....	3.5	ma
Maximum-Signal Grid-No.2 Current.....	11.5	ma
Plate Resistance (Approx.).....	9800	ohms
Transconductance.....	7000	μmhos
Total Harmonic Distortion.....	2000	ohms
Load Resistance.....	10	per cent
Maximum-Signal Power Output.....	3.6	watts

Maximum Circuit Values:

Grid-No.1-Circuit Resistance:
For fixed-bias operation.....
For cathode-bias operation.....

6Y7G

HIGH-MU TWIN POWER TRIODE

Glass octal type used as class B amplifier in output stage of radio receivers. Outline 22, OUTLINES SECTION. For electrical characteristics, refer to type 79. Heater volts (ac/dc), 6.3; amperes, 0.6. This is a DISCONTINUED type listed for reference only.

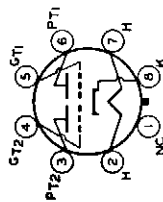

6Z4

Refer to type 84/6Z4

6Z5

FULL-WAVE VACUUM RECTIFIER

Glass type used in power supply of radio receivers. Maximum dimensions: over-all length, 4-3/16 inches; seated height, 3-9/16 inches; diameter, 1-9/16 inches. Heater volts (ac/dc), 12.6 (series), 6.3 (parallel); amperes, 0.4 (series), 0.8 (parallel). Maximum ac plate volts (per plate), 230; maximum dc output ma., 60. This is a DISCONTINUED type listed for reference only.

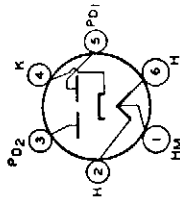

6Z7G

HIGH-MU TWIN POWER TRIODE

Glass octal type used as class B amplifier in output stage of radio receivers. Outline 22, OUTLINES SECTION. Tube requires octal socket. Heater volts (ac/dc), 6.3; amperes 0.3. Typical operation and maximum ratings as class B power amplifier: plate volts, 180 max; grid volts, 0; peak plate ma. per plate, 60 max; average plate dissipation, 8 max watts; zero-signal plate ma. per plate, 4.2; plate-to-plate load resistance, 12000 ohms; output watts, 4.2 with average input of 320 milliwatts applied between grids. This is a DISCONTINUED type listed for reference only.

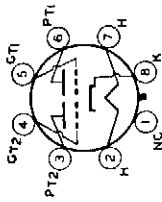

6ZYSG

FULL-WAVE VACUUM RECTIFIER

Glass octal type used in power supply of radio equipment where economy of power is important. Outline 22, OUTLINES SECTION. Tube requires octal socket and may be mounted in any position. Heater volts (ac/dc), 6.3; amperes, 0.3. Maximum ratings: peak inverse plate volts, 1250; peak plate ma. per plate, 120; dc output ma., 40; peak heater-cathode volts, 450. This is a DISCONTINUED type listed for reference only.

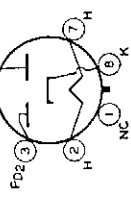

MEDIUM-MU TRIODE

Glass lock-in type used as detector, amplifier, oscillator in radio equipment. Outline 13A, OUTLINES SECTION. Tube requires lock-in socket. Heater volts (ac/dc), 6.3; amperes, 0.3. Maximum ratings, typical operating conditions, and curves for type 7A4 are the same as for metal type 6J5. Type 7A4 is used principally for renewal purposes.

7A4

7A5

BEAM POWER TUBE

Glass lock-in type used as output amplifier in radio receivers in which the plate voltage available for the output stage is relatively low. Outline 13B, OUTLINES SECTION. Tube requires lock-in socket. Heater volts (ac/dc), 6.3; amperes, 0.75. Typical operation and maximum ratings as class A1 amplifier: plate volts, 110 (125 max); grid-No.2 volts, 110 (125 max);

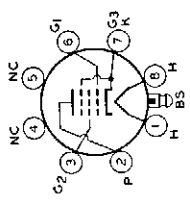

grid-No.1 volts, -7.5; peak at grid-No.1 voltage (approx.), 16,000 ohms; transconductance 5800 μmhos; plate ma., zero-signal, 40 (maximum-signal, 41); grid-No.2 ma., zero-signal, 3 (maximum-signal, 7); load resistance, 2600 ohms; total harmonic distortion, 10 per cent; maximum-signal power output, 1.5 watts; peak heater-cathode volts, 90 max. This type is used principally for renewal purposes.

TWIN DIODE

Glass lock-in type used as detector, low-voltage rectifier, or AVC tube. Outline 13A, OUTLINES SECTION. Tube requires lock-in socket. Heater volts (ac/dc), 6.3; amperes, 0.15. Maximum ratings as rectifier: ac plate volts, per plate (rms), 150; dc output ma. per plate, 8; peak ma. per plate, 45; peak heater-cathode volts, 330. The application of this type is similar to that of metal type 6H6. Type 7A6 is used principally for renewal purposes.

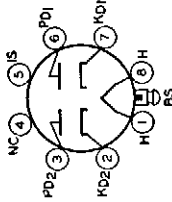

7A7

REMOTE-CUTOFF PENTODE

Glass lock-in type used as rf or if amplifier in radio receivers. Outline 13A, OUTLINES SECTION. Tube requires lock-in socket. Heater volts (ac/dc), 6.3; amperes, 0.3. For maximum ratings, typical operation, and curves, refer to metal type 6SK7. Type 7A7 is used principally for renewal purposes.

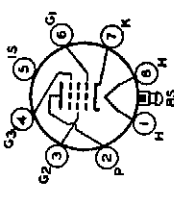

7A8

OCTODE CONVERTER

Glass lock-in type used as converter in superheterodyne circuits. Outline 13A, OUTLINES SECTION. Tube requires lock-in socket. Heater volts (ac/dc), 6.3; amperes, 0.15. Typical operation and maximum ratings as frequency converter: plate volts, 250 (300 max); grids-No.3-and-No.5 volts, 100 max; grid-No.2 supply volts, 250 applied through a 20000-ohm supply vol., 250 applied through a 20000-ohm No.5 input, 0.3 max watt; grid-No.2 input, 0.75 max watt; grid-No.4 volts, -3 (0 max); grid-No.1 resistor, 50000 ohms; plate ma., 3; grids-No.3-and-No.5 ma., 3.2; grid-No.2 ma., 4.2; grid-No.1 ma., 0.4; plate resistance (approx.), 0.7 megohm; conversion transconductance, 580 μmhos; peak heater-cathode volts, 90 max. This type is used principally for renewal purposes.

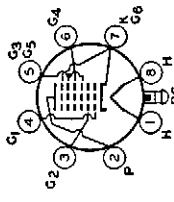

POWER PENTODE

Lock-in type used in output stage of video amplifier of television receivers. Outline 13B, OUTLINES SECTION. Tube requires lock-in socket. Heater volts (ac/dc), 6.3; amperes, 0.6. Characteristics and maximum ratings as Class A1 amplifier: plate supply volts, 300 max; grid-No.2 supply volts, 150 (300 max); grid-No.2 No.2 voltages between 150 and 300 volts, see curve page 70; plate dissipation, 10 max watts (for grid No.2 voltages between 150 and 300 volts, see curve page 70); plate resistance (approx.), 0.3 megohm; transconductance, 9300 μmhos; peak heater-cathode volts, 90 max. Type 7AD7 is a DISCONTINUED type listed for reference only.

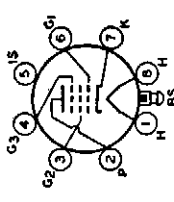

7AF7

MEDIUM-MU TWIN TRIODE

Glass lock-in type used as voltage amplifier or phase inverter in radio equipment. Outline 13A, OUTLINES SECTION. Tube requires lock-in socket. Heater volts (ac/dc), 6.3; amperes, 0.3. Characteristics and maximum ratings as Class A₁ amplifier (each unit): plate supply volts, 250 (300 max.); grid volts, positive-bias value, 0 max.; cathode-bias resistor, 1100 ohms; plate ma., 9; transconductance, 2100 μmhos; amplification factor, 16; plate resistance (approx.), 7600 ohms, peak heater-cathode volts, 90 max. This type is used principally for renewal purposes.

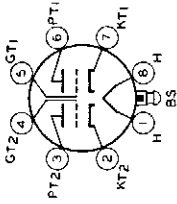

7AG7

SHARP-CUTOFF PENTODE

Glass lock-in type used as rf amplifier in ac/dc receivers or in mobile equipment where low heater current drain is important. Outline 13A, OUTLINES SECTION. Tube requires lock-in socket. Heater volts (ac/dc), 6.3; amperes, 0.15. Characteristics and maximum ratings as class A₁ amplifier: plate and grid-No.2 supply volts, 250 (300 max.); grid-No.1 volts, positive-bias value, 0 max.; plate dissipation, 2 max watts; grid-No.2 input, 0.75 max watt; grid-No.3 and internal shield connected to cathode at socket; plate resistance (approx.), greater than 1 megohm; transconductance, 4200 μmhos; cathode-bias resistor, 250 ohms; plate ma., 6; grid-No.2 ma., 2; peak heater-cathode volts, 90 max. This type is used principally for renewal purposes.

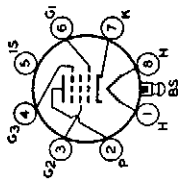

7AH7

SHARP-CUTOFF PENTODE

Glass lock-in type used as rf amplifier in high-frequency and wide-band applications. Outline 13A, OUTLINES SECTION. Tube requires lock-in socket. Heater volts (ac/dc), 6.3; amperes, 0.15. Characteristics and maximum ratings as class A₁ amplifier: plate and grid-No.2 supply volts, 250 (300 max.); grid-No.2 volts, 250 (see curve page 70); grid-No.1 volts, positive-bias value, 0 max.; plate dissipation, 2 max watts; grid-No.2 input, for grid-No.2 voltages up to 150 volts, 0.7 max watt (for grid-No.2 voltages from 150 to 300 volts, see curve page 70); cathode-bias resistor, 250 ohms; grid No.3 and internal shield connected to cathode at socket; plate resistance (approx.), 1 megohm; transconductance, 3300 μmhos; plate ma., 6.8; grid-No.2 ma., 1.9; peak heater-cathode volts, 90 max. Type 7AH7 is used principally for renewal purposes.

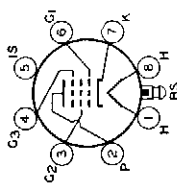

7AU7

MEDIUM-MU TWIN TRIODE

Miniature type used as combined vertical deflection amplifier and vertical deflection oscillator in television receivers. This type has a controlled heater warm-up time for use in receivers employing series-connected heater strings. Each unit may also be used as a horizontal deflection oscillator, or in audio mixer, phase inverter, multivibrator, sync separator and amplifier, and resistance-coupled amplifier circuits in radio equipment. Outline 8B, OUTLINES SECTION. Heater volts (ac/dc), 7 in series arrangement, 3.5 in parallel arrangement; amperes, 0.3 (series), 0.6 (parallel); warm-up time (average) in parallel arrangement, 11 seconds. Except for heater ratings, this type is identical with miniature type 12AU7-A.

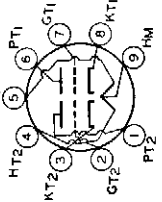

7B4

HIGH-MU TRIODE

Glass lock-in type used in resistance-coupled amplifier circuits. Outline 13A, OUTLINES SECTION. Tube requires lock-in socket. Heater volts (ac/dc), 6.3; amperes, 0.3. Except for interelectrode capacitances, this type has the same maximum ratings and characteristics as metal types 6F5 and 6SF5. Type 7B4 is used principally for renewal purposes.

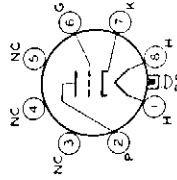

7B5

POWER PENTODE

Glass lock-in type used in output stage of radio receivers. Outline 13B, OUTLINES SECTION. Tube requires lock-in socket. Heater volts (ac/dc), 6.3; amperes, 0.4. Except for interelectrode capacitances, this type is the same electrically as glass-octal type 6K6-GT. Type 7B5 is used principally for renewal purposes.

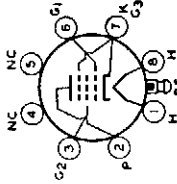

7B6

TWIN DIODE—HIGH-MU TRIODE

Glass lock-in type used as combined detector, amplifier, and avc tube. Outline 13A, OUTLINES SECTION. Tube requires lock-in socket. Heater volts (ac/dc), 6.3; amperes, 0.3. Except for interelectrode capacitances, this type is the same electrically as metal type 6SQ7. Type 7B6 is used principally for renewal purposes.

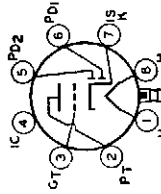

7B7

REMOTE-CUTOFF PENTODE

Glass lock-in type used as rf or if amplifier in radio receivers employing avc. Outline 13A, OUTLINES SECTION. Tube requires lock-in socket. Heater volts (ac/dc), 6.3; amperes, 0.15. Characteristics and maximum ratings as class A₁ amplifier: plate volts, 250 (300 max.); grid-No.2 volts, 100 max; grid-No.1 volts, -3 (positive-bias value, 0 max); grid No.3 and internal shield connected to cathode at socket; plate ma., 6.5; grid-No.2 ma., 1.7; grid-No.2 input, 0.25 max watt; plate dissipation, 2.25 max watts; plate resistance (approx.) 0.75 megohm; transconductance, 1750 μmhos; peak heater-cathode volts, 90 max. Type 7B7 is used principally for renewal purposes.

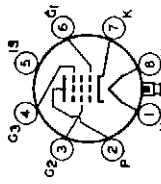

7B8

PENTAGRID CONVERTER

Glass lock-in type used as frequency converter in superheterodyne circuits. Outline 13A, OUTLINES SECTION. Tube requires lock-in socket. Heater volts (ac/dc), 6.3; amperes, 0.3. Except for interelectrode capacitances, this type is the same electrically as metal type 6A8. Type 7B8 is used principally for renewal purposes.

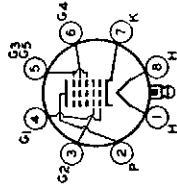

7C5

BEAM POWER TUBE

Glass lock-in type used as output amplifier in radio receivers. Outline 13B, OUTLINES SECTION. Tube requires lock-in socket. Heater volts (ac/dc), 6.3; amperes, 0.45. Refer to metal type 6V6 for maximum ratings and typical operation as class A₁ amplifier and as push-pull class A₁ amplifier. Type 7C5 is used principally for renewal purposes.

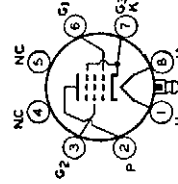

7C6

TWIN DIODE—HIGH-MU TRIODE

Glass lock-in type used as combined detector, amplifier, and avc tube. Outline 13A, OUTLINES SECTION. Tube requires lock-in socket. Heater volts (ac/dc), 6.3; amperes, 0.15. Characteristics and maximum ratings of triode unit as class A₁ amplifier: plate volts, 250 (300 max); grid volts, -1 (positive-bias value, 0 max); plate ma., 1.3; amplification factor, 100; plate resistance (approx.), 0.1 megohm; transconductance, 1900 μmhos; peak heater-cathode volts, 90 max. For diode operation curves and triode application, refer to miniature type 6AV6. Type 7C6 is used principally for renewal purposes.

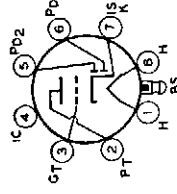

7C7

SHARP-CUTOFF PENTODE

Glass lock-in type used as biased detector or amplifier. Outline 13A, OUTLINES SECTION. Tube requires lock-in socket. Heater volts (ac/dc), 6.3; ampere, 0.15. Characteristics and maximum ratings as class A₁ amplifier: plate volts, 250 (300 max); grid-No.2 supply volts, 300 max; grid-No.2 volts, 100 max; grid-No.1 volts, -3 (positive-bias value, 0 max); grid-No.3 and internal shield connected to cathode at socket; grid-No.2 input, 1.5 max watt; plate dissipation, 1 max watt; plate resistance (approx.), 2 megohms; plate ma., 2; grid-No.2 ma., 2; trans-conductance, 1300 μ mhos; peak heater-cathode volts, 90 max. This type is used principally for renewal purposes.

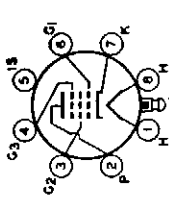

No.3 and internal shield connected to cathode at socket; grid-No.2 input, 0.1 max watt; plate dissipation, 1 max watt; plate resistance (approx.), 2 megohms; plate ma., 2; grid-No.2 ma., 0.5; trans-conductance, 1300 μ mhos; peak heater-cathode volts, 90 max. This type is used principally for renewal purposes.

7E6

TWIN DIODE—MEDIUM-MU TRIODE

Glass lock-in type used as combined detector, amplifier, and a.v.c. tube. Outline 13A, OUTLINES SECTION. Tube requires lock-in socket. Heater volts (ac/dc), 6.3; ampere, 0.3. For maximum ratings, typical operation, and curves, refer to miniature type 6BF6. Type 7E6 is a DISCONTINUED type listed for reference only.

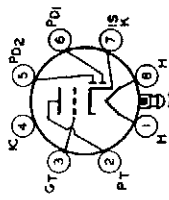

TWIN DIODE—REMOTE-CUTOFF PENTODE

Glass lock-in type used as combined detector, amplifier, and a.v.c. tube. Outline 13A, OUTLINES SECTION. Tube requires lock-in socket. Heater volts (ac/dc), 6.3; ampere, 0.3. Characteristics and maximum ratings of pentode unit as class A₁ amplifier: plate volts, 250 (300 max); grid-No.2 supply volts, 300 max; grid-No.2 volts, 100 max; grid-No.1 volts, -3 (positive-bias value, 0 max); plate dissipation, 2 max watt; grid-No.2 input, 0.3 max watt; cathode-bias resistor, 330 ohms; plate resistance (approx.), 0.7 megohm; trans-conductance, 1300 μ mhos; plate ma., 7.5; grid-No.2 ma., 1.6; peak heater-cathode volts, 90 max. For diode curves, refer to type 6AV6. Type 7E7 is used principally for renewal purposes.

7E7

BEAM POWER TUBE

Glass octal type used as vertical deflection amplifier in television receivers employing series-connected heater strings. Outline 14E, OUTLINES SECTION. Tube requires octal socket and may be operated in any position. Heater volts (ac/dc), 7.2; ampere, 0.6; warm-up time (average), 11 seconds. Except for heater ratings, this type is identical with glass octal type 6EY6.

7EY6

Related type:
6EY6

7F7

HIGH-MU TWIN TRIODE

Glass lock-in type used as phase inverter or resistance-coupled amplifier. Outline 13A, OUTLINES SECTION. Tube requires lock-in socket. Heater volts (ac/dc), 6.3; ampere, 0.3. For maximum ratings, typical operation as class A₁ amplifier, and curves, refer to glass-octal type 6SL7-GT. Type 7F7 is used principally for renewal purposes.

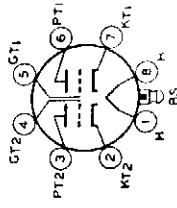

7F8

MEDIUM-MU TWIN TRIODE

Glass lock-in type used as amplifier or oscillator in radio equipment. Outline 13A, OUTLINES SECTION, except over-all length is 2-9/32 max inches and seated length is 1-3/4 inches. Tube requires lock-in socket. Heater volts (ac/dc), 6.3; ampere, 0.3. Characteristics and maximum ratings as class A₁ amplifier (each unit): plate supply volts, 250 (300 max); grid-No.1 volts, -3 (positive-bias value, 0 max); plate dissipation, 3.5 max watts (both units, 3.5 max watt); cathode-bias resistor, 500 ohms; plate ma., 6.0; trans-conductance, 3300 μ mhos; amplification factor, 48; peak heater-cathode volts, 90 max. This type is used principally for renewal purposes.

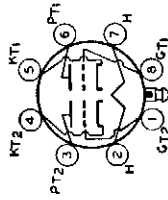

100 max; plate dissipation, 1.5 max watt; grid-No.2 input, 0.3 max watt; grid-No.1 volts, -2; grid-No.3 and internal shield connected to cathode at socket; plate resistance (approx.), 0.8 megohm; trans-conductance, 4500 μ mhos; plate ma., 6; grid-No.2 ma., 2.0; peak heater-cathode volts, 90 max. This type is used principally for renewal purposes.

SHARP-CUTOFF PENTODE

Glass lock-in type used in video amplifiers of television receivers and in other applications requiring high trans-conductance. Outline 19A, OUTLINES SECTION. Tube requires lock-in socket. Heater volts (ac/dc), 6.3; ampere, 0.45. Characteristics and maximum ratings as class A₁ amplifier: plate volts, 250 (300 max); grid-No.2 supply volts, 300 max; grid-No.2 volts, 100 max; grid-No.1 volts, -2; grid-No.3 and internal shield connected to cathode at socket; plate resistance (approx.), 0.8 megohm; trans-conductance, 4500 μ mhos; plate ma., 6; grid-No.2 ma., 2.0; peak heater-cathode volts, 90 max. This type is used principally for renewal purposes.

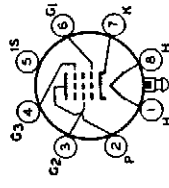

100 max; plate dissipation, 1.5 max watt; grid-No.2 input, 0.3 max watt; grid-No.1 volts, -2; grid-No.3 and internal shield connected to cathode at socket; plate resistance (approx.), 0.8 megohm; trans-conductance, 4500 μ mhos; plate ma., 6; grid-No.2 ma., 2.0; peak heater-cathode volts, 90 max. This type is used principally for renewal purposes.

SEMIREMOTE-CUTOFF PENTODE

Glass lock-in type used as rf or if amplifier in radio receivers. Outline 13A, OUTLINES SECTION. Tube requires lock-in socket. Heater volts (ac/dc), 6.3; ampere, 0.3. Characteristics and maximum ratings as class A₁ amplifier: plate volts, 250 (300 max); grid-No.2 supply volts, 300 max; grid-No.2 volts, 150 (see curve page 70); grid-No.1 volts, positive-bias value, 0 max; plate dissipation, 2.5 max watt; grid-No.2 input for grid-No.2 voltages up to 150 volts, 0.5 max watt (for grid-No.2 voltages between 150 and 300 volts, see curve page 70); grid-No.3 and internal shield connected to cathode at socket; cathode-bias resistor, 180 ohms; plate resistance (approx.), 0.8 megohm; trans-conductance, 4000 μ mhos; plate ma., 10; grid-No.2 ma., 3.2; peak heater-cathode volts, 90 max. This type is used principally for renewal purposes.

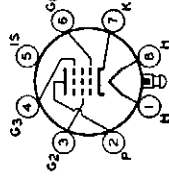

value, 0 max; plate dissipation, 2.5 max watt; grid-No.2 input for grid-No.2 voltages up to 150 volts, 0.5 max watt (for grid-No.2 voltages between 150 and 300 volts, see curve page 70); grid-No.3 and internal shield connected to cathode at socket; cathode-bias resistor, 180 ohms; plate resistance (approx.), 0.8 megohm; trans-conductance, 4000 μ mhos; plate ma., 10; grid-No.2 ma., 3.2; peak heater-cathode volts, 90 max. This type is used principally for renewal purposes.

TRIODE—HEPTODE CONVERTER

Glass lock-in type used as combined oscillator and heptode mixer in radio receivers. Outline 13A, OUTLINES SECTION. Tube requires lock-in socket. Heater volts (ac/dc), 6.3; ampere, 0.3. For maximum ratings and typical operation, refer to glass-octal type 6J8-G. Type 7J7 is used principally for renewal purposes.

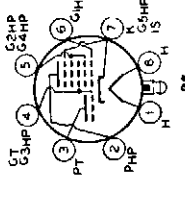

TWIN DIODE—HIGH-MU TRIODE

Glass lock-in type used as FM detector and audio amplifier in circuits which require diode and triode units with separate cathodes. Outline 13A, OUTLINES SECTION. Tube requires lock-in socket. Heater volts (ac/dc), 6.3; ampere, 0.3. For ratings and typical operation, refer to glass-octal type 6AQ7-GT. Type 7K7 is used principally for renewal purposes.

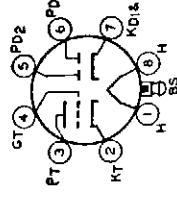

SHARP-CUTOFF PENTODE

Glass lock-in type used as rf and if amplifier in radio equipment. Outline 13A, OUTLINES SECTION. Tube requires lock-in socket. Heater volts (ac/dc), 6.3; amperes, 0.3. Typical operation as class A₁ amplifier: plate volts, 250 (300 max); grid-No.2 volts, 100; grid-No.1 volts, -1.5; grid No.3 tied to cathode at socket; cathode-bias resistor, 250 ohms; plate ma., 4.5; grid-No.2 ma., 1.5; plate resistance (approx.), 1 megohm; transconductance, 3100 μ mhos. This is a DISCONTINUED type listed for reference only.

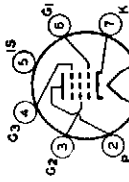

7L7

MEDIUM-MU TWIN TRIODE

Glass lock-in type used as voltage amplifier or phase inverter in radio equipment. Outline 13B, OUTLINES SECTION. Tube requires lock-in socket. Heater volts (ac/dc), 6.3; amperes, 0.6. For maximum ratings and typical operation of each triode unit, refer to metal type 6J5. The application of this type is similar to that of glass-socket type 6SN7-GT. Type 7N7 is used principally for renewal purposes.

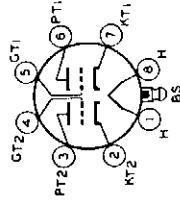

7N7

PENTAGRID CONVERTER

Glass lock-in type used as converter in superheterodyne circuits. Outline 13A, OUTLINES SECTION. Tube requires lock-in socket. Heater volts (ac/dc), 6.3; amperes, 0.3. For maximum ratings, typical operation in converter service, and curves, refer to metal type 6SA7. Type 7Q7 is used principally for renewal purposes.

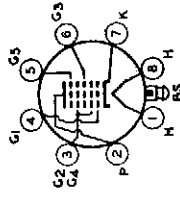

7Q7

TWIN DIODE—REMOTE-CUTOFF PENTODE

Glass lock-in type used as combined detector, amplifier, and AVC tube. Outline 13A, OUTLINES SECTION. Tube requires lock-in socket. Heater volts (ac/dc), 6.3; amperes, 0.3. Characteristics and maximum ratings of pentode unit as class A₁ amplifier: plate volts, 250 max; grid-No.2 supply volts, 250 max; grid-No.2 volts, 100 (see curve page 70); grid-No.1 volts, -1 (positive-bias value, 0 max); plate dissipation, 2 max watts; grid-No.2 input for grid-No.2 voltages up to 125, 0.25 max watt (for grid-No.2 voltages between 125 and 250 volts, see curve page 70); plate resistance (approx.), 1.0 megohm; transconductance, 3200 μ mhos; plate ma., 5.7; grid-No.2 ma., 2.1; peak heater-cathode volts, 90 max. Refer to type 6AV6 for diode curves. Type 7R7 is used principally for renewal purposes.

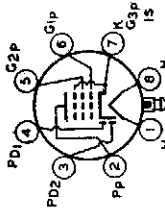

7R7

TRIODE—HEPTODE CONVERTER

Glass lock-in type used as combined triode oscillator and heptode mixer in radio receivers. Outline 13A, OUTLINES SECTION. Tube requires lock-in socket. Heater volts (ac/dc), 6.3; amperes, 0.3. Typical operation of heptode unit: plate volts, 250 (300 max); grids-No.2-and-No.4 volts, 100; grid-No.1 volts, -2; plate resistance, 1.25 megohms; conversion, transconductance, 525 μ mhos; plate ma., 1.8; grids-No.2-and-No.4 ma., 3.0. Typical operation of triode unit: plate supply volts, 250 (300 max) applied through a 20000-ohm dropping resistor bypassed by a 0.1- μ f capacitor; grid resistor, 50000 ohms; plate ma., 5.0; total cathode ma. (both units), 10.2. This is a DISCONTINUED type listed for reference only.

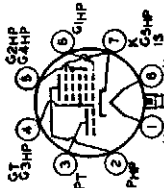

7S7



SHARP-CUTOFF PENTODE

Glass lock-in type used as rf or if amplifier in radio receivers. Outline 13A, OUTLINES SECTION. Tube requires lock-in socket. Heater volts (ac/dc), 6.3; amperes, 0.45. Characteristics and maximum ratings as class A₁ amplifier: plate and grid-No.2 supply volts, 300 max; grid-No.2 series resistor, 40000 ohms; plate dissipation, 4 max watts; grid-No.2 input, 0.8 max watt; grid No.3 connected to cathode at socket; cathode-bias resistor, 160 ohms; plate resistance (approx.), 0.3 megohm; transconductance, 5800 μ mhos; plate ma., 10; grid-No.2 ma., 3.9; peak heater-cathode volts, 90 max. This type is used principally for renewal purposes.

7W7

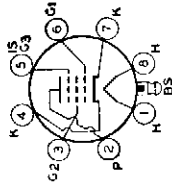

SHARP-CUTOFF PENTODE

Glass lock-in type used as rf or if amplifier in radio receivers. Outline 13A, OUTLINES SECTION. Tube requires lock-in socket. Heater volts (ac/dc), 6.3; amperes, 0.45. This type is the same as type 7V7 except for socket connections. Type 7W7 is used principally for renewal purposes.

7W7

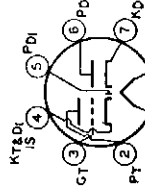

TWIN DIODE—HIGH-MU TRIODE

Glass lock-in type used as combined detector, amplifier, and AVC tube in circuits which require diodes with separate cathodes. Outline 13B, OUTLINES SECTION. Tube requires lock-in socket. Heater volts (ac/dc), 6.3; amperes, 0.3. Characteristics and maximum ratings of triode unit as class A₁ amplifier: plate volts, 250 (300 max); grid volts, -1; amplification factor, 100; plate resistance (approx.), 67000 ohms; transconductance, 1500 μ mhos; plate ma., 1.9; peak heater-cathode volts, 90 max. This type is used principally for renewal purposes.

7X7

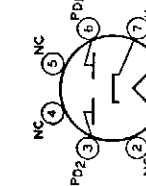

FULL-WAVE VACUUM RECTIFIER

Glass lock-in type used in power supply of automobile radio receivers and compact-operated receivers. Outline 13A, OUTLINES SECTION. Tube requires lock-in socket. Heater volts (ac/dc), 6.3; amperes, 0.5. Maximum ratings: peak inverse plate volts, 1250; peak plate ma. per plate, 180; dc output ma. 70; peak heater-cathode volts, 450. For typical operation, refer to miniature type 6X4. Type 7Y4 is used principally for renewal purposes.

7Y4

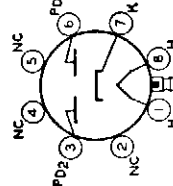

FULL-WAVE VACUUM RECTIFIER

Glass lock-in type used in power supply of automobile and ac-operated radio receivers. Outline 13B, OUTLINES SECTION. Tube requires lock-in socket. Heater volts (ac/dc), 6.3; amperes, 0.9. Maximum ratings: peak inverse plate volts, 1250; peak plate ma. per plate, 300; dc output ma. 100; peak heater-cathode volts, 450. Typical operation with capacitor-input filter: ac plate-to-plate supply volts (rms), 650; total effective plate-supply impedance per plate, 75 μ ohms; dc output ma., 100. Typical operation with choke-input filter: ac plate-to-plate supply volts (rms), 900; filter-input choke, 6 μ henries; dc output ma., 100. This type is used principally for renewal purposes.

7Z4

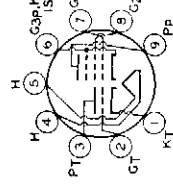

MEDIUM-MU TRIODE—SHARP-CUTOFF PENTODE

Miniature type used in a wide variety of applications in television receivers employing series-connected heater strings. The pentode unit is used as a video amplifier, an if amplifier, or

8AU8

Related type: 6AU8A

an agc amplifier. The triode unit is used in sync-amplifier, sync-separator, sync-clipper, and phase-inverter circuits. Outline 8D, OUTLINES SECTION. Heater volts (ac/dc), 8.4; amperes, 0.45. Except for heater ratings, this type is identical with type 6A8S.

**HIGH-MU TRIODE—
SHARP-CUTOFF PENTODE**

Miniature type used in a wide variety of applications in television receivers employing series-connected heater strings. The pentode unit is used as an amplifier and the triode unit is used in low-frequency oscillator or sync circuits. Outline 8D, OUTLINES SECTION. Heater volts (ac/dc), 8.4; amperes, 0.45; warm-up time (average), 11 seconds. Except for heater ratings, this type is identical with miniature type 6AW8-A.

8AW8A

Related types:
6AW8A

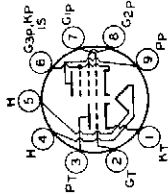

**TWIN DIODE—
MEDIUM-MU TWIN TRIODE**

Duodecar type used as combined horizontal-deflection oscillator and horizontal phase detector in television receivers employing series-connected heater strings. Outline 12A, OUTLINES SECTION. Heater volts (ac/dc), 8.5; amperes, 0.45; warm-up time (average), 11 seconds. Except for heater ratings, this type is identical with duodecar type 6B10.

8B10

Related types:
6B10

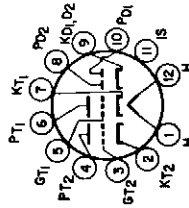

**MEDIUM-MU TRIODE—
SHARP-CUTOFF PENTODE**

Miniature type used in a wide variety of applications in color and black-and-white television receivers employing series-connected heater strings. The pentode unit is used as a video amplifier, an agc amplifier, or a reactance tube. The triode unit is used in low-frequency oscillator and phase-splitter circuits. Outline 8D, OUTLINES SECTION. Tube requires miniature nine-contact socket and may be operated in any position. Heater volts (ac/dc), 8.4; amperes, 0.45. Except for heater ratings, this type is identical with miniature type 6BA8-A.

8BA8A

Related types:
6BA8A

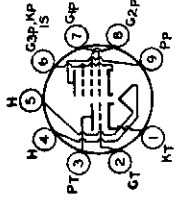

**MEDIUM-MU TRIODE—
SHARP-CUTOFF PENTODE**

Miniature type used in a wide variety of applications in television receivers employing series-connected heater strings. The pentode unit is used as an if amplifier, a video amplifier, or an agc amplifier. The triode unit is used in low-frequency oscillator circuits. Outline 8D, OUTLINES SECTION. Heater volts (ac/dc), 8.4; amperes, 0.45. Except for heater ratings, this type is identical with type 6BH8.

8BH8

Related types:
6BH8

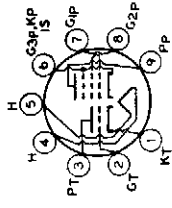

**TWIN DIODE—
HIGH-MU TRIODE**

Miniature type used in a wide variety of applications in color and black-and-white television receivers employing series-connected heater strings. The triode unit is used in burst amplifier, af amplifier, and low-frequency oscillator applications. The diode units are used in phase-detector, radio-detector or discriminator, and horizontal AFC discriminator circuits. Outline 8D, OUTLINES SECTION. Heater volts (ac/dc), 8.4; amperes, 0.45. Except for heater ratings, this type is identical with type 6BN8.

8BN8

Related types:
6BN8

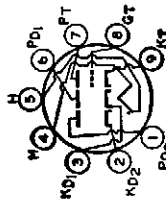

POWER PENTODE

Miniature type used in the output stage of audio-frequency amplifiers employing series-connected heater strings Outline 8E, OUTLINES SECTION. Heater volts (ac/dc), 8; amperes, 0.6; warm-up time (average), 11 seconds. Except for heater ratings, this type is identical with type 6BQ5.

8BQ5

Related types:
6BQ5

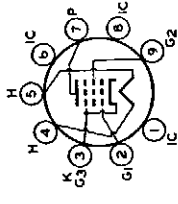

MEDIUM-MU TWIN TRIODE

Miniature type used as combined vertical deflection and horizontal deflection oscillator in television receivers employing series-connected heater strings. Outline 8D, OUTLINES SECTION. Heater volts (ac/dc), 8.4; amperes, 0.45; warm-up time (average), 11 seconds. Except for heater ratings, this type is identical with miniature type 6CG7.

8CG7

Related types:
6CG7

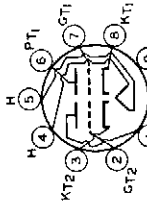

MEDIUM-MU DUAL TRIODE

Miniature type used as combined vertical oscillator and vertical deflection amplifier in television receivers employing series-connected heater strings. Outline 8D, OUTLINES SECTION. Heater volts (ac/dc), 8.4; amperes, 0.45; warm-up time (average), 11 seconds. Except for heater ratings, this type is identical with miniature type 6CM7.

8CM7

Related types:
6CM7

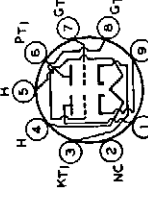

**TWIN DIODE—
HIGH-MU TRIODE**

Miniature type used as combined horizontal phase detector and reactance tube in television receivers employing series-connected heater strings. The triode unit is used in sync separator, sync-amplifier, or audio-amplifier circuits. Outline 8B, OUTLINES SECTION. Heater volts (ac/dc), 8.4 (series), 4.2 (parallel); amperes, 0.225 (series), 0.45 (parallel); warm-up time (average), 11 seconds (parallel). Except for heater ratings, this type is identical with type 6CN7.

8CN7

Related types:
6CN7

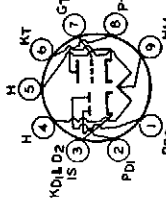

MEDIUM-MU DUAL TRIODE

Miniature type used as combined vertical-deflection oscillator and vertical-deflection amplifier in television receivers employing series-connected heater strings. Outline 8D, OUTLINES SECTION. Heater volts (ac/dc), 8.4; amperes, 0.45; heater warm-up time (average), 11 seconds. Except for heater ratings, this type is identical with type 6CS7.

8CS7

Related type: 6CS7

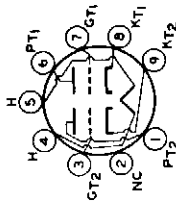

SECTION. Heater volts (ac/dc), 8.4; amperes, 0.45; heater warm-up time (average), 11 seconds. Except for heater ratings, this type is identical with type 6CS7.

MEDIUM-MU TRIODE—SHARP-CUTOFF PENTODE

Miniature type used in television receivers employing series-connected heater strings. Pentode unit is used as video amplifier; triode unit is used in sound if amplifier, sweep-oscillator, sync-separator, sync-amplifier, and sync-clipper circuits. Outline 8D, OUTLINES SECTION. Heater volts (ac/dc), 8; amperes, 0.6; warm-up time (average), 11 seconds. Except for heater ratings, this type is identical with type 6CX8.

8CX8

Related type: 6CX8

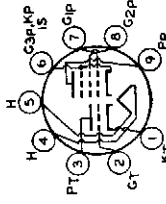

HIGH-MU TRIODE—SHARP-CUTOFF PENTODE

Miniature type used in color and black-and-white television receivers employing series-connected heater strings. The pentode unit is used as a video output amplifier; the triode unit is used in sync-separator, sync-clipper, and phase-inverter circuits. Outline 8D, OUTLINES SECTION. Heater volts (ac/dc), 8; amperes, 0.6; warm-up time (average), 11 seconds. Except for heater ratings, this type is identical with miniature type 6EB8.

8EB8

Related type: 6EB8

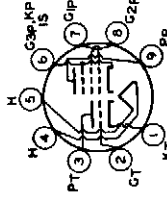

BEAM POWER TUBE

Miniature type used as vertical deflection amplifier in television receivers utilizing picture tubes having diagonal deflection angles of 110 degrees and employing series-connected heater strings. Outline 8E, OUTLINES SECTION. Heater volts (ac/dc), 8.4; amperes, 0.6; warm-up time (average), 11 seconds. Except for heater ratings, this type is identical with miniature type 6EM5.

8EM5

Related type: 6EM5

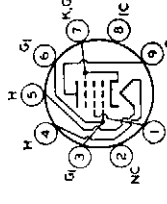

TWIN DIODE—SHARP-CUTOFF PENTODE

Miniature type used in television receivers employing series-connected heater strings. The pentode unit is used as a video amplifier and the diodes are used as a horizontal phase inverter. Outline 8D, OUTLINES SECTION. Tube requires miniature nine-contact socket and may be operated in any position. Heater volts (ac/dc), 8; amperes, 0.6; warm-up time (average), 11 seconds.

8ET7

Related type: 8ET7

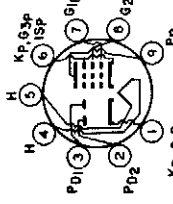

PENTODE UNIT AS CLASS A1 AMPLIFIER

Maximum Ratings, (Design-Maximum Values):

PLATE VOLTAGE.....	330 <i>max</i>	volts
GRID-NO.2 (SCREEN-GRID) SUPPLY VOLTAGE.....	330 <i>max</i>	volts
GRID-NO.2 VOLTAGE.....	See curve page 70	volts
GRID-NO.1 (CONTROL-GRID) VOLTAGE, Positive-bias value.....	0 <i>max</i>	volts
GRID-NO.2 INPUT.....	1.1 <i>max</i>	watts
For grid-No.2 voltages up to 165 volts.....	See curve page 70	watts
For grid-No.2 voltages between 165 and 330 volts.....	5 <i>max</i>	watts
PLATE DISSIPATION.....	200 <i>max</i>	volts
PEAK HEATER-CATHODE VOLTAGE.....	200 <i>max</i>	volts
Heater negative with respect to cathode.....		
Heater positive with respect to cathode.....		

Characteristics:

Plate Supply Voltage.....	60	volts
Grid-No.2 Supply Voltage.....	150	volts
Grid-No.1 Voltage.....	0	volts
Cathode-Bias Resistor.....	100	ohms
Plate Resistance (Approx.).....	60000	ohms
Transconductance.....	11500	μmhos
Plate Current.....	55	ma
Grid-No.2 Current.....	18	ma
Grid-No.1 Voltage (Approx.) for plate current of 100 μ A.....	-10	volts

Maximum Circuit Values:

Grid-No.1-Circuit Resistance For fixed-bias operation.....	0.1 <i>max</i>	megohm
For cathode-bias operation.....	0.25 <i>max</i>	megohm

DIODE UNITS

Maximum Ratings, (Design-Maximum Values):

DC PLATE CURRENT.....	3 <i>max</i>	ma
PEAK HEATER-CATHODE VOLTAGE.....	200 <i>max</i>	volts
Heater negative with respect to cathode.....		
Heater positive with respect to cathode.....		
Characteristics, Instantaneous Value:		
Tube Voltage Drop for plate current of 1.5 ma.....	10	volts

This dc component must not exceed 100 volts. This value can be measured by a method involving a recurrent waveform such that the maximum ratings of the tube will not be exceeded.

MEDIUM-MU TWIN TRIODE

Miniature type used as combined vertical- and horizontal-deflection oscillator in television receivers employing series-connected heater strings. Outline 8D, OUTLINES SECTION.

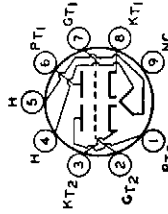

Tube requires miniature nine-contact socket and may be operated in any position. Heater volts (ac/dc), 8.4; amperes, 0.45. Except for heater ratings, the 8FQ7 is identical with type 6FQ7.

8FQ7

Related type: 6FQ7

HIGH-MU TRIODE—SHARP-CUTOFF PENTODE

Miniature type used in color and black-and-white television receivers employing series-connected heater strings. Triode unit is used in voltage-amplifier applications; pentode unit is used in output stage of video amplifier. Outline 8D, OUTLINES SECTION. Tube requires miniature nine-contact socket and may be operated in any position. Heater volts (ac/dc), 8; amperes, 0.6; heater warm-up time (average), 11 seconds. Except for heater ratings, this type is identical with type 6GN8.

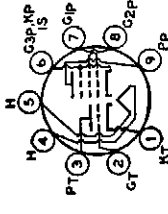

8GN8

Related types: 6GN8, 10GN8

HIGH-MU TRIODE—SHARP-CUTOFF PENTODE

Miniature type used in a wide variety of applications in television receivers, particularly those having low-voltage "B" supplies and employing series-connected heater strings. The

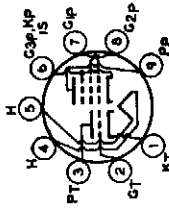

8JV8
Related type:
6JV8

triode unit is used in sound-if, keyed-agc, sync-separator, sync-amplifier, and noise-suppression circuits. The pentode unit is especially useful as a video amplifier tube. Outline 8D, OUTLINES SECTION. Heater volts (ac/dc), 8.5; amperes, 0.45; warm-up time (average), 11 seconds. Except for heater ratings, this type is identical with miniature type 6JV8.

HIGH-MU TRIODE—SHARP-CUTOFF PENTODE

Miniature type used in color and black-and-white television receivers employing series-connected heater strings. The triode unit is used in sync-separator circuits; the pentode unit has two independent control grids and is used in gated-agc-amplifier and noise-inverter circuits. Outline 8D, OUTLINES SECTION. Heater volts (ac/dc), 8.4; amperes, 0.45; warm-up time (average), 11 seconds. Except for heater ratings, this type is identical with miniature type 6KA8.

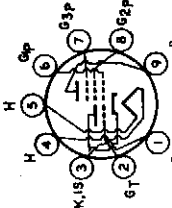

8KA8
Related type:
6KA8

has two independent control grids and is used in gated-agc-amplifier and noise-inverter circuits. Outline 8D, OUTLINES SECTION. Heater volts (ac/dc), 8.4; amperes, 0.45; warm-up time (average), 11 seconds. Except for heater ratings, this type is identical with miniature type 6KA8.

MEDIUM-MU TWIN TRIODE

Miniature type used as combined vertical-deflection-amplifier and vertical-deflection-oscillator in television receivers employing series-connected heater strings. Outline 8B, OUTLINES SECTION. Heater volts (ac/dc), 9.4 (series), 4.7 (parallel); warm-up time (average), 11 seconds (parallel). Except for heater ratings, this type is identical with type 12AU7-A.

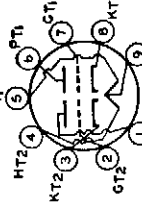

9AU7
Related types:
7AU7, 12AU7A

SECTION. Heater volts (ac/dc), 9.4 (series), 4.7 (parallel); amperes, 0.225 (series), 0.45 (parallel); warm-up time (average), 11 seconds (parallel). Except for heater ratings, this type is identical with type 12AU7-A.

TWIN DIODE—HIGH-MU TRIODE

Miniature type used as combined sync separator and horizontal phase detector in television receivers employing series-connected heater strings. Outline 8B, OUTLINES SECTION. Tube requires miniature nine-contact socket. Heater volts (ac/dc), 9.4 (series), 4.7 (parallel); amperes, 0.3 (series), 0.6 (parallel); warm-up time (average), 11 seconds. Characteristics of triode unit as class A₁ amplifier: plate supply volts, 250 (300 max); cathode-bias resistor, 200 ohms; amplification factor, 60; plate resistance (approx.), 10900 ohms; transconductance, 4000 μmhos; plate ma, 10; plate dissipation, 2.5 max watts. Maximum ratings of diode unit: peak inverse plate volts, 300 max; peak plate ma, 60 max. Peak heater-cathode volts: heater negative with respect to cathode, 300 max; heater positive with respect to cathode, 200 max (the dc component must not exceed 100 volts). This type is used principally for renewal purposes.

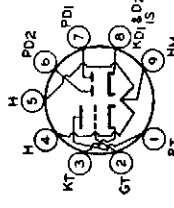

9BR7

MEDIUM-MU TRIODE—SHARP-CUTOFF TETRODE

Miniature type used as combined oscillator and mixer in vhf tuners of television receivers employing series-connected heater strings. Outline 8B, OUTLINES SECTION. Tube requires

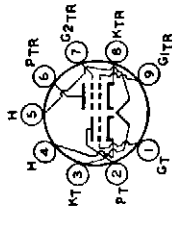

9CL8

miniature nine-contact socket and may be mounted in any position. Heater volts (ac/dc), 9.5; amperes, 0.3; warm-up time (average), 11 seconds.

CLASS A₁ AMPLIFIER

Maximum Ratings, (Design-Center Values):

PLATE VOLTAGE.....	300 max	Triode Unit	300 max
GRID-NO.2 (SCREEN-GRID) SUPPLY VOLTAGE.....	0 max	Tetrode Unit	300 max
GRID-NO.2 VOLTAGE.....	2.7 max	See curve page 70	0.5 max
GRID-NO.1 (CONTROL-GRID) VOLTAGE, Positive-bias value.....	200 max	See curve page 70	2.8 max
GRID-NO.2 INPUT:			
For grid-No.2 voltages up to 150 volts.....	200 max		
For grid-No.2 voltages between 150 and 300 volts.....	200 max		
PEAK HEATER-CATHODE VOLTAGE:			
Heater negative with respect to cathode.....	300 max		
Heater positive with respect to cathode.....	200 max		

■ The dc component must not exceed 100 volts.

Characteristics:

Plate Supply Voltage.....	125	volts
Grid-No.2 Supply Voltage.....	—	volts
Grid-No.1 Voltage.....	—1	volt
Cathode-Bias Resistor.....	56	ohms
Amplification Factor.....	40	—
Plate Resistance (Approx.).....	5000	ohms
Transconductance.....	8000	μmhos
Plate Current.....	15	ma
Grid-No.2 Current.....	4	ma
Grid-No.1 Voltage (Approx.) for plate current of 10 μa.....	-9	volts

Maximum Circuit Values:

Grid-No.1-Circuit Resistance:	0.5 max	megohm
For fixed-bias operation.....	1 max	megohm
For cathode-bias operation.....		

MEDIUM-MU TRIODE—SHARP-CUTOFF PENTODE

Miniature type used in television receivers employing series-connected heater strings. Tube is used as combined oscillator and mixer tube in vhf tuners of television receivers utilizing

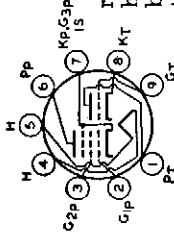

9U8A

Related types:
5U8, 6U8A

an intermediate frequency in the order of 40 megacycles per second. Outline 8B, OUTLINES SECTION. Heater voltage (ac/dc), 9.45; amperes, 0.3, warm-up time (average), 11 seconds. Except for heater ratings, this type is identical with type 6U8-A.

POWER TRIODE

Glass type used as an audio-frequency amplifier. Outline 28, OUTLINES SECTION. Tube requires four-contact socket. Filament volts (ac/dc), 7.5; amperes, 1.25. Typical operation as class A₁ af power amplifier: plate volts, 425 max; grid volts, -40; peak af grid volts, 35; plate ma, 18; plate resistance, 5000 ohms; transconductance, 1600 μmhos; load resistance, 10200 ohms; undistorted output watts, 1.6. This is a DISCONTINUED type listed for reference only.

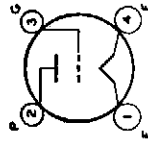

10

HIGH-MU TRIODE—SHARP-CUTOFF PENTODE

Miniature type used in diversified applications in television receivers employing series-connected heater strings. The pentode unit is used as a general-purpose amplifier tube; the triode unit is used in vertical-deflection-oscillator, sync-separator, sync-clipper, and sync-amplifier circuits. Outline 8B, OUTLINES SECTION. Tube requires miniature nine-contact socket. Heater volts (ac/dc), 10.5; amperes, 0.3;

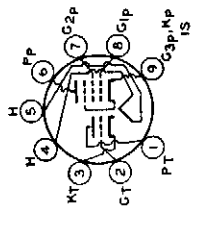

warm-up time (average), 11 seconds. Characteristics of triode unit as class A₁ amplifier: plate supply volts, 250 (300 max); cathode-bias resistor, 390 ohms; amplification factor, 53; plate resistance (ap-

10C8

prox.), 12000 ohms; transconductance, 4400 μ hos; plate ma., 7.3. Pentode unit: plate and grid-No.2 supply volts, 135 (300 max); cathode-bias resistor, 100 ohms; plate resistance (approx.), 0.19 megohm; transconductance, 8000 μ hos; plate ma., 11.5; grid-No.2 ma., 3.2. Maximum ratings as vertical-deflection oscillator (triode unit) and amplifier (pentode unit) for operation in a 525-line, 30-frame system: plate volts, 300 max ; peak positive-pulse plate volts (amplifier), 1000 max ; peak negative-pulse grid-No.1 volts, -400 max (oscillator), -250 max (amplifier); peak cathode ma., 35 max (oscillator), 55 max (amplifier); average cathode ma., 12 max (oscillator), 18 max (amplifier); plate dissipation, 1 max watt (oscillator), 2.5 max watts (amplifier); peak heater-cathode volts, 200 max (the dc component must not exceed 100 volts). This type is used principally for renewal purposes.

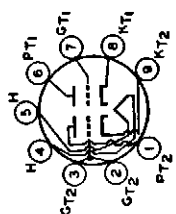

DUAL TRIODE

Miniature type used as combined vertical oscillator and vertical deflection amplifier in television receivers employing series-connected heater strings. Unit No.1 is a medium-mu

triode unit used as a blocking oscillator in vertical-deflection circuits, and unit No.2 is a low-mu triode unit used as a vertical-deflection amplifier. Outline 8D, OUTLINES SECTION. Heater volts (ac/dc), 9.7; amperes, 0.6; warm-up time (average), 11 seconds. Except for heater ratings, this type is identical with miniature type 6DE7.

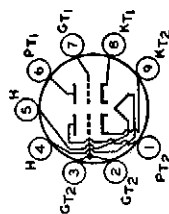

DUAL TRIODE

Miniature type used as combined vertical-deflection-oscillator and vertical-deflection-amplifier tube in television receivers employing series-connected heater strings. Outline 8D,

OUTLINES SECTION. Tube requires miniature nine-contact socket and may be operated in any position. Heater volts (ac/dc), 9.7; amperes, 0.6; warm-up time (average), 11 seconds. Except for heater ratings, the 10DR7 is identical with type 6DR7.

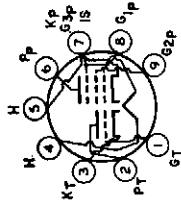

**HIGH-MU TRIODE—
SHARP-CUTOFF PENTODE**

Miniature type used in television-receiver applications. The triode unit is used as a sync-separator, sync-amplifier, keyed-agc, or noise-suppressor tube. The pentode unit is used as a

video output tube. Outline 8D, OUTLINES SECTION. Heater volts (ac/dc), 10.2; amperes, 0.45. Except for heater ratings, this type is identical with miniature type 6DX8.

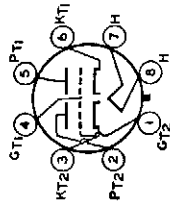

DUAL TRIODE

Glass octal type used as combined vertical-deflection oscillator and vertical-deflection amplifier in television receivers employing series-connected heater strings. Outline 19, OUTLINES

SECTION. Tube requires octal socket and may be operated in any position. Heater volts (ac/dc), 9.7; amperes, 0.6; warm-up time (average), 11 seconds. For maximum ratings and characteristics, refer to type 6EW7.

DUAL TRIODE

Glass octal type containing high-mu triode and high-perveance, low-mu triode in same envelope. Used as combined vertical-deflection oscillator and vertical-deflection amplifier in televi-

sion receivers employing series-connected heater strings. Outline 14A, OUTLINES SECTION. Heater volts (ac/dc), 9.7; amperes, 0.6; warm-up time (average), 11 seconds. Except for heater ratings, this type is identical with type 6EM7.

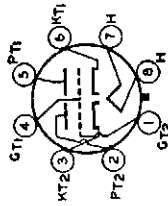

10EM7

Related types:
6EM7, 13EM7

DUAL TRIODE

Novar type containing high-mu and high-perveance, low-mu triode units used as combined vertical-deflection amplifier and vertical-deflection oscillator in television receivers employing series-connected heater strings. Outline 10A, OUTLINES SECTION. Heater volts (ac/dc), 9.7; amperes, 0.6; warm-up time (average), 11 seconds. Except for heater ratings, this type is identical with novar type 6GF7.

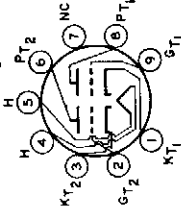

10GF7

Related types:
6GF7, 13GF7

**HIGH-MU TRIODE—
SHARP-CUTOFF PENTODE**

Miniature type used in color and black-and-white television receivers employing series-connected heater strings. The triode unit is used as a sync-separator, sync-clipper, phase-inverter, or sound-if-amplifier tube. The pentode unit is used in the output stage of video amplifiers. Outline 8D, OUTLINES SECTION. Heater volts (ac/dc), 10.5; amperes, 0.45; warm-up time (average), 11 seconds. Except for heater ratings, this type is identical with miniature type 6GN8.

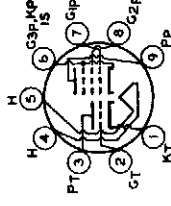

10GN8

Related types:
6GN8, 8GN8

**HIGH-MU TRIODE—
SHARP-CUTOFF PENTODE**

Miniature type used in color and black-and-white television receivers employing series-connected heater strings. Triode unit is used in high-gain, sound-if stages and in sync-separator, sync-clipper, and phase-inverter circuits; pentode unit is used as video-output amplifier. Outline 8D, OUTLINES SECTION. Tube requires miniature nine-contact socket and may be operated in any position. Heater volts (ac/dc), 10.5; amperes, 0.45; warm-up time (average), 11 seconds. Except for heater ratings, this type is identical with miniature type 6HF8.

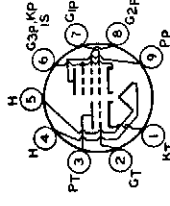

10HF8

Related type:
6HF8

**HIGH-MU TRIODE—
SHARP-CUTOFF TETRODE**

Miniature type used in color and black-and-white television receivers employing series-connected heater strings. The triode unit is used as a sync-separator, sync clipper, and phase inverter; the tetrode unit is used as a video amplifier. Outline 8D, OUTLINES

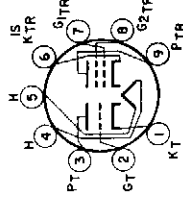

10JA8

SECTION. Tube requires miniature nine-contact socket and may be mounted in any position. Heater volts (ac/dc), 10.5; amperes, 0.45; warm-up time (average), 11 seconds.

CLASS A₁ AMPLIFIER

Maximum Ratings, (Design-Maximum Values):

PLATE VOLTAGE.....	volts	Triode Unit	300 max	volts	Tetradode Unit	330 max
GRID-NO.2 (SCREEN-GRID) SUPPLY VOLTAGE.....	volts	Unit	330 max	volts	Unit	330 max
GRID-NO.2 VOLTAGE.....	See curve page 70			See curve page 70		
GRID-NO.1 (CONTROL-GRID) VOLTAGE, Positive-bias value.....	volts		0 max	volts		0 max
PLATE DISSIPATION.....	watts		1 max	watts		5 max
GRID-NO.2 INPUT.....						

For grid-No.2 voltages up to 165 volts.
 For grid-No.2 voltages between 165 and 330 volts.
PEAK HEATER-CATHODE VOLTAGE:
 Heater negative with respect to cathode.....
 Heater positive with respect to cathode.....

Characteristics:

Plate Voltage.....	200	Triode Unit	200	volts	Tetradode Unit	200
Grid-No.2 Voltage.....	135	Unit	135	volts	Unit	135
Grid-No.1 Voltage.....	0		-1.5	volts		-1.5
Amplification Factor.....	60		70			7000
Plate Resistance.....	23000		17000	ohms		14000
Transconductance.....	2600		4000	μmhos		18
Plate Current.....	2		4	ma		4
Grid-No.2 Current.....	-		14*	ma		4
Grid-No.1 Voltage (Approx.) for plate current of 10 μa.....	-4.8		-7	volts		-5

Maximum Circuit Values:

Grid-No.1-Circuit Resistance:	0.25 max	Tetradode Unit	0.25 max
For fixed-bias operation.....	1 max	Unit	1 max
For cathode-bias operation.....			

* The dc component must not exceed 100 volts.
 † This value can be measured by a method involving a recurrent waveform such that the maximum ratings of the tube will not be exceeded.

DETECTOR AMPLIFIER

Glass type used as detector and amplifier in battery-operated receivers. Filament volts (dc), 1.1; amperes, 0.25. Typical operation as class A₁ amplifier: plate volts, 135 max; grid volts, -10.5; plate resistance (approx.), 15500 ohms; transconductance, 440 μmhos; plate ma., 3. This is a DISCONTINUED type listed for reference only.

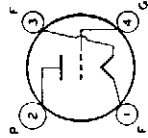

11

11AR11

Related type: 6AR11

0.45; warm-up time (average), 11 seconds. Except for heater ratings, this type is identical with duodecatriode type 6AR11.

DUAL TRIODE

Miniature type used in television receivers employing series-connected heater-strings. Low-μ triode unit is used as vertical-deflection amplifier; high-μ triode unit is used as vertical-deflection oscillator. Outline 8D, OUTLINES SECTION. Heater volts (ac/dc), 11; amperes, 0.45; warm-up time (average), 11 seconds. Except for heater rating, this type is identical with miniature type 6CY7.

11CY7

Related type: 6CY7



HIGH-μ TRIODE—SHARP-CUTOFF PENTODE

Miniature type with frame-grid pentode unit used in black-and-white television receivers. The triode unit is used in general-purpose voltage-amplifier, sync-separator, and sound-if-amplifier applications. The pentode unit is used as a video output tube. Outline 8D, OUTLINES SECTION. Heater volts (ac/dc), 10.9; amperes, 0.45; warm-up time (average), 11 seconds. Except for heater ratings, this type is identical with miniature type 6KV8.

11KV8

Related type: 6KV8

DETECTOR AMPLIFIER

Glass type used as detector and amplifier in battery-operated receivers. Filament volts (dc), 1.1; amperes, 0.25. Typical operation as class A₁ amplifier: plate volts, 135 max; grid volts, -10.5; plate resistance (approx.), 15500 ohms; transconductance, 440 μmhos; plate ma., 3. This is a DISCONTINUED type listed for reference only.

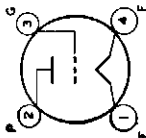

12

POWER PENTODE

Glass type used as output amplifier in ac/dc radio receivers. Maximum dimensions: over-all length, 4-3/16 inches; seated height, 3-9/16 inches; diameter, 1-9/16 inches. Heater volts (ac/dc), 12.6 (series), 6.3 (parallel); amperes, 0.3 (series), 0.6 (parallel). Typical operation as class A₁ amplifier: plate volts and grid-No.2 volts, 180 max; grid-No.1 volts, -25; plate ma., 45; grid-No.2 ma., 8; plate resistance, 35000 ohms; transconductance, 2400 μmhos; load resistance, 3300 ohms; output watts, 3.4. This is a DISCONTINUED type listed for reference only.

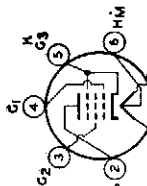

12A5

RECTIFIER—POWER PENTODE

Glass type used as combined half-wave rectifier and power amplifier. Outline 24B, OUTLINES SECTION. Tube requires small seven-contact (0.75-inch, pin-circle diameter) socket. Heater volts (ac/dc), 12.6; amperes, 0.3. Typical operation of pentode unit as class A₁ amplifier: plate volts and grid-No.2 volts, 135 max; grid-No.1 volts, -13.5; load resistance, 13500 ohms; plate resistance, 100000 ohms; transconductance, 975 μmhos; cathode-bias resistor, 1175 ohms; plate ma., 9; grid-No.2 ma., 2.5; output watts, 0.55. Maximum ratings of rectifier unit with capacitor-input filter: ac plate volts (rms), 126; dc output ma., 30. This is a DISCONTINUED type listed for reference only.

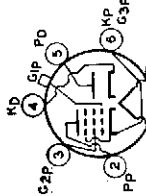

12A7

PENTAGRID CONVERTER

Glass octal type used as converter in ac/dc receivers. Outline 15A, OUTLINES SECTION. Heater volts (ac/dc), 12.6; amperes, 0.15. Except for heater rating, this type is identical with glass octal type 6A8-GT. Type 12A8-GT is used principally for renewal purposes.



12A8GT

BEAM POWER TUBE

Miniature type used in the output stage of automobile radio receivers operating from a 12-volt storage battery. Outline 8D, OUTLINES SECTION. Tube requires miniature nine-contact socket and may be mounted in any position.

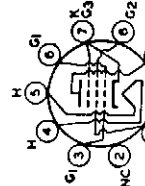

12AB5

HEATER-VOLTAGE RANGE (AC/DC)*..... 10, 0 to 15.9 volts
HEATER CURRENT (APPROX.) at 12.6 volts..... 0.2 ampere
DIRECT INTERELECTRODE CAPACITANCES:
 Grid No.1 to Plate..... 0.7 *max* pf
 Grid No.1 to Cathode, Heater, Grid No.2, and Grid No.3..... 8 pf
 Plate to Cathode, Heater, Grid No.2, and Grid No.3..... 8.5 pf

* For longest life, it is recommended that the heater be operated within the voltage range of 11 to 14 volts.

CLASS A₁ AMPLIFIER

Maximum Ratings, (Design-Center Values):

PLATE VOLTAGE.....	315 <i>max</i> volts
GRID-NO.2 (SCREEN-GRID) VOLTAGE.....	285 <i>max</i> volts
PLATE DISSIPATION.....	12 <i>max</i> watts
GRID-NO.2 INPUT.....	2 <i>max</i> watts
PEAK HEATER-CATHODE VOLTAGE:	
Heater negative with respect to cathode.....	90 <i>max</i> volts
Heater positive with respect to cathode.....	90 <i>max</i> volts
BULB TEMPERATURE (At hottest point)	250 <i>max</i> °C

Typical Operation with 12.6 Volts on Heater:

Plate Supply Voltage.....	250 volts
Grid-No.2 Supply Voltage.....	250 volts
Grid-No.1 (Control-Grid) Voltage.....	-12.5 volts
Cathode-Bias Resistor.....	45 ohms
Peak AF Grid-No.1 Current.....	12.5 ma
Zero-Signal Plate Current.....	46 ma
Maximum-Signal Plate Current.....	33.6 ma
Zero-Signal Grid-No.2 Current.....	36 ma
Maximum-Signal Grid-No.2 Current.....	4.5 ma
Plate Resistance (Approx.).....	75000 ohms
Transconductance.....	4100 amhos
Load Resistance.....	6000 ohms
Total Harmonic Distortion.....	8 per cent
Maximum-Signal Power Output.....	3.8 watts

Maximum Circuit Values:

Grid-No.1-Circuit Resistance:	0.1 <i>max</i> megohm
For fixed-bias operation.....	0.5 <i>max</i> megohm
For cathode-bias operation.....	

PUSH-PULL CLASS AB₁ AMPLIFIER

Maximum Ratings: (Same as for single-tube class A₁ amplifier)

Typical Operation with 12.6 Volts on Heater (Values are for two tubes):

Plate Voltage.....	250 volts
Grid-No.2 Voltage.....	250 volts
Grid-No.1 Voltage.....	-15 volts
Peak AF Grid-No.1-to-Grid-No.1 Voltage.....	30 volts
Zero-Signal Plate Current.....	70 ma
Maximum-Signal Plate Current.....	79 ma
Zero-Signal Grid-No.2 Current.....	15 ma
Maximum-Signal Grid-No.2 Current.....	13 ma

AVERAGE CHARACTERISTICS

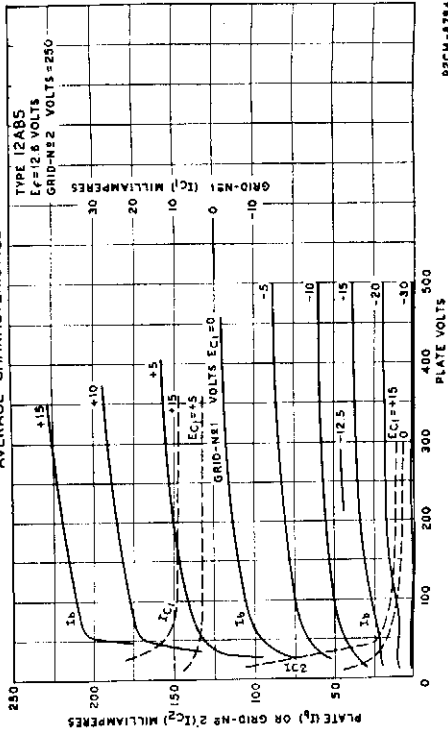

Effective Load Resistance (Plate-to-plate).....	10000 ohms
Total Harmonic Distortion.....	5 per cent
Maximum-Signal Power Output.....	10 watts

Maximum Circuit Values:

Grid-No.1-Circuit Resistance:	0.1 <i>max</i> megohm
For fixed-bias operation.....	0.5 <i>max</i> megohm
For cathode-bias operation.....	

REMOTE-CUTOFF PENTODE

Miniature type used as rf and if amplifier in automobile receivers operating from a 12-volt storage battery. Outline 7B, OUTLINES SECTION. Tube requires miniature seven-contact socket. Heater-voltage range (ac/dc), 10 to 15.9; amperes at 12.6 volts, 0.15. Characteristics as class A₁ amplifier: heater volts, 12.6; plate and grid-No.2 volts, 12.6 (30 *max*); grid No.3 and grid-No.1 volts, 12.6 (30 *max*); grid-No.1 volts, connected to cathode at socket; grid-No.1 volts, 0; grid-No.1 resistor (bypassed), 2.2 megohms; plate resistance (approx.), 0.5 megohm; transconductance, 730 amhos; plate ma., 0.55; grid-No.2 ma., 0.2; cathode ma., 20 *max*; peak heater-cathode volts, 30 *max*. This type is used principally for renewal purposes.

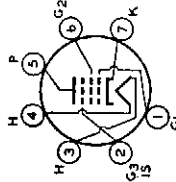

PENTAGRID CONVERTER

Miniature type used as combined oscillator and mixer in low B + voltage automobile radio receivers operating directly from a 12-volt storage-battery system. Outline 7B, OUTLINES SECTION. Tube requires miniature seven-contact socket. Heater-voltage range (ac/dc), 10 to 15.9; amperes at 12.6 volts, 0.15. Typical operation in converter service: heater volts, 12.6; plate and grids-No.2-and-No.4 volts, 12.6 (16 *max*); grid-No.1 volts (peak-to-peak), 4.5; grid-No.3 resistor, 2.2 megohms; grid-No.1 resistor, 33000 ohms; plate resistance (approx.), 0.4 megohm; conversion transconductance, 320 amhos; plate ma., 0.35; grids-No.2-and-No.4 ma., 1.5; grid-No.1 ma., 0.06; total cathode ma., 1.6 (30 *max*); peak heater-cathode volts, 16 *max*. This type is used principally for renewal purposes.

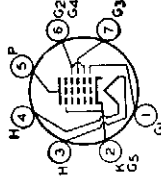

TWIN DIODE—MEDIUM-MU TRIODE

Miniature types used as combined detector and af voltage amplifier in automobile radio receivers operating from a 12-volt storage battery. Outline 7B, OUTLINES SECTION. Tubes require miniature seven-contact socket. Heater-voltage range (ac/dc), 10 to 15.9; amperes at 12.6 volts, 0.15. Characteristics of triode unit as class A₁ amplifier: heater volts, 12.6; plate volts, 12.6 (30 *max*); grid volts, 0; plate resistance (approx.), 13000 ohms; amplification factor, 16.7; transconductance, 1300 amhos; plate ma., 1; total cathode ma., 20 *max*. Maximum diode plate ma. (each unit), 1 *max*. Peak heater-cathode volts, 30 *max*. Type 12AE6 is a DISCONTINUED type listed for reference only. Type 12AE6-A is used principally for renewal purposes.

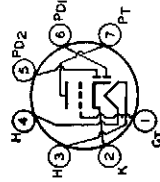

DUAL TRIODE

Miniature type with medium-mu and low-mu triode units used as transistor-driver in audio-output stage of hybrid car radios. Outline 8B, OUTLINES SECTION. Tube requires miniature nine-contact socket. Heater-voltage range (ac/dc), 10 to 15.9; amperes at 12.6 volts, 0.45. Characteristics as class A₁ amplifier: heater volts, 12.6; plate volts, 12.6; grid resistor, 1.5 megohms (unit No.1), 1 megohm (unit No.2); amplification factor, 13 (unit No.1), 6.4 (unit No.2); plate resistance (approx.), 3150 ohms (unit No.1), 985 ohms (unit No.2); transconductance, 4000 amhos (unit No.1), 6500 amhos (unit No.2); plate ma., 1.9 (unit No.1), 7.5 (unit No.2). Maximum ratings as audio driver (each unit): plate volts, 16 *max*; grid volts, 0 *max*; plate dissipation, 1 *max* watt; peak heater-cathode volts, 16 *max*. This type is used principally for renewal purposes.

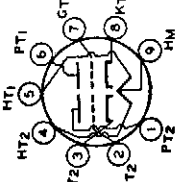

12AF3

Related types:
6AF3

volts (ac/dc), 12.6; grid-No. 12, 0.6; warm-up time (average), 11 seconds. Except for heater ratings, this type is identical with miniature type 6AF3.

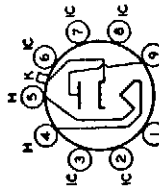

HALF-WAVE VACUUM RECTIFIER

Miniature type used as a damper tube in horizontal-deflection circuits of television receivers employing series-connected heater strings. Outline 9B, OUTLINES SECTION. Heater

REMOTE-CUTOFF PENTODE

Miniature type used as if and rf amplifier in automobile radio receivers operating from a 12-volt storage battery. Outline 7B, OUTLINES SECTION. Tube requires miniature seven-contact socket. Heater-voltage range (ac/dc), 10 to 15.9; amperes at 12.6 volts, 0.15. Characteristics as class A₁ amplifier: heater volts, 12.6; plate and grid-No.2 volts, 12.6 (16 max.); grid-No.3 connected to cathode at socket; 0.35 megohm; transconductance, 1500 μ mhos; plate ma., 1.1; grid-No.2 ma., 0.45; peak heater-cathode volts, 16 max. This type is used principally for renewal purposes.

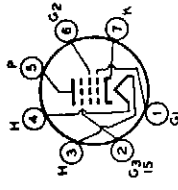

MEDIUM-MU TWIN TRIODE

Glass octal tube used as audio amplifier in radio equipment. Outline 14B, OUTLINES SECTION, except over-all length is 3-1/16 max inches and seated length is 2-1/2 inches. Tube requires octal socket. Heater volts (ac/dc), 12.6; amperes, 0.15. Characteristics and maximum ratings (each unit) as class A₁ amplifier: plate volts, 180 max; grid volts, -6.5; amplification factor, 15; transconductance, 1900 μ mhos; plate resistance (approx.), 8400 ohms; plate ma., 7.5. This type is used principally for renewal purposes.

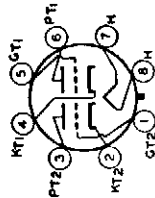

TWIN DIODE—HIGH-MU TRIODE

Miniature type used as combined detector and af voltage amplifier in automobile radio receivers operating from a 12-volt storage battery. Outline 7B, OUTLINES SECTION. Tube requires miniature seven-contact socket. Heater-voltage range (ac/dc), 10 to 15.9 volts; amperes at 12.6 volts, 0.15. Characteristics with triode volts of 12.6 and maximum ratings of triode unit as class A₁ amplifier: plate volts, 12.5 (30 max); grid volts, 0; amplification factor, 55; plate resistance (approx.), 4500 ohms; transconductance, 1200 μ mhos; plate ma., 0.75; total cathode ma., 20 max; peak heater-cathode volts, 30 max. Maximum rating of each diode unit: plate ma., 1 max. This type is used principally for renewal purposes.

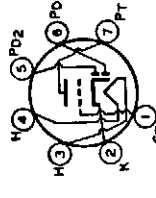

TWIN DIODE

Miniature, high-perveance type used as detector in FM and television circuits. It is especially useful as a ratio detector in ac/dc FM receivers. Outline 7A, OUTLINES SECTION. Heater volts (ac/dc), 12.6; amperes, 0.15. Except for heater rating, this type is identical with miniature type 6AL5.

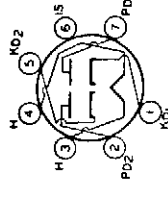

12AL5

Related types:
3AL5, 6AL5

12AL8

MEDIUM-MU TRIODE—POWER TETRODE

Miniature type used in automobile-radio receivers operating from a 12-volt storage battery. The triode unit performs the trigger function and the tetrode unit performs the relay-actuating function in automatic station-selection circuits. Outline 8D, OUTLINES SECTION. Tube requires miniature nine-contact socket. Heater-voltage range (ac/dc), 10 to 15.9; amperes at 12.6 volts, 0.55. Characteristics

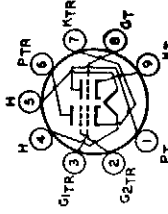

of triode unit as class A₁ amplifier: heater volts, 12.6; plate volts, 12.6 (30 max); grid volts (developed across 2.2-megohm resistor), -0.9; amplification factor, 13; plate resistance (approx.), 13000 ohms; transconductance, 1000 μ mhos; plate ma., 0.5; cathode ma., 20 max. Tetrode unit: heater volts, 12.6; plate volts, 12.6 (30 max); grid-No.1 (space-charge-grid) volts, 12.5 (16 absolute max); grid-No.2 (control-grid) volts, (developed across 2.2-megohm resistor), -0.5 (-20 max); amplification factor (grid No.2 to plate), 12; plate resistance (approx.), 480 ohms; transconductance (grid No.2 to plate), 16000 μ mhos; plate ma., 40; grid-No.1 ma., 7.5. Peak heater-cathode volts, 30 max. This type is used principally for renewal purposes.

BEAM POWER TUBE—SHARP-CUTOFF PENTODE

Duodecar type used as FM detector and audio-frequency output amplifier in television receivers employing series-connected heater strings. Outline 12B, OUTLINES SECTION.

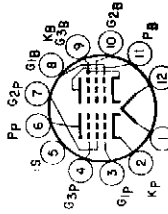

Heater volts (ac/dc), 12.6; amperes, 0.45; warm-up time (average), 11 seconds. Except for heater ratings, this type is identical with duodecar type 6AL11.

12AL11

Related type:
6AL11

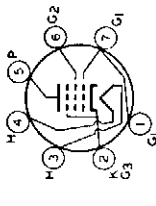

BEAM POWER TUBE

Miniature type used as output amplifier primarily in automobile radio receivers operating from a 12-volt storage battery. Outline 7C, OUTLINES SECTION. Heater volts (ac/dc), 12.6; amperes, 0.225. Except for heater ratings, this type is identical with miniature type 6AQ5. Within its maximum ratings, the performance of the 12AQ5 is equivalent to that of the larger type 12V6-GT.

12AQ5

Related types:
5AQ5, 6AQ5A

12AJ6

grid volts, 0; amplification factor, 55; plate resistance (approx.), 4500 ohms; transconductance, 1200 μ mhos; plate ma., 0.75; total cathode ma., 20 max; peak heater-cathode volts, 30 max. Maximum rating of each diode unit: plate ma., 1 max. This type is used principally for renewal purposes.

TWIN DIODE—HIGH-MU TRIODE

Miniature type used as combined detector, amplifier, and ave tube in compact ac/dc radio receivers. Outline 7B, OUTLINES SECTION. Heater volts (ac/dc), 12.6; amperes, 0.15. Except for heater ratings, this type is identical with miniature type 6AT6.

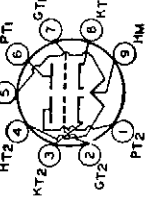
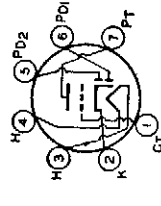

HIGH-MU TWIN TRIODE

Miniature type used as push-pull cathode-drive amplifier or frequency converter in the FM and television broadcast bands. Outline 8B, OUTLINES SECTION. Tube requires miniature nine-contact socket and may be mounted in any position. Each triode

unit is independent of the other except for the common heater. For typical operation as a resistance-coupled amplifier, refer to RESISTANCE-COUPLED AMPLIFIER SECTION.

HEATER ARRANGEMENT:	Series	Parallel	volts
HEATER VOLTAGE (AC/DC)	12.6	6.3	
HEATER CURRENT	0.15	0.3	ampere
DIRECT INTERELECTRODE CAPACITANCES:			
Grid-Drive Operation:			pf
Grid to Plate (Each unit)	1.6		
Grid to Cathode and Heater (Each unit)	2.2		
Plate to Cathode and Heater:			pf
Unit No.1	0.5		
Unit No.2	0.4		
Cathode-Drive Operation:			pf
Cathode to Plate (Each unit)	0.2		
Cathode to Grid and Heater (Each unit)	4.6		
Plate to Grid and Heater (Each unit)	1.8		
Heater to Cathode (Each unit)	2.4		

CLASS A₁ AMPLIFIER (Each Unit)

Maximum Ratings, (Design-Center Values):			
PLATE VOLTAGE	300 max	volts	
GRID VOLTAGE, Negative-bias value	-60 max	volts	
PLATE DISSIPATION	2.5 max	watts	
PEAK HEATER-CATHODE VOLTAGE:		volts	
Heater negative with respect to cathode	90 max	volts	
Heater positive with respect to cathode	90 max	volts	
Characteristics:			
Plate Supply Voltage	100	volts	
Cathode-Bias Resistor	270	ohms	
Amplification Factor	60		
Plate Resistance (Approx.)	16000	ohms	
Transconductance	4000	μmhos	
Grid Voltage (Approx.) for plate current of 10 μa	-5	volts	
Plate Current	3.7	ma	

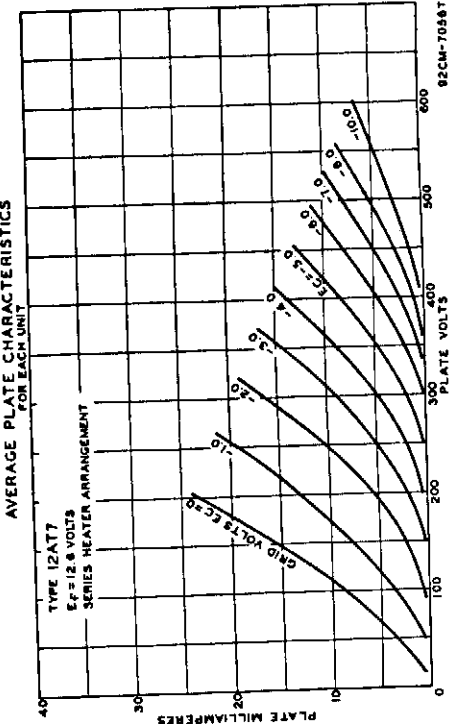

SHARP-CUTOFF PENTODE

Miniature type used in compact ac/dc radio equipment as an rf amplifier especially in high-frequency, wide-band applications. Outline 7B, OUTLINES SECTION. Heater volts (ac/dc), 12.6; amperes, 0.15. Except for heater ratings, this type is identical with miniature type 6AU6.

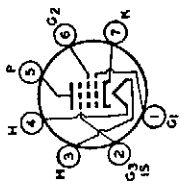

12AU6

Related types: 3AU6, 4AU6, 6AU6A

MEDIUM-μ TWIN TRIODE

Miniature types used as phase inverter or push-pull amplifier in ac/dc radio equipment and in diversified applications such as multivibrators or oscillators in industrial control devices. Also used as combined vertical oscillator and vertical deflection amplifier, and as horizontal deflection oscillator, in television receivers. The 12AU7-A is also useful in applications critical as to microphonics. Outline 8B, OUTLINES SECTION. Tubes require miniature nine-contact socket and may be mounted in any position. Each triode unit is independent of the other except for the common heater. For typical operation as a resistance-coupled amplifier, refer to RESISTANCE-COUPLED AMPLIFIER SECTION. Type 12AU7 is a DISCONTINUED type listed for reference only.

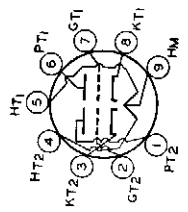

12AU7
12AU7A

Related types: 7AU7, 9AU7

HEATER ARRANGEMENT:	Series	Parallel	volts
HEATER VOLTAGE (AC/DC)	12.6	6.3	
HEATER CURRENT	0.15	0.3	ampere
DIRECT INTERELECTRODE CAPACITANCES for 12AU7-A (Approx.): Unit No.1			
Grid to Plate	1.6	1.6	pf
Grid to Cathode and Heater	1.8	1.6	pf
Plate to Cathode and Heater	0.5	0.35	pf
CLASS A ₁ AMPLIFIER (Each Unit Unless Otherwise Specified)			
Maximum Ratings for 12AU7-A, (Design-Maximum Values):			
PLATE VOLTAGE	330 max	volts	
PLATE DISSIPATION:		watts	
Each Plate	2.75 max	watts	
Both Plates (Both units operating)	5.5 max	watts	
CATHODE CURRENT	22 max	ma	
PEAK HEATER-CATHODE VOLTAGE:		volts	
Heater negative with respect to cathode	200 max	volts	
Heater positive with respect to cathode	200 max	volts	
• The dc component must not exceed 100 volts.			

Characteristics for 12AU7-A:

Plate Voltage	100	250	volts
Grid Voltage	0	-8	volts
Amplification Factor	19.5	17	
Plate Resistance (Approx.)	6250	7700	ohms
Transconductance	3100	2200	μmhos
Plate Current	11.8	10.5	ma
Grid Voltage (Approx.) for plate current of 10 μa	-	-24	volts

AVERAGE PLATE CHARACTERISTICS

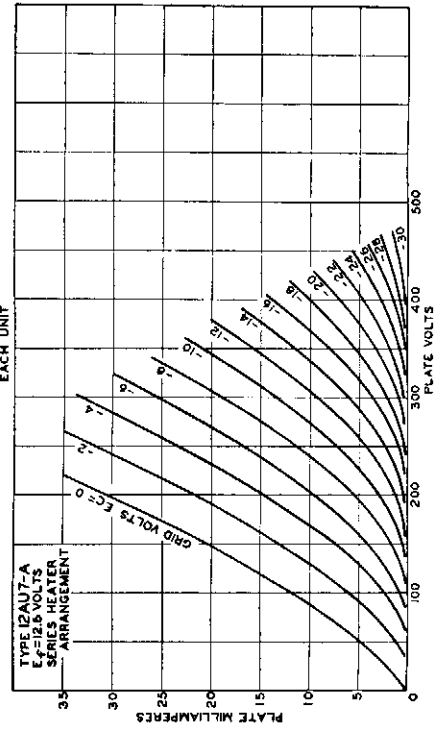

Maximum Circuit Values:

Grid-Circuit Resistance:	0.25 max	megohm
For fixed-bias operation:	1.0 max	megohm
For cathode-bias operation:		

OSCILLATOR (Each Unit, Unless Otherwise Specified)

<i>For operation in a 525-line, 30-frame system</i>		
Vertical-Deflection Oscillator		
DC PLATE VOLTAGE:	330 max	volts
PEAK NEGATIVE-PULSE GRID VOLTAGE:	-440 max	volts
PEAK CATHODE CURRENT:	66 max	ma
AVERAGE CATHODE CURRENT:	22 max	ma
PLATE DISSIPATION:	2.75 max	watts
Each Plate:	5.5 max	watts
Both Plates (Both units operating):	200 max	volts
PEAK HEATER-CATHODE VOLTAGE:	200 max	volts
Heater negative with respect to cathode:		
Heater positive with respect to cathode:		
Maximum Circuit Values:		
Grid-Circuit Resistance:	2.2 max	megohms

VERTICAL-DEFLECTION AMPLIFIER (Each Unit Unless Otherwise Specified)

<i>For operation in a 525-line, 30-frame system</i>		
Maximum Ratings for 12AU7-A, (Design-Maximum Values):		
DC PLATE VOLTAGE:	330 max	volts
PEAK POSITIVE-PULSE PLATE VOLTAGE:	1200 max	volts
PEAK NEGATIVE-PULSE PLATE VOLTAGE:	-975 max	volts
PEAK CATHODE CURRENT:	68 max	ma
AVERAGE CATHODE CURRENT:	22 max	ma
PLATE DISSIPATION:	2.75 max	watts
Each Plate:	5.5 max	watts
Both Plates (Both units operating):	200 max	volts
PEAK HEATER-CATHODE VOLTAGE:	200 max	volts
Heater negative with respect to cathode:		
Heater positive with respect to cathode:		

Maximum Circuit Values:

Grid-Circuit Resistance:	2.2 max	megohms
For cathode-bias operation:		
# The duration of the voltage pulse must not exceed 15 per cent of one vertical scanning cycle. In a 525-line, 30-frame system, 15 per cent of one vertical scanning cycle is 2.5 milliseconds.		
# The dc component must not exceed 100 volts.		

BEAM POWER TUBE

Glass octal type used as horizontal deflection amplifier in television receivers employing series-connected heater strings. Outline 19B, OUTLINES SECTION. Heater volts (ac/dc), 12.6; amperes, 0.6; warm-up time (average), 11 seconds. Except for heater ratings, this type is identical with glass octal type 6AV5-GA.

12AV5GA

Related types:
6AV5GA, 25AV5GA

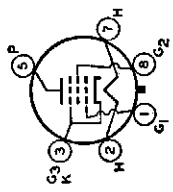

TWIN DIODE—HIGH-MU TRIODE

Miniature type used as combined detector, amplifier, and avc tube in automobile and ac-operated receivers. Outline 7B, OUTLINES SECTION. Heater volts (ac/dc), 12.6; amperes, 0.15. Except for heater ratings, this type is identical with miniature type 6AV6.

12AV6

Related types:
3AV6, 4AV6, 6AV6

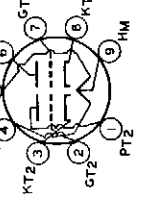
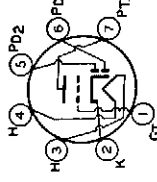

MEDIUM-MU TWIN TRIODE

Miniature type used as frequency converter in vhf tuners of television receivers, and as rf amplifier, oscillator, or mixer. Outline 8B, OUTLINES SECTION. Tube requires miniature nine-contact socket. Heater volts (ac/dc), 12.6 (series), 6.3 (parallel); amperes, 0.225 (series), 0.45 (parallel). Characteristics as class A₁ amplifier (each unit): plate volts, 150 (300 max); cathode-bias resistor, 56 ohms; amplification factor, 41; plate resistance (approx.), 4800 ohms; transconductance, 8500 μmhos; plate ma., 18; plate dissipation, 2.7 max watts; peak heater-cathode volts, 90 max. This type is used principally for renewal purposes.

12AV7

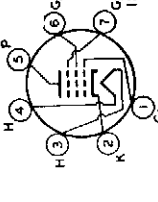

SHARP-CUTOFF PENTODE

Miniature type used as an rf or if amplifier up to 400 megacycles in compact ac/dc FM receivers. Outline 7B, OUTLINES SECTION. Tube requires miniature seven-contact socket. Heater volts (ac/dc), 12.6; amperes, 0.15. Except for heater ratings and terminal connections, this type is identical with miniature type 6AG5.

12AW6

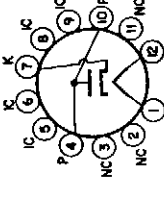

HALF-WAVE VACUUM RECTIFIER

Duodecal type used as damper tube in horizontal-deflection circuits of television receivers employing series-connected heater strings. Outline 12C, OUTLINES SECTION. Heater volts (ac/dc), 12.6; amperes, 0.6; warm-up time (average), 11 seconds. Except for heater ratings, this type is identical with duodecal type 6AX3.

12AX3

Related types:
6AX3, 17AX3

HALF-WAVE VACUUM RECTIFIER

Glass octal types used as damper tubes in horizontal deflection circuits of television receivers. Types 12AX4-GTA and 12AX4-GTB have a controlled heater warm-up time for use in series-connected heater strings. Outline 14C, OUTLINES SECTION. These types may be supplied with pin No.1 omitted. Heater volts (ac/dc), 12.6; amperes, 0.6; warm-up time (average) for 12AX4-GTA and 12AX4-GTB, 11 seconds. Except for heater rating, these types are identical with glass octal type 6AX4-GT. Type 12AX4-GT is a DISCONTINUED type listed for reference only.

12AX4GT

12AX4GTA

12AX4GTB

Related types:
6AX4GT, 6AX4GTB,
17AX4GT, 17AX4GTA,
25AX4GTA

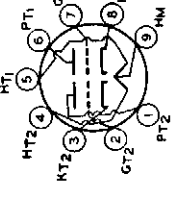
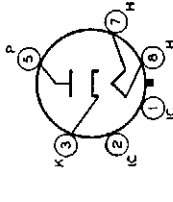

HIGH-MU TWIN TRIODE

Miniature types used as phase inverter or twin resistance-coupled amplifier in radio equipment. The 12AX7 is also used in diversified applications such as multivibrators or oscillators in industrial control devices. Type 12AX7-A has controlled hum and noise characteristics and is used in high-fidelity audio-amplifier applications. Outline 8B, OUTLINES SECTION. Tube requires miniature nine-contact socket and may be mounted in any position. Each triode unit is independent of the other except for

12AX7

12AX7A

common heater. For characteristics and curves, refer to type 6AV6. For typical operation as a resistance-coupled amplifier, refer to RESISTANCE-COUPLED AMPLIFIER SECTION.

HEATER ARRANGEMENT:	Series	Parallel	volts
HEATER VOLTAGE (AC/DC):	12.6	6.3	6.3
HEATER CURRENT:	0.15	0.3	ampere
DIRECT INTERELECTRODE CAPACITANCES (Approx.):			
Grid to Plate (Each unit)	Unit No. 1	Unit No. 2	pf
Grid to Cathode and Heater (Each unit)	1.6	1.6	pf
Plate to Cathode and Heater	0.46	0.34	pf

CLASS A₁ AMPLIFIER (Each Unit)

Maximum Ratings, (Design-Maximum Values):	
PLATE VOLTAGE:	330 max
PLATE DISSIPATION:	1.2 max
GRID VOLTAGE:	0 max
Negative-bias value:	-55 max
PEAK HEATER-CATHODE VOLTAGE:	200 max
Heater negative with respect to cathode:	200 max
Heater positive with respect to cathode:	200 max
The dc component must not exceed 100 volts.	

Equivalent Noise and Hum Voltage, (Reference to Grid, Each Unit):*

Average Value:	1.8	μvolts rms
* Measured in "true rms" units under the following conditions: Heater voltage (parallel connection), 6.3 volts ac; center tap of heater transformer grounded; plate supply voltage, 250 volts dc; plate-load resistor, 100,000 ohms; cathode resistor, 2700 ohms bypassed by 100-μf capacitor; grid resistor, 0 ohms; and amplifier covering frequency range between 25 and 10,000 cps.		

HALF-WAVE VACUUM RECTIFIER

Novar type used as damper tube in horizontal-deflection circuits of black-and-white television receivers. Tube has controlled warm-up time for use in series-connected heater strings.

Outline 17A, OUTLINES SECTION. Heater volts (ac/dc), 12.6; amperes, 0.6; warm-up time (average), 11 seconds. Except for heater rating, this type is identical with novar type 6AY3.

MEDIUM-MU TWIN TRIODE

Miniature type used in the first stages of high-gain audio-frequency amplifiers where reduction of microphonics, leakage noise, and hum are primary considerations. Outline 8B, OUTLINES SECTION. Tube requires miniature nine-contact socket and may be mounted in any position. Each triode unit is independent of the other except for the common heater. Use of the 12.6-volt connection with an ac heater supply is not recommended for applications involving low hum. For typical operation as a resistance-coupled amplifier, refer to RESISTANCE-COUPLED AMPLIFIER SECTION.

HEATER ARRANGEMENT:	Series	Parallel	volts
HEATER VOLTAGE (AC/DC):	12.6	6.3	6.3
HEATER CURRENT:	0.15	0.3	ampere
AMPLIFICATION FACTOR (Each unit)*	44	44	
PLATE RESISTANCE (Each unit, approx.)*	25000	25000	ohms
TRANSCONDUCTANCES*	1750	1750	μmhos
* For plate volts, 250; grid volts, -4; plate ma., 3.			

CLASS A₁ AMPLIFIER (Each Unit)

Maximum Ratings (Design-Center Values):	
PLATE VOLTAGE:	300 max
GRID VOLTAGE:	-50 max
Negative bias value:	0 max
Positive bias value:	

12AY3

Related types: 6AY3, 17AY3

12AY7

PLATE DISSIPATION:	1.5 max	watts
CATHODE CURRENT:	10 max	ma
PEAK HEATER-CATHODE VOLTAGE:	80 max	volts
Heater negative with respect to cathode:	90 max	volts
Heater positive with respect to cathode:		

HIGH-MU TWIN TRIODE

Miniature types used in direct-coupled cathode-drive rf amplifier circuits of vhf television tuners. Outline 8B, OUTLINES SECTION. Tubes require miniature nine-contact socket

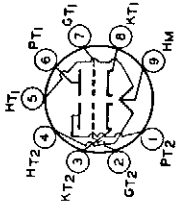

and may be mounted in any position. Heater volts (ac/dc): 12.6 (series), 6.3 (parallel); amperes, 0.225 (series), 0.45 (parallel); warm-up time (average), 12AZ7-A, 11 seconds. Type 12AZ7 is a DISCONTINUED type listed for reference only. For characteristics, class A₁ amplifier, refer to miniature type 12AT7.

DIRECT INTERELECTRODE CAPACITANCES (Approx.):	Without External Shield	With External Shield*
Grid to Plate (Each unit)	2	1.9
Grid to Cathode and Heater (Each unit)	2.6	2.8
Plate to Cathode and Heater:		
Unit No. 1	0.44	1.4
Unit No. 2	0.36	1.6
* With external shield connected to cathode of unit under test.		

CLASS A₁ AMPLIFIER (Each Unit)

Maximum Ratings:	12AZ7 Values	12AZ7-A Design-Maximum Values
PLATE VOLTAGE:	300 max	300 max
GRID VOLTAGE, Negative-bias value:	-50 max	390 max
PLATE DISSIPATION:	2.5 max	-55 max
PEAK HEATER-CATHODE VOLTAGE:	200 max	2.5 max
Heater negative with respect to cathode:	200 max	200 max
Heater positive with respect to cathode:	200 max	200 max
The dc component must not exceed 100 volts.		

Maximum Circuit Values (Each Unit):

Grid-Circuit Resistance:	0.25 max	megohm
For fixed-bias operation:	1 max	megohm
For cathode-bias operation:		

LOW-MU TRIODE

Miniature type having high performance used as vertical deflection amplifier in television receivers. This type has a controlled heater warm-up time for use in series-connected heater

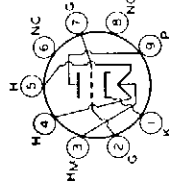

strings. Outline 8D, OUTLINES SECTION. Tube requires miniature nine-contact socket and may be mounted in any position. Heater volts (ac/dc), 12.6 (series), 6.3 (parallel); amperes, 0.3 (series), 0.6 (parallel); warm-up time (average), 11 seconds.

CLASS A₁ AMPLIFIER

Maximum Ratings, (Design-Center Values):	
PLATE VOLTAGE:	550 max
GRID VOLTAGE, Negative-bias value:	-50 max
PLATE DISSIPATION:	5.5 max
PEAK HEATER-CATHODE VOLTAGE:	200 max
Heater negative with respect to cathode:	200 max
Heater positive with respect to cathode:	200 max

Characteristics:

Plate Voltage:	150	volts
Grid Voltage:	-17.5	volts
Amplification Factor:	6.5	
Plate Resistance (Approx.):	1090	ohms

Amplification Factor.....	16.5	ohms
Plate Resistance (Approx.).....	5300	amperes
Transconductance.....	3100	volts
Grid Voltage (Approx.) for plate current of 50 ma.....	-23	ma
Plate Current.....	11.5	ma
Plate Current for grid voltage of -14 volts.....	4	
Maximum Circuit Values:		
Grid-Circuit Resistance:	0.25 maz	megohm
For fixed-bias operation.....	1.0 maz	megohm
For cathode-bias operation.....		

OSCILLATOR (Each Unit)

For operation in a 525-line, 30-frame system

Vertical Deflection Oscillator.....	450 maz	volts
DC PLATE VOLTAGE.....	450 maz	volts
PEAK NEGATIVE-PULSE GRID VOLTAGE.....	-400 maz	ma
PEAK CATHODE CURRENT.....	70 maz	ma
AVERAGE CATHODE CURRENT.....	20 maz	ma
PLATE DISSIPATION:		watts
Each Plate.....	3.5 maz	watts
Both Plates (Both units operating).....	7 maz	watts
PEAK HEATER-CATHODE VOLTAGE.....	200 ^o maz	volts
Heater negative with respect to cathode.....	200 ^o maz	volts
Heater positive with respect to cathode.....		
Maximum Circuit Values:		
Grid-Circuit Resistance.....	2.2 maz	megohms

VERTICAL DEFLECTION AMPLIFIER (Each Unit)

For operation in a 525-line, 30-frame system

DC PLATE VOLTAGE.....	450 maz	volts
PEAK POSITIVE-PULSE PLATE VOLTAGE# (Absolute maximum).....	1500 maz	volts
PEAK NEGATIVE-PULSE GRID VOLTAGE.....	-250 maz	ma
PEAK CATHODE CURRENT.....	70 maz	ma
AVERAGE CATHODE CURRENT.....	20 maz	ma
PLATE DISSIPATION:		watts
Each Plate.....	3.5 maz	watts
Both Plates (Both units operating).....	7 maz	watts
PEAK HEATER-CATHODE VOLTAGE:		volts
Heater negative with respect to cathode.....	200 maz	volts
Heater positive with respect to cathode.....	200 ^o maz	volts

Maximum Circuit Values:

- Grid-Circuit Resistance: 2.2 maz megohms
- For cathode-bias operation.....
- # The duration of the voltage pulse must not exceed 15 per cent of one vertical scanning cycle. In a 525-line, 30-frame system, 15 per cent of one vertical scanning cycle is 2.5 milliseconds.
- Under no circumstances should this absolute value be exceeded.
- The dc component must not exceed 100 volts.

AVERAGE PLATE CHARACTERISTICS

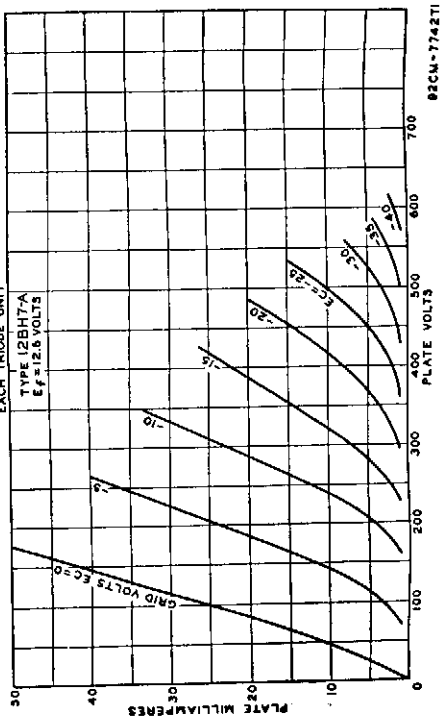

BEAM POWER TUBE

Miniature type used in audio output stages of television and radio receivers employing series-connected heater strings. Outline 8D, OUTLINES SECTION. Heater volts (ac/dc), 12.6; amperes, 0.6; warm-up time (average), 11 seconds. Peak heater-cathode volts, 200 maz. When the heater is positive with respect to the cathode, the dc component of the heater-cathode voltage must not exceed 100 volts. Except for heater and heater-cathode ratings, this type is identical with miniature type 6BK5. Type 12BK5 is used principally for renewal purposes.

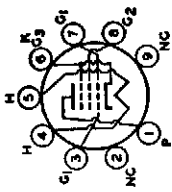

12BK5
Related types:
6BK5, 25BK5

REMOTE-CUTOFF PENTODE

Miniature type used as if and rf amplifier in automobile radio receivers operating from a 12-volt storage battery. Outline 7B, OUTLINES SECTION. Tube requires miniature seven-contact socket. Heater-voltage range (ac/dc), 10 to 15.9; amperes at 12.6 volts, 0.15. Characteristics as class A₁ amplifier; heater volts, 12.6; plate and grid-No.2 volts, 12.6 (30 maz); grid No.3 connected to cathode at socket; grid-No.1 volts, 0 maz; grid-No.1 resistor, 2.2 megohms, plate resistance (approx.), 0.5 megohm; transconductance, 1350 amhos; plate ma., 1.35; grid-No.2 ma., 0.5; cathode ma., 20 maz; peak heater-cathode volts, 30 maz. This type is used principally for renewal purposes.

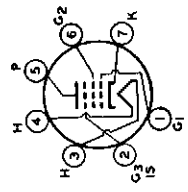

12BL6

BEAM POWER TUBE

Glass octal type used as horizontal-deflection amplifier in television receivers employing series-connected heater strings. Outline 15C, OUTLINES SECTION. This type may be supplied with pin No.1 omitted. Heater volts (ac/dc), 12.6; amperes, 0.6; warm-up time (average), 11 seconds. Except for heater ratings, this type is identical with glass octal type 6BQ6-GTB/6CU6.

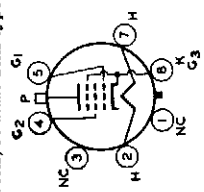

12BQ6GTB / 12CU6
Related types:
6BQ6GTB/6CU6, 17BQ6GTB,
35BQ6GTB/35CU6

TWIN DIODE—HIGH-MU TRIODE

Miniature type used as combined sync separator and horizontal phase detector in television receivers. Outline 8B, OUTLINES SECTION. Tube requires miniature nine-contact socket. Heater volts (ac/dc), 12.6 (series), 6.3 (parallel); amperes, 0.225 (series), 0.45 (parallel). For maximum ratings, characteristics, and curves of triode unit, refer to type 12AT7. Maximum ratings of diode units (each unit): peak in reverse plate volts, 300 maz; peak heater-cathode volts, 200 maz (the dc component must not exceed 100 volts). Type 12BR7 is used principally for renewal purposes.

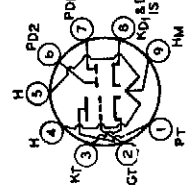

12BR7

HALF-WAVE VACUUM RECTIFIER

Novar type used as damper tube in horizontal-deflection circuits of black-and-white television receivers employing series-connected heater strings. Outline 10D, OUTLINES SECTION. Heater volts (ac/dc), 12.6; amperes, 0.6; warm-up time (average), 11 seconds. Except for heater ratings, this type is identical with novar type 6BS3.

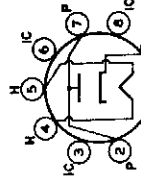

12BS3
Related types:
6BS3, 17BS3

12BV7

Miniature type used as video amplifier in television receivers. Outline 8D, OUTLINES SECTION. Tube requires miniature nine-contact socket. Heater volts (ac/dc), 12.6 (series), 6.3 (parallel); amperes, 0.3 (series), 0.6 (parallel). Maximum ratings as class A₁ amplifier: plate volts, 300 *max*; grid-No.3 volts, 0 *max*; grid-No.2 volts, 175 *max*; grid-No.1 volts, -50 *max*; plate dissipation, 6.25 *max* watts; grid-No.2 input, 1 *max* watt; peak heater-cathode volts, 200 *max* (the dc component must not exceed 100 volts). This type is used principally for renewal purposes.

SHARP-CUTOFF PENTODE

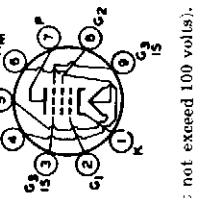

12BW4

Related type:
6BW4

Miniature type used in full-wave power supplies having high dc output current requirements. Outline 8D, OUTLINES SECTION. Type 12BW4 requires miniature nine-contact socket and may be mounted in any position. Heater volts (ac/dc), 12.6; amperes 0.45. It is especially important that this tube, like other power-handling tubes, be adequately ventilated. Except for heater ratings, this type is identical with miniature type 6BW4.

FULL-WAVE VACUUM RECTIFIER

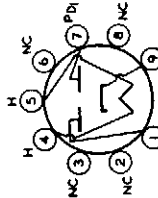

12BY7

12BY7A

SHARP-CUTOFF PENTODE

Miniature types used as video amplifier in television receivers. Type 12BY7-A has a controlled heater warm-up time for use in series-connected heater strings. Outline 8D, OUTLINES SECTION. Tubes require miniature nine-contact socket and may be mounted in any position. Type 12BY7 is a DISCONTINUED type listed for reference only.

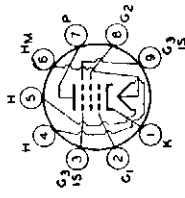

HEATER ARRANGEMENT:	Series	volts
HEATER VOLTAGE (AC/DC):	12.6	amperes
HEATER CURRENT:	0.3	seconds
HEATER WARM-UP TIME (Average) for 12BY7-A:	—	
DIRECT INTERELECTRODE CAPACITANCES:		pf
Grid No.1 to Plate:	0.063	pf
Grid No.1 to Cathode, Heater, Grid No.2, and Internal Shield:	10.2	pf
Plate to Cathode, Heater, Grid No.2, Grid No.3, and Internal Shield:	3.5	pf

CLASS A₁ AMPLIFIER

Maximum Ratings, (Design-Maximum Values):	
PLATE SUPPLY VOLTAGE:	380 <i>max</i>
GRID-No.3 (SUPPRESSOR-GRID) VOLTAGE, Positive Value:	0 <i>max</i>
GRID-No.2 (SCREEN-GRID) VOLTAGE:	190 <i>max</i>
GRID-No.1 (CONTROL-GRID) VOLTAGE:	-55 <i>max</i>
Negative-bias value:	0 <i>max</i>
Positive-bias value:	1.2 <i>max</i>
PLATE DISSIPATION:	6.5 <i>max</i>
PEAK HEATER-CATHODE VOLTAGE:	200 <i>max</i>
Heater negative with respect to cathode:	200 <i>max</i>
Heater positive with respect to cathode:	200 <i>max</i>

Characteristics:

Plate Supply Voltage:	250	volts
Grid No.2 Supply Voltage:	180	volts
Cathode-Bias Resistor:	100	ohms
Plate Resistance (Approx.):	93000	ohms
Transconductance:	11000	μmhos
Plate Current:	26	ma
Grid-No.2 Current:	5.75	ma
Grid-No.1 Voltage (Approx.) for plate current of 20 μA:	-11.6	voltage

Maximum Circuit Values:

Grid-No.1-Circuit Resistance:
For fixed-bias operation
For cathode-bias operation
The dc component must not exceed 100 volts.

0.25 *max* megohm
1 *max* megohm

AVERAGE PLATE CHARACTERISTICS

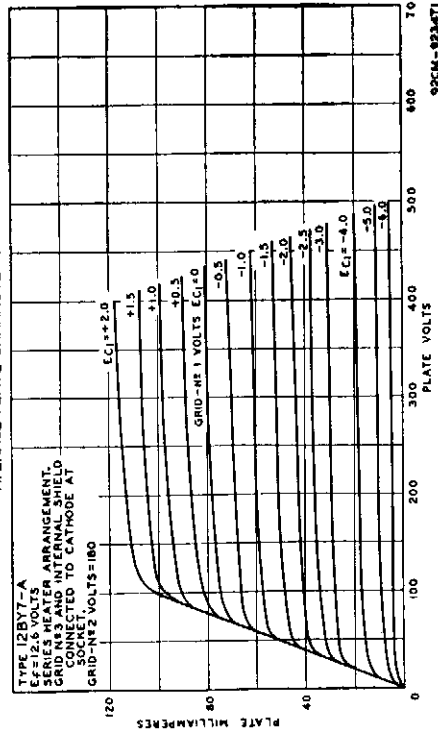

92CM-923471

12BZ6

Related types:
3BZ6, 4BZ6, 6BZ6

SEMIREMOTE-CUTOFF PENTODE

Miniature type used in gain-controlled video if stages of television receivers. Outline 7B, OUTLINES SECTION. Tube requires miniature seven-contact socket and may be mounted in any position. Heater volts (ac/dc), 12.6; amperes, 0.15. Except for heater ratings, this type is identical with miniature type 6BZ6.



HIGH-MU TWIN TRIODE

Miniature type used in sync-separator and sync-amplifier circuits of television receivers. This tube is also used in clipping circuits and in general-purpose audio amplifier applications.



12BZ7

Outline 8D, OUTLINES SECTION. Tube requires miniature nine-contact socket and may be mounted in any position. Heater volts (ac/dc), 12.6 (series), 6.3 (parallel); amperes, 0.3 (series), 0.6 (parallel).

CLASS A₁ AMPLIFIER (Each U_{mt})

Maximum Ratings, (Design-Center Values):		
PLATE VOLTAGE:	300 <i>max</i>	volts
GRID VOLTAGE:	-50 <i>max</i>	volts
Negative-bias value:	0 <i>max</i>	volts
Positive-bias value:	1.5 <i>max</i>	watts
PLATE DISSIPATION:	180 <i>max</i>	volts
PEAK HEATER-CATHODE VOLTAGE:	180 <i>max</i>	volts
Heater negative with respect to cathode:	180 <i>max</i>	volts
Heater positive with respect to cathode:	180 <i>max</i>	volts

Characteristics:		
Plate Voltage:	250	volts
Grid Voltage:	-2	volts
Amplification Factor:	100	ohms
Plate Resistance (Approx.):	31800	μmhos
Transconductance:	3200	ma
Plate Current:	2.5	ma

Maximum Circuit Value:
Grid-Circuit Resistance:
For contact-potential-bias operation.....

12C5

Refer to type 12CU5 / 12C5

TWIN DIODE— SEMIREMOTE-CUTOFF PENTODE

Metal type used as combined detector, amplifier, and avc tube in ac/dc receivers. Outline 7C, OUTLINES SECTION. Heater volts (ac/dc), 12.6; amperes, 0.15. Except for heater ratings, this type is identical with metal type 6B8. Type 12C8 is used principally for renewal purposes.

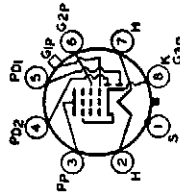

5 max megohms

12CU5 /12C5

Related types:
6CU5, 17CU5

BEAM POWER TUBE

Miniature type used in the audio output stage of television receivers employing series-connected heater strings. Outline 7C, OUTLINES SECTION.

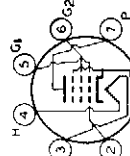

BEAM POWER TUBE

Miniature type used in the audio output stages of television receivers. This type has a controlled heater warm-up time for use in series-connected heater strings. Outline 7C, OUTLINES SECTION. Tube requires miniature seven-contact socket. Heater volts (ac/dc), 12.6; amperes, 0.6; warm-up time (average), 1.1 seconds. Peak heater-cathode volts: heater negative with respect to cathode, 300 *m*az (the dc component must not exceed 200 volts); heater positive with respect to cathode, 200 *m*az (the dc component must not exceed 100 volts). Except for heater and heater-cathode ratings, this type is identical with miniature type 6CA5.

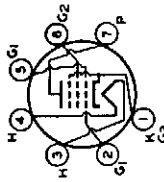

Heater volts (ac/dc), 12.6; amperes, 0.6; warm-up time (average), 1.1 seconds. Except for heater rating, this type is identical with miniature type 6CU5.

12CA5

Related types:
6CA5, 25CA5

REMOTE-CUTOFF PENTODE

Miniature type used as rf amplifier in low B+ voltage automobile radio receivers operating directly from 12-volt storage-battery systems. Outline 7B, OUTLINES SECTION. Tube requires miniature seven-contact socket. Heater-voltage range (ac/dc), 10 to 15.9; amperes at 12.6 volts, 0.15. Characteristics as class A1 amplifier: heater volts, 12.6; plate and grid-No.2 cathode at socket, grid-No.1 volts, 0 *m*az; grid-No.1 resistor (bypassed), 2.2 megohms; plate resistance (approx.), 0.04 megohm; transconductance, 3100 *m*hos; plate ma., 3; grid-No.2 ma., 1.4; peak heater-cathode volts, 30 *m*az. This type is used principally for renewal purposes.

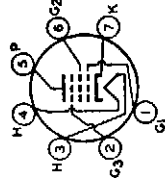

12CX6

DIODE— REMOTE-CUTOFF PENTODE

Miniature type used as combined detector and audio amplifier in automobile and ac-operated radio receivers. The diode unit is used as an AM detector, and the pentode unit as an automatic-volume-controlled audio amplifier. Outline 7B, OUTLINES SECTION. Heater volts (ac/dc), 12.6; amperes, 0.15. Except for heater ratings, this type is identical with miniature type 6CR6.

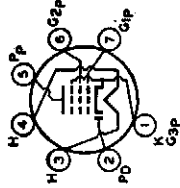

12CR6

Heater volts (ac/dc), 12.6; amperes, 0.15. Except for heater ratings, this type is identical with miniature type 6CR6.

MEDIUM-MU TRIODE— SHARP-CUTOFF PENTODE

Miniature type used in television receivers employing series-connected heater strings. Pentode unit is used as video amplifier; triode unit is used in sweep-oscillator sync-amplifier, separator, and sync-clipper circuits. Outline 8D, OUTLINES SECTION. Tube requires miniature nine-contact socket. Heater volts (ac/dc), 12.6; amperes, 0.3; warm-up time (average), 1.1 seconds. Characteristics of triode unit as class

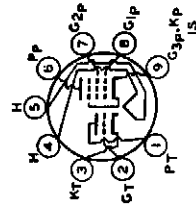

12CT8

A1 amplifier; plate supply volts, 150 (300 *m*az); cathode-bias resistor, 150 ohms; amplification factor, 40; plate resistance (approx.), 8200 ohms; transconductance, 4900 *m*hos; plate ma., 9; plate dissipation, 2.5 *m*az watts. Pentode unit: plate supply volts, 200 (300 *m*az); grid-No.2 supply volts, 125 (300 *m*az); cathode-bias resistor, 82 ohms; plate resistance (approx.), 0.15 megohm; transconductance, 7000 *m*hos; plate ma., 15; grid-No.2 ma., 3.4; plate dissipation, 2.75 *m*az watts; grid-No.2 input, 0.9 *m*az watt. Peak heater-cathode volts, 200 *m*az (the dc component must not exceed 100 volts when heater is positive with respect to cathode). This type is used principally for renewal purposes.

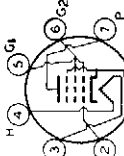

Heater volts (ac/dc), 12.6; amperes, 0.6; warm-up time (average), 1.1 seconds. Except for heater rating, this type is identical with miniature type 6CU5.

Heater volts (ac/dc), 12.6; amperes, 0.6; warm-up time (average), 1.1 seconds. Except for heater rating, this type is identical with miniature type 6CU5.

12CU6

Refer to type 12BQ6-6BT/12CU6

HALF-WAVE VACUUM RECTIFIER

Glass octal type used as damper diode in horizontal-deflection circuits of television receivers employing series-connected heater strings. Outline 14C, OUTLINES SECTION. Tube requires octal socket and may be mounted in any position. Socket terminals 1, 2, 4, and 6 should not be used as tie points. This type may be supplied with pin 1 omitted. It is especially important that this tube, like other power-handling tubes, be adequately ventilated. Heater volts (ac/dc), 12.6; amperes, 0.6; warm-up time (average), 1.1 seconds.

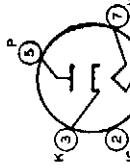

12D4

DAMPER SERVICE

For operation in a 525-line, 30-frame system

Maximum Ratings, (Design-Maximum Values):

PEAK INVERSE PLATE VOLTAGE#	4400 <i>m</i> az	volts
PEAK PLATE CURRENT	900 <i>m</i> az	ma
DC PLATE CURRENT	165 <i>m</i> az	ma
PLATE DISSIPATION	5.5 <i>m</i> az	watts
PEAK HEATER-CATHODE VOLTAGE:		
Heater negative with respect to cathode	4400 <i>m</i> az	volts
Heater positive with respect to cathode	3000 <i>m</i> az	volts
* The duration of the voltage pulse must not exceed 15 per cent of one horizontal scanning cycle. In a 525-line, 30-frame system, 15 per cent of one horizontal scanning cycle is 10 microseconds.		
† The dc component must not exceed 900 volts.		
‡ The dc component must not exceed 100 volts.		

12DB5

BEAM POWER TUBE

Miniature type used as vertical-deflection-amplifier tube in television receivers employing series-connected heater strings. Outline 8D, OUTLINES SECTION, except all vertical dimensions of this type are 1/8 inch greater. Tube requires miniature nine-contact socket and may be operated in any position. Heater volts (ac/dc), 12.6; amperes, 0.6; warm-up time (average), 11 seconds.

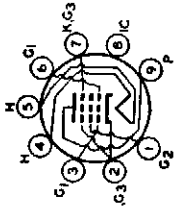

CLASS A₁ AMPLIFIER

Maximum Ratings, (Design-Center Values):

PLATE VOLTAGE.....	300 maz	volts
GRID-NO.2 (SCREEN-GRID) VOLTAGE.....	150 maz	volts
GRID-NO.2 INPUT.....	1.25 maz	watts
PLATE DISSIPATION.....	10 maz	watts
PEAK HEATER-CATHODE VOLTAGE.....	200 maz	volts
Heater positive with respect to cathode.....	200* maz	volts
Heater positive with respect to cathode.....	200* maz	volts

Typical Operation:

Plate Supply Voltage.....	200	volts
Grid-No.2 Supply Voltage.....	125	volts
Cathode-Bias Resistor.....	180	ohms
Peak AF Grid-No.1 Voltage.....	8.5	volts
Zero-Signal Plate Current.....	48	ma
Maximum-Signal Plate Current.....	47	ma
Zero-Signal Grid-No.2 Current.....	2.2	ma
Maximum-Signal Grid-No.2 Current.....	8.5	ma
Plate Resistance (Approx.).....	28000	ohms
Transconductance.....	8000	umhos
Load Resistance.....	4000	ohms
Total Harmonic Distortion.....	1.0	per cent
Maximum-Signal Power Output.....	3.8	watts

Maximum Circuit Values

Grid-No. 1 Circuit Resistance: For fixed-bias operation.....	0.1 maz	megohm
For cathode-bias operation.....	2.2 maz	megohms

VERTICAL-DEFLECTION AMPLIFIER

For operation in a 525-line, 50-frame system

Maximum Ratings, (Design-Center Values):

DC PLATE VOLTAGE.....	300 maz	volts
PEAK POSITIVE-PULSE PLATE VOLTAGE (Absolute Maximum)*.....	2000 maz	volts
DC GRID-NO.2 (SCREEN-GRID) VOLTAGE.....	150 maz	volts
PEAK NEGATIVE-PULSE GRID-NO.1 (CONTROL-GRID) VOLTAGE.....	-250 maz	volts
PEAK CATHODE CURRENT.....	200 maz	ma
AVERAGE CATHODE CURRENT.....	55 maz	ma
GRID-NO.2 INPUT.....	1.25 maz	watts
PLATE DISSIPATION.....	10 maz	watts
PEAK HEATER-CATHODE VOLTAGE.....	200 maz	volts
Heater negative with respect to cathode.....	200* maz	volts
Heater positive with respect to cathode.....	200* maz	volts

Maximum Circuit Values

Grid-No.1-Circuit Resistance: For fixed-bias operation.....	0.1 maz	megohm
For cathode-bias operation.....	2.2 maz	megohms

* The dc component must not exceed 100 volts.
* The duration of the voltage pulse must not exceed 15 per cent of one vertical scanning cycle. In a 525-line, 30-frame system, 15 per cent of one vertical scanning cycle is 2.5 milliseconds.
* Under no circumstances should this absolute maximum value be exceeded.

12DE8

DIODE —

REMOTE-CUTOFF PENTODE

Miniature type used in automobile, radio receivers; pentode unit is used as if amplifier. Outline 8B, OUTLINES SECTION. Tube requires miniature nine-contact socket. Heater-voltage range (ac/dc), 10 to 15.9; amperes at 12.6 volts, 0.2. Characteristics of pentode unit as class A₁ amplifier: heater volts, 12.6; plate and grid-No.2 volts, 12.6 (30 maz); grid-No.3 connected to cathode at socket; grid-No.1 volts (developed across 2.2-megohm resistor) 0.8; plate resistance (approx.) 0.3 megohm; transconductance 1500 umhos; plate ma, 1.8; grid-No.2 0.5; cathode ma, 20 maz; peak heater-cathode volts, 30 maz. Maximum diode plate ma, 5; tube voltage drop for plate current of 20 ma., 5 volts. This type is used principally for renewal purposes.

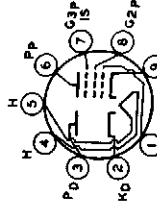

12DK6

Related types:
3DK6, 6DK6

SHARP-CUTOFF PENTODE

Miniature type used as if-amplifier tube in television receivers. Outline 7B, OUTLINES SECTION. Heater volts (ac/dc), 12.6; amperes, 0.15. Except for heater ratings, this type is identical with miniature type 6DK6.

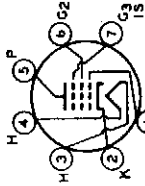

TWIN DIODE — POWER TETRODE

Miniature type used as combined detector, AVC diode, and power amplifier in low B+ voltage automobile radio receivers operating from 12-volt storage-battery systems. Outline 8D, OUTLINES SECTION. Tube requires miniature nine-contact socket. Heater-voltage range (ac/dc), 10 to 15.9; amperes at 12.6 volts, 0.5. Typical operation of tetrode unit as class A₁ amplifier: heater volts, 12.6; plate and grid-No.2 volts, 12.6 (30 maz); grid-No.1 resistor, 15 megohms; peak at grid-No.1 volts (from 0.2-megohm signal source), 1.4; plate ma., 6 (maximum-signal); load resistance, 3500 ohms; maximum-signal power output, 10 milliwatts; plate dissipation, 0.5 maz watt; peak heater-cathode volts, 30 maz. Diode characteristics (each unit): heater volts, 12.6; plate volts, 10; plate ma., 1. This type is used principally for renewal purposes.

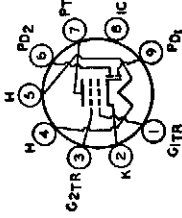

TWIN DIODE — POWER TETRODE

Miniature type used as combined detector and power amplifier driver in low B+ voltage automobile radio receivers operating directly from 12-volt storage-battery systems. Outline 8D, OUTLINES SECTION. Tube requires miniature nine-contact socket. Heater-voltage range (ac/dc), 10 to 15.9; amperes at 12.6 volts, 0.55. Typical operation of tetrode unit as audio driver: heater volts, 12.6; plate volts, 12.6 (30 maz); grid-No.2 volts (obtained from 0.1-megohm source), 2.5; grid-No.1 (space-charge-grid) volts, 12.8 (16 absolute maz); plate ma., 40 (zero-signal), 8 (maximum signal); grid-No.1 ma., 75; load resistance, 800 ohms; maximum-signal power output, 40 milliwatts. Characteristics: plate, heater, and grid-No.1 volts, 12.6; grid-No.2 volts, -0.5; plate resistance (approx.), 480 ohms; transconductance (grid-No.2 to plate), 15000 umhos; amplification factor (grid-No.2 to plate), 7.2. Maximum diode plate ma. (each unit), 5. Peak heater-cathode volts, 30 maz. This type is used principally for renewal purposes.

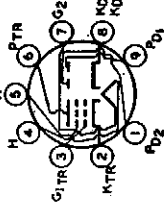

12DM4

Related types:
6DM4, 17DM4

HALF-WAVE VACUUM RECTIFIER

Glass octal type used as damper tube in horizontal-deflection circuits of television receivers employing series-connected heater strings. Outline 14F, OUTLINES SECTION. Heater volts (ac/dc), 12.6; amperes, 0.6; warm-up time (average), 11 seconds. Except for heater rating, this type is identical with glass octal type 6DM4.

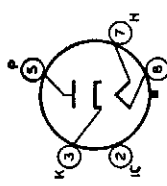

12DQ6A

Related types:
6DQ6A, 6DQ6B,
17DQ6A, 17DQ6B

BEAM POWER TUBE

Glass octal types used as horizontal-deflection-amplifier tubes in television receivers employing series-connected heater strings. Outline 21, OUTLINES SECTION. Heater volts (ac/dc), 12.6; amperes, 0.6; warm-up time (average), 11 seconds. Except for heater ratings, these types are identical with glass octal types 6DQ6-A and 6DQ6-B, respectively.

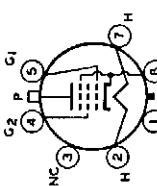

MEDIUM-MU TRIODE— REMOTE-CUTOFF TETRODE

Miniature type used in low B+ voltage automobile radio receivers operating directly from 12-volt storage-battery systems. The tetrode unit is used for relay service in a signal-seeker. Outline 8B, OUTLINES SECTION. Tube requires miniature nine-contact socket.

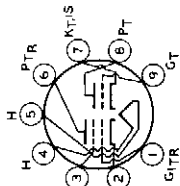

Heater-voltage range (ac/dc), 10 to 15.9; amperes at 12.6 volts, 0.35. Characteristics as class A₁ amplifier: heater volts, 12.6; plate and grid-No.2 (pentode unit), 0; grid-No.1 resistor (pentode unit), 2.2 megohms; amplification factor (triode unit), 20; plate resistance (approx.), 10000 ohms (triode unit); 5000 ohms (tetrode unit); transconductance, 2000 μ mhos (triode unit), 6000 μ mhos (tetrode unit); plate ma., 1.2 (triode unit), 1.4 (tetrode unit); grid-No.2 ma. (tetrode unit), 2; peak heater-cathode volts, 16 max. This type is used principally for renewal purposes.

REMOTE-CUTOFF PENTODE

Miniature type used as rf and if amplifier in low B+ voltage automobile radio receivers operating directly from 12-volt storage-battery systems. Outline 7B, OUTLINES SECTION. Tube requires miniature seven-contact socket and may be mounted in any position.

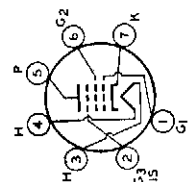

Heater-voltage range (ac/dc).....10 to 15.9 volts
Heater current (approx.) at 12.6 volts.....0.19 ampere
Direct interelectrode capacitances:
Grid No.1 to Plate.....0.05 maz
Grid No.1 to Cathode, Heater, Grid No.2, Grid No.3, and Internal Shield.....9.5 pf
Plate to Cathode, Heater, Grid No.2, Grid No.3, and Internal Shield.....4 pf

12DZ6

Grid-No.2 Voltage.....	12.6	volts
Grid-No.1 Supply Voltage.....	0	volts
Grid-No.1 Resistor (Bypassed).....	10	megohms
Grid-No.3 Resistor (Bypassed).....	10	megohms
Plate Resistance (Approx.).....	25000	ohms
Transconductance.....	3800	μ mhos
Grids No.1 and No.3 Supply Voltage (Approx.) for transconductance, grid No.1 to plate, of 10 μ mhos.....	-10	volts
Plate Current.....	4.5	ma
Grid-No.2 Current.....	2.2	ma

Maximum Circuit Values:

Grid-No.1-Circuit Resistance.....	10 maz	megohms
Grid-No.3-Circuit Resistance.....	10 maz	megohms

*For longest life, it is recommended that the heater be operated within the voltage range of 11 to 14 volts.

REMOTE-CUTOFF PENTODE

Miniature type used as rf amplifier in low B+ voltage automobile radio receivers operating directly from 12-volt storage-battery systems. Outline 7B, OUTLINES SECTION. Tube requires miniature seven-contact socket. Heater-voltage range (ac/dc), 10 to 15.9; amperes at 12.6 volts, 0.19. Characteristics as class A₁ amplifier: heater volts, 12.6; plate and grid-No.2 volts, 12.6 (16 max); grid No.3 connected to cathode at socket; grid-No.1 resistor (bypassed), 10 megohms; plate resistance (approx.), 32000 ohms; transconductance, 3600 μ mhos; plate ma., 3.2; grid-No.2 ma., 1.4; peak heater-cathode volts, 16 max. This type is used principally for renewal purposes.

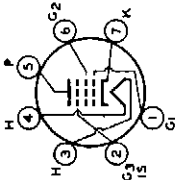

SEMIREMOTE-CUTOFF PENTODE

Miniature type used as combined vhf oscillator and mixer in low B+ voltage automobile radio receivers operating directly from 12-volt storage-battery systems. Outline 8B, OUTLINES SECTION. Tube requires miniature nine-contact socket. Heater-voltage range (ac/dc), 10 to 15.9; amperes at 12.6 volts, 0.225. Characteristics as class A₁ amplifier: heater volts, 12.6; plate and grid-No.2 (pentode unit) volts, 12.6 (16 max); grid-No.1 resistor, 4700 ohms (triode unit), 33000 ohms (pentode unit); amplification factor (triode unit), 25; plate resistance (approx.), 6000 ohms (triode unit), 0.75 megohm (pentode unit); transconductance, 4700 μ mhos (triode unit), 2000 μ mhos (pentode unit); plate ma., 2.4 (triode unit); grid-No.2 ma. (pentode unit), 0.28; peak heater-cathode volts, 16 max. This type is used principally for renewal purposes.

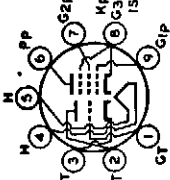

BEAM POWER TUBE

Miniature type used as audio-output amplifier in radio and television receivers employing series-connected heater strings. Outline 13, OUTLINES SECTION. Tube requires miniature seven-contact socket and may be mounted in any position. Heater volts (ac/dc), 12.6; amperes, 0.45; warm-up time (average), 11 seconds.

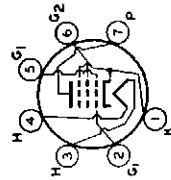

CLASS A₁ AMPLIFIER

Maximum Ratings, (Design-Maximum Values):

Plate Voltage.....	150	volts
Grid-No.2 (Screen-Grid) Voltage.....	150	maz
Grid-No.2 Input.....	1.5	maz
Plate Dissipation.....	6.25	watts

CLASS A₁ AMPLIFIER

Maximum Ratings, (Design-Maximum Values):

Plate Voltage.....	16 maz	volts
Grid-No.2 (Screen-Grid) Voltage.....	16 maz	volts
Grid-No.1 (Control-Grid) Voltage, Positive-bias value.....	0 maz	volts
Peak Heater-Cathode Voltage.....	16 maz	volts
Heater negative with respect to cathode.....	16 maz	volts
Heater positive with respect to cathode.....	16 maz	volts
Characteristics with 12.6 Volts on Heater: Plate Voltage.....	12.6	volts
Grid No.3.....	Connected to cathode at socket	

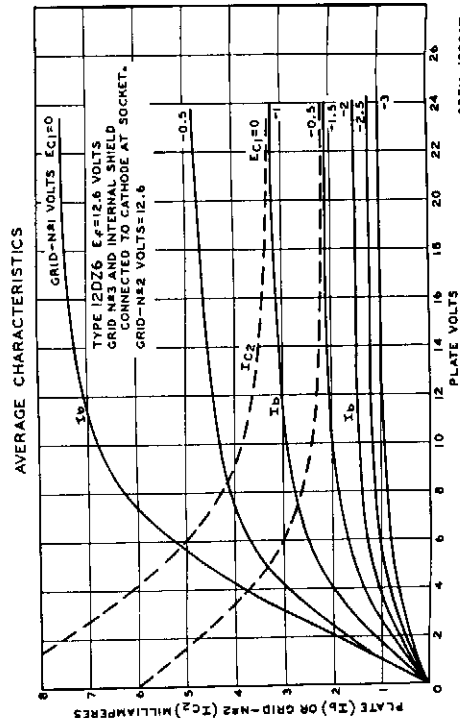

PEAK HEATER-CATHODE VOLTAGE:	
Heater negative with respect to cathode.....	300 ^{max} volts
Heater positive with respect to cathode.....	200 ^{max} volts
Typical Operation:	
Plate Voltage.....	110 volts
Grid-No.2 Voltage.....	110 volts
Grid-No.1 (Control-Grid) Voltage.....	-4 volts
Peak AF Grid-No.1 Voltage.....	4.5 ma
Zero-Signal Plate Current.....	37 ma
Maximum-Signal Plate Current.....	36 ma
Zero-Signal Grid-No.2 Current.....	7 ma
Maximum-Signal Grid-No.2 Current.....	11 ma
Plate Resistance (Approx.).....	14000 ohms
Transconductance.....	8500 μmhos
Load Resistance.....	4500 ohms
Total Harmonic Distortion.....	5 per cent
Maximum-Signal Power Output.....	1.5 watts
Maximum Circuit Values:	
Grid-No.1-Circuit Resistance:	
For fixed-bias operation.....	0.1 maz megohm
For cathode-bias operation.....	0.5 maz megohm
• The dc component must not exceed 200 volts.	
• The dc component must not exceed 100 volts.	

12EG6

PENTAGRID AMPLIFIER

Miniature type used as rf amplifier in low B+ voltage automobile radio receivers operating directly from 12-volt storage-battery systems. Outline 7B, OUTLINES SECTION. Tube requires miniature seven-contact socket. Heater-voltage range (ac/dc), 10 to 15.9; amperes at 12.6 volts, 0.15. Characteristics as class A₁ amplifier; heater volts, 12.6; plate and grids-No.2 and-No.4 volts, 12.6 (16 maz); grid No.3 connected to grid-No.1 through 0.1-megohm resistor; grid-No.1 volts (developed across 2.2-megohm resistor), -0.6; plate resistance (approx.), 0.15 megohm; transconductance (grid No.3 to plate), 800 μmhos; plate ma., 0.55; grids-No.2 and-No.4 ma., 2.8; cathode ma., 20 maz; peak heater-cathode volts, 16 maz. This type is used principally for renewal purposes.

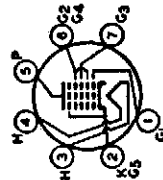

POWER PENTODE

Miniature type used in the audio output stage of radio and television receivers employing series-connected heater strings. Outline 7C, OUTLINES SECTION. Heater volts (ac/dc), 12.6; amperes, 0.6; warm-up time (average), 11 seconds. Peak heater-cathode voltage when the heater is negative with respect to the cathode, 300 maz volts. Except for heater and heater-cathode ratings, this type is identical with miniature type 6EH5.

12EH5

Related types:
6EH5, 25EH5, 50EH5

12EK6

REMOTE-CUTOFF PENTODE

Miniature type used as if and rf amplifier in low B+ voltage automobile radio receivers operating directly from 12-volt storage-battery systems. Outline 7B, OUTLINES SECTION. Tube requires miniature seven-contact socket. Heater-voltage range (ac/dc), 10 to 15.9; amperes at 12.6 volts, 0.19. Characteristics as class A₁ amplifier; heater volts, 12.6; plate and grid-No.2 volts, 12.6 (16 maz); grid No.3 connected to cathode at socket; grid-No.1 supply volts, 0 maz; grid-No.1 resistor (bypassed), 2.2 megohms; plate resistance (approx.), 0.05 megohm; transconductance, 4200 μmhos; plate ma., 4; grid-No.2 ma., 1.7; peak heater-cathode volts, 16 maz. This type is used principally for renewal purposes.

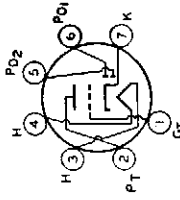
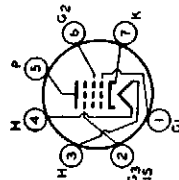

TWIN-DIODE—HIGH-MU TRIODE

Miniature type used as combined detector and audio-amplifier tube in low B+ voltage automobile-radio receivers operating directly from 12-volt storage-battery systems. Outline 7B, OUTLINES SECTION. Tube requires miniature seven-contact socket. Heater-voltage range (ac/dc), 10 to 15.9; amperes at 12.6 volts, 0.15. Characteristics of triode unit as class A₁ amplifier; heater volts, 12.6; plate volts, 12.6 (30 maz); grid volts, 0; amplification factor, 55; plate resistance (approx.), 45000 ohms; transconductance, 1200 μmhos; plate ma., 0.75; cathode ma., 20 maz; peak heater-cathode volts, 30 maz. Maximum diode plate ma. (each unit), 1. This type is used principally for renewal purposes.

12EL6

DIODE—POWER TETRODE

Miniature type used as combined detector and driver for transistorized power output stage in low B+ voltage automobile-radio receivers operating directly from 12-volt storage-battery systems. Outline 8D, OUTLINES SECTION. Heater voltage range (ac/dc), 10.0 to 15.9; amperes (approx.) at 12.6 volts, 0.5. Characteristics for tetrode unit: plate resistance (approx.), 4000 ohms; transconductance, 5000 μmhos; plate and grid-No.2 volts, 12.6; grid-No.1 resistor (bypassed), 2.2 megohms; plate ma., 6; grid-No.2 ma., 1. Maximum ratings, tetrode unit: plate and grid-No.2 volts, 30 maz; plate dissipation, 0.5 maz watts; peak heater-cathode volts, 30 maz. Maximum ratings, tetrode unit: plate ma., 10 maz. Tube requires miniature nine-contact socket and may be operated in any position. Type 12EM6 is a DISCONTINUED type listed for reference only.

12EM6

BEAM POWER TUBE

Glass octal type used as vertical-deflection amplifier tube in television receivers employing series-connected heater strings. Outline 14C, OUTLINES SECTION. Tube requires octal socket. This tube may be supplied with pin No.1 omitted. Heater volts (ac/dc), 12.6; amperes, 0.6; warm-up time (average), 11 seconds. Characteristics as class A₁ amplifier: plate volts, 200; grid-No.2 volts, 116; grid-No.1 volts, -9.5; plate resistance (approx.), 28000 ohms; transconductance, 8000 μmhos. Maximum ratings as vertical-deflection amplifier (for operation in a 52B-line, 30-frame system): dc plate volts, 300 maz; peak positive-pulse plate volts, 1200 maz; dc grid-No.2 volts, 150 maz; peak negative-pulse grid-No.1 volts, -250 maz; cathode ma., 175 (peak), 50 (average); plate dissipation, 7 maz watts; grid-No.2 input, 1.25 maz watts; peak heater-cathode volts: heater negative with respect to cathode, 300 maz (the dc component must not exceed 200 volts), heater positive with respect to cathode, 200 maz (the dc component must not exceed 100 volts). This type is used principally for renewal purposes.

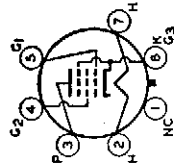

12EN6

DIODE—

REMOTE-CUTOFF PENTODE

Miniature type used as combined amplifier and AM detector in AM and AM/FM radio receivers. Outline 8D, OUTLINES SECTION. Tube requires miniature nine-contact socket and may be operated in any position. Heater volts (ac/dc), 12.6; amperes, 0.15. Except for heater ratings, this type is identical with miniature type 6EQ7.

12EQ7

Related types:
6EQ7, 20EQ7

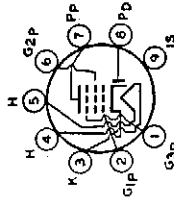

HIGH-MU TRIODE

Glass octal type used in resistance-coupled amplifier circuits of ac/dc receivers. Outline 15A, OUTLINES SECTION. This type may be supplied with pin No. 1 omitted. Heater volts (ac/dc), 12.6; amperes, 0.15. Except for heater ratings, this type is identical with glass-octal type 6F5-GT. Type 12F5-GT is a DISCONTINUED type listed for reference only.

12F5GT
Related type:
6F5GT

TRIODE UNIT AS CLASS A₁ AMPLIFIER

Maximum Ratings, (Design-Center Values):

PLATE VOLTAGE.....	16 max	volts
GRID VOLTAGE.....	0 max	volts
Positive-bias value.....	-16 max	volts
NEGATIVE-BIAS VALUE.....	16 max	volts
Heater negative with respect to cathode.....	16 max	volts
Heater positive with respect to cathode.....	16 max	volts

Characteristics with 12.6 Volts on Heater:

Plate Voltage.....	12.6	volts
Grid-Supply Voltage.....	0	volts
Grid Resistor (Bypassed).....	2.2	megohms
Plate Resistance (Approx.).....	6200	ohms
Transconductance.....	1200	μmhos
Amplification Factor.....	7.4	ma
Plate Current.....	1.3	volts
Grid Voltage (Approx.) for plate current of 10 μa.....	-4	

Maximum Circuit Value:

Grid-Circuit Resistance.....	10 max	megohms
------------------------------	--------	---------

DIODE UNITS

Maximum Ratings, (Design-Center Values):

PLATE CURRENT (Each unit).....	1 max	ma
--------------------------------	-------	----

TWIN DIODE—MEDIUM-MU TRIODE

Miniature type used as combined detector and af voltage amplifier in low B+ voltage automobile radio receivers operating directly from 12-volt storage-battery systems. Outline 7B, OUTLINES SECTION. Tube requires miniature seven-contact socket. Heater-voltage range (ac/dc), 10 to 15.9; amperes at 12.6 volts, 0.15. Characteristics of triode unit as class A₁ amplifier: heater volts, 12.6; plate volts, 12.6 (30 max); grid resistor (bypassed), 2.2 megohms; amplification factor, 10; plate resistance (approx.), 7700 ohms; transconductance, 1900 μmhos; plate ma, 1; peak heater-cathode volts, 30 max. Maximum diode plate ma. (each unit), 1. This type is used principally for renewal purposes.

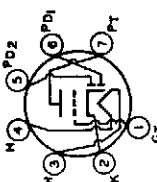

12FK6

LINES SECTION. Tube requires miniature seven-contact socket and may be mounted in any position.

HEATER-VOLTAGE RANGE (AC/DC)..... 10.0 to 15.9 volts
 HEATER CURRENT (Approx.) at 12.6 volts..... 0.15 ampere
 DIRECT INTERELECTRODE CAPACITANCES (Approx.):
 Triode Grid to Triode Plate..... 1.6 pf
 Triode Grid to Cathode and Heater..... 1.8 pf
 Triode Plate to Cathode and Heater..... 0.7 pf
 Plate of Diode Unit No. 1 to Plate of Diode Unit No. 2..... 0.9 pf

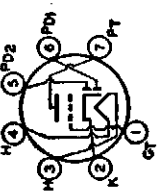

TWIN DIODE—REMOTE-CUTOFF PENTODE

Miniature type used as combined detector and af voltage amplifier in low B+ voltage automobile radio receivers operating directly from 12-volt storage-battery systems. Outline 8B, OUTLINES SECTION. Tube requires miniature nine-contact socket. Heater-voltage range (ac/dc), 10 to 15.9; amperes at 12.6 volts, 0.15. Typical operation of pentode unit as class A₁ amplifier: heater volts, 12.6; plate and grid-No. 3 connected to cathode at socket; grid-No. 1 volts, 0 max; plate resistance (approx.), 0.33 megohm; transconductance, 1000 μmhos; plate ma, 1; grid-No. 2 ma, 0.38; peak heater-cathode volts, 30 max. Maximum diode plate ma. (each unit), 1. This type is used principally for renewal purposes.

12F8

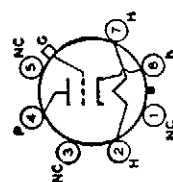
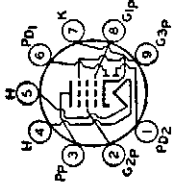

HIGH-MU TWIN DOUBLE-PLATE TRIODE

Miniature type used in frequency-divider and complex-wave-generator circuits of electronic musical instruments. Outline 8B, OUTLINES SECTION. Tube requires miniature nine-contact socket and may be mounted in any position. Heater volts (ac/dc), 12.6; amperes, 0.15.

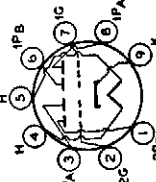

CLASS A₁ AMPLIFIER

Characteristics, (Each Unit):

Plate Voltage.....	250	volts
Grid Voltage.....	1.5	volts
Amplification Factor.....	95	
Plate Resistance (Approx.).....	76000	ohms
Transconductance.....	1250	μmhos
Plate Current.....	1.5	ma

■ Using either plate A or plate B, with plate not in use connected to ground.

FREQUENCY-DIVIDER AND COMPLEX-WAVE GENERATOR

Each Unit

Maximum Ratings, (Design-Maximum Values):

PLATE A VOLTAGE.....	350 max	volts
PLATE B VOLTAGE.....	350 max	volts
GRID VOLTAGE, Positive-bias value.....	0 max	volts
PLATE A DISSIPATION.....	0.5 max	watt
PLATE B DISSIPATION.....	0.5 max	watt

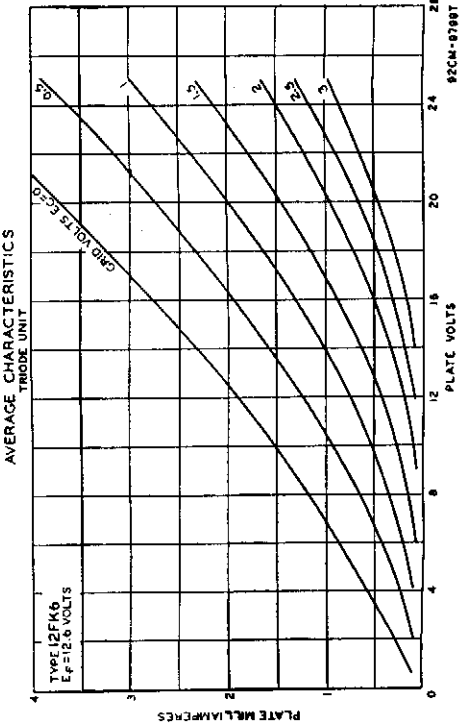

PEAK HEATER-CATHODE VOLTAGE:

- Heater negative with respect to cathode..... volts
- Heater positive with respect to cathode..... volts
- The dc component must not exceed 100 volts.

**DIODE —
MEDIUM-MU TRIODE —
REMOTE-CUTOFF PENTODE**

12FR8

Miniature type used as combined if amplifier, af amplifier, and second detector in low B+ voltage automobile radio receivers operating directly from 12-volt storage-battery systems. Outline 8D, OUTLINES SECTION, except vertical dimensions are 3/16 inch shorter. Tube requires miniature nine-contact socket and may be operated in any position. Heater-voltage range (dc), 10 to 15.9; amperes at 12.6 volts, 0.32.

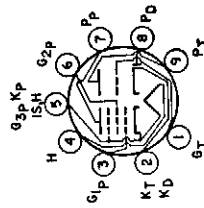

CLASS A₁ AMPLIFIER

Maximum Ratings, (Design-Center Values):

PLATE VOLTAGE.....	12.6	volts
GRID-No.2 Voltage.....	12.6	volts
GRID-No.1 Voltage.....	-0.6	volt
Amplification Factor.....	10	
Plate Resistance (Approx.).....	1200	megohms
Transconductance.....	1	μmhos
Plate Current.....	1	ma
Grid-No.2 Current.....	0.7	ma
Grid-No.1 Voltage (Approx.) for transconductance of 30 μmhos.....	-2.8	volts
Grid Voltage (Approx.) for plate current of 10 μa.....	-3.5	volts
Developed across a 2.2-megohm grid-No.1 resistor.		
Maximum Circuit Values:		
Grid-No.1-Circuit Resistance.....	10 maz	megohms

Characteristics with 12.6 Volts on Heater:

Plate Voltage.....	12.6	volts
Grid-No.2 Voltage.....	12.6	volts
Grid-No.1 Voltage.....	-0.8	volt
Amplification Factor.....	10	
Plate Resistance (Approx.).....	1200	megohms
Transconductance.....	1	μmhos
Plate Current.....	1	ma
Grid-No.2 Current.....	0.7	ma
Grid-No.1 Voltage (Approx.) for transconductance of 30 μmhos.....	-2.8	volts
Grid Voltage (Approx.) for plate current of 10 μa.....	-3.5	volts
Developed across a 2.2-megohm grid-No.1 resistor.		
Maximum Circuit Values:		
Grid-No.1-Circuit Resistance.....	10 maz	megohms

DIODE UNIT

Maximum Ratings, (Design-Center Values):

PLATE CURRENT.....	5 maz	ma
Characteristics, Instantaneous Value:		
Tube Voltage Drop for plate current of 2 ma.....	10	volts

MEDIUM-MU TWIN TRIODE

Miniature type used in relay-control tuning units of television receivers. Outline 8D, OUTLINES SECTION. Tube requires miniature nine-contact socket and may be mounted in any position.

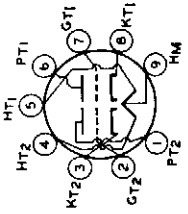

HEATER ARRANGEMENT:

HEATER VOLTAGE (ac/dc).....	Series	12.6	volts
HEATER CURRENT.....	Parallel	6.3	ampere
DIRECT INTERELECTRODE CAPACITANCES (Each Unit, Approx.):		0.45	
Grid to Plate.....		6	pf
Grid to Cathode and Heater.....		0.6	pf
Plate to Cathode and Heater.....		5.5	pf

12FV7

CLASS A₁ AMPLIFIER (Each Unit)

Characteristics:		
Plate Voltage.....	100	volts
Grid Voltage.....	-2	volts
Amplification Factor.....	21.5	
Plate Resistance (Approx.).....	2250	ohms
Transconductance.....	9600	μmhos
Plate Current.....	16	ma
Grid Voltage (Approx.) for plate current of 100 μa.....	-10	volts

RELAY CONTROL (Each Unit)

Maximum Ratings, (Design-Maximum Values):

PLATE VOLTAGE.....	300 maz	volts
GRID VOLTAGE, Positive-bias value.....	0 maz	volts
CATHODE CURRENT.....	30 maz	ma
PLATE DISSIPATION:		
For ON times up to 30 seconds in any 2-minute interval.....	4.5 maz	watts
For ON times exceeding 30 seconds in any 2-minute interval.....	2.5 maz	watts
PEAK HEATER-CATHODE VOLTAGE:		
Heater negative with respect to cathode.....	200 maz	volts
Heater positive with respect to cathode.....	200-maz	volts

Typical Operation with 5000-Ohm Relay Load (Each Unit):

Plate-Supply Voltage.....	270	volts
Zero-Bias Plate Current.....	36	ma
Grid Resistor.....	2.2	megohms
Grid Voltage (Approx.) for plate current of 2 ma.....	-18	volts

Maximum Circuit Values:

Grid-Circuit Resistance.....	3.3	megohms
The dc component must not exceed 100 volts.		

AVERAGE PLATE CHARACTERISTICS EACH UNIT

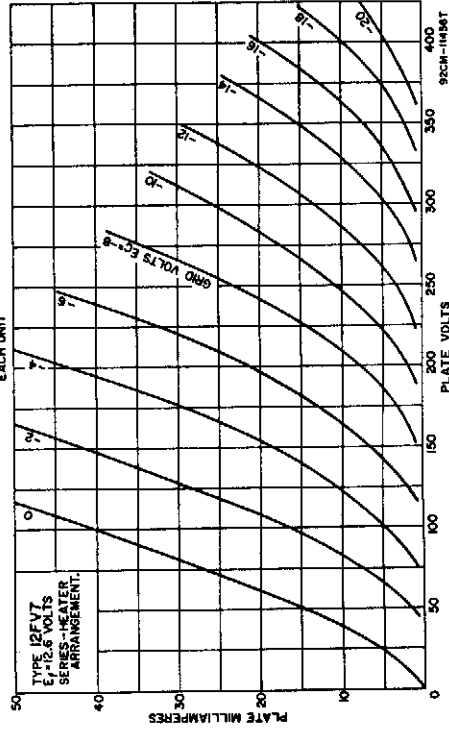

POWER PENTODE

Miniature type used in output stages of audio amplifiers employing series-connected heater strings. Outline 7C, OUTLINES SECTION. Heater volts (ac/dc), 12.6; amperes, 0.45; warm-up time (average), 11 seconds. Except for heater ratings, this type is identical with miniature type 60FX5.

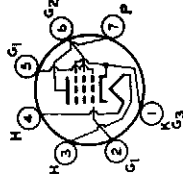

12FX5

Related type: 60FX5

12SA7

12SA7GT

Related types:
6SA7, 6SA7GT

PENTAGRID CONVERTER

Metal type 12SA7 and glass octal type 12SA7-GT used as converter in ac/dc receivers. Outlines 2 and 14C, respectively, OUTLINES SECTION. Heater volts (ac/dc), 12.6; amperes, 0.15. Except for heater ratings, these types are identical with metal type 6SA7 and glass octal type 6SA7-GT. Type 12SA7-GT is used principally for renewal purposes.

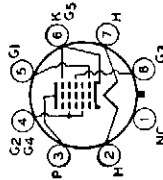
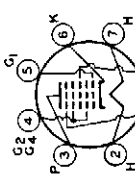

HIGH-MU TWIN TRIODE

Metal type used as phase inverter or voltage amplifier in ac/dc radio equipment. Outline 2, OUTLINES SECTION. Heater volts (ac/dc), 12.6; amperes, 0.15. Except for heater ratings, this type is identical with metal type 6SC7. Type 12SC7 is used principally for renewal purposes.

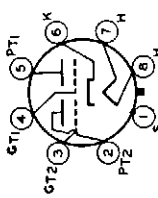

HIGH-MU TRIODE

Metal type 12SF5 and glass octal type 12SF5-GT used in resistance-coupled amplifier circuits of ac/dc radio equipment. Outline 2 and 14C, respectively, OUTLINES SECTION. Heater volts (ac/dc), 12.6; amperes, 0.15. Except for heater ratings, these types are identical with metal type 6SF5 and glass octal type 6SF5-GT, respectively. Type 12SF5-GT is a DISCONTINUED type listed for reference only. Type 12SF5 is used principally for renewal purposes.

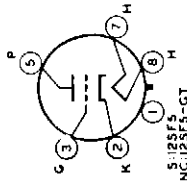

DIODE — REMOTE-CUTOFF PENTODE

Metal type used as combined rf or if amplifier and detector or avc tube in ac/dc radio receivers. Outline 2, OUTLINES SECTION. Heater volts (ac/dc), 12.6; amperes, 0.15. Except for heater ratings, this type is identical with metal type 6SF7. Type 12SF7 is used principally for renewal purposes.

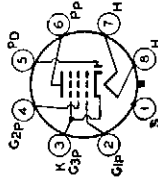

SEMIREMOTE-CUTOFF PENTODE

Metal type used as rf amplifier in ac/dc receivers involving high-frequency, wide-band applications. Outline 2, OUTLINES SECTION. Heater volts (ac/dc), 12.6; amperes, 0.15. Except for heater ratings, this type is identical with metal type 6SG7. Type 12SG7 is used principally for renewal purposes.

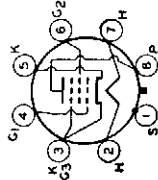

12SG7

Related type:
6SG7

SHARP-CUTOFF PENTODE

Metal type used as rf amplifier in ac/dc receivers involving high-frequency, wide-band applications and as limiter tube in FM equipment. Outline 3, OUTLINES SECTION. Heater volts (ac/dc), 12.6; amperes, 0.15. Except for heater ratings, this type is identical with metal type 6SH7. Type 12SH7 is used principally for renewal purposes.



SHARP-CUTOFF PENTODE

Metal type 12SJ7 and glass-octal type 12SJ7-GT used as rf amplifiers and biased detectors in ac/dc radio receivers. Outline 2 and 14C, respectively, OUTLINES SECTION.

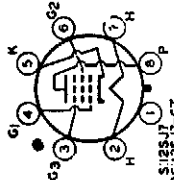

Heater volts (ac/dc), 12.6; amperes, 0.15. Except for heater ratings, these types are identical with metal type 6SJ7 and glass-octal type 6SJ7-GT. Type 12SJ7-GT is a DISCONTINUED type listed for reference only.

REMOTE-CUTOFF PENTODE

Metal type 12SK7 and glass octal type 12SK7-GT used as rf and if amplifiers in ac/dc radio receivers. Outlines 2 and 14C, respectively, OUTLINES SECTION. Heater volts (ac/dc), 12.6; amperes, 0.15. Except for heater ratings, these types are identical with metal type 6SK7 and glass octal type 6SK7-GT. Type 12SK7-GT is used principally for renewal purposes.

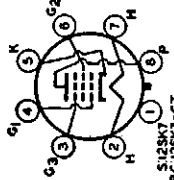

12SK7

12SK7GT

Related types:
6SK7, 7SK7GT

HIGH-MU TWIN TRIODE

Glass octal type used as phase inverter or resistance-coupled amplifier in ac/dc radio equipment. Outline 14C, OUTLINES SECTION. Heater volts (ac/dc), 12.6; amperes, 0.15. Except for heater rating, this type is identical with glass octal type 6SL7-GT.

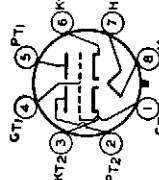

12SL7GT

Related type:
6SL7GT

MEDIUM-MU TWIN TRIODE

Glass octal types used as combined vertical oscillators and horizontal deflection amplifiers, and as horizontal deflection oscillators in television receivers. May also be used in multivibrator

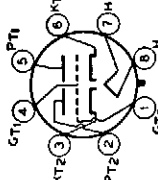

12SN7GT

12SN7GTA

Related type:
6SN7GTa

or resistance-coupled amplifier circuits in radio receivers. Outline 14C, OUTLINES SECTION. Heater volts (ac/dc), 12.6; amperes, 0.3. Except for heater ratings, these types are identical with glass octal types 6SN7-GT and 6SN7-GTB, respectively. Type 12SN7-GT is a DISCONTINUED type listed for reference only.

12SG7

Related type:
6SG7

12SQ7 12SQ7GT

Related types:
6SQ7, 6SQ7GT

Heater volts (ac/dc), 12.6; amperes, 0.15. Except for heater ratings, these types are identical with metal type 6SQ7 and glass octal type 6SQ7-GT.

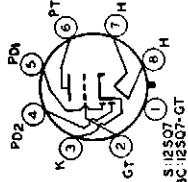

TWIN DIODE—HIGH-MU TRIODE

Metal type 12SQ7 and glass octal type 12SQ7-GT used as combined detector, amplifier, and AVC tube in ac/dc radio receivers. Outlines 2 and 14C, respectively, OUTLINES SECTION.

12SR7 12SR7GT

Related types:
6SR7, 6SR7GT

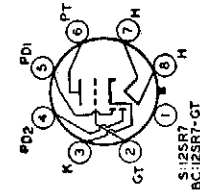

TWIN DIODE—MEDIUM-MU TRIODE

Metal type 12SR7 and glass octal type 12SR7-GT used as combined detector, amplifier, and AVC tube in ac/dc radio receivers. Outlines 2 and 14C, respectively, OUTLINES SECTION. Heater volts (ac/dc), 12.6; amperes, 0.15. Except for heater rating, type 12SR7-GT is electrically identical with type 6SR7 except for interelectrode capacitances. Type 12SR7 is used principally for renewal purposes. The 12SR7-GT is a DISCONTINUED type listed for reference only.

12U7

MEDIUM-MU TWIN TRIODE

Miniature type used as general-purpose amplifier tube in automobile-radio receivers operating directly from 12-volt storage-battery systems. Outline 8B, OUTLINES SECTION. Tube requires miniature nine-contact socket and may be mounted in any position. Heater voltage range (ac/dc), 10.0 to 15.9; amperes (approx.) at 12.6 volts, 0.15. Maximum ratings (each unit) as class A₁ amplifier: plate volts, 30 max; cathode ma., 15 max; heater-cathode volts, 30 max. This type is used principally for renewal purposes.

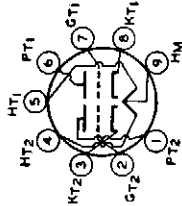

12V6GT

Related types:
5V6GT, 6V6GT

Except for heater rating, this type is identical with glass octal type 6V6-GT.

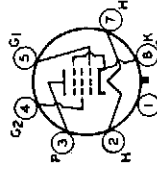

BEAM POWER TUBE

Glass octal type used as output amplifier primarily in automobile radio receivers operating from a 12-volt storage battery. Outline 14C, OUTLINES SECTION. Tube requires octal socket



BEAM POWER TUBE

Glass octal type used in the audio output stages of television receivers employing series-connected heater strings. Triode-connected, this type is used as a vertical deflection amplifier. Outline 14C, OUTLINES SECTION. This type may be supplied with pin No.1 omitted. Heater volts (ac/dc), 12.6; amperes, 0.6; warm-up time (average), 11 seconds. Peak heater-cathode volts: heater negative with respect to cathode, 300 max (the dc component must not exceed 200 volts); heater positive with respect to cathode, 200 max (the dc component must not exceed 100 volts). Except for heater and heater-cathode ratings, this type is identical with glass octal type 6W6-GT.

FULL-WAVE VACUUM RECTIFIER

Miniature type used in power supply of automobile radio receivers operating from a 12-volt storage battery. Outline 7C, OUTLINES SECTION. Heater volts (ac/dc), 12.6; amperes, 0.3. Except for heater ratings, this type is identical with miniature type 6X4.

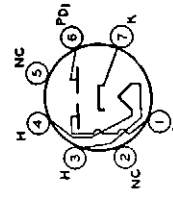

12X4

Related type:
6X4

12Z3

HALF-WAVE VACUUM RECTIFIER

Glass types used in power supply of ac/dc receivers. Maximum dimensions: over-all length, 4-3/16 inches; seated height, 3-9/16 inches; diameter, 1-9/16 inches. Tube requires four-contact socket. Heater volts (ac/dc), 12.6; amperes, 0.3. Maximum ratings as half-wave rectifier: peak inverse plate volts, 700 max; peak plate ma., 380 max; dc output ma., 55 max; peak heater-cathode volts, 350 max. This is a DISCONTINUED type listed for reference only.

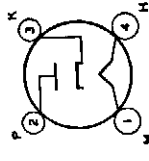

HIGH-MU TRIODE

Nuvistor type used in booster amplifiers of antenna systems serving multiple television receiver installations. Outline 1, OUTLINES SECTION. Heater volts (ac/dc), 13.5; amperes, 0.06. Except for heater ratings, this type is identical with nuvistor type 6CW4.

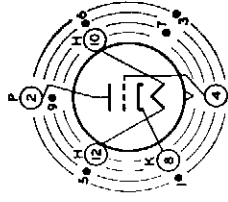

13CW4

Related types:
2CW4, 6CW4

DUAL TRIODE

Miniature type used as combined vertical-deflection-oscillator and vertical-deflection-amplifier tube in television receivers employing series-connected heater strings. Unit No.1 is a medium-mu triode unit used as a blocking oscillator in vertical-deflection circuits, and unit No.2 is a low-mu triode unit used as a vertical-deflection amplifier. Outline 8D, OUTLINES SECTION. Heater volts (ac/dc), 13; amperes, 0.45; warm-up time (average), 11 seconds. Except for heater ratings, this type is identical with miniature type 6DE7.

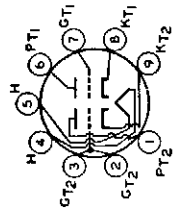

13DE7

Related types:
6DE7, 10DE7

DUAL TRIODE

Miniature type containing high-mu and low-mu triodes; used as combined vertical-deflection-oscillator and vertical-deflection-amplifier tube in television receivers. Outline 8D, OUTLINES SECTION. Tube requires miniature nine-contact socket and may be operated in any position. Heater volts (ac/dc), 13; amperes, 0.45; warm-up time (average), 11 seconds. Except for heater ratings, this type is identical with type 6DR7.

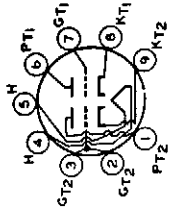

13DR7

Related types:
6DR7, 10DR7

13EM7

Related types:
6EM7, 10EM7

DUAL TRIODE

Glass octal type containing high-mu triode and high-perveance, low-mu triode; used as combined vertical-deflection oscillator and vertical-deflection amplifier in television receivers

employing series-connected heater strings. Outline 14B, OUTLINES SECTION. Heater volts (ac/dc), 13; amperes, 0.45; warm-up time (average), 11 seconds. Except for heater ratings, this type is identical with type 6EM7.

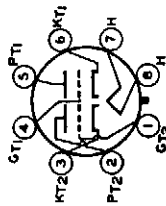

13FD7

Related type:
6FD7

DUAL TRIODE

Glass type containing high-mu and low-mu triode units used as combined vertical-deflection oscillator and vertical-deflection amplifier in television receivers employing series-connected

heater strings. Heater volts (ac/dc), 13; amperes, 0.45; warm-up time (average), 11 seconds. Except for heater ratings, this type is identical with glass type 6FD7.

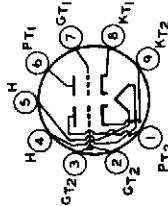

13GB5

BEAM POWER TUBE

Neonval type used as horizontal-deflection amplifier in television receivers. Maximum dimensions: overall length, 4-7/64 inches; seated height, 3-49/64 inches; diameter, 1-3/16 in.

Tube requires neonval nine-contact socket and may be mounted in any position. Heater volts (ac/dc), 13.3; amperes, 0.6. Typical instantaneous characteristics (measured with recurrent waveform such that maximum ratings are not exceeded): plate volts, 75; grid-No.2 volts, 200; grid-No.1 volts, -10; plate ma., 440; grid-No.2 ma., 37.

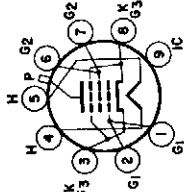

HORIZONTAL DEFLECTION AMPLIFIER

For operation in a 525-line, 30-frame system

Maximum Ratings, (Design-Maximum Values):	
DC PLATE VOLTAGE.....	275 max volts
PEAK POSITIVE-PULSE PLATE VOLTAGE*	7700 max volts
GRID-NO.2 (SCREEN-GRID) VOLTAGE.....	275 max volts
AVERAGE CATHODE CURRENT.....	275 max ma
PLATE DISSIPATION.....	17 max watts
GRID-NO.2 INPUT.....	6 max watts
PEAK HEATER-CATHODE VOLTAGE:	
Heater negative with respect to cathode.....	250*max volts
Heater positive with respect to cathode.....	250*max volts
Maximum Circuit Values:	
Grid-No.1-Circuit Resistance:	
With drive into grid current (horizontal-deflection applications only).....	2.2 max megohms
Without grid current.....	0.5 max megohm

* The duration of the voltage pulse must not exceed 15 per cent of one horizontal scanning cycle. In a 525-line, 30-frame system, 15 per cent of one horizontal scanning cycle is 10 microseconds.
* The dc component must not exceed 125 volts.

13GF7

Related types:
6GF7, 10GF7

DUAL TRIODE

Novar type containing high-mu and high-perveance, low-mu triode units used as combined vertical-deflection amplifier and vertical-deflection oscillator in television receivers em-

ploying series-connected heater strings. Outline 10A, OUTLINES SECTION. Heater volts (ac/dc), 13; amperes, 0.45; warm-up time (average), 11 seconds. Except for heater ratings, this type is identical with novar type 6GF7.

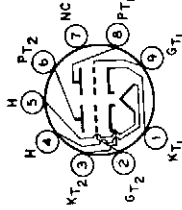

POWER PENTODE— BEAM POWER TUBE

Duodecar type used in FM and television receivers employing series-connected heater strings. The pentode unit is used in audio power-output stages, and the beam power unit is

used as a gated-beam discriminator in FM and television limiter and discriminator applications. Outline 12B, OUTLINES SECTION. Tube requires duodecar twelve-contact socket and may be mounted in any position. Heater volts (ac/dc), 13.2; amperes, 0.45; warm-up time (average), 11 seconds.

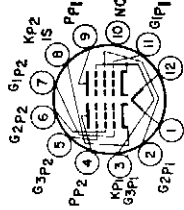

PENTODE UNIT AS CLASS A₁ AMPLIFIER

Maximum Ratings, (Design-Maximum Values):

PLATE VOLTAGE.....	275 max volts
GRID-NO.2 (SCREEN-GRID) VOLTAGE.....	275 max volts
PLATE DISSIPATION.....	10 max watts
GRID-NO.2 INPUT.....	2 max watts
PEAK HEATER-CATHODE VOLTAGE:	
Heater negative with respect to cathode.....	200 max volts
Heater positive with respect to cathode.....	200*max volts

Characteristics and Typical Operation:

Plate Voltage.....	250 volts
Grid-No.2 Voltage.....	250 volts
Grid-No.1 Voltage.....	-8 volts
Peak AF Grid-No.1 Voltage.....	8 volts
Plate Resistance (Approx.).....	0.1 megohm
Transconductance.....	6500 μ mhos
Zero-Signal Plate Current.....	35 ma
Maximum-Signal Plate Current.....	39 ma
Zero-Signal Grid-No.2 Current.....	2.5 ma
Maximum-Signal Grid-No.2 Current.....	7 ma
Load Resistance.....	5000 ohms
Total Harmonic Distortion (Approx.).....	10 per cent
Maximum-Signal Power Output.....	4.2 watts

Maximum Circuit Values:

Grid-No.1-Circuit Resistance:	
For fixed-bias operation.....	0.25 max megohm
For cathode-bias operation.....	0.5 max megohm

BEAM POWER UNIT AS GATED-BEAM DISCRIMINATOR

Maximum Ratings, (Design-Maximum Values):

PLATE SUPPLY VOLTAGE.....	330 max volts
GRID-NO.2 (ACCELERATOR-GRID) VOLTAGE.....	110 max volts
PEAK POSITIVE GRID-NO.1 VOLTAGE.....	60 max volts
AVERAGE CATHODE CURRENT.....	13 max ma
PEAK HEATER-CATHODE VOLTAGE:	
Heater negative with respect to cathode.....	200 max volts
Heater positive with respect to cathode.....	200*max volts

* The dc component must not exceed 100 volts.

14A4

MEDIUM-MU TRIODE

Glass lock-in type used as detector, amplifier, or oscillator in ac/dc radio receivers. Outline 13A, OUTLINES SECTION. Tube requires lock-in socket. Heater volts (ac/dc), 12.6; ampere, 0.15. Except for heater rating and capacitances, this type is electrically identical with lock-in type 7A4 and metal type 6J5. Type 14A4 is a DISCONTINUED type listed for reference only.

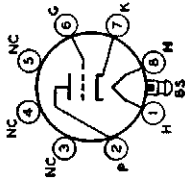

14A5

BEAM POWER TUBE

Glass lock-in type used as output amplifier in ac/dc radio receivers. Outline 13A, OUTLINES SECTION. Tube requires lock-in socket. Heater volts (ac/dc), 12.6; ampere, 0.15. Typical operation and ratings as class A₁ amplifier: plate voltage and grid-No.2 volts, 250 (300 max); plate dissipation, 7.5 watts; grid-No.2 input, 1.5 watts; grid-No.1 volts, -12.5; plate ma., 32; grid-No.1 ma., 5.5; plate resistance, 7000 ohms; transconductance, 3000 μmhos; load resistance, 7500 ohms; output watts, 2.8. This is a DISCONTINUED type listed for reference only.

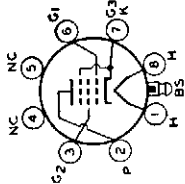

14A7

REMOTE-CUTOFF PENTODE

Glass lock-in type used as rf or if amplifier in ac/dc radio receivers. Outline 13A, OUTLINES SECTION. Tube requires lock-in socket. Heater volts (ac/dc), 12.6; ampere, 0.15. Except for heater rating and capacitances, this type is electrically identical with metal type 6SK7 and lock-in type 7A7. Type 14A7 is used principally for renewal purposes.

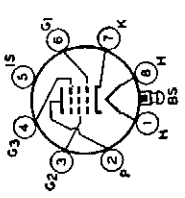

14AF7

MEDIUM-MU TWIN TRIODE

Glass lock-in type used as voltage amplifier or phase inverter in radio equipment. Outline 13A, OUTLINES SECTION. Tube requires lock-in socket. Heater volts (ac/dc), 12.6; ampere, 0.15. Except for heater ratings, this type is electrically identical with lock-in type 7AF7. Type 14AF7 is used principally for renewal purposes.

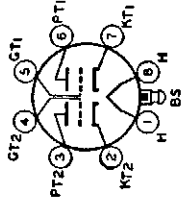

14B6

TWIN DIODE—HIGH-MU TRIODE

Glass lock-in type used as combined detector, amplifier, and avc tube in ac/dc radio receivers. Outline 13A, OUTLINES SECTION. Tube requires lock-in socket. Heater volts (ac/dc), 12.6; ampere, 0.15. Except for heater rating and capacitances, this type is electrically identical with lock-in type 7B6 and metal type 6SQ7. Type 14B6 is used principally for renewal purposes.

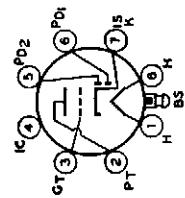

14B8

PENTAGRID CONVERTER

Glass lock-in type used as converter in ac/dc radio receivers. Outline 13A, OUTLINES SECTION. Tube requires lock-in socket. Heater volts (ac/dc), 12.6; ampere, 0.15. Except for heater rating and capacitances, this type is electrically identical with lock-in type 7B8 and metal type 6A8. Type 14B8 is a DISCONTINUED type listed for reference only.

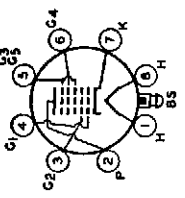

14C5

Glass lock-in type used as output amplifier in ac/dc radio receivers. Outline 13B, OUTLINES SECTION. Tube requires lock-in socket. Heater volts (ac/dc), 12.6; ampere, 0.225. Except for heater ratings, this type is electrically identical with lock-in type 7C5 and metal type 6V6. Type 14C5 is a DISCONTINUED type listed for reference only.

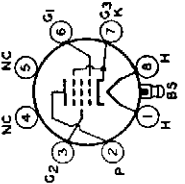

14C7

SHARP-CUTOFF PENTODE

Glass lock-in type used as rf amplifier and biased detector in ac/dc radio receivers. Outline 13A, OUTLINES SECTION. Tube requires lock-in socket. Heater volts (ac/dc), 12.6; ampere, 0.15. Typical operation and maximum ratings as class A₁ amplifier: plate volts, 250 (300 max); grid-No.2 volts, 100; plate dissipation, 1 maw watt; grid-No.2 input, 0.1 maw watt; grid No.1 volts, -3; grid No.3 connected to cathode at socket; plate resistance, greater than 1 megohm; transconductance, 1575 μmhos; plate ma., 2.2; grid-No.2 ma., 0.7. Within the limits of its maximum ratings, this type is similar in performance to metal types 6SJ7 and 12SJ7. Type 14C7 is used principally for renewal purposes.

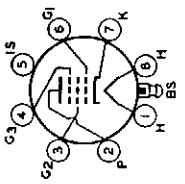

14E6

TWIN DIODE—MEDIUM-MU TRIODE

Glass lock-in type used as combined detector, amplifier, and avc tube in ac/dc radio receivers. Outline 13A, OUTLINES SECTION. Tube requires lock-in socket. Heater volts (ac/dc), 12.6; ampere, 0.15. Except for heater ratings, this type is electrically identical with lock-in type 7E6 and miniature type 6BF6. Type 14E6 is a DISCONTINUED type listed for reference only.

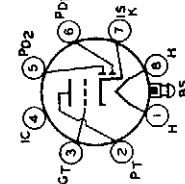

14E7

TWIN DIODE—REMOTE-CUTOFF PENTODE

Glass lock-in type used as combined detector, amplifier, and avc tube in ac/dc receivers. Outline 13A, OUTLINES SECTION. Tube requires lock-in socket. Heater volts (ac/dc), 12.6; ampere, 0.15. Except for heater ratings, this type is electrically identical with lock-in type 7E7. Type 14E7 is a DISCONTINUED type listed for reference only.

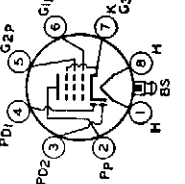

14F7

HIGH-MU TWIN TRIODE

Glass lock-in type used as phase inverter or resistance-coupled amplifier in ac/dc radio receivers. Outline 13A, OUTLINES SECTION. Tube requires lock-in socket. Heater volts (ac/dc), 12.6; ampere, 0.15. Except for heater ratings, this type is electrically identical with lock-in type 7F7 and glass-octal type 6SL7-GT. Type 14F7 is used principally for renewal purposes.

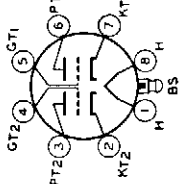

14F8

MEDIUM-MU TWIN TRIODE

Glass lock-in type used as amplifier or oscillator in ac/dc radio equipment. Outline 13A, OUTLINES SECTION, except over-all length is 2.9/32 max inches and seated length is 1.8/4 inches. Tube requires lock-in socket. Heater volts (ac/dc), 12.6; ampere, 0.15. Except for heater ratings, this type is electrically identical with lock-in type 7F8. Type 14F8 is used principally for renewal purposes.

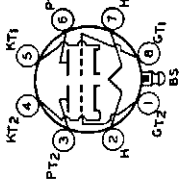

14GT8

TWIN DIODE—HIGH-MU TRIODE

Miniature type used as combined detector and af voltage amplifier in radio receivers. Outline 8B, OUTLINES SECTION. Tube requires lock-in socket. Heater positive with respect to cathode. Heater negative with respect to cathode. Heater positive with respect to cathode.

HEATER VOLTAGE (AC/DC).....	14	volts
HEATER CURRENT.....	0.15	ampere
AMPLIFICATION FACTOR.....	72	
PLATE RESISTANCE (APPROX.) ^o	72000	ohms
TRANSCONDUCTANCE ^o	1000	μmhos

^o For triode unit; plate volts, 250; grid volts, -3; plate ma., 0.7.

TRIODE UNIT AS CLASS A₁ AMPLIFIER

Maximum Ratings, (Design-Maximum Values):	
PLATE VOLTAGE.....	330 micr
GRID VOLTAGE, Positive-bias value.....	0
PLATE DISSIPATION.....	1.1 mazz
PEAK HEATER-CATHODE VOLTAGE:	
Heater negative with respect to cathode.....	200 mazz
Heater positive with respect to cathode.....	200* mazz

DIODE UNITS (Each Unit)

Maximum Ratings, (Design-Maximum Values):	
PLATE CURRENT.....	5
PEAK HEATER-CATHODE VOLTAGE:	
Heater negative with respect to cathode.....	200 mazz
Heater positive with respect to cathode.....	200* mazz

Characteristics, Instantaneous Value:

Tube Voltage Drop for plate current of 18 ma. 5 volts
 ■ The dc component must not exceed 100 volts.

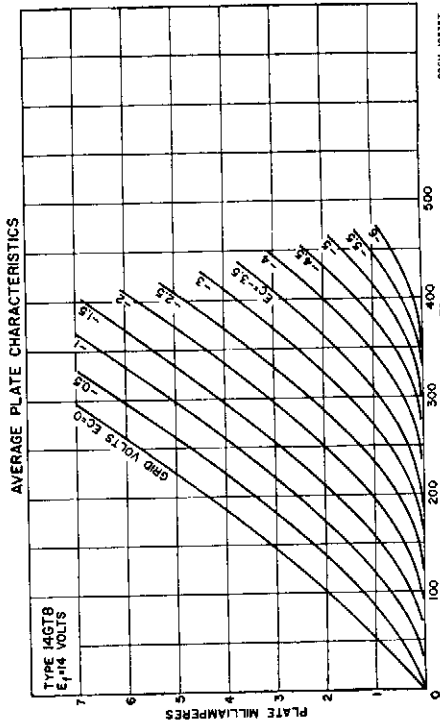

14H7

SEMIREMOTE-CUTOFF PENTODE

Glass lock-in type used as rf or if amplifier in ac/dc radio receivers. Outline 13A, OUTLINES SECTION. Tube requires lock-in socket. Heater volts (ac/dc), 12.6; amperes, 0.15. Except for heater ratings, this type is electrically identical with type 7H7. Type 14H7 is a DISCONTINUED type listed for reference only.

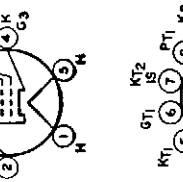
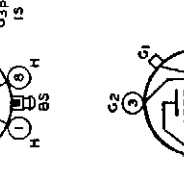
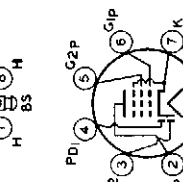
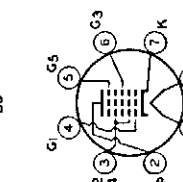
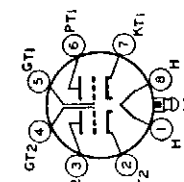
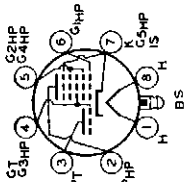
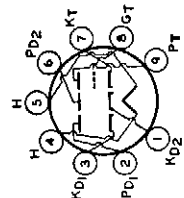

TRIODE—HEPTODE CONVERTER

Glass lock-in type used as combined triode oscillator and heptode mixer in ac/dc radio receivers. Outline 13A, OUTLINES SECTION. Tube requires lock-in socket. Heater volts (ac/dc), 12.6; amperes, 0.15. Except for heater ratings, this type is electrically identical with lock-in type 7J7. Type 14J7 is a DISCONTINUED type listed for reference only.

MEDIUM-MU TWIN TRIODE

Glass lock-in type used as voltage amplifier or phase inverter in ac/dc radio equipment. Outline 13B, OUTLINES SECTION. Tube requires lock-in socket. Heater volts (ac/dc), 12.6; amperes, 0.3. Except for heater ratings and capacitances, this type is electrically identical with lock-in type 7N7 and glass-octal type 6SN7-GT. Type 14N7 is a DISCONTINUED type listed for reference only.

PENTAGRID CONVERTER

Glass lock-in type used as converter in ac/dc radio receivers. Outline 13A, OUTLINES SECTION. Tube requires lock-in socket. Heater volts (ac/dc), 12.6; amperes, 0.15. Except for heater ratings and capacitances, this type is electrically identical with metal type 6SA7 and lock-in type 7Q7. Type 14Q7 is used principally for renewal purposes.

TWIN DIODE—REMOTE-CUTOFF PENTODE

Glass lock-in type used as combined detector, amplifier, and avc tube in ac/dc radio receivers. Outline 13A, OUTLINES SECTION. Tube requires lock-in socket. Heater volts (ac/dc), 12.6; amperes, 0.15. Except for heater ratings, this type is electrically identical with lock-in type 7R7. Type 14R7 is used principally for renewal purposes.

SHARP-CUTOFF PENTODE

Glass type used as rf amplifier in battery-operated receivers. Outline 24B, OUTLINES SECTION. Tube requires five-contact socket. Heater volts (dc), 2.0; amperes, 0.22. Typical operation as class A₁ amplifier: plate volts, 135 mazz; grid-No.2 (screen-grid) volts, 67.5 mazz; grid-No.1 volts, -1.5; plate ma., 1.85; grid-No.2 ma., 0.3; plate resistance, 0.80 megohm; transconductance, 750 μmhos. This is a DISCONTINUED type listed for reference only.

DUAL TRIODE—SHARP-CUTOFF PENTODE

Duodecar type used in a variety of applications in television receivers employing series-connected heater strings. The high-mu triode unit is used in agc-keyer applications, the low-mu triode unit in sync-separator applications, and the pentode unit in video-amplifier applications. Outline 12C, OUTLINES SECTION. Heater volts (ac/dc), 14.7; amperes, 0.45; warm-up time (average), 11 seconds. Except for heater ratings, this type is identical with duodecar type 6AF11.

14J7

14N7

14Q7

14R7

15

15AF11

Related type: 6AF11

15FY7

Related type:
6FY7

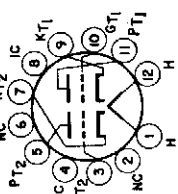

Dual triode type used as combined vertical-deflection oscillator and vertical-deflection amplifier in television receivers employing series-connected heater strings. The high-mu triode unit

No.1 is used as an oscillator, and the low-mu triode unit No.2 is used as an amplifier. Outline 12D, OUTLINES SECTION. Heater volts (ac/dc), 14.7; amperes, 0.45; warm-up time (average), 11 seconds. Except for heater ratings, this type is identical with duodecatriode type 6FY7.

POWER PENTODE



Miniature type used as vertical deflection-amplifier tube in television receivers. Outline 8E, OUTLINES SECTION. Heater volts (ac/dc), 14.7; amperes, 0.3; warm-up time (average), 11 seconds. Except for heater ratings, this type is identical with miniature type 6HB6.

15HB6

Related type:
6HB6

11 seconds. Except for heater ratings, this type is identical with miniature type 6HB6.

HIGH-MU TRIODE — BEAM POWER TUBE

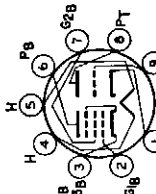

Novar type used in combined vertical-deflection-oscillator and vertical-deflection-amplifier applications in black-and-white television receivers having low-voltage "B" supplies and employing series-connected heater strings. Outline 10C, OUTLINES SECTION. Tube requires novar nine-contact socket and may be mounted in any position.

15KY8

HEATER VOLTAGE (AC/DC)	15 volts
HEATER CURRENT	0.45 ampere
HEATER WARM-UP TIME (Average)	10 seconds
DIRECT INTERELECTRODE CAPACITANCES (Approx.):	
Triode Unit:	
Grid to Plate	0.44 pf
Grid to Cathode and Heater	15 pf
Plate to Cathode and Heater	7 pf
Pentode Unit:	
Grid No.1 to Plate	0.048 pf
Grid No.1 to Cathode, Heater, Grid No.2, and Grid No.3	2.6 pf
Plate to Cathode, Heater, Grid No.2, and Grid No.3	0.28 pf

CLASS A₁ AMPLIFIER

Characteristics:	Triode Unit	Beam Power Unit
Plate Voltage	50	135
Grid-No.2 (Screen-Grid) Voltage	120	120
Grid-No.1 (Control-Grid) Voltage	-3	-10
Amplification Factor	64	7
Plate Resistance (Approx.)	40000	18000
Transconductance	1600	8400
Plate Current	1.4	170*
Grid-No.2 Current	—	20*
Grid-No.1 Voltage (Approx.) for plate current of 1 ma	—	-24

VERTICAL-DEFLECTION OSCILLATOR AND AMPLIFIER

For operation in a 525-line, 30-frame system

	Triode Unit	Beam Power Unit
Oscillator	330 max	300 max
DC PLATE VOLTAGE	—	2200 max
PEAK POSITIVE-PULSE PLATE VOLTAGE† (Absolute Maximum)	—	150 max
DC GRID-NO.2 VOLTAGE	—	—

PEAK NEGATIVE-PULSE GRID-NO.1 VOLTAGE	-400 max	-250 max	volts
PEAK CATHODE CURRENT	77 max	200 max	ma
AVERAGE CATHODE CURRENT	22 max	60 max	ma
PLATE DISSIPATION	1.5 max	12 max	watts
GRID-NO.2 INPUT	—	1.9 max	watts
PEAK HEATER-CATHODE VOLTAGE:			
Heater positive with respect to cathode	200 max	200 max	volts
Heater negative with respect to cathode	200 max	200 max	volts

Maximum Circuit Values:

- Grid-No.1-Circuit Resistance: 2.2 max 2.2 max megohms
- For grid-resistor-bias operation
- * Triode connection, grid No.2 connected to plate at socket.
- † This value can be measured by a method involving a recurrent waveform such that the maximum ratings of the tube will not be exceeded.
- ‡ The duration of the voltage pulse must not exceed 15 per cent of one vertical scanning cycle. In a 525-line, 30-frame system, 15 per cent of one vertical scanning cycle is 2.5 milliseconds.
- † Under no conditions should this maximum value be exceeded.
- ‡ The dc component must not exceed 100 volts.

AVERAGE CHARACTERISTICS

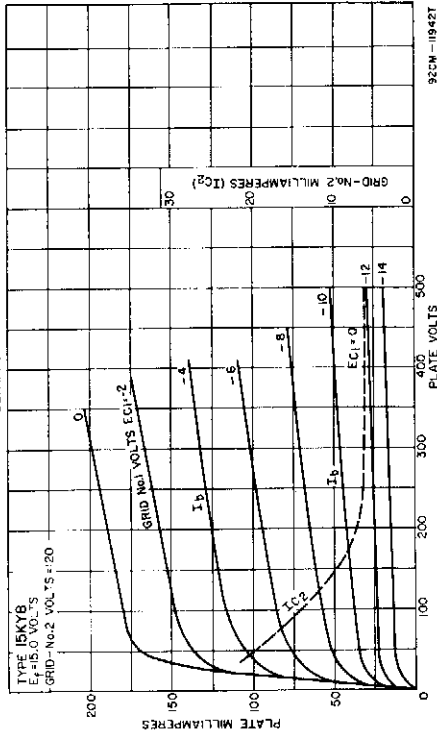

AVERAGE PLATE CHARACTERISTICS

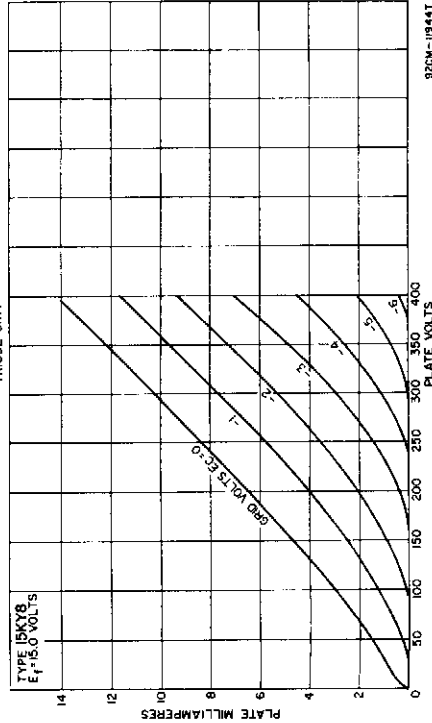

DIODE

Miniature type used as booster diode in line-time-base circuits of transformerless television receivers. Outline 9C, OUTLINES SECTION. Tube requires miniature nine-contact socket in any position. Heater volts (ac/dc), 16.4; amperes, 0.6.

16AQ3

Maximum Ratings, (Design-Center Values):

SUPPLY VOLTAGE at zero current	550 max	volts
PEAK PLATE CURRENT	250 max	volts
PEAK PLATE CURRENT	550 max	ma
AVERAGE PLATE CURRENT	220 max	ma
PLATE DISSIPATION	5 max	watts
PEAK NEGATIVE-PULSE PLATE VOLTAGE*	-6000*max	volts
PEAK HEATER-CATHODE VOLTAGE:	6600*max	volts
Heater negative with respect to cathode	6600*max	volts
Heater positive with respect to cathode		

* Under no conditions should an absolute maximum value of 7500 volts be exceeded.
 • The pulse duration must not exceed 22 per cent of a cycle, or a maximum of 18 microseconds.

HALF-WAVE VACUUM RECTIFIER

Duodecar type used as damper tube in horizontal-deflection circuits of television receivers employing series-connected heater strings. Outline 12C, OUTLINES SECTION. Heater volts (ac/dc), 16.8; amperes, 0.45; warm-up time (average), 11 seconds. Except for heater ratings, this type is identical with duodecar type 6AX3.

17AX3

Related types:
6AX3, 12AX3

**17AX4GT
17AX4GTA**

Related types:
6AX4GT, 6AX4GTA,
12AX4GTA, 12AX4GTB,
25AX4GT

Glass octal types used as damper tubes in horizontal deflection circuits of television receivers employing series-connected heater strings. Outline 14C, OUTLINES SECTION. Heater volts (ac/dc), 16.8; amperes, 0.45; warm-up time (average), 11 seconds. Except for heater ratings, these types are identical with glass octal types 6AX4-GT and 6AX4-GTB, respectively.

17AY3

Related types:
6AY3, 12AY3

Miniature type used as damper tube in horizontal-deflection circuits of black-and-white television receivers employing series-connected heater strings. Outline 17A, OUTLINES SECTION. Heater volts (ac/dc), 16.8; amperes, 0.45; warm-up time (average), 11 seconds. Except for heater ratings, this type is identical with novar type 6AY3.

HALF-WAVE VACUUM RECTIFIER

Novar type used as damper tube in horizontal-deflection circuits of black-and-white television receivers employing series-connected heater strings. Outline 17A, OUTLINES SECTION.

17BH3

Related types:
6BH3, 22BH3

Heater volts (ac/dc), 17.0; amperes, 0.6; warm-up time (average), 11 seconds. Except for heater ratings, this type is identical with novar type 6BH3.

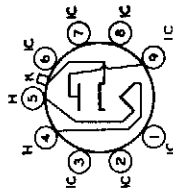

BEAM POWER TUBE

Glass octal type used as horizontal deflection amplifier in television receivers employing series-connected heater strings. Outline 15C, OUTLINES SECTION. Heater volts (ac/dc), 16.8; amperes, 0.45; warm-up time (average), 11 seconds. Except for heater ratings, this type is identical with glass octal type 6BQ6-GTB/6CU6.

17BQ6GTB

Related types:
6BQ6GTB/6CU6, 12BQ6GTB/12CU6, 25BQ6GTB/25CU6

Heater volts (ac/dc), 16.8; amperes, 0.45; warm-up time (average), 11 seconds. Except for heater ratings, this type is identical with glass octal type 6BQ6-GTB/6CU6.

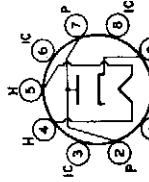

HALF-WAVE VACUUM RECTIFIER

Novar type used as damper tube in horizontal-deflection circuits of black-and-white television receivers employing series-connected heater strings. Outline 10D, OUTLINES SECTION.

17BS3

Related types:
6BS3, 12BS3

Heater volts (ac/dc), 16.8; amperes, 0.45; warm-up time (average), 11 seconds. Except for heater ratings, this type is identical with novar type 6BS3.

SHARP-CUTOFF DUAL TETRODE

Miniature type used as vhf rf-amplifier and autodyne mixer tube. Outline 8B, OUTLINES SECTION. Heater volts (ac/dc), 16.8; amperes, 0.15. Except for heater ratings, this type is identical with miniature type 6C9.

17C9

Related types:
6C9

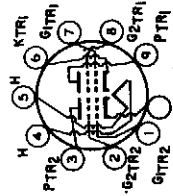

BEAM POWER TUBE

Miniature type used in the audio output stage of television receivers employing series-connected heater strings. Outline 7C, OUTLINES SECTION.

17CU5

Related types:
6CU5, 12CU5/12C5

Heater volts (ac/dc), 16.8; amperes, 0.45; warm-up time (average), 11 seconds. Except for heater ratings, this type is identical with miniature type 6CU5.

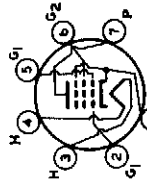

HALF-WAVE VACUUM RECTIFIER

Glass octal type used as damper tube in horizontal-deflection circuits of television receivers employing series-connected heater strings. Outline 14C, OUTLINES SECTION. Heater volts (ac/dc), 16.8; amperes, 0.45; warm-up time (average), 11 seconds. Except for heater ratings, this type is identical with glass octal type 6DA4.

17D4

Related types:
6DA4

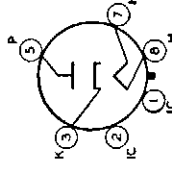

Heater volts (ac/dc), 16.8; amperes, 0.45; warm-up time (average), 11 seconds. Except for heater ratings, this type is identical with glass octal type 6DA4.

17DE4

Related types:
6DE4, 22DE4

(ac/dc), 17; amperes, 0.6; warm-up time (average), 11 seconds. Except for heater ratings, this type is identical with glass octal type 6DE4.

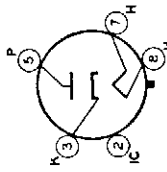

HALF-WAVE VACUUM RECTIFIER

Glass octal type used as damper tube in horizontal-deflection circuits of television receivers employing series-connected heater strings. Outline 14F, OUTLINES SECTION. Heater volts

17DM4

Related types:
6DM4, 12DM4

(ac/dc), 16.8; amperes, 0.6; warm-up time (average), 11 seconds. Except for heater ratings, this type is identical with glass octal type 6DM4.

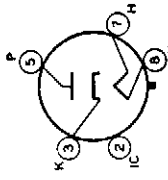

HALF-WAVE VACUUM RECTIFIER

Glass octal type used as damper tube in horizontal-deflection circuits of television receivers employing series-connected heater strings. Outline 14F, OUTLINES SECTION. Heater volts

17DQ6A

17DQ6B

Related types:
6DQ6A, 6DQ6B,
12DQ6A, 12DQ6B

amperes, 0.45; warm-up time (average), 11 seconds. Except for heater ratings, these types are identical with glass octal types 6DQ6-A and 6DQ6-B.

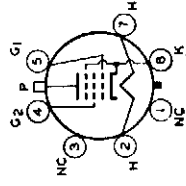

BEAM POWER TUBE

Glass octal types used as horizontal deflection amplifier in television receivers employing series-connected heater strings. Outline 21, OUTLINES SECTION. Heater volts (ac/dc), 16.8;

17GE5

Related types:
6GE5, 12GE5

amperes, 0.45; warm-up time (average), 11 seconds. Except for heater ratings, this type is identical with duodecar type 6GE5.

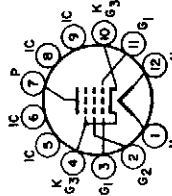

BEAM POWER TUBE

Duodecar type used as horizontal-deflection-amplifier tube in television receivers employing series-connected heater strings. Outline 20, OUTLINES SECTION. Heater volts (ac/dc), 16.8;

BEAM POWER TUBE

Novar type used in horizontal-deflection-amplifier circuits of television receivers employing series-connected heater strings. Outline 18A, OUTLINES SECTION. Tube requires novar nine-

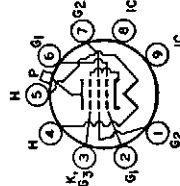

17GJ5

Related types:
6GJ5, 12GJ5

contact socket and may be operated in any position. Heater volts (ac/dc), 16.8; amperes, 0.45; warm-up time (average), 11 seconds. Except for heater ratings, this type is identical with type 6GJ5.

BEAM POWER TUBE

Novar type used in horizontal-deflection-amplifier circuits of television receivers employing series-connected heater strings. Outlines 17A, OUTLINES SECTION. Tube requires no-

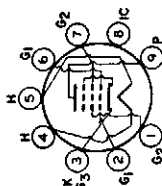

17GT5

Related types:
6GT5, 12GT5

var nine-contact socket and may be operated in any position. Heater volts (ac/dc), 16.8; amperes, 0.45; warm-up time (average), 11 seconds. Except for heater ratings, this tube is identical with novar type 6GT5.

BEAM POWER TUBE

Duodecar type used as horizontal-deflection-amplifier tube in television receivers employing series-connected heater strings. Outline 16C, OUTLINES SECTION. Heater volts (ac/dc), 16.8; amperes, 0.45; warm-up time (average), 11 seconds. Except for heater ratings, this type is identical with duodecar type 6GV5.

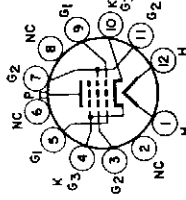

17GV5

Related type:
6GV5

Except for heater ratings, this type is identical with duodecar type 6GV5.

BEAM POWER TUBE

Glass octal type used in horizontal-deflection-amplifier circuits of high-efficiency deflection circuits of television receivers employing series-connected heater strings. Outline 21, OUTLINES SECTION. Tube requires octal socket and may be operated in any position. Heater volts (ac/dc), 16.8; amperes, 0.45; warm-up time (average), 11 seconds. Except for heater ratings, this type is identical with glass octal type 6GW6.

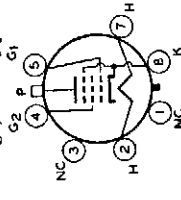

17GW6

Related types:
6GW6, 12GW6

BEAM POWER TUBE

Novar type used as high-efficiency horizontal-deflection-amplifier tube in television receivers employing series-connected heater strings. Outline 18A, OUTLINES SECTION. Heater volts (ac/dc), 16.8; amperes, 0.45; warm-up time (average), 11 seconds. Except for heater ratings, this type is identical with novar type 6JB6.

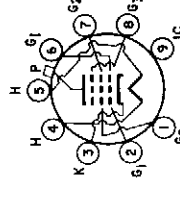

17JB6

Related types:
6JB6, 12JB6

MEDIUM-MU TRIODE — POWER PENTODE

Duodecar type used as combined vertical-deflection-oscillator and vertical-deflection-amplifier tube in television receivers employing series-connected heater strings. Outline 12B, OUTLINES SECTION. Tube requires duodecar twelve-contact socket and may be mounted in any position. Heater volts (ac/dc), 16.8; amperes, 0.45; warm-up time (average), 11 seconds.

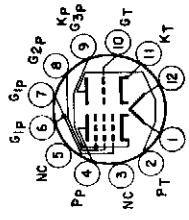

17JZ8

CLASS A₁ AMPLIFIER

Characteristics:	Triode U _{nit}	Pentode U _{nit}
Plate Voltage.....	150	45 120
Grid-No.2 (Screen-Grid) Voltage.....	110	110
Grid-No.1 (Control-Grid) Voltage.....	-5	0 -8
Amplification Factor.....	21.5	-
Plate Resistance (Approx.).....	11300	- 11700
Transconductance.....	1900	- 7100
Plate Current.....	3.3	122* 46
Grid-No.2 Current.....	-	17* 4
Grid-No.1 Voltage (Approx.) for plate current of 100 μ a.....	-	-26
Grid-No.1 Voltage (Approx.) for plate current of 10 μ a.....	-10	-

VERTICAL-DEFLECTION OSCILLATOR AND AMPLIFIER

For operation in a 525-line, 30-frame system.

Triode Unit	Periodic Unit	Amplifier	Volts
Oscillator	250 <i>max</i>	2000 <i>max</i>	volts
DC PLATE VOLTAGE	250 <i>max</i>	200 <i>max</i>	volts
PEAK POSITIVE-PULSE PLATE VOLTAGE*	—	—	volts
GRID-NO.2 VOLTAGE	—	—	volts
PEAK NEGATIVE-PULSE GRID-NO.1 VOLTAGE	—400 <i>max</i>	—150 <i>max</i>	volts
AVERAGE CATHODE CURRENT	70 <i>max</i>	245 <i>max</i>	ma
PEAK CATHODE CURRENT	20 <i>max</i>	70 <i>max</i>	ma
AVERAGE CATHODE CURRENT	1 <i>max</i>	7 <i>max</i>	ma
GRID-NO.2 INPUT	—	1.8 <i>max</i>	watts
PEAK HEATER-CATHODE VOLTAGE:	200 <i>max</i>	200 <i>max</i>	volts
Heater negative with respect to cathode.	200* <i>max</i>	200* <i>max</i>	volts
Heater positive with respect to cathode.	—	—	—

Maximum Circuit Values:

Grid-No.1-Circuit Resistance:	1 <i>max</i>	1 <i>max</i>	megohm
For fixed-bias operation	2.2 <i>max</i>	2.2 <i>max</i>	megohms
For cathode-bias operation	—	—	—

• This value may be measured by a method involving a recurrent waveform such that the maximum ratings of the tube will not be exceeded.

The duration of the voltage pulse must not exceed 15 per cent of one vertical scanning cycle. In a 525-line, 30-frame system, 15 per cent of one vertical scanning cycle is 2.5 milliseconds.

† An adequate bias resistor or other means is required to protect the tube in the absence of excitation.

‡ The dc component must not exceed 100 volts.

HALF-WAVE VACUUM RECTIFIER

Miniature type used as damper tube in horizontal-deflection circuits of television receivers employing series-connected heaters. Outline 8D, OUTLINES SECTION. Tube requires miniature nine-contact socket and may be mounted in any position. Socket terminals 2, 6, 7, and 9 should not be used as tie points. It is especially important that this tube, like other power-handling tubes, be adequately ventilated.

Heater volts (ac/dc), 17.5; amperes, 0.8; warm-up time (average), 11 seconds. Maximum ratings for damper service (for operation in a 525-line, 30-frame system): peak inverse plate volts, 2000 *max*; peak plate *ma.*, 460 *max*; dc plate *ma.*, 75 *max*; plate dissipation, 3 *max* watts; peak heater-cathode volts; heater negative with respect to cathode, 2000 *max* (the dc component must not exceed 500 volts); heater positive with respect to cathode, 200 *max* (the dc component must not exceed 100 volts). This type is used principally for renewal purposes.

17H3

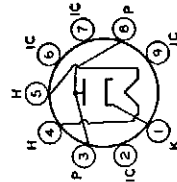

BEAM POWER TUBE

Glass octal type used as horizontal-deflection-amplifier tube in television receivers employing series-connected heater strings. Outline 14E, OUTLINES SECTION. Tube requires octal socket and may be operated in any position. Heater volts (ac/dc), 18.5; amperes, 0.3; warm-up time (average), 11 seconds. Characteristics as class A₁ amplifier: plate volts, 200; grid-No.2 volts, 125; grid-No.1 volts, -17; plate *ma.*, 40; grid-No.2 *ma.*, 1.1; transconductance, 4800 μ mhos; plate resistance (approx.), 27000 ohms.

18A5

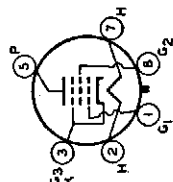

HORIZONTAL-DEFLECTION AMPLIFIER

For operation in a 525-line, 30-frame system

Triode Unit	Periodic Unit	Amplifier	Volts
Oscillator	250 <i>max</i>	3000 <i>max</i>	volts
DC PLATE VOLTAGE	250 <i>max</i>	—600 <i>max</i>	volts
PEAK POSITIVE-PULSE PLATE VOLTAGE*	—	160 <i>max</i>	volts
PEAK NEGATIVE-PULSE PLATE VOLTAGE	—	—250 <i>max</i>	volts
DC GRID-NO.2 (SCREEN-GRID) VOLTAGE	—	310 <i>max</i>	ma
PEAK NEGATIVE-PULSE GRID-NO.1 (CONTROL-GRID) VOLTAGE	—	90 <i>max</i>	ma
PEAK CATHODE CURRENT	—	2.5 <i>max</i>	watts
AVERAGE CATHODE CURRENT	—	—	—
GRID-NO.2 INPUT	—	9 <i>max</i>	watts
PEAK HEATER-CATHODE VOLTAGE:	200 <i>max</i>	200 <i>max</i>	volts
Heater negative with respect to cathode.	200* <i>max</i>	200* <i>max</i>	volts
Heater positive with respect to cathode.	—	—	—

Maximum Ratings, (Design-Maximum Values):

DC PLATE VOLTAGE	250 <i>max</i>	3000 <i>max</i>	volts
PEAK POSITIVE-PULSE PLATE VOLTAGE*	—	160 <i>max</i>	volts
PEAK NEGATIVE-PULSE PLATE VOLTAGE	—	—250 <i>max</i>	volts
DC GRID-NO.2 (SCREEN-GRID) VOLTAGE	—	310 <i>max</i>	ma
PEAK NEGATIVE-PULSE GRID-NO.1 (CONTROL-GRID) VOLTAGE	—	90 <i>max</i>	ma
PEAK CATHODE CURRENT	—	2.5 <i>max</i>	watts
AVERAGE CATHODE CURRENT	—	—	—
GRID-NO.2 INPUT	—	9 <i>max</i>	watts
PEAK HEATER-CATHODE VOLTAGE:	200 <i>max</i>	200 <i>max</i>	volts
Heater negative with respect to cathode.	200* <i>max</i>	200* <i>max</i>	volts
Heater positive with respect to cathode.	—	—	—

PEAK HEATER-CATHODE VOLTAGE:	200 <i>max</i>	volts
Heater negative with respect to cathode.	200* <i>max</i>	volts
Heater positive with respect to cathode.	190 <i>max</i>	volts
BULB TEMPERATURE (At hottest point)	—	°C

Maximum Circuit Value:

Grid-No.1-Circuit Resistance:	1 <i>max</i>	megohm
For grid-resistor-bias operation	—	—
# The duration of the voltage pulse must not exceed 15 per cent of one horizontal scanning cycle. In a 525-line, 30-frame system, 15 per cent of one horizontal scanning cycle is 10 microseconds.	—	—
Under no circumstances should this absolute value be exceeded.	—	—
• An adequate bias resistor or other means is required to protect the tube in the absence of excitation.	—	—
• The dc component must not exceed 100 volts.	—	—

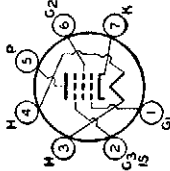

REMOTE-CUTOFF PENTODE

Miniature type used as rf- and if-amplifier tube in ac/dc radio receivers. Outline 7B, OUTLINES SECTION. Tube requires miniature seven-contact socket and may be mounted in any position. Heater volts (ac/dc), 18; amperes, 0.1; warm-up time (average), 18-FW6-A, 20 seconds.

18FW6
18FX6A

CLASS A₁ AMPLIFIER

Maximum Ratings, (Design-Maximum Values):

PLATE VOLTAGE	150 <i>max</i>	volts
GRID-NO.2 (SCREEN-GRID) SUPPLY VOLTAGE	150 <i>max</i>	volts
GRID-NO.2 VOLTAGE	See curve page 70	volts
GRID-NO.1 (CONTROL-GRID) VOLTAGE, Positive-bias value.	0 <i>max</i>	volts
GRID-NO.2 INPUT	0.6 <i>max</i>	watt
For grid-No.2 voltages up to 75 volts	See curve page 70	watts
For grid-No.2 voltages between 75 and 150 volts	2.5 <i>max</i>	watts
PLATE DISSIPATION	100 <i>max</i>	volts
PEAK HEATER-CATHODE VOLTAGE:	100 <i>max</i>	volts
Heater negative with respect to cathode.	—	—
Heater positive with respect to cathode.	—	—

Characteristics:

Plate Supply Voltage	100	volts
Grid No.3	Connected to cathode at socket	volts
Grid-No.2 Supply Voltage	100	volts
Cathode-Bias Resistor	68	ohms
Plate Resistance (Approx.)	0.25	megohm
Transconductance	4400	μ mhos
Plate Current	11	ma
Grid-No.2 Current	4.4	ma
Grid-No.1 Voltage (Approx.) for transconductance of 25 μ mhos	-20	volts

PENTAGRID CONVERTER

Miniature type used for converter applications in ac/dc radio receivers. Outline 7B, OUTLINES SECTION. Tube requires miniature seven-contact socket and may be mounted in any position. Heater volts (ac/dc), 18; amperes, 0.1; warm-up time (average), 18-FX6-A, 20 seconds.

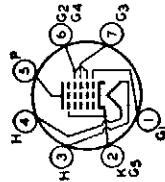

18FX6
18FX6A

CONVERTER

Maximum Ratings, (Design-Maximum Values):

PLATE VOLTAGE	150 <i>max</i>	volts
GRIDS-NO.2-AND-NO.4 (SCREEN-GRID) SUPPLY VOLTAGE	150 <i>max</i>	volts
GRIDS-NO.2-AND-NO.4 VOLTAGE	110 <i>max</i>	volts
GRIDS-NO.2-AND-NO.4 INPUT	1.2 <i>max</i>	watts

PLATE DISSIPATION..... 1 maz
PEAK HEATER-CATHODE VOLTAGE:
 Heater negative with respect to cathode..... 100 maz
 Heater positive with respect to cathode..... 100 maz

Typical Operation (Separate Excitation):*

Plate Voltage.....	100	volts
Grids-No.2-and-No.4 (Screen-Grid) Voltage.....	100	volts
Grid-No.3 (Control-Grid) Voltage.....	-1.5	volts
Grid-No.1 (Oscillator-Grid) Resistor.....	20000	ohms
Plate Resistance (Approx.).....	0.4	megohm
Conversion Transconductance.....	480	amhos
Grid-No.3 Voltage (Approx.) for conversion transconductance of 10 μ hos.....	-21	volts
Plate Current.....	2.3	ma
Grids-No.2-and-No.4 Current.....	6.2	ma
Grid-No.1 Current.....	0.5	ma
Total Cathode Current.....	9	ma

Note: The transconductance between grid No.1 and grids No.2 and No.4 connected to plate (not oscillating) is approximately 7000 amhos under the following conditions: grids No.1 and No.3 at 0 volts; and grids No.2 and No.4 and plate at 100 volts. Under the same conditions, the plate current is 24 ma., and the amplification factor is 22.

* The characteristics shown with separate excitation correspond very closely with those obtained in a self-excited oscillator circuit operating with zero bias.

TWIN DIODE—HIGH-MU TRIODE

Miniature type used for combined detector, amplifier, and aye tube in compact ac/dc radio receivers. Outline 7B, OUTLINESSECTION. Tube requires miniature seven-contact socket and may be mounted in any position. Heater volts (ac/dc), 18; amperes, 0.1; warm-up time (average), 18FY6-A, 20 seconds.

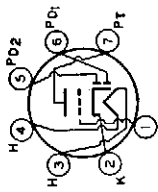

TRIODE UNIT AS CLASS A₁ AMPLIFIER

Maximum Ratings, (Design-Maximum Values):

PLATE VOLTAGE.....	150 maz	volts
GRID VOLTAGE, Positive-bias value.....	0 maz	volts
PLATE DISSIPATION.....	0.5 maz	watt
PEAK HEATER-CATHODE VOLTAGE: Heater negative with respect to cathode.....	100 maz	volts
Heater positive with respect to cathode.....	100 maz	volts

Characteristics:

Plate Voltage.....	100	volts
Grid Voltage.....	-1	volt
Amplification Factor.....	100	
Plate Resistance (Approx.).....	77000	ohms
Transconductance.....	1300	amhos
Plate Current.....	0.6	ma

DIODE UNITS (Each Unit)

Maximum Ratings, (Design-Maximum Values):

PLATE CURRENT.....	1 maz	ma
--------------------	-------	----

SHARP-CUTOFF PENTODE

Miniature type used in the if, rf, and converter stages of ac/dc AM radio receivers. Outline 7B, OUTLINESSECTION. Tube requires miniature seven-contact socket and may be operated in any position.

18GD6A

HEATER VOLTAGE (AC/DC)..... 18 volts
HEATER CURRENT..... 0.1 ampere
WARM-UP TIME (AVERAGE)..... 20 seconds

DIRECT INTERELECTRODE CAPACITANCES:
 Grid-No.1 to Plate..... 0.0035 pf
 Grid No.1 to Cathode, Heater, Grid No.2, Grid No.3, and Internal Shield..... 6.0 pf
 Plate to Cathode, Heater, Grid No.2, Grid No.3 and Internal Shield..... 5.0 pf
 * Values are same without external shield, or with external shield connected to cathode.

CLASS A₁ AMPLIFIER

Characteristics:

Plate Supply Voltage.....	100	volts
Grid No.3 (Suppressor Grid).....	Connected to cathode at socket	
Grid-No.2 (Screen-Grid) Voltage.....	100	volts
Cathode-Bias Resistor.....	150	ohms
Plate Resistance (Approx.).....	0.5	megohm
Transconductance.....	4300	amhos
Plate Current.....	5	ma
Grid-No.2 Current.....	2	ma
Grid-No.1 Voltage (Approx.), for plate current of 10 μ A.....	-4.7	volts

RF AMPLIFIER AND CONVERTER

Maximum Ratings, (Design-Maximum Values):

PLATE VOLTAGE.....	150 maz	volts
GRID-NO.2 SUPPLY VOLTAGE.....	150 maz	volts
GRID-NO.2 VOLTAGE.....	See curve page 70	
PLATE DISSIPATION.....	2.5 maz	watts
GRID-NO.2 INPUT: For grid-No.2 voltages up to 75 volts.....	0.6 maz	watt
For grid-No.2 voltages between 75 and 150 volts.....	See curve page 70	
PEAK HEATER-CATHODE VOLTAGE: Heater negative with respect to cathode.....	100 maz	volts
Heater positive with respect to cathode.....	100 maz	volts

HIGH-MU TWIN POWER TRIODE

Glass type used in output stage of battery-operated receivers. Maximum dimensions: overall length, 4-3/16 inches; seated height, 3-9/16 inches; diameter, 1-9/16 inches. Tube requires six-contact socket. Filament volts (dc), 2.0; amperes, 0.26. Except for filament current, this type is electrically identical with type 19A-U-T. Type 19 is a DISCONTINUED type listed for reference only.

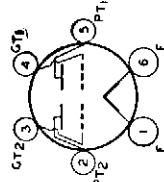

HALF-WAVE VACUUM RECTIFIER

Glass octal types used as damper diode in horizontal-deflection circuits of black-and-white television receivers employing series-connected heater strings. Outline 14F, OUTLINESSECTION.

19AU4
19AU4GTA

Related types:
 6AU4GTA

Tubes require octal socket and may be mounted in any position. These types may be supplied with pin 1 omitted. Socket terminals 1, 2, 4, and 6 should not be used as tie points. It is especially important that these tubes, like other power-handling tubes, be adequately ventilated. Heater volts (ac/dc), 18.9; amperes, 0.6; warm-up time (average), 11 seconds. Type 19AU4-GTA is used principally for renewal purposes.

DAMPER SERVICE

For operation in a 525-line, 30-frame system

19AU4-GTA		19AU4	
Design Maximum Design Center			
PEAK INVERSE PLATE VOLTAGE.....	4500 ^o maz	4500 ^o maz	volts
PEAK PLATE CURRENT.....	1300 maz	1050 maz	ma
DC PLATE CURRENT.....	210 maz	175 maz	ma
PLATE DISSIPATION.....	6.5 maz	6	watts
PEAK HEATER-CATHODE VOLTAGE: Heater negative with respect to cathode.....	4500 ^o maz	4500 ^o maz	volts
Heater positive with respect to cathode.....	300 ^o maz	300 ^o maz	volts

† The duration of the voltage pulse must not exceed 15 per cent of one horizontal scanning cycle. In a 525-line, 30-frame system, 15 per cent of one horizontal scanning cycle is 10 microseconds.
 ‡ Under no circumstances should this absolute value be exceeded.
 § The dc component must not exceed 900 volts.
 ¶ The dc component must not exceed 100 volts.

BEAM POWER TUBE

Glass octal types used as output amplifiers in horizontal deflection circuits of television equipment of the "transformerless" type where high pulse voltages occur during short duty cycles. Type 19BG6GA, Outline 25A, OUTLINES SECTION. Tubes require octal socket. Vertical tube mounting is preferred, but horizontal operation is permissible if pins No.2 and No.7 are in vertical plane. Heater volts (ac/dc), 18.9; amperes, 0.3. Except for heater rating and interelectrode capacitances, type 19BG6-GA is electrically identical with glass octal type 6BG6-G. Type 19BG6-G is a DISCONTINUED type listed for reference only. Type 19BG6-GA is used principally for renewal purposes.

19BG6G

19BG6GA

Related types:
6BG6G

18.9; amperes, 0.3. Except for heater rating and interelectrode capacitances, type 19BG6-GA is electrically identical with glass octal type 6BG6-G. Type 19BG6-G is a DISCONTINUED type listed for reference only. Type 19BG6-GA is used principally for renewal purposes.

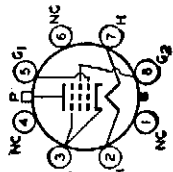

**MEDIUM-MU TRIODE—
SHARP-CUTOFF TETRODE**

Miniature type used as combined vhf oscillator and mixer in television receivers employing series-connected heater strings. Outline 8B, OUTLINES SECTION. Tube requires miniature nine-contact socket and may be operated in any position. Heater volts (ac/dc), 18.9; amperes, 0.15; warm-up time (average), 11 seconds. Except for heater ratings, this type is identical with miniature type 6CL8-A.

19CL8A

Related types:
5CLA, 6CLA

Miniature type used as combined vhf oscillator and mixer in television receivers employing series-connected heater strings. Outline 8B, OUTLINES SECTION. Tube requires miniature nine-contact socket and may be operated in any position. Heater volts (ac/dc), 18.9; amperes, 0.15; warm-up time (average), 11 seconds. Except for heater ratings, this type is identical with miniature type 6CL8-A.

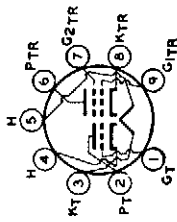

**MEDIUM-MU TRIODE—
SHARP-CUTOFF PENTODE**

Miniature type used as combined oscillator and mixer in television receivers employing series-connected heater strings and using an intermediate frequency in the order of 40 megacycles per second. Outline 8B, OUTLINES SECTION. Tube requires miniature nine-contact socket and may be operated in any position. Heater volts (ac/dc), 18.9; amperes, 0.15; warm-up time (average), 11 seconds. Except for heater ratings, this type is identical with miniature type 6EA8.

19EA8

Related types:
5EA8, 6EA8

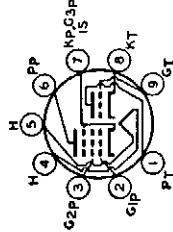

SEMIREMOTE-CUTOFF PENTODE

Miniature type used as if-amplifier tube in FM receivers employing series-connected heater strings. Outline 7B, OUTLINES SECTION. Heater volts (ac/dc), 18.9; amperes, 0.15; warm-up time (average), 17 seconds. Except for heater ratings, this type is identical with miniature type 6HR6.

19HR6

Related types:
4HR6

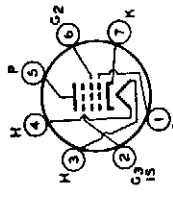

SHARP-CUTOFF PENTODE

Miniature type used as if-amplifier and limiter tube in FM receivers. Outline 7B, OUTLINES SECTION. Heater volts (ac/dc), 18.9; amperes, 0.15; warm-up time (average), 17 seconds. Except for heater ratings, this type is identical with miniature type 6HS6.

19HS6

Related types:
4HS6

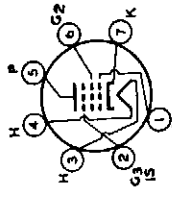

**HIGH-MU TRIODE—
SHARP-CUTOFF PENTODE**

Miniature type used as if-amplifier and af voltage-amplifier tube in radio receivers employing series-connected heater strings. Outline 8B, OUTLINES SECTION. Tube requires miniature nine-contact socket and may be mounted in any position. Heater volts (ac/dc), 18.9; amperes, 0.15.

19HV8

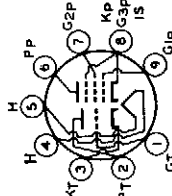

CLASS A₁ AMPLIFIER

Maximum Ratings, (Design-Maximum Values):

PLATE VOLTAGE.....	Triode Unit	Pentode Unit
GRID-NO.2 (SCREEN-GRID) SUPPLY VOLTAGE.....	330 max	330 max
GRID-NO.2 VOLTAGE.....	—	330 max
GRID-NO.1 (CONTROL-GRID) VOLTAGE, Positive-bias value.....	—	See curve page 70
GRID-NO.2 INPUT.....	0.55 max	0.55 max
PEAK HEATER-CATHODE VOLTAGE.....	—	0.55 max
Heater negative with respect to cathode.....	—	See curve page 70
Heater positive with respect to cathode.....	200 max	200 max
	200 ^{max}	200 ^{max}

Characteristics:

Plate Voltage.....	100	125
Grid-No.2 Voltage.....	—	125
Grid-No.1 Voltage.....	70	—
Amplification Factor.....	54000	200000
Plate Resistance (Approx.).....	1300	6500
Transconductance.....	0.8	12
Plate Current.....	—	4
Grid-No.2 Current.....	—	—
Grid-No.1 Voltage (Approx.) for plate current of 50 μ a.....	—1.5	—
Grid-No.1 Voltage (Approx.) for plate current of 20 μ a.....	—	—
Maximum Circuit Values:		
For fixed-bias operation.....	0.5 max	0.25 max
For cathode-bias operation.....	1 max	1 max

The ac component must not exceed 100 volts.

MEDIUM-MU TWIN TRIODE

Miniature type used for converter service in ac/dc AM and FM receivers and as oscillator, amplifier, or mixer in television receivers of the "transformerless" type. Outline 7B, OUTLINES SECTION. Tube requires miniature seven-contact socket and may be mounted in any position. Heater volts (ac/dc), 18.9; amperes, 0.15. For direct interelectrode capacitances, ratings, and typical operation as a class A₁ amplifier, and curves, refer to type 6J6. Maximum ratings and characteristics for mixer service (each unit): plate volts, 150 (300 max); cathode-bias resistor, 810 ohms; peak oscillator volts, 3; plate resistance, 10200 ohms; conversion transconductance, 1900 μ mhos; plate ma., 4.8; plate dissipation, 1.5 max watts; peak heater-cathode volts, 90 max. Type 19J6 is used principally for renewal purposes.

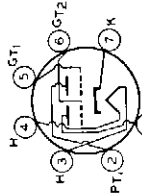

19J6

Related types:
5J6, 6J6

**MEDIUM-MU TRIODE—
SHARP-CUTOFF PENTODE**

Miniature type used as FM converter and rf-amplifier tube in radio receivers. Outline 8B, OUTLINES SECTION. Tube requires miniature nine-contact socket and may be mounted in any position. Heater volts (ac/dc), 18.9; amperes, 0.15.

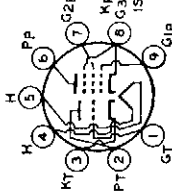

19JN8

CLASS A₁ AMPLIFIER

Maximum Ratings, (Design-Maximum Values):

PLATE VOLTAGE.....	300 max	Pentode Unit	300 max	volts
GRID-NO.2 (SCREEN-GRID) SUPPLY VOLTAGE.....	300 max	Unit	300 max	volts
GRID-NO.2 VOLTAGE.....	See curve page 70			volts
GRID-NO.1 (CONTROL-GRID) VOLTAGE, Positive-bias value.....	0 max			volts
PLATE DISSIPATION.....	2.5 max			watts
GRID-NO.2 INPUT.....	0.55 max			watt
For grid-No.2 voltages up to 150 volts.....	See curve page 70			
For grid-No.2 voltages between 150 and 300 volts.....				
PEAK HEATER-CATHODE VOLTAGE.....	200 max			volts
Heater negative with respect to cathode.....	200 max			volts
Heater positive with respect to cathode.....	200 max			volts
Characteristics:				
Plate Resistance.....	125			volts
Grid-No.2 Voltage.....	125			volts
Grid-No.1 Voltage.....	-1			volt
Amplification Factor.....	46			
Plate Resistance (Approx.).....	5400			ohms
Transconductance.....	8500			amhos
Plate Current.....	12			ma
Grid-No.2 Current.....	4			ma
Grid-No.1 Voltage (Approx.) for plate current of 10 μ a.....	-8			volts

Maximum Circuit Values:

Grid-No.1-Circuit Resistance:	2.2 max	2.2 max	megohms
For fixed-bias operation.....	2.2 max	2.2 max	megohms
For cathode-bias operation.....			

■ The dc component must not exceed 100 volts.

TRIPLE DIODE—HIGH-MU TRIODE

Miniature type used as combined audio amplifier, AM detector, and FM detector in AM/FM receivers of the a/c or "transformer" type. Outline 8B, OUTLINES SECTION. Tube requires miniature nine-contact socket and may be mounted in any position. Heater volts (ac/dc), 18.9; amperes, 0.15. Except for heater ratings, this type is identical with miniature type 6T8-A. Type 19T8 is used principally for newal purposes.

19T8

Related types:
5T8, 6T8A

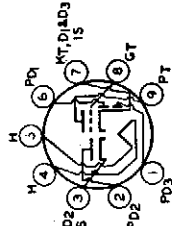

MEDIUM-MU TRIODE—SHARP-CUTOFF PENTODE

Miniature type used as combined oscillator and mixer tube in "transformerless" AM/FM receivers. Outline 8B, OUTLINES SECTION. Tube requires miniature nine-contact socket and may be mounted in any position. Heater volts (ac/dc), 18.9; amperes, 0.15. Except for heater ratings, this type is identical with miniature type 6X8.

19X8

Related types:
5X8, 6X8

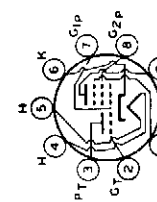

POWER TRIODE

Glass type used as output amplifier in dry-battery-operated receivers. Filament volts (dc), 3.3; amperes, 0.132. Characteristics as class A₁ amplifier: plate volts, 135 max; grid volts, -22.5; plate ma., 6.5; plate resistance, 6300 ohms; amplification factor, 3.3; transconductance, 525 μ ohms; load resistance, 6500 ohms; output mv., 110. This is a DISCONTINUED type listed for reference only.

20

DIODE—REMOTE-CUTOFF PENTODE

Miniature type used as combined amplifier and AM detector in AM and AM/FM radio receivers. Outline 8D, OUTLINES SECTION. Tube requires miniature nine-contact socket and may be operated in any position. Heater volts (ac/dc), 20; amperes, 0.1. Except for heater ratings, this type is identical with miniature type 6EQ7.

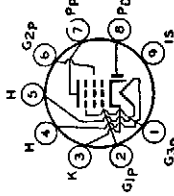

20EQ7

Related types:
6EQ7, 12EQ7

HIGH-MU TWIN TRIODE

Miniature type used in high-gain, resistance-coupled, low-level audio amplifiers operating at low-signal levels, such as preamplifiers for stereo phonographs. Outline 8B, OUTLINES SECTION. For typical operation as resistance-coupled amplifier, refer to RESISTANCE-COUPLED AMPLIFIER SECTION. Tube requires miniature nine-contact socket and may be operated in any position.

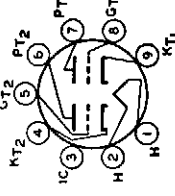

20EZ7

HEATER VOLTS (AC/DC).....	20	volts
HEATER CURRENT.....	0.1	ampere
HEATER WARM-UP TIME (AVERAGE).....	20	seconds
DIRECT INTERELECTRODES CAPACITANCES:		
Grid to Plate.....	Unit No.1	1.5 pf
Grid to Cathode and Heater.....	Unit No.2	1.6 pf
Plate to Cathode and Heater.....		0.3 pf

CLASS A₁ AMPLIFIER (Each Unit)

Maximum Ratings, (Design-Maximum Values):

PLATE VOLTAGE.....	330 max	volts
GRID VOLTAGE.....	55 max	volts
Negative-bias value.....	0 max	volts
Positive-bias value.....	1.2 max	watts
PLATE DISSIPATION.....	200 max	volts
PEAK HEATER-CATHODE VOLTAGE.....	200 max	volts
Heater negative with respect to cathode.....		
Heater positive with respect to cathode.....		

AVERAGE PLATE CHARACTERISTICS

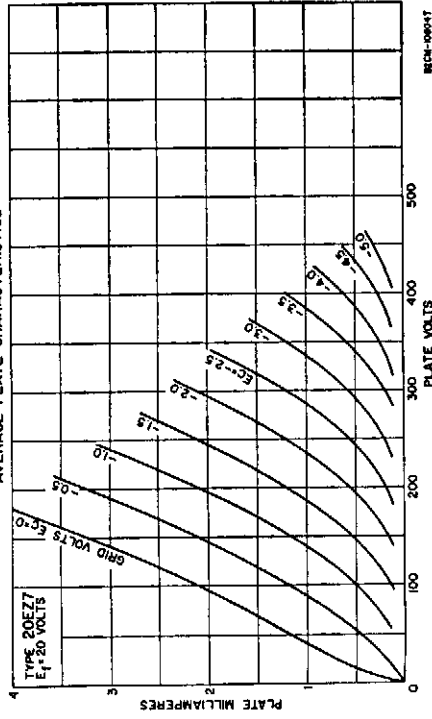

Characteristics:

Plate Voltage.....	100	volts
Grid Voltage.....	-1	volts
Amplification Factor.....	100	ohms
Plate Resistance (Approx.).....	80000	μohms
Transconductance.....	1250	ma
Plate Current.....	0.5	ma

o Without external shield.

■ The dc component must not exceed 100 volts.

21EX6

Related type:
6EX6

BEAM POWER TUBE

Glass octal type used as horizontal-deflection amplifier in television receivers employing series-connected heater strings. Outline 25A, OUTLINES SECTION. Tubes requires octal socket and should be operated vertically (base down or up) or horizontally with pins 2 and 7 in a vertical plane. Heater volts (ac/dc), 21-5; amperes; warm-up time (average), 11 seconds. Except for heater ratings, this tube is identical with glass octal type 6EX6.

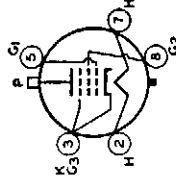

tal socket and should be operated vertically (base down or up) or horizontally with pins 2 and 7 in a vertical plane. Heater volts (ac/dc), 21-5; amperes; warm-up time (average), 11 seconds. Except for heater ratings, this tube is identical with glass octal type 6EX6.

21GY5

BEAM POWER TUBE

Duodecar type used as horizontal-deflection amplifier tube in television receivers employing series-connected heater strings. Outline 16C, OUTLINES SECTION. Tube requires duodecar twelve-contact socket and may be mounted in any position. Heater volts (ac/dc), 21; amperes, 0.45; warm-up time (average), 11 seconds.

BEAM POWER TUBE

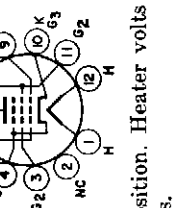

Maximum Circuit Values:

- Grid-No.1-Circuit Resistance..... 1 *maz* megohm
- # The duration of the voltage pulse must not exceed 15 per cent of one horizontal scanning cycle. In a 525-line, 30-frame system, 15 per cent of one horizontal scanning cycle is 10 microseconds.
- † An adequate bias resistor or other means is required to protect the tube in the absence of excitation.
- The dc component must not exceed 100 volts.

SHARP-CUTOFF TETRODE

Glass type used as rf amplifier in dry-battery-operated receivers. Maximum over-all length, 5-1/32 inches; maximum diameter, 1-13/16 inches. Filament volts (dc), 3.3; amperes, 0.132. Characteristics as class A₁ amplifier: plate volts, 135 *maz*; grid-No.2 (screen-grid) volts, 67.5 *maz*; grid-No.1 volts, -1.5; plate ma., 3.7; grid-No.2 ma., 1.3; plate resistance, 325000 ohms; transconductance, 500 μmhos. This is a DISCONTINUED type listed for reference only.

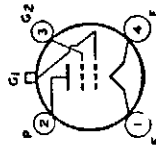

HALF-WAVE VACUUM RECTIFIER

Novar type used as damper tube in horizontal deflection circuits of black-and-white television receivers employing series-connected heater strings. Outline 17A, OUTLINES SECTION.

22BH3

Related types:
6BH3, 17BH3

Heater volts (ac/dc), 22.4; amperes, 0.45; warm-up time (average), 11 seconds. Except for heater ratings, this type is identical with novar type 6BH3.

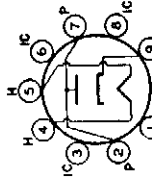

HALF-WAVE VACUUM RECTIFIER

Glass octal type used as damper tube in horizontal-deflection circuits of black-and-white television receivers employing series-connected heater strings. Outline 14F, OUTLINES SECTION.

22DE4

Related types:
6DE4, 17DE4

Heater volts (ac/dc), 22.4; amperes, 0.45; warm-up time (average), 11 seconds. Except for heater ratings, this type is identical with glass octal type 6DE4.

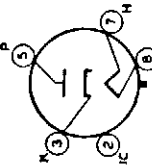

BEAM POWER TUBE

Novar type used as horizontal-deflection amplifier tube in low-B+, black-and-white television receivers employing series-connected heater strings. Outline 17A, OUTLINES SECTION.

22JG6

Tube requires novar nine-contact socket and may be mounted in any position.

HEATER VOLTAGE (AC DC).....	22	volts
HEATER CURRENT.....	0.45	ampere
HEATER WARM-UP TIME (AVERAGE).....	11	seconds
DIRECT INTERELECTRODE CAPACITANCES (Approx.):		
Grid No.1 to Plate.....	0.7	pf
Grid No.1 to Cathode, Heater, Grid No.2, and Grid No.3.....	22	pf
Plate to Cathode, Heater, Grid No.2, and Grid No.3.....	9	pf

CLASS A₁ AMPLIFIER

Characteristics:	Triode^o	Pentode
Plate Voltage.....	125	130
Grid No.3 (Suppressor Grid).....	Connected to cathode at socket	
Grid-No.2 (Screen-Grid) Voltage.....	-20	0
Grid-No.1 (Control-Grid) Voltage.....		

HORIZONTAL-DEFLECTION AMPLIFIER

For operation in a 525-line, 30-frame system

(Design-Maximum Values):

Maximum Ratings, (Design-Maximum Values):		
DC PLATE SUPPLY VOLTAGE.....	770 <i>maz</i>	volts
PEAK POSITIVE-PULSE PLATE VOLTAGE ^o	6500 <i>maz</i>	volts
PEAK NEGATIVE-PULSE PLATE VOLTAGE.....	-1500 <i>maz</i>	volts
GRID-NO.2 VOLTAGE.....	220 <i>maz</i>	volts
PEAK NEGATIVE-PULSE GRID-NO.1 VOLTAGE.....	-65 <i>maz</i>	volts
DC GRID-NO.1 VOLTAGE.....	800 <i>maz</i>	ma
PEAK CATHODE CURRENT.....	230 <i>maz</i>	ma
AVERAGE CATHODE CURRENT.....	18 <i>maz</i>	ma
PLATE DISSIPATION.....	3.5 <i>maz</i>	watts
GRID-NO.2 INPUT.....		
PEAK HEATER-CATHODE VOLTAGE.....	200 <i>maz</i>	volts
Heater negative with respect to cathode.....	200 <i>maz</i>	volts
Heater positive with respect to cathode.....	220 <i>maz</i>	volts
BULB TEMPERATURE (At hottest point).....		°C

CLASS A₁ AMPLIFIER

Characteristics:		
Plate Voltage.....	60	volts
Grid-No.2 (Screen-Grid) Voltage.....	130	volts
Grid-No.1 (Control-Grid) Voltage.....	0	volts
Triode Amplification Factor*.....	4.7	
Plate Resistance (Approx.).....	11000	ohms
Transconductance.....	9100	μmhos
Plate Current.....	50	ma
Grid-No.2 Current.....	24*	ma
Grid-No.1 Voltage (Approx.) for plate current of 1 ma.....	-33	volts

* Triode connection, grid No.2 connected to plate.

• This value can be measured by a method involving a recurrent waveform such that the maximum ratings of the tube will not be exceeded.

BEAM POWER TUBE

25AV5GA
 Related types:
 6AV5GA, 12AV5GA

Glass octal type used as horizontal-deflection amplifier tube in television receivers employing either transformer coupling or direct coupling to the deflecting yoke. Outline 19B, OUTLINES SECTION. Heater volts (ac/dc), 25; amperes, 0.3. Except for heater ratings, this type is identical with glass octal type 6AV5-GA.

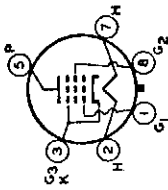

HALF-WAVE VACUUM RECTIFIER

25AX4GT
 Related types:
 6AX4GT, 6AX4GTB,
 12AX4GTA, 12AX4GTB,
 17AX4GT, 17AX4GTA

Glass octal type used as a damper tube in horizontal deflection circuits of television receivers. Outline 14C, OUTLINES SECTION. This type may be supplied with pin No.1 omitted. Heater volts (ac/dc), 25; amperes, 0.3. Except for heater ratings, this type is identical with glass octal type 6AX4-GT.

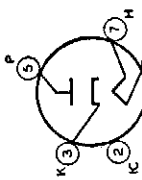

DIRECT-COUPLED POWER AMPLIFIER

25B5

Glass type used as class A₁ power amplifier. One triode, the driver, is directly connected within the tube to the second, or output, triode. Heater volts (ac/dc), 25; amperes, 0.3. Maximum ratings and characteristics are the same as for type 25N6-G. Type 25B5 is a DISCONTINUED type listed for reference only.

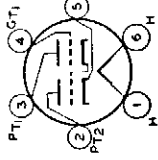

TRIODE—PENTODE

25B8GT

Glass octal type used as amplifier. High-mu triode unit and remote-cutoff pentode unit are independent. Outline 14C, OUTLINES SECTION. Heater volts (ac/dc), 25; amperes, 0.15. Typical operation of pentode unit as class A₁ amplifier: plate and grid-No.2 volts, 100; grid-No.1 volts, -3; plate ma., 7.6; grid-No.2 ma., 2; plate resistance, 185000 ohms; transconductance unit: plate volts, 100; grid volts, -1; plate ma., 0.6; amplification factor, 112; transconductance, 1500 μ mbos. This is a DISCONTINUED type listed for reference only.

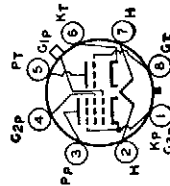

POWER PENTODE

25B6G

Glass octal type used in output stage of ac/dc receivers. Outline 26, OUTLINES SECTION. Heater volts (ac/dc), 25; amperes, 0.3. Typical operation as class A₁ amplifier: plate volts, 200 max; grid-No.2 volts, 135 max; grid-No.1 volts, -23; plate ma., 62; grid-No.2 ma., 1.8; plate resistance, 18000 ohms; transconductance, 5000 μ mbos; load resistance, 2500 ohms; output watts, 7.1. This is a DISCONTINUED type listed for reference only.

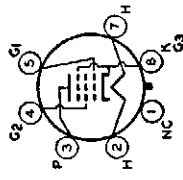

BEAM POWER TUBE

25BK5
 Related types:
 6BK5, 12BK5

Miniature type used in audio output stages of television and radio receivers. Also used as video amplifier. Outline 8D, OUTLINES SECTION. Heater volts (ac/dc), 25; amperes, 0.8. Except for heater rating, this type is identical with miniature type 6BK5.

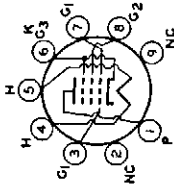

BEAM POWER TUBE

25BQ6GT
25BQ6GTB
/25CU6
 Related types:
 6BQ6GTB/6CU6, 12BQ6GTB
 GTB/12CU6, 17BQ6GTB

Glass octal types used as horizontal deflection amplifiers in circuits of television equipment. Outline 15C, OUTLINES SECTION. These types may be supplied with pin No.1 omitted. Tubes require octal socket and may be mounted in any position. Heater volts (ac/dc), 25; amperes, 0.3. Except for heater rating, these types are identical with glass octal types 6BQ6-GT and 6BQ6-GTB/6CU6, respectively. Type 25BQ6-GT is a DISCONTINUED type listed for reference only.

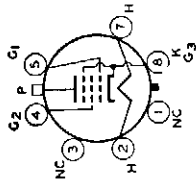

BEAM POWER TUBE

25C5
 Related type:
 50C5

Miniature type used in the audio output stage of radio receivers. Because of its high power sensitivity and high efficiency at low plate and screen-grid voltages, it is capable of providing a relatively high power output. Outline 7C, OUTLINES SECTION. Tube requires miniature seven-contact socket and may be mounted in any position. Heater volts (ac/dc), 25; amperes, 0.3. Except for heater ratings, this type is identical with miniature type 50C5.

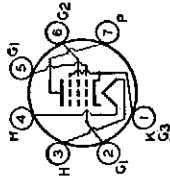

BEAM POWER TUBE

25C6G

Glass octal type used as output amplifier. Outline 26, OUTLINES SECTION. Heater volts (ac/dc), 25; amperes, 0.3. Refer to type 6Y6-G for typical operation as a class A₁ amplifier. Type 25C6-G is a DISCONTINUED type listed for reference only.

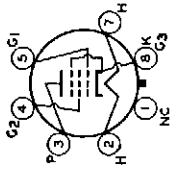

BEAM POWER TUBE

25CA5
 Related types:
 6CA5, 12CA5

Miniature type used in audio-output stage of radio and television receivers. Outline 7C, OUTLINES SECTION. Heater volts (ac/dc), 25; amperes, 0.3. Except for heater ratings, this type is identical with miniature type 12CA5.

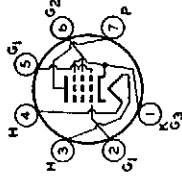

BEAM POWER TUBE

25CD6GA
25CD6GB
 Related type:
 6CD6GA

Glass octal types used as horizontal deflection amplifiers in television receivers employing series-connected heater strings. Type 25CD6-GB, Outline 25A, OUTLINES SECTION. Heater volts (ac/dc), 25; amperes, 0.6; warm-up time (average), 11 seconds. Except for heater ratings, these types are identical with glass octal types 6CD6-G and 6CD6-GA, respectively. Type 25CD6-GA is a DISCONTINUED type listed for reference only.

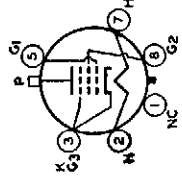

Refer to type 25BQ6GTB/25CU6

25CU6

25DN6

BEAM POWER TUBE

Glass octal type used as horizontal deflection amplifier in television receivers employing series-connected heater strings. Outline, 25A, OUTLINES SECTION. Tube requires vertical tube mounting is preferred but horizontal operation is permissible if pins 1 and 3 are in vertical plane.

HEATER VOLTAGE (AC/DC)	25	volts
HEATER CURRENT	0.6	ampere
HEATER WARM-UP TIME (Average)	11	seconds
PLATE RESISTANCE (Approx.)†	4000	ohms
TRANSCONDUCTANCE	9000	μmhos
MC-FACTOR, j Grid No.2 to Grid No.1	4.35	

† For plate and grid-No.2 volts, 125; grid-No.1 volts, -18; plate ma., 70; grid-No.2 ma., 6.3.

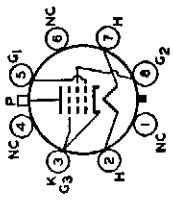

HORIZONTAL DEFLECTION AMPLIFIER

For operation in a 525-line, 30-frame system

DC PLATE VOLTAGE	700 max	volts
PEAK POSITIVE-PULSE PLATE VOLTAGE# (Absolute Maximum)	6800-max	volts
PEAK NEGATIVE-PULSE PLATE VOLTAGE	1500 max	volts
DC GRID-No.2 (SCREEN-GRID) VOLTAGE	175 max	volts
PEAK NEGATIVE-PULSE GRID-No.1 (CONTROL-GRID) VOLTAGE	-200 max	volts
PEAK CATHODE CURRENT	700 max	ma
AVERAGE CATHODE CURRENT	200 max	ma
GRID-No.2 INPUT	3 max	watts
PLATE DISSIPATION†	15 max	watts
PEAK HEATER-CATHODE VOLTAGE:		
Heater negative with respect to cathode	200 max	volts
Heater positive with respect to cathode	200-max	volts
BULB TEMPERATURE (At hottest point)	225 max	°C

Maximum Circuit Value:
 Grid-No.1-Circuit Resistance..... 0.47 max megohm
 † The duration of the voltage pulse must not exceed 15 per cent of one horizontal scanning cycle. In a 525-line, 30-frame system, 15 per cent of one horizontal scanning cycle is 10 microseconds.
 ‡ Under no circumstances should this absolute value be exceeded.
 † An adequate bias resistor or other means is required to protect the tube in the absence of excitation.
 ‡ The dc component must not exceed 100 volts.

BEAM POWER TUBE

Glass octal type used as horizontal deflection amplifier in television receivers employing series-connected heater strings. Outline 25A, OUTLINES SECTION, except vertical dimensions are 1/4 inch shorter. Tube requires octal socket and may be operated in any position.

HEATER VOLTAGE (AC/DC)	25	volts
HEATER CURRENT	0.6	ampere
WARM-UP TIME (AVERAGE)	11	seconds
DIRECT INTERELECTRODE CAPACITANCES:		
Grid No.1 to Plate	0.6	pf
Grid No.1 to Cathode, Heater, Grid No.3, and Grid No.2	24	pf
Plate to Cathode, Heater, Grid No.3, and Grid No.2	10	pf

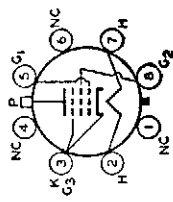

CLASS A₁ AMPLIFIER

Characteristics:

Plate Voltage	60	volts
Grid-No.2 (Screen-Grid) Voltage	135	volts
Grid-No.1 (Control-Grid) Voltage	0	volts
Triode Amplification Factor	3.8	

25EC6

Plate Resistance (Approx.)	4700	ohms
Transconductance	7500	μmhos
Plate Current	70	ma
Grid-No.2 Current	4.5	ma
Grid-No.1 Voltage (Approx.) for plate current of 1 ma	-42	volts

HORIZONTAL-DEFLECTION AMPLIFIER

For operation in a 525-line, 30-frame system

DC PLATE SUPPLY VOLTAGE	700 max	volts
PEAK POSITIVE-PULSE PLATE VOLTAGE*	7000 max	volts
PEAK NEGATIVE-PULSE PLATE VOLTAGE	-1500 max	volts
DC GRID-No.2 VOLTAGE	175 max	volts
PEAK NEGATIVE-PULSE GRID-No.1 VOLTAGE	-300 max	volts
AVERAGE CATHODE CURRENT	700 max	ma
GRID-No.2 INPUT	4 max	watts
PLATE DISSIPATION†	10 max	watts
PEAK HEATER-CATHODE VOLTAGE:		
Heater negative with respect to cathode	200 max	volts
Heater positive with respect to cathode	200-max	volts
BULB TEMPERATURE (At hottest point)	225 max	°C

Maximum Circuit Values:

Grid-No.1-Circuit Resistance..... 1.5 max megohms
 † This value can be measured by a method involving a recurrent waveform such that the maximum ratings of the tube will not be exceeded.
 ‡ This rating is applicable where the duration of the voltage pulse does not exceed 15 per cent of the horizontal scanning cycle. In a 525-line, 30-frame system, 15 per cent of the horizontal scanning cycle is 10 microseconds.
 † An adequate bias resistor or other means is required to protect the tube in the absence of excitation.
 ‡ The dc component must not exceed 100 volts.

POWER PENTODE

Miniature type used in the audio output stage of radio and television receivers and in phonographs. Outline 7C, OUTLINES SECTION. Heater volts (ac/dc), 25; amperes, 0.3. Except for heater rating, this type is identical with miniature type 6EH5.

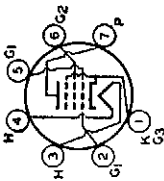

25EH5

Related types:
 6EH5, 12EH5, 50EH5

BEAM POWER TUBE

Miniature type used in audio-output stage of ac/dc radio receivers employing series-connected heater strings. Outline 7C, OUTLINES SECTION. Tube requires miniature seven-contact socket and may be mounted in any position.

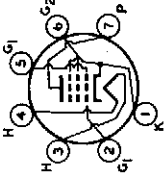

25F5A

HEATER VOLTAGE (AC/DC)	25	volts
HEATER CURRENT	0.15	ampere
HEATER WARM-UP TIME (AVERAGE)	17	seconds
DIRECT INTERELECTRODE CAPACITANCES (Approx.):		
Grid No.1 to Plate	0.44	pf
Grid No.1 to Cathode, Heater, Grid No.2, and Grid No.3	12	pf
Plate to Cathode, Heater, Grid No.2, and Grid No.3	8	pf

CLASS A₁ AMPLIFIER

Maximum Ratings, (Design-Maximum Values):

Plate Voltage	150 max	volts
Grid-No.2 (SCREEN-GRID) VOLTAGE	130 max	volts
Grid-No.1 (CONTROL-GRID) VOLTAGE, Positive-bias value	0 max	volts
PLATE DISSIPATION	5.5 max	watts
GRID-No.2 INPUT	1.1 max	watts

PEAK HEATER-CATHODE VOLTAGE:

- Heater negative with respect to cathode.....
- Heater positive with respect to cathode.....
- BULB TEMPERATURE (At hottest point)**.....

200 *max*
200 *max*
220 *max*
volts
volts
°C

Typical Operation and Characteristics:

- Plate Voltage.....
- Grid-No.2 Voltage.....
- Grid-No.1 Voltage.....
- Peak AF Grid-No.1 Voltage.....
- Plate Resistance (Approx.).....
- Transconductance.....
- Zero-Signal Plate Current.....
- Maximum-Signal Plate Current.....
- Zero-Signal Grid-No.2 Current.....
- Maximum-Signal Grid-No.2 Current.....
- Effective Load Resistance.....
- Total Harmonic Distortion.....
- Maximum-Signal Power Output.....

110
110
-7.5
7.5
13000
6400
43
45
3.8
7.3
2500
7
1.5
volts
volts
volts
volts
ohms
μhos
ma
ma
ma
ma
ohms
per cent
watts

Maximum Circuit Values:

- Grid-No.1-Circuit Resistance:
For fixed-bias operation.....
- For cathode-bias operation.....

0.1 *max*
0.5 *max*
megohm
megohm

PUSH-PULL CLASS AB₁ AMPLIFIER

(Same as for Class AB₁ amplifier)

Typical Operation (Values are for two tubes):

- Plate Voltage.....
- Grid-No.2 Voltage.....
- Grid-No.1 Voltage.....
- Peak AF Grid-No.1-to-Grid-No.1 Voltage.....
- Zero-Signal Plate Current.....
- Maximum-Signal Plate Current.....
- Zero-Signal Grid-No.2 Current.....
- Maximum-Signal Grid-No.2 Current.....
- Effective Load Resistance (Plate-to-plate).....
- Total Harmonic Distortion.....
- Maximum-Signal Power Output.....

110
110
-8
14.4
82
88
7.2
12.5
4500
2.6
2.9
volts
volts
volts
volts
ma
ma
ma
ma
ohms
per cent
watts

Maximum Circuit Values:

- Grid-No.1 Circuit Resistance:
For fixed-bias operation.....
- For cathode-bias operation.....

0.1 *max*
0.5 *max*
megohm
megohm

■ The dc component must not exceed 100 volts.

AVERAGE CHARACTERISTICS

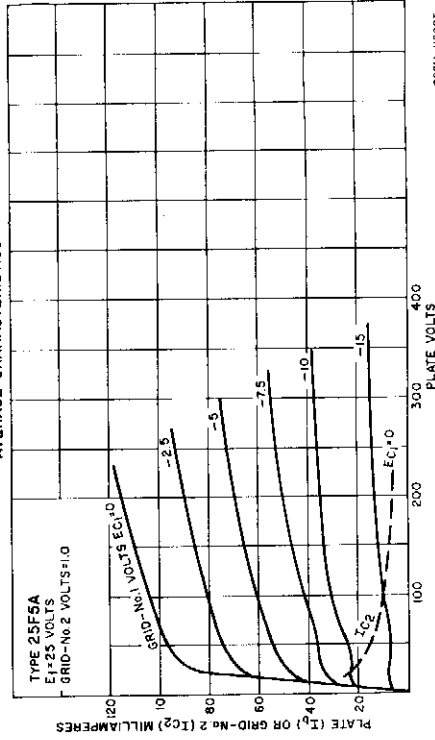

92CA-1682T

BEAM POWER TUBE

Metal type 25L6 and glass octal type 25L6-GT used in output stage of ac/dc receivers. Outlines 5 and 14C, respectively, OUTLINES SECTION. These tubes require octal sockets and may be mounted in any position. Type 25L6-GT may be supplied with pin No.1 omitted. Heater volts (ac/dc), 25; amperes, 0.3. For maximum ratings and typical operation, refer to type 50L6-GT. Refer to miniature type 50C5 for curves, installation, and application information, but take into consideration the differences in heater ratings. Type 25L6 is used principally for renewal purposes.

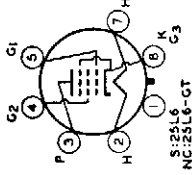

25L6
25L6GT
Related types:
12L6GT, 50L6GT

DIRECT-COUPLED TWIN POWER AMPLIFIER

Glass octal type used as class A₁ power amplifier. Heater volts (ac/dc), 25; amperes, 0.3. Characteristics as class A₁ amplifier—input triode: plate volts, 100 (180 *max*); grid volts, 0; peak at grid volts, 29.7; plate ma., 5.8. Output triode: plate volts, 180 *max*; plate ma., 46; load resistance, 4000 ohms; output watts, 3.8. This is a DISCONTINUED type listed for reference only.

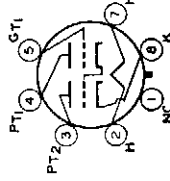

HALF-WAVE VACUUM RECTIFIER

Glass octal type used as damper tube in magnetic-deflection circuits of television receivers. Outline 14C, OUTLINES SECTION. This type may be supplied with pin No.1 omitted. Tube requires octal socket and may be mounted in any position. It is especially important that this tube, like other power-handling tubes, be adequately ventilated. Heater volts (ac/dc) 25; amperes, 0.3. This type is used principally for renewal purposes.

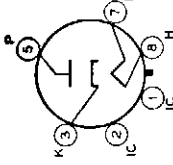

DAMPER SERVICE

Maximum Ratings, (Design-Center Values):
For operation in a 525-line, 30-frame system

PEAK INVERSE PLATE VOLTAGE† (Absolute Maximum).....	3850 <i>max</i>	volts
PEAK PLATE CURRENT.....	750 <i>max</i>	ma
DC PLATE CURRENT.....	125 <i>max</i>	ma
PLATE DISSIPATION.....	3.5 <i>max</i>	watts
PEAK HEATER-CATHODE VOLTAGE: Heater negative with respect to cathode.....	500 <i>max</i>	volts
Heater positive with respect to cathode.....	200 <i>max</i>	volts

* The duration of the voltage pulse must not exceed 15 per cent of one horizontal scanning cycle. In a 525-line, 30-frame system, 15 per cent of one horizontal scanning cycle is 10 microseconds.
† Under no circumstances should this absolute maximum value be exceeded.
‡ The dc component must not exceed 100 volts.

VACUUM RECTIFIER-DOUBLER

Glass type used as half-wave rectifier or voltage doubler in ac/dc receivers. Maximum dimensions: over-all length, 4-3/16 inches; seated height, 3-9/16 inches; diameter, 1-9/16 inches. Heater volts (ac/dc), 25; amperes, 0.3. Maximum ratings: peak inverse plate volts, 700; peak plate ma. per plate, 450; peak heater-cathode volts, 350; dc output ma. per plate, 75. This is a DISCONTINUED type listed for reference only.

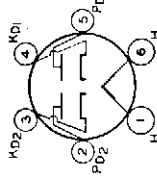

25Y5

VACUUM RECTIFIER-DOUBLER

Glass type used as half-wave rectifier or voltage doubler in ac/dc receivers. Maximum dimensions: over-all length, 4-3/16 inches; seated height, 3-9/16 inches; diameter, 1-9/16 inches. Tube requires six-contact socket and may be mounted in any position. Heater volts (ac/dc), 25; amperes, 0.3. This type is electrically identical with metal type 25Z6. Type 25Z5 is used principally for renewal purposes.

25Z5

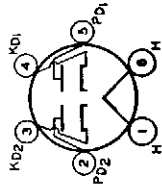

VACUUM RECTIFIER-DOUBLER

Metal type 25Z6 and glass octal type 25Z6-GT used as half-wave rectifiers or voltage doublers in ac/dc receivers, particularly "transformerless" receivers. Outlines 5 and 14C, respectively, OUTLINES SECTION. Type 25Z6-GT may be supplied with pin No.1 omitted. Tubes require octal socket. Heater volts (ac/dc), 25; amperes, 0.3. Maximum ratings for half-wave rectifier or voltage-doubler service: peak inverse plate volts, 700 *max*; peak plate ma. (per plate), 450 *max*; dc output ma. (per plate), 75 *max*; peak heater-cathode volts, 350 *max*. Typical operation as half-wave rectifier with filter-input capacitor of 16 μ f: ac plate-supply volts per plate (rms), 235; minimum total effective plate-supply impedance per plate, 1,000 ohms; dc output ma. per plate, 75; dc output volts at input to filter, 255 (at half-load current of 75 ma.), 200 (at full-load current of 150 ma.); voltage regulation, 55 volts. Typical operation as voltage doubler: ac plate-supply volts per plate (rms), 117; filter-input capacitor, 16 μ f; minimum total effective plate-supply impedance per plate, 30 ohms (half-wave), 15 ohms (full-wave); dc output ma., 75. Type 25Z6 is a DISCONTINUED type listed for reference only. Type 25Z6-GT is used principally for renewal purposes.

25Z6
25Z6GT

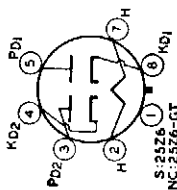

MEDIUM-MU TRIODE

Glass type used as rf voltage amplifier in ac-operated receivers. Outline 27, OUTLINES SECTION. Tube requires four-contact socket. Filament volts (ac/dc), 1.5; amperes, 1.05. Typical operation as class A₁ amplifier: plate volts, 180 *max*; grid volts, -14.5, plate ma., 6.2; plate resistance, 7300 ohms; transconductance, 1150 μ hos; amplification factor, 8.3. This is a DISCONTINUED type listed for reference only.

26

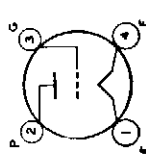

LOW-MU TRIODE

Glass type used as voltage amplifier or detector in ac-operated receivers. Tube requires five-contact socket. Heater volts (ac/dc), 2.5; amperes, 1.75. Maximum ratings and characteristics as class A₁ amplifier: plate volts, 280 *max*; grid volts, -21; amplification factor, 9; plate resistance, 9250 ohms; transconductance, 975 μ hos; plate ma., 5.2. This type is used principally for renewal purposes.

27

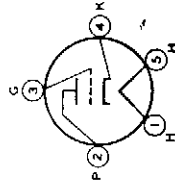

MEDIUM-MU TRIODE

Glass type used as voltage amplifier or detector in battery-operated receivers. Tube requires four-contact socket. Filament volts (dc), 2.0; amperes, 0.06. Except for interelectrode capacitances, this type is electrically identical with glass-octal type 1H4-C. Type 30 is a DISCONTINUED type listed for reference only.

30

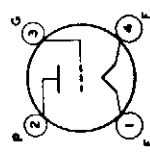

POWER TRIODE

Glass type used in output stage of battery-operated receivers. Tube requires four-contact socket. Filament volts (dc), 2.0; amperes, 0.13. Typical operation as class A₁ amplifier: plate volts, 180 *max*; grid volts, -30; plate ma., 12.3; plate resistance, 3600 ohms; amplification factor, 3.8; transconductance, 1050 μ hos; load resistance, 5700 ohms; output watts, 0.375. This is a DISCONTINUED type listed for reference only.

31

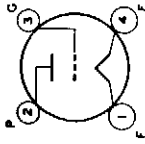

SHARP-CUTOFF TETRODE

Glass type used as rf amplifier or biased detector in battery-operated receivers. Maximum over-all length, 5-1/82 inches; maximum diameter, 1-13/16 inches. Tube requires four-contact socket. Filament volts (dc), 2.0; amperes, 0.06. Typical operation as class A₁ amplifier: plate volts, 180 *max*; grid-No.2 ma., 0.4 *max*; plate resistance, greater than 1 megohm; plate ma., 1.7; transconductance, 650 μ hos. This is a DISCONTINUED type listed for reference only.

32

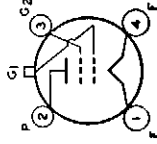

POWER PENTODE

Miniature type used in audio output stage of compact ac/dc radio receivers. Outline 7C, OUTLINES SECTION. Tube requires miniature seven-contact socket and may be mounted in any position. Heater volts (ac/dc), 32; amperes, 0.1; warm-up time (average) for type 32ET5A, 20 seconds.

32ET5
32ET5A

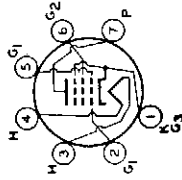

CLASS A₁ AMPLIFIER

(Maximum Ratings, (Design-Maximum Values):)

PLATE VOLTAGE.....	150 <i>max</i>	volts
GRID-NO.2 (SCREEN-GRID) VOLTAGE.....	130 <i>max</i>	volts
GRID-NO.2 INPUT.....	1.2 <i>max</i>	watts
PLATE DISSIPATION.....	5.4 <i>max</i>	watts
PEAK HEATER-CATHODE VOLTAGE.....	200 <i>max</i>	volts
Heater negative with respect to cathode.....	200 <i>max</i>	volts

Typical Operation and Characteristics:

Plate Voltage.....	110	volts
Grid-No.2 Voltage.....	110	volts
Grid-No.1 (Control-Grid) Voltage.....	-7.5	volts
Peak AF Grid-No.1 Voltage.....	7.5	volts
Zero-Signal Plate Current.....	3.0	ma
Zero-Signal Grid-No.2 Current.....	2.8	ma
Plate Resistance (Approx.).....	21500	ohms
Transconductance.....	5500	μ hos
Load Resistance.....	2800	ohms
Total Harmonic Distortion.....	10	per cent
Maximum-Signal Power Output.....	1.2	watts

Maximum Circuit Values:
Grid-No.1-Circuit Resistance:
For fixed-bias operation.....

For cathode-bias operation.....

■ The dc component must not exceed 100 volts.

0.1 *max* *megohm*
0.5 *max* *megohm*

RECTIFIER—BEAM POWER TUBE

Glass octal type used as combined half-wave rectifier and output amplifier in ac/dc receivers. Outline 15A, OUTLINES SECTION. Tube requires octal socket. Heater volts (ac/dc), 32.5; amperes, 0.3. Maximum ratings for rectifier unit: ac plate volts (rms), 125; dc output ma., 60. Typical operation of beam power unit as class A₁ amplifier: plate and grid-No.2 volts, 90; grid-No.2 ma., 27; grid-No.2 ma., 2; plate resistance, 17000 ohms; transconductance, 4800 μ mhos; load resistance, 2500 ohms; maximum-signal output watts, 1.0. This is a DISCONTINUED type listed for reference only.

32L7GT

Typical Operation and Characteristics:

Plate Voltage.....	110	volts
Grid-No.2 Voltage.....	110	volts
Grid-No.1 Voltage.....	-7.5	volts
Peak AF Grid-No.1 Voltage.....	7.5	volts
Zero-Signal Plate Current.....	35	ma
Zero-Signal Grid-No.2 Current.....	3	ma
Plate Resistance (Approx.).....	13000	ohms
Transconductance.....	5700	μ mhos
Load Resistance.....	2500	ohms
Total Harmonic Distortion.....	10	per cent
Maximum-Signal Power Output.....	1.4	watts

POWER PENTODE

Glass type used in output stage of battery-operated receivers. Outline 26, OUTLINES SECTION. Tube requires five-contact socket. Filament volts (dc), 2.0; amperes, 0.26. Typical operation as class A₁ amplifier: plate and grid-No.2 volts, 180 ma; grid-No.1 volts, -18; plate ma., 22; grid-No.2 ma., 5; plate resistance, 55000 ohms; transconductance, 1750 μ mhos; load resistance, 6000 ohms; output watts, 1.4. This is a DISCONTINUED type listed for reference only.

33

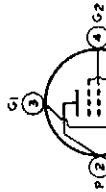

REMOTE-CUTOFF PENTODE

Glass type used as rf or if amplifier in battery-operated radio receivers, particularly those employing avc. Maximum over-all length, 5-1/32 inches; maximum diameter, 1-13/16 inches. Tube requires four-contact socket. Filament volts (dc), 2.0; amperes, 0.06. Characteristics as class A₁ amplifier: plate volts, 180 ma; grid-No.2 volts, 67.5 ma; grid-No.1 volts, -3 ma; plate ma., 2.8; grid-No.2 ma., 1.0; plate resistance, 1.0 megohm; transconductance, 620 μ mhos. This is a DISCONTINUED type listed for reference only.

34

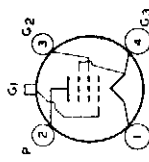

BEAM POWER TUBE

Miniature types used in audio output stages of compact ac/dc radio receivers. Outline 7C, OUTLINES SECTION. Tubes require miniature seven-contact socket and may be operated in any position.

34GD5
34GD5A

HEATER VOLTAGE (AC/DC).....	34	volts
HEATER CURRENT.....	0.1	ampere
HEATER WARM-UP TIME (AVERAGE) FOR 34GD5-A.....	20	seconds
DIRECT INTERELECTRODE CAPACITANCES (Approx.):		
Grid No.1 to Plate.....	0.6	pf
Grid No.1 to Cathode, Heater, Grid No.2, and Grid No.3.....	12	pf
Plate to Cathode, Heater, Grid No.2, and Grid No.3:		
For 34GD5.....	6	pf
For 34GD5-A.....	9	pf

CLASS A₁ AMPLIFIER

Maximum Ratings, (Design-Maximum Values):

PLATE VOLTAGE.....	150 maaz	volts
GRID-No.2 (SCREEN-GRID) VOLTAGE.....	130 maaz	volts
GRID-No.1 (CONTROL-GRID) VOLTAGE.....	50 maaz	volts
Positive-bias value.....	0 maaz	volts
Negative-bias value.....	1.1 maaz	watts
PLATE DISSIPATION.....	5 maaz	watts
PEAK HEATER-CATHODE VOLTAGE:		
Heater negative with respect to cathode.....	200 maaz	volts
Heater positive with respect to cathode.....	200 maaz	volts
BULB TEMPERATURE (At hottest point):		
For 34GD5.....	180 maaz	$^{\circ}$ C
For 34GD5-A.....	250 maaz	$^{\circ}$ C

AVERAGE CHARACTERISTICS

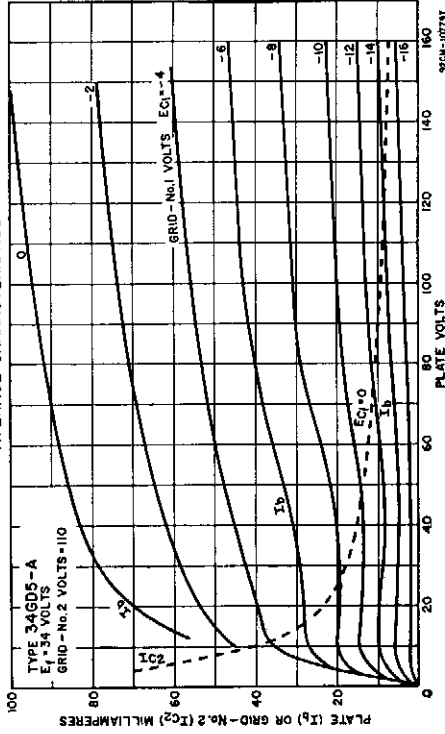

Maximum Circuit Values:
Grid-No.1-Circuit Resistance..... 0.1 maaz megohm
For fixed-bias operation..... 0.5 maaz megohm
For cathode-bias operation.....
The dc component must not exceed 100 volts.

REMOTE-CUTOFF TETRODE

Glass type used as rf or if amplifier in ac receivers. Maximum over-all length, 5-1/32 inches; maximum diameter, 1-13/16 inches. Tube requires five-contact socket. Heater volts (ac/dc), 2.5; amperes, 1.75. Characteristics as class A₁ amplifier: plate volts, 250 (375 maaz); grid-No.2 volts, 90 ma; grid-No.1 volts, -3 ma; plate ma., 6.5; grid-No.2 ma., 2.5; transconductance, 1050 μ mhos. This is a DISCONTINUED type listed for reference only.

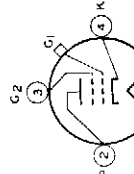

35

BEAM POWER TUBE

Glass lock-in type used in output stage of ac/dc receivers. Outline 13B, OUTLINES SECTION. Tube requires lock-in socket. Heater volts (ac/dc), 35; amperes, 0.15. For maximum ratings and typical operation, refer to glass octal type 35L6-GT. Type 35A5 is used principally for renewal purposes.

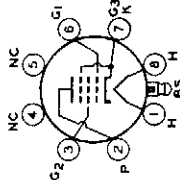

35A5

BEAM POWER TUBE

Miniature type used in output stage of compact, ac/dc radio receivers. Because of its high power sensitivity at plate and screen-grid voltages available in ac/dc receivers, it is capable of providing a relatively high power output. Outline 7C, OUTLINES SECTION. Tube requires miniature seven-contact socket and may be mounted in any position. Within its maximum ratings, type 35B5 is equivalent in performance to glass-octal type 35L6-GT, and miniature type 35C5. Refer to type 35C5 for typical operation, maximum circuit values, installation, application information, and curves.

35B5

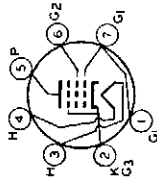

HEATER VOLTAGE (AC/DC)	35 volts
HEATER CURRENT	0.15 ampere
DIRECT INTERELECTRODE CAPACITANCES (Approx.):	
Grid No.1 to Plate	0.6 pf
Grid No.1 to Cathode, Heater, Grid No.2, and Grid No.3	12 pf
Plate to Cathode, Heater, Grid No.2, and Grid No.3	9 pf

CLASS A₁ AMPLIFIER

Maximum Ratings, (Design-Center Values):

PLATE VOLTAGE	117 maz
GRID-NO.2 (SCREEN-GRID) VOLTAGE	4.5 maz
PLATE DISSIPATION	1.0 maz
GRID-NO.2 INPUT	150 maz
PEAK HEATER-CATHODE VOLTAGE:	
Heater negative with respect to cathode	150 maz
Heater positive with respect to cathode	150 maz

BEAM POWER TUBE

Miniature type used in output stage of compact, ac/dc radio receivers. Because of its high power sensitivity and high efficiency at plate and screen-grid voltages available in ac/dc receivers, the 35C5 is capable of providing a relatively high power output. Except for terminal connections and slightly higher ratings, type 35C5 is equivalent in performance to miniature type 35B5 and, within its maximum ratings, to glass octal type 35L6-GT. The basing arrangement of the 35C5 simplifies the problem of meeting Underwriters' Laboratories requirements in the design of ac/dc receivers.

35C5

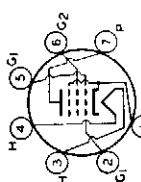

HEATER VOLTAGE (AC/DC)	35 volts
HEATER CURRENT	0.15 ampere
DIRECT INTERELECTRODE CAPACITANCES (Approx.):	
Grid No.1 to Plate	0.6 pf
Grid No.1 to Cathode, Heater, Grid No.2, and Grid No.3	12 pf
Plate to Cathode, Heater, Grid No.2, and Grid No.3	9 pf

CLASS A₁ AMPLIFIER

Maximum Ratings, (Design-Maximum Values):

PLATE VOLTAGE	150 maz
GRID-NO.2 (SCREEN-GRID) VOLTAGE	130 maz
PLATE DISSIPATION	5.2 maz
GRID-NO.2 INPUT	1.1 maz
PEAK HEATER-CATHODE VOLTAGE:	
Heater negative with respect to cathode	200 maz
Heater positive with respect to cathode	200 ^m maz
BULB TEMPERATURE (At hottest point)	250 maz °C

Typical Operation:

Plate Voltage	110 volts
Grid-No.2 Voltage	110 volts
Grid-No.1 (Control-Grid) Voltage	7.5 volts
Peak AF Grid-No.1 Voltage	40 ma
Zero-Signal Plate Current	4.1 ma
Maximum-Signal Plate Current	3 ma
Zero-Signal Grid-No.2 Current	7 ma
Maximum-Signal Grid-No.2 Current	7 ma

Plate Resistance (Approx.)	13000 ohms
Transconductance	5800 μmhos
Load Resistance	2500 ohms
Total Harmonic Distortion	10 per cent
Maximum-Signal Power Output	1.5 watts

Maximum Circuit Values:

Grid-No.1-Circuit Resistance:	0.1 maz
For fixed-bias operation	0.5 maz
For cathode-bias operation	megohm
For cathode-bias operation	megohm

The dc component must not exceed 100 volts.

AVERAGE PLATE CHARACTERISTICS
PENTODE CONNECTION

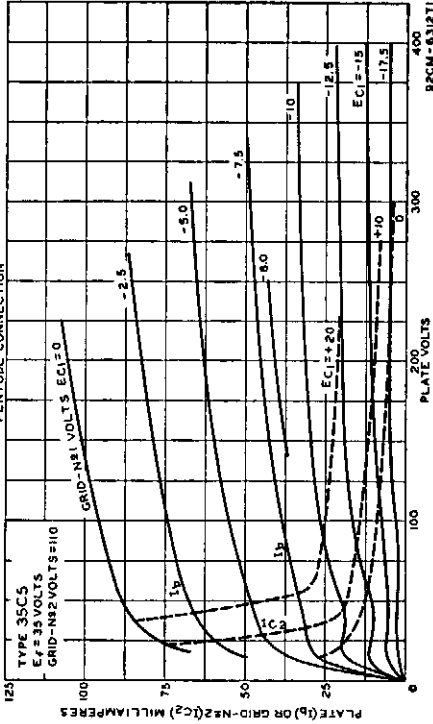

INSTALLATION AND APPLICATION

Type 35C5 requires miniature seven-contact socket and may be mounted in any position. Outline 7C, OUTLINES SECTION. It is especially important that this tube, like other power-handling tubes, should be adequately ventilated.

The 35-volt heater is designed to operate under the normal conditions of line-voltage variation without materially affecting the performance or serviceability of the 35C5. For operation of the 35C5 in series with other types having 0.15-ampere rating, the current in the heater circuit should be adjusted to 0.15 ampere for the normal supply voltage.

**HIGH-MU TRIODE
POWER PENTODE**

Miniature type used as two-stage amplifier where plate supply voltage is obtained from single half-wave rectifier connected directly to 120-volt ac line. Outline 8E, OUTLINES SECTION.

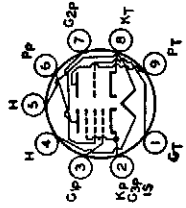

Tube requires maximum vertical dimensions are 1/16 inch greater than shown. Heater volts (ac/dc), 35; amperes, 0.15.

35DZ8

CLASS A₁ AMPLIFIER

Maximum Ratings:

PLATE VOLTAGE	150 maz	Triode Unit	150 maz	Pentode Unit	150 maz
GRID-NO.2 (SCREEN-GRID) VOLTAGE	135 maz		135 maz		135 maz
CATHODE CURRENT	5 maz		5 maz		5 maz
PLATE DISSIPATION	6.5 maz		6.5 maz		6.5 maz
GRID-NO.2 INPUT	1.5 maz		1.5 maz		1.5 maz

PEAK HEATER-CATHODE VOLTAGE:
 Heater negative with respect to cathode.
 Heater positive with respect to cathode.

Triode Unit	Pentode Unit
200 max	200 max
200 max	200 max

Typical Operation and Characteristics:

Plate Supply Voltage	120 volts
Grid-No.2 Supply Voltage	145 volts
Cathode-Bias Resistor	120 ohms
Amplification Factor	1500
Plate Current	100 ma
Grid-No.2 Current	0.8 ma
Transconductance	1400 μ hos
Load Resistance	7500 ohms
Power Output	2500 watts
Grid Voltage (Approx.), for plate current of 20 μ a	2 - volts

Maximum Circuit Values:

Grid-No.1-Circuit Resistance	5 max megohms
The dc component must not exceed 100 volts.	0.5 max megohms

POWER PENTODE

Miniature type used in the audio output stage of radio and television receivers and in phonographs. This type has unusually high power sensitivity and is capable of providing relatively high power output at low plate and screen-grid voltages with a low af grid-No.1 driving voltage. Outline 7C, OUTLINES SECTION. Tube requires miniature seven-contact socket and may be mounted in any position.

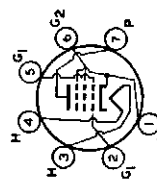

35EH5

Miniature type used in the audio output stage of radio and television receivers and in phonographs. This type has unusually high power sensitivity and is capable of providing relatively high power output at low plate and screen-grid voltages with a low af grid-No.1 driving voltage. Outline 7C, OUTLINES SECTION. Tube requires miniature seven-contact socket and may be mounted in any position.

HEATER VOLTAGE (AC/DC): 35 volts
HEATER CURRENT: 0.15 amperes

DIRECT INTERELECTRODE CAPACITANCES (Approx.):

Grid No.1 to Plate	0.65 pf
Grid No.1 to Cathode, Heater, Grid No.2, and Grid No.3	17 pf
Plate to Cathode, Heater, Grid No.2, and Grid No.3	9 pf

CLASS A₁ AMPLIFIER

Maximum Ratings, (Design-Maximum Values):

PLATE VOLTAGE	150 max volts
GRID-NO.2 (SCREEN-GRID) VOLTAGE	130 max volts
GRID-NO.1 (CONTROL-GRID) VOLTAGE, Positive-bias value	0 max volts
PLATE DISSIPATION	5 max watts
GRID-NO.2 ISPUT	1.75 max watts

PEAK HEATER-CATHODE VOLTAGE:
 Heater negative with respect to cathode.
 Heater positive with respect to cathode.

BULB TEMPERATURE (At hottest point)	200 max volts
	200 max volts
	225 max $^{\circ}$ C

Typical Operation:

Plate Supply Voltage	110 volts
Grid-No.2 Supply Voltage	115 volts
Cathode-Bias Resistor	62 ohms
Peak AF Grid-No.1 Voltage	3 volts
Zero-Signal Plate Current	32 ma
Maximum-Signal Plate Current	32 ma
Zero-Signal Grid-No.2 Current	7.2 ma
Maximum-Signal Grid-No.2 Current	12 ma
Plate Resistance (Approx.)	14000 ohms
Transconductance	3000 μ hos
Load Resistance	3000 ohms
Total Harmonic Distortion	8 per cent
Maximum-Signal Power Output	1.2 watts

Maximum Circuit Values:

Grid-No.1-Circuit Resistance	0.1 max megohm
For fixed-bias operation	0.5 max megohm
For cathode-bias operation	
The dc component must not exceed 100 volts.	

In a series-heater circuit of the "dc power line" type employing several 0.15-ampere types and one or two 35C5s, the heater(s) of the 35C5(s) should be placed on the positive side of the line. Under these conditions, heater-cathode voltage of the 35C5 must not exceed the value given under maximum ratings. In a series-heater circuit of the "universal" type employing rectifier tube 35W4, one or two 35C5s and several 0.15-ampere types, it is recommended that the heater(s) of the 35C5(s) be placed in the circuit so that the higher values of heater-cathode bias will be impressed on the 35C5(s) rather than on the other 0.15-ampere types. This is accomplished by arranging the 35C5(s) on the side of the supply line which is connected to the cathode of the rectifier, i.e., the positive terminal of the rectified voltage supply. Between this side of the line and the 35C5(s), any necessary auxiliary resistance and the heater of the 35W4 are connected in series.

As a power amplifier (class A₁), the 35C5 is recommended for use either singly or in push-pull combination in the power-output stage of ac/dc receivers. The operating values shown under typical operation have been determined on the basis that grid-No.1 current does not flow during any part of the input cycle.

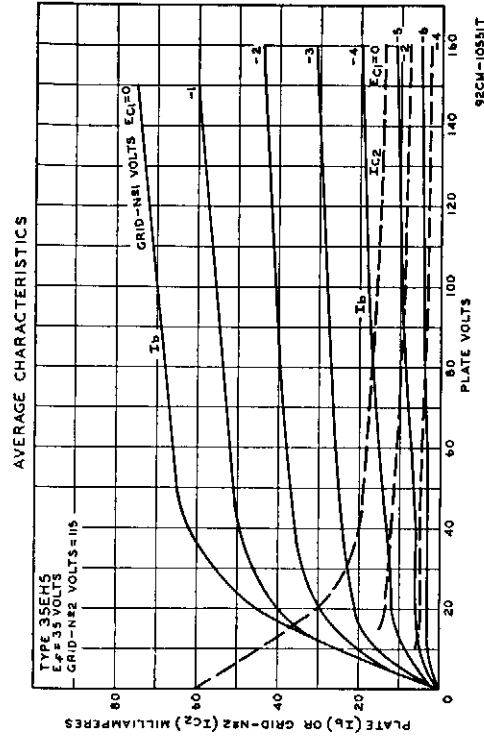

BEAM POWER TUBE

Miniature type used in af power-output stage of radio receivers. Outline 7C, OUTLINES SECTION. Tube has heater tap which may be used for operating a 6.3-volt, 150-ma. panel lamp in equipment using semiconductor rectifiers. For dc output currents greater than 70 ma., a resistor shunting the panel lamp is required. Tube requires miniature seven-contact socket and may be operated in any position.

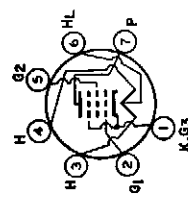

35GL6

HEATER VOLTAGE (AC/DC):

ENTIRE HEATER (PINS 3 AND 4)	35 volts
PANEL LAMP SECTION (PINS 4 AND 6)	7 volts
HEATER CURRENT:	
BETWEEN PINS 3 AND 4	0.15 ampere
BETWEEN PINS 3 AND 6	0.15 ampere

With No.40 Panel or 17 Panel Lamp

35	32 volts
7	5.5 volts
0.15	0.15 ampere
0.15	0.15 ampere

CLASS A₁ AMPLIFIER

Maximum Ratings, (Design-Maximum Values):

RMS HEATER-TAP VOLTAGE, when panel lamp fails.....	14 maz	volts
PLATE VOLTAGE.....	160 maz	volts
GRID-NO.2 (SCREEN-GRID) VOLTAGE.....	130 maz	volts
PLATE DISSIPATION.....	5.5 maz	watts
GRID-NO.2 INPUT.....	1.1 maz	watts
PEAK HEATER-CATHODE VOLTAGE: Heater negative with respect to cathode.....	200 maz	volts
Heater positive with respect to cathode.....	200 maz	volts
BULB TEMPERATURE (At hottest point).....	225 maz	°C

Typical Operation and Characteristics:

Plate Voltage.....	110	volts
Grid-No.2 Voltage.....	110	volts
Grid-No.1 (Control-Grid) Voltage.....	-7.5	volts
Peak A-F Grid-No.1 Voltage.....	7.5	volts
Zero-Signal Plate Current.....	45	ma
Maximum-Signal Plate Current.....	47	ma
Zero-Signal Grid-No.2 Current.....	9	ma
Maximum-Signal Grid-No.2 Current.....	9	ma
Plate Resistance (Approx.).....	12000	ohms
Transconductance.....	7300	μmhos
Load Resistance.....	2500	ohms
Total Harmonic Distortion.....	8	per cent
Maximum-Signal Power Output.....	1.8	watts

Maximum Circuit Values:

Grid-No.1-Circuit Resistance: For fixed-bias operation.....	0.1 maz	megohm
For cathode-bias operation.....	0.5 maz	megohm

BEAM POWER TUBE

Glass octal type used in output stage of ac/dc radio receivers. Outline line 14C, OUTLINES SECTION. Tube requires octal socket and may be mounted in any position. This type may be supplied with pin No.1 omitted. Refer to miniature type 35C5 for installation, application information, and curves.

35L6GT

HEATER VOLTAGE (AC/DC).....	35	volts
HEATER CURRENT.....	0.15	ampere
DIRECT INTERELECTRODE CAPACITANCES (Approx.):		
Grid No.1 to Plate.....	0.6	pf
Grid No.1 to Cathode, Heater, Grid No.2, and Grid No.3.....	18	pf
Plate to Cathode, Heater, Grid No.2, and Grid No.3.....	9.5	pf

CLASS A₁ AMPLIFIER

Maximum Ratings, (Design-Center Values):

PLATE VOLTAGE.....	200 maz	volts
GRID-NO.2 (SCREEN-GRID) VOLTAGE.....	125 maz	volts
PLATE DISSIPATION.....	3.5 maz	watts
GRID-NO.2 INPUT.....	1.0 maz	watts
PEAK HEATER-CATHODE VOLTAGE: Heater negative with respect to cathode.....	90 maz	volts
Heater positive with respect to cathode.....	90 maz	volts

Typical Operation:

Plate Supply Voltage.....	110	volts
Grid-No.2 Supply Voltage.....	110	volts
Grid-No.1 (Control-Grid) Voltage.....	-7.5	volts
Cathode-Bias Resistor.....	180	ohms
Peak A-F Grid-No.1 Voltage.....	7.5	volts
Zero-Signal Plate Current.....	40	ma
Maximum-Signal Plate Current.....	43	ma
Zero-Signal Grid-No.2 Current.....	2	ma
Maximum-Signal Grid-No.2 Current.....	2	ma
Plate Resistance (Approx.).....	14000	ohms
Transconductance.....	5800	μmhos
Load Resistance.....	2500	ohms
Total Harmonic Distortion.....	10	per cent
Maximum-Signal Power Output.....	1.5	watts

Maximum Circuit Values:

Grid-No.1-Circuit Resistance: For fixed-bias operation.....	0.1 maz	megohm
For cathode-bias operation.....	0.5 maz	megohm

HALF-WAVE VACUUM RECTIFIER

Miniature type used in power supply of ac/dc receivers. Equivalent in performance to glass-octal type 35Z5-GT. The heater is provided with a tap for operation of a panel lamp.

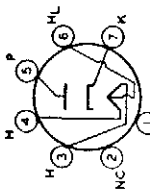

35W4

HEATER VOLTAGE (AC/DC): ENTIRE HEATER (PINS 3 AND 4).....	35	volts
PANEL LAMP SECTION (PINS 4 AND 6).....	7.5	volts
HEATER CURRENT: BETWEEN PINS 3 AND 4.....	0.15	ampere
BETWEEN PINS 3 AND 6.....	—	ampere

* Without panel lamp. ** With No.40 or No.47 panel lamp.

HALF-WAVE RECTIFIER

Maximum Ratings, (Design-Maximum Values):

PEAK INVERSE PLATE VOLTAGE.....	360 maz	volts
PEAK PLATE CURRENT.....	660 maz	ma
DC OUTPUT CURRENT: Without Panel Lamp.....	68 maz	ma
With Panel Lamp and { No Shunting Resistor.....	100 maz	ma
{ Shunting Resistor.....	110 maz	ma
PANEL-LAMP-SECTION VOLTAGE (rms): When Panel Lamp Fails.....	17 maz	volts
PEAK HEATER-CATHODE VOLTAGE: Heater negative with respect to cathode.....	360 maz	volts
Heater positive with respect to cathode.....	360 maz	volts

INSTALLATION AND APPLICATION

Tube requires miniature seven-contact socket and may be mounted in any position. Outline 7C, OUTLINES SECTION. For heater considerations, refer to miniature type 35C5.

With the panel lamp connected as shown in the diagram, the drop across R and all heaters (with panel lamp) should equal 117 volts at 0.15 ampere. The shunting resistor R_{sh} is required when dc output current exceeds 60 milliamperes. Values of R_{sh} for dc output currents greater than 60 milliamperes are given in tabulated data.

OPERATION CHARACTERISTICS

TYPE 35W4
HALF-WAVE RECTIFIER

E_p = 35 VOLTS BETWEEN PINS N₁3 & N₁4 (NO TAP CONNECTION)

PLATE VOLTS = 117 RMS

TOTAL EFFECTIVE PLATE-SUPPLY RESISTANCE

C-CAPACITOR INPUT TO FILTER

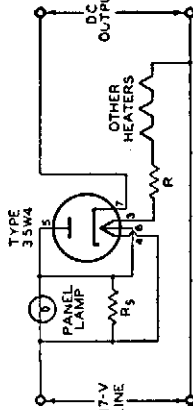
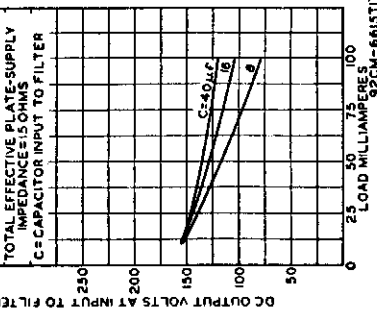

Typical Operation with Panel Lamp†

AC Plate-Supply Voltage (rms).....	117	117	117	117	volts
Filter-Input Capacitor.....	40	40	40	40	μf
Minimum Total Effective Plate-Supply Impedance.....	15	15	15	15	ohms
Panel-Lamp Shunting Resistor.....	300	150	100	100	ohms
DC Output Current.....	60	70	80	90	ma

† No.40 or No.47 panel lamp used in circuit given below with capacitor-input filter.

Typical Operation without Panel Lamp:

AC Plate-Supply Voltage (rms).....	117	volts
Filter-Input Capacitor.....	40	μf
Minimum Total Effective Plate-Supply Impedance.....	15	ohms
DC Output Current.....	100	ma

DC Output Voltage at Input to Filter (Approx.):

At full-load current (50 ma.)	135	volts
At half-load current (100 ma.)	120	volts

Voltage Regulation (Approx.):

Half-load to full-load current	15	volts
--------------------------------	----	-------

Maximum Circuit Values:

Panel-Lamp Shunting Resistor:*

At half-load current of 70 ma.	800 maz	ohms
(90 ma.)	400 maz	ohms
	250 maz	ohms

* Required when dc output current is greater than 60 milliamperes.

HALF-WAVE VACUUM RECTIFIER

Glass lock-in type used in power supply of ac/dc receivers. The heater is provided with tap for the operation of a panel lamp. Outline 13B, OUTLINES SECTION. Tube requires lock-in socket. Heater volts (ac/dc), 35; amperes, 0.15. For maximum ratings, refer to glass octal type 35Z5-GT. For typical operation and curves, refer to miniature type 35W4. Type 35Y4 is used principally for renewal purposes.

35Y4



HALF-WAVE VACUUM RECTIFIER

Glass lock-in type used in power supply of ac/dc receivers. Outline 13B, OUTLINES SECTION. Tube requires lock-in socket. Heater volts (ac/dc), 35; amperes, 0.15. For maximum ratings and typical operation, refer to glass octal type 35Z5-GT without panel lamp. Type 35Z3 is used principally for renewal purposes.

35Z3



HALF-WAVE VACUUM RECTIFIER

Glass octal type used in power supply of ac/dc receivers. Outline 14C, OUTLINES SECTION. Tube requires octal socket. This type may be supplied with pin No.1 omitted. Heater volts (ac/dc), 35; amperes, 0.15. For maximum ratings and typical operation, refer to glass octal type 35Z5-GT without panel lamp. Type 35Z4-GT is used principally for renewal purposes.

35Z4GT



HALF-WAVE VACUUM RECTIFIER

Glass octal type used in power supply of ac/dc receivers. The heater is provided with a tap for operation of a panel lamp. Outline 14C, OUTLINES SECTION. Tube requires octal socket and may be mounted in any position. This type may be supplied with pin No.1 omitted. For installation and application considerations, refer to miniature type 35W4.

35Z5GT



HEATER VOLTAGE (AC/DC):

ENTIRE HEATER (PINS 2 AND 7)	** 32	volts
PANEL LAMP SECTION (PINS 2 AND 3)	5.5	volts

HEATER CURRENT:

BETWEEN PINS 2 AND 7	0.15	ampere
BETWEEN PINS 3 AND 7	-	ampere

* Without panel lamp. ** With No. 40 or No. 47 panel lamp.

HALF-WAVE RECTIFIER

Maximum Ratings, (Design-Center Values):

PEAK INVERSE PLATE VOLTAGE	700 maz	volts
PEAK PLATE CURRENT	600 maz	ma
DC OUTPUT CURRENT	60 maz	ma
With Panel Lamp and Shunting Resistor	90 maz	ma
Without Panel Lamp	100 maz	ma

PANEL-LAMP-SECTION VOLTAGE (rms):

When Panel Lamp Pairs	15 maz	volts
PEAK HEATER-CATHODE VOLTAGE:	350 maz	volts
Heater negative with respect to cathode	350 maz	volts

Typical Operation with Panel Lamp†

AC Plate-Supply Voltage (rms)	117	117	117	235
Filter-Input Capacitor	40	40	40	40
Minimum Total Effective Plate-Supply Impedance	15	15	15	100
Panel-Lamp Shunting Resistor	-	300	150	100
DC Output Current	60	70	80	90

† No.40 or No.47 panel lamp used in circuit with capacitor-input filter given under type 35W4.

Typical Operation without Panel Lamp:

AC Plate-Supply Voltage (rms)	117
Filter-Input Capacitor	40
Minimum Total Effective Plate-Supply Impedance	15
DC Output Current	100
DC Output Voltage at Input to Filter (Approx.):	140
At half-load current (50 ma.)	120
At full-load current (100 ma.)	20
Voltage Regulation (Approx.):	45
Half-load to full-load current	45

Maximum Circuit Values:

Panel-Lamp Shunting Resistor*:

For dc output current of 70 ma	800 maz	ohms
(90 ma)	400 maz	ohms
	250 maz	ohms

* Required when dc output current is greater than 60 milliamperes.

SHARP-CUTOFF TETRODE

Glass type used as rf or if amplifier or as biased or grid-resistor detector in radio receivers. Outline 24B, OUTLINES SECTION. Tube requires five-contact socket. Heater volts (ac/dc), 6.3; amperes, 0.3. Characteristics as class A₁ amplifier: plate volts, 250 maz; grid-No.2 volts, 90 maz; grid-No.1 volts, -8; plate ma., 3.2; grid-No.2 ma., 1.7 maz; plate resistance, 0.55 megohm; transconductance, 1980 μ mhos. This is a DISCONTINUED type listed for reference only.

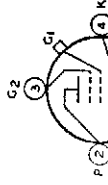

36

HALF-WAVE VACUUM RECTIFIER

Miniature types used in power supply of ac/dc receivers. These types have a tapped heater so that the heater section between pins 4 and 6 can be used as a limiting resistance in the rectifier plate circuit. This heater section is not to be used as a panel-lamp shunt. Outline 7C, OUTLINES SECTION. Tubes require miniature seven-contact socket and may be operated in any position. Type 36AM3 is a DISCONTINUED type listed for reference only.

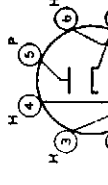

**36AM3
36AM3A
36AM3B**

HEATER VOLTAGE (AC/DC):

ENTIRE HEATER (PINS 3 AND 4)	35	volts
TAP SECTION (PINS 3 AND 6)	32	volts
HEATER CURRENT (PINS 3 AND 6)	0.1	ampere
HEATER WARM-UP TIME (AVERAGE), For 36AM3-B	20	seconds

HALF-WAVE RECTIFIER

Maximum Ratings, (Design-Maximum Values):

PEAK INVERSE PLATE VOLTAGE	36AM3-A 36AM3-B	365 maz	volts
PEAK PLATE CURRENT	365 maz	ma	
DC OUTPUT CURRENT	540 maz	ma	
With Panel Lamp and Shunting Resistor	82 maz	ma	
Without Panel Lamp	350* maz	ma	
Without Panel Lamp	200* maz	ma	

Typical Operation with Capacitor Input to Filter:

AC Plate-Supply Voltage (rms).....	120	volts
Filter-Input Capacitor.....	40	μ f
Total Effective Plate Supply Resistance.....	75	ma
DC Output Current.....	118	volts

Characteristics:

Tube Voltage Drop for plate current of 150 ma.....	16	volts
• The dc component must not exceed 350 volts.		
• The dc component must not exceed 100 volts.		

MEDIUM-MU TRIODE

Glass type used as voltage amplifier or detector in radio receivers. Tube requires five-contact socket. Heater volts (ac/dc), 6.3; amperes, 0.3. Characteristics as class A₁ amplifier: plate volts, 250 maz; grid volts, -18; plate ma., 7.5; plate resistance, 8400 ohms; amplification factor, 9.2; transconductance, 1100 μ mhos. This is a DISCONTINUED type listed for reference only.

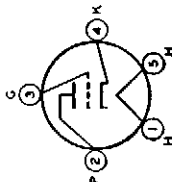

37

POWER PENTODE

Glass type used in output stage of radio receivers. Outline 24B, OUTLINES SECTION. Tube requires five-contact socket. Heater volts (ac/dc), 6.3; amperes, 0.3. Characteristics as class A₁ amplifier: plate and grid-No.2 volts, 250 maz; grid-No.1 volts, -25; plate ma., 22; grid-No.2 ma., 3.8; plate resistance, 0.1 megohm; transconductance, 1200 μ mhos; load resistance, 10000 ohms; output watts, 2.5. This is a DISCONTINUED type listed for reference only.

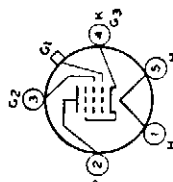

38

REMOTE-CUTOFF PENTODE

Glass type used as rf or if amplifier in radio receivers, particularly those employing vacuum tubes. Outline 24B, OUTLINES SECTION. Tube requires five-contact socket. Heater volts (ac/dc), 6.3; amperes, 0.3. Characteristics as class A₁ amplifier: plate volts, 250 maz; grid-No.2 volts, 30 maz; grid-No.1 volts, -3 μ ms; plate ma., 5.8; grid-No.2 ma., 1.4; plate resistance, 1.0 megohm; transconductance, 1050 μ mhos. This is a DISCONTINUED type listed for reference only.

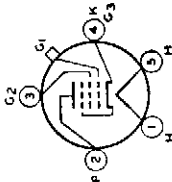

39/44

MEDIUM-MU TRIODE

Glass type used as resistance-coupled or impedance-coupled amplifier in battery-operated receivers. Outline 27, OUTLINES SECTION. Filament volts (dc), 5; amperes, 0.25. Characteristics as class A₁ amplifier: plate-supply volts, 180; load resistance, 250000 ohms; grid volts, -3; plate ma., 0.2; plate resistance, 150000 ohms; amplification factor, 39; transconductance, 200 μ mhos. This is a DISCONTINUED type listed for reference only.

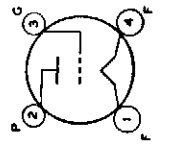

40

POWER PENTODE

Glass type used in output stage of radio receivers. Tube requires six-contact socket. Heater volts (ac/dc), 6.3; amperes, 0.4. This type is electrically identical with type 6K6-GT. Type 41 is used principally for renewal purposes.

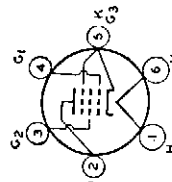

41

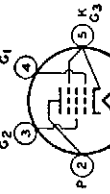

POWER PENTODE

Glass type used in audio output stage of ac receivers. Outline 27, OUTLINES SECTION. Tube requires six-contact socket. Heater volts (ac/dc), 6.3; amperes, 0.7. This type is electrically identical with type 6F6. Type 42 is used principally for renewal purposes.

42

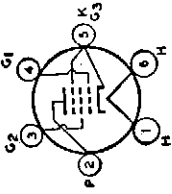

POWER PENTODE

Glass type used in audio output stage of ac/dc receivers. Outline 27, OUTLINES SECTION. Tube requires six-contact socket. Heater volts (ac/dc), 25; amperes, 0.3. This type is electrically identical with type 25A6. Type 43 is used principally for renewal purposes.

43

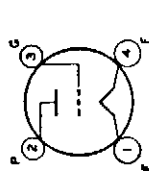

POWER TRIODE

Glass type used in output stage of radio receivers. Outline 27, OUTLINES SECTION. Tube requires four-contact socket. Filament volts (ac/dc), 2.5; amperes, 1.5. Typical operation as class A₁ amplifier: plate supply volts, 275 maz; grid volts, -56; cathode-bias resistor, 1550 ohms; amplification factor, 3.5; plate resistance, 1700 ohms; transconductance, 2050 μ mhos; plate ma., 36; load resistance, 4600 ohms; undistorted power output, 2 watts. This is a DISCONTINUED type listed for reference only.

45

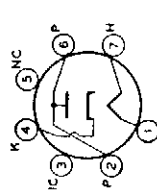

HALF-WAVE VACUUM RECTIFIER

Miniature type used in power supply of small, portable, ac/dc/battery receivers where small size and low heat dissipation are important. Outline 7B, OUTLINES SECTION. Tube requires miniature seven-contact socket and may be mounted in any position. Heater volts (ac/dc), 45; amperes, 0.075. Maximum ratings: peak inverse plate volts, 350 maz; peak plate ma., 390 maz; dc output ma., 65 maz; peak heater-cathode volts, 175 maz. Typical operation with capacitor-input filter: ac plate volts (rms), 117; minimum total effective plate-supply impedance, 15 ohms; dc output ma., 65. This is a DISCONTINUED type listed for reference only.

45Z3

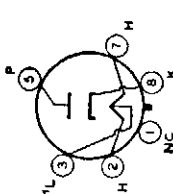

HALF-WAVE VACUUM RECTIFIER

Glass octal type used in power supply of ac/dc receivers. The heater is provided with a tap for operation of a panel lamp. Outline 14C, OUTLINES SECTION. Tube requires octal socket. Without panel lamp, heater volts (ac/dc) of entire heater (pins 2 and 7), 45; amperes, 0.16. With panel lamp, heater volts (ac/dc) of panel lamp section (pins 2 and 3 with 0.15 ampere between pins 2 and 7), 5.5. Except for difference in heater voltage, this type has the same ratings and typical operation values as glass octal type 35Z5-GT. Type 45Z5-GT is a DISCONTINUED type listed for reference only.

45Z5GT

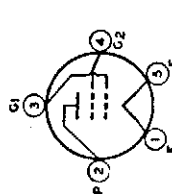

DUAL-GRID POWER AMPLIFIER

Glass type used as class A₁ or class B amplifier in radio equipment. Outline 28, OUTLINES SECTION. Tube requires five-contact socket. Filament volts (ac/dc), 2.5; amperes, 1.75. Typical operation as class A₁ amplifier (grid No.2 connected to plate at socket): plate volts, 250 maz; grid volts, -33; plate ma., 22; plate resistance, 2380 ohms; amplification factor, 5.6; transconductance, 2350 μ mhos; load resistance for maximum undistorted power output, 6400 ohms; output watts, 1.25. This is a DISCONTINUED type listed for reference only.

46

47

POWER PENTODE

Glass type used in audio output stage of radio receivers. Outline 28, OUTLINES SECTION. Tube requires five-contact socket and should preferably be mounted in vertical position. Horizontal operation is permissible if pins 1 and 5 are in vertical plane. Filament volts (ac/dc), 2.5; ampere, 1.75. Typical operation as class A₁ amplifier: plate and grid-No.2 volts, 250 maz; cathode-bias resistor, 450 ohms; plate ma., 31; grid-No.2 ma., 6; plate resistance, 60000 ohms; transconductance, 2500 μ mhos; load resistance, 7000 ohms; power output, 2.7 watts. This type is used principally for renewal purposes.

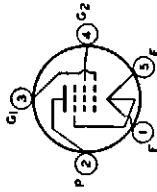

48

POWER TETRODE

Glass type used in audio output stage of radio receivers designed to operate from dc powerlines. Outline 28, OUTLINES SECTION. Heater volts (dc), 50; ampere, 0.4. Typical operation as class A₁ amplifier: plate volts, 125 maz; grid-No.2 volts, 100 maz; grid-No.1 volts, -20; plate ma., 56; grid-No.2 ma., 9.5; transconductance, 3900 μ mhos; load resistance, 1500 ohms; output watts, 2.5. This is a DISCONTINUED type listed for reference only.

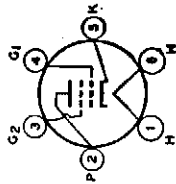

49

DUAL-GRID POWER AMPLIFIER

Glass type used in output stage of battery-operated receivers. Outline 27, OUTLINES SECTION. Tube requires five-contact socket. Filament volts (dc), 2.0; ampere, 0.12. Typical operation as class A₁ amplifier (grid No.2 connected to plate at socket): plate volts, 135 maz; grid volts, -20; plate ma., 6; plate resistance, 4175 ohms; amplification factor, 4.7; transconductance, 1125 μ mhos; load resistance, 11000 ohms; output watts (approx.), 0.17. This is a DISCONTINUED type listed for reference only.

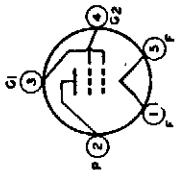

50

POWER TRIODE

Glass type used in output stage of amplifiers employing transformer input coupling. Maximum over-all length, 6-1/4 inches; maximum diameter, 2-7/16 inches. Tube requires four-contact socket and should be mounted in vertical position with base down. Filament volts (ac/dc), 7.5; ampere, 1.25. Characteristics as class A₁ amplifier: plate volts, 450 maz; plate volts, -84; cathode resistor, 1530 ohms; plate resistance, 1800 ohms; amplification factor, 3.8; transconductance, 2100 μ mhos; load resistance, 4350 ohms; output watts, 4.6. This is a DISCONTINUED type listed for reference only.

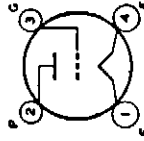

BEAM POWER TUBE

Glass lock-in type used in output stage of ac/dc receivers. Outline 13B, OUTLINES SECTION. Tube requires lock-in socket. Heater volts (ac/dc), 50; ampere, 0.15. For ratings and data, refer to type 50L6-GT. Type 50A5 is used principally for renewal purposes.

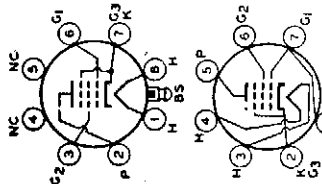

BEAM POWER TUBE

Miniature type used in output stage of compact ac/dc receivers. Because of its high power sensitivity at plate and screen-grid voltages available in ac/dc receivers, it is capable of providing a relatively high power-output. Outline 7C, OUTLINES SECTION.

50B5

Tube requires miniature seven-contact socket and may be mounted in any position. Except for basing arrangement, type 50B5 is identical with miniature type 50C5.

BEAM POWER TUBE

Miniature type used in output stage of compact, ac/dc radio receivers. Because of its high power sensitivity and high efficiency at plate and screen-grid voltages available in ac/dc receivers, the 50C5 is capable of providing a relatively high power output.

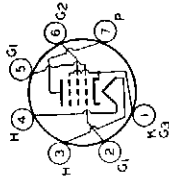

50C5
Related type:
25C5

Within its maximum ratings, type 50C5 is equivalent in performance to glass octal type 50L6-GT. The basing arrangement of the 50C5 simplifies the problem of meeting Underwriters' Laboratories requirements in the design of ac/dc receivers.

HEATER VOLTAGE (AC/DC)	50	volts
HEATER CURRENT	0.15	ampere
DIRECT INTERELECTRODE CAPACITANCES (Approx.):		
Grid No.1 to Plate	0.6	pf
Grid No.1 to Cathode, Heater, Grid No.2, and Grid No.3	13	pf
Plate to Cathode, Heater, Grid No.2, and Grid No.3	8.5	pf

CLASS A₁ AMPLIFIER

Maximum Ratings, (Design-Maximum Values):

PLATE VOLTAGE	150 maz	volts
GRID-No.2 (SCREEN-GRID) VOLTAGE	130 maz	volts
GRID-No.1 (CONTROL-GRID) VOLTAGE	0 maz	volts
PEAK AF GRID-No.1 VOLTAGE, Positive-bias value	7 maz	watts
HEATER DISSIPATION	1.4 maz	watts
GRID-No.2 INPUT	200 maz	volts
PEAK HEATER-CATHODE VOLTAGE:		
Heater negative with respect to cathode	200 maz	volts
Heater positive with respect to cathode	200 maz	volts
BUBB TEMPERATURE (At hottest point)	220 maz	°C
■ The dc component must not exceed 100 volts.		

Typical Operation:

Plate Voltage	120	volts
Grid-No.2 Voltage	110	volts
Grid-No.1 (Control-Grid) Voltage	-8	volts
Peak AF Grid-No.1 Voltage	8	volts
Zero-Signal Plate Current	49	ma
Maximum-Signal Plate Current	50	ma
Zero-Signal Grid-No.2 Current	4	ma
Maximum-Signal Grid-No.2 Current	8.5	ma
Plate Resistance (Approx.)	10000	ohms
Transconductance	7500	amhos

AVERAGE PLATE CHARACTERISTICS
PENTODE CONNECTION

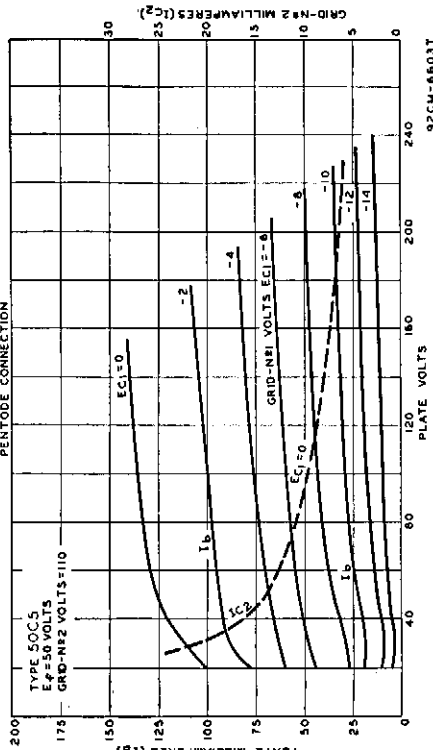

Load Resistance.....	2500	ohms
Total Harmonic Distortion.....	10	per cent
Maximum-Signal Power Output.....	2.3	watts
Maximum Circuit Values:		
Grid-No.1-Circuit Resistance:	0.1 max	megohm
For fixed-bias operation.....	0.5 max	megohm
For cathode-bias operation.....		

INSTALLATION AND APPLICATION

Type 50C5 requires miniature seven-contact socket and may be mounted in any position. OUTLINE 7C, OUTLINES SECTION. It is especially important that this tube, like other power-handling tubes, be adequately ventilated.

The 50-volt heater is designed to operate under the normal conditions of line-voltage variation without materially affecting the performance or serviceability of the 50C5. For operation of the 50C5 in series with other types having 0.15-ampere rating, the current in the heater circuit should be adjusted to 0.15 ampere for the normal supply voltage.

In a series-heater circuit of the "dc power line" type employing several 0.15-ampere types and one or two 50C5s, the heater(s) of the 50C5(s) should be placed on the positive side of the line. Under these conditions, heater-cathode voltage of the 50C5 must not exceed the value given under maximum ratings. In a series-heater circuit of the "universal" type employing rectifier tube 35W4, one or two 50C5s, and several 0.15-ampere types, it is recommended that the heater(s) of the 50C5(s) be placed in the circuit so that the higher values of heater-cathode bias will be impressed on the 50C5(s) rather than on the other 0.15-ampere types. This is accomplished by arranging the 50C5(s) on the side of the supply line which is connected to the cathode of the rectifier, i.e., the positive terminal of the rectified voltage supply. Between this side of the line and the 50C5(s), any necessary auxiliary resistance and the heater of the 35W4 are connected in series.

As a power amplifier (class A₁), the 50C5 is recommended for use either singly or in push-pull combination in the power-output stage of "ac/dc" receivers. The operating values shown under typical operation have been determined on the basis that grid-No.1 current does not flow during any part of the input cycle.

BEAM POWER TUBE

Glass octal type used in output stage of ac/dc receivers. Outline 2B, OUTLINES SECTION. Heater volts (ac/dc), 50; amperes, 0.15. Except for heater rating, this type is identical with glass octal type 6Y6-G. Type 50C6-G is a DISCONTINUED type listed for reference only.

50C6G

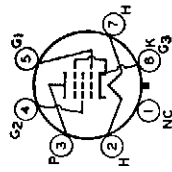

HALF-WAVE VACUUM RECTIFIER

Miniature type used in power supply of ac/dc radio receivers. The heater is provided with a tap for operation of a panel lamp. For typical circuit, refer to type 35W4. Outline 7C, OUTLINES SECTION. Tube requires seven-contact socket and may be mounted in any position.

50DC4

HEATER VOLTAGE (AC/DC):	*	volts
ENTIRE HEATER (PINS 3 AND 4).....	50	volts
PANEL-LAMP SECTION (PINS 4 AND 6).....	7.5	volts
HEATER CURRENT:		
BETWEEN PINS 3 AND 4.....	0.15	ampere
BETWEEN PINS 3 AND 6.....	-	ampere
* Without panel lamp. ** With No.40 or No.47 panel lamp.		

HALF-WAVE RECTIFIER

Maximum Ratings, (Design-Maximum Values):

PEAK INVERSE PLATE VOLTAGE.....	380 max	volts
PEAK PLATE CURRENT.....	720 max	ma
DC OUTPUT CURRENT:		
With Panel Lamp and (No Shunting Resistor.....	70 max	ma
Without Panel Lamp.....	120 max	ma
Without Panel Lamp.....	16.5 max	volts
With Panel Lamp and (Shunting Resistor.....	330 max	volts
Without Panel Lamp.....	330 max	volts

TYPICAL OPERATION WITH PANEL LAMP:†

AC Plate-Supply Voltage (rms).....	117	117	volts	
Filter-Input Capacitor.....	40	40	μf	
Minimum Total Effective Plate-Supply Impedance.....	15	15	ohms	
Panel-Lamp Shunting Resistor.....	450	200	100	ohms
DC Output Current.....	70	80	90	ma

† No.40 or No.47 panel lamp used in circuit with capacitor-input filter given under type 35W4.

TYPICAL OPERATION WITHOUT PANEL LAMP:

AC Plate-Supply Voltage (rms).....	117	volts
Filter-Input Capacitor.....	40	μf
Minimum Total Effective Plate-Supply Impedance.....	15	ohms
DC Output Current.....	110	ma
DC Output Voltage at Input to Filter (Approx.):		
At half-load current (55 ma.).....	130	volts
At full-load current (110 ma.).....	110	volts
Voltage Regulation (Approx.):		
Half-load to full-load current.....	20	volts

* Required when dc output current is greater than 70 milliamperes.

POWER PENTODE

Miniature type used in the audio output stage of radio and television receivers and in phonographs. Outline 7C, OUTLINES SECTION. Heater volts (ac/dc), 50; amperes, 0.15. Except for heater rating, this type is identical with miniature type 6EH5.

50EH5

Related types: 6EH5, 12EH5, 25EH5

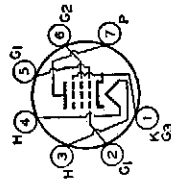

BEAM POWER TUBE

Glass octal type used in audio-output stages of compact stereophonic and monophonic phonographs and radio and television receivers. Outline 14F, OUTLINES SECTION. Tube requires octal socket and may be mounted in any position. Heater volts (ac/dc), 50; amperes, 0.15. Peak heater-cathode volts, heater negative with respect to cathode, 200 max. Except for heater ratings and heater-cathode voltage, this type is identical with glass octal type 6FE5.

50FE5

Related type: 6FE5

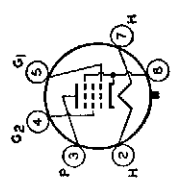

POWER PENTODE

Miniature type used as audio output amplifier in ac/dc radio receivers. Outline 7C, OUTLINES SECTION. Tube requires seven-contact socket and may be operated in any position.

50FK5

HEATER VOLTAGE (AC/DC).....	50	volts
HEATER CURRENT.....	0.1	ampere
DIRECT INTERELECTRODE CAPACITANCES:		
Grid No.1 to Plate.....	0.65	pf
Grid No.1 to Cathode, Heater, Grid No.2, and Grid No.3.....	17	pf
Plate to Cathode, Heater, Grid No.2, and Grid No.3.....	9	pf

CLASS A₁ AMPLIFIER

Maximum Ratings, (Design-Maximum Values):

PLATE VOLTAGE.....	150 max	volts
GRID-NO.2 (SCREEN-GRID) VOLTAGE.....	130 max	volts
GRID-NO.1 (CONTROL-GRID) VOLTAGE, Positive-bias value.....	0 max	volts
PLATE DISSIPATION.....	5 max	watts
GRID-NO.2 INPUT.....	1.75 max	watts
PEAK HEATER-CATHODE VOLTAGE:		
Heater negative with respect to cathode.....	200 max	volts
Heater positive with respect to cathode.....	200*max	volts
BULB TEMPERATURE (At hottest point).....	225 max	°C

Typical Operation and Characteristics:

Plate Supply Voltage.....	110	volts
Grid-No.2 Supply Voltage.....	115	volts
Cathode-Bias Resistor.....	62	ohms
Peak A-F Grid-No.1 Voltage.....	32	volts
Maximum-Signal Plate Current.....	32	ma
Zero-Signal Grid-No.2 Current.....	8.5	ma
Maximum-Signal Grid-No.2 Current.....	12	ma
Plate Resistance (Approx.).....	14000	ohms
Transconductance.....	12800	μmhos
Load Resistance.....	3000	ohms
Total Harmonic Distortion.....	8	per cent
Maximum-Signal Power Output.....	1.2	watts

Maximum Circuit Values:

Grid-No.1-Circuit Resistance:		
For fixed-bias operation.....	0.1	megohm
For cathode-bias operation.....	0.5	megohm

* The dc component must not exceed 100 volts.

AVERAGE PLATE CHARACTERISTICS

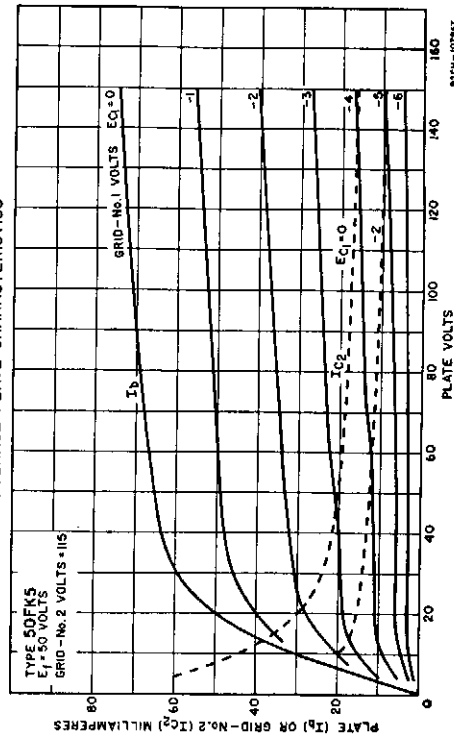

POWER PENTODE

Miniature type used in audio-frequency power-output stage of radio receivers. Outline 7C, OUTLINESSECTION. Tube requires miniature seven-contact socket and may be mounted in any position. The heater is provided with a tap for operation of a panel lamp. Heater volts (ac/dc), 50; amperes, 0.15; tap volts (without panel lamp), 7.

50HK6

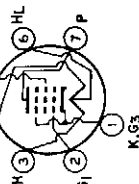

CLASS A₁ AMPLIFIER

Maximum Ratings, (Design-Maximum Values):

PLATE VOLTAGE.....	150 max	volts
GRID-NO.2 (SCREEN-GRID) VOLTAGE.....	130 max	volts
PLATE DISSIPATION.....	5.5 max	watts
GRID-NO.2 INPUT.....	1.1 max	watts
RMS HEATER-TAP VOLTAGE WHEN PANEL LAMP FAILS.....	14 max	volts
PEAK HEATER-CATHODE VOLTAGE:		
Heater negative with respect to cathode.....	200 max	volts
Heater positive with respect to cathode.....	200*max	volts

Typical Operation and Characteristics:

Plate Voltage.....	110	volts
Grid-No.2 Voltage.....	110	volts
Peak A-F Grid-No.1 Voltage.....	-7.5	volts
Zero-Signal Plate Current.....	7.5	volts
Maximum-Signal Plate Current.....	49	ma
Zero-Signal Grid-No.2 Current.....	50	ma
Maximum-Signal Grid-No.2 Current.....	4	ma
Plate Resistance (Approx.).....	8.5	ma
Transconductance.....	10000	ohms
Load Resistance.....	7500	μmhos
Total Harmonic Distortion (Approx.).....	2500	ohms
Maximum-Signal Power Output.....	9	per cent
	1.9	watts

Maximum Circuit Values:

Grid-No.1-Circuit Resistance:		
For fixed-bias operation.....	0.1 max	megohm
For cathode-bias operation.....	0.5 max	megohm

* The dc component must not exceed 100 volts.

BEAM POWER TUBE

Glass octal type used in output stage of ac/dc radio receivers. Outline 14C, OUTLINESSECTION. Tube requires octal socket and may be mounted in any position. This type may be supplied with pin No.1 omitted. Refer to miniature type 50C5 for installation and application information.

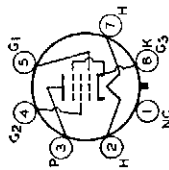

50L6GT

Related types:
12L6GT, 25L6, 25L6GT

HEATER VOLTAGE (AC/DC).....	50	volts
HEATER CURRENT.....	0.15	ampere
DIRECT INTERELECTRODE CAPACITANCES (Approx.):		
Grid No.1 to Plate.....	0.6	pf
Grid No.1 to Cathode, Heater, Grid No.2, and Grid No.3.....	15	pf
Plate to Cathode, Heater, Grid No.2, and Grid No.3.....	9.5	pf

CLASS A₁ AMPLIFIER

Maximum Ratings, (Design-Center Values):

PLATE VOLTAGE.....	200 max	volts
GRID-NO.2 (SCREEN-GRID) VOLTAGE.....	125 max	volts
PLATE DISSIPATION.....	10 max	watts
GRID-NO.2 INPUT.....	1.25 max	watts
PEAK HEATER-CATHODE VOLTAGE:		
Heater negative with respect to cathode.....	90 max	volts
Heater positive with respect to cathode.....	90 max	volts

Typical Operation:

Plate Supply Voltage.....	110	Fixed Bias	Cathode Bias
Grid-No.2 Supply Voltage.....	110	200	volts
Grid-No.1 (Control-Grid) Voltage.....	310	125	volts
Peak A-F Grid-No.1 Voltage.....	-7.5	-	volts
Cathode-Bias Resistor.....	7.5	8.0	volts
Zero-Signal Plate Current.....	-	180	ohms
Maximum-Signal Plate Current.....	49	46	ma
Zero-Signal Grid-No.2 Current.....	50	47	ma
Maximum-Signal Grid-No.2 Current.....	4	2.2	ma
	10	8.5	ma

Plate Resistance (Approx.)	13000
Transconductance	8000
Load Resistance	2000
Total Harmonic Distortion	10
Maximum-Signal Power Output	2.1

VACUUM RECTIFIER-DOUBLER

Lock-in type used as half-wave rectifier or voltage doubler in ac/dc receivers. Outline 13B, OUTLINES SECTION. Tube requires lock-in socket. Heater volts (ac/dc), 50; amperes, 0.15. This type is electrically identical with glass octal type 50Y6-GT and, except for heater rating, with glass octal type 25Z6-GT. Refer to type 25Z6-GT for maximum ratings, typical operation, and curves. Type 50X6 is used principally for renewal purposes.

50X6



VACUUM RECTIFIER-DOUBLER

Glass octal type used as half-wave rectifier or voltage doubler in ac/dc receivers. This type is used particularly in "transformerless" receivers of either the ac/dc type or the voltage-doubler type. Outline 14C, OUTLINES SECTION. This type may be supplied with pin No.1 omitted. Tube requires octal socket. Heater volts (ac/dc), 50; amperes, 0.15. Except for heater rating, this type is electrically identical with type 25Z6-GT.

50Y6GT

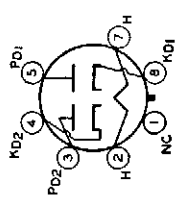

VACUUM RECTIFIER-DOUBLER

Glass octal type used as half-wave rectifier or voltage doubler in ac/dc receivers. This type is used particularly in "transformerless" receivers of either the ac/dc type or the voltage-doubler type. The heater is provided with a tap for operation of a panel lamp. Outline 14 C, OUTLINES SECTION. Tube requires octal socket. Without panel lamp, heater volts (ac/dc) of entire heater (pins 2 and 7), 50; amperes, 0.15. With panel lamp, heater volts (ac/dc) of panel-section (pins 6 and 7) with 0.15 ampere between pins 2 and 7, 5.5. For maximum ratings and typical operation as half-wave rectifier or voltage doubler without panel lamp, refer to glass octal type 25Z6-GT. When operated with a panel lamp and 250-ohm panel-lamp shunting resistor, ratings and typical operation are the same as for type 25Z6-GT, except that dc output current per plate is 65 ma. Type 50Y7-GT is used principally for renewal purposes.

50Y7GT

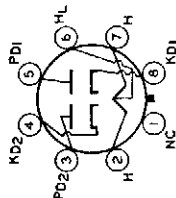

VACUUM RECTIFIER-DOUBLER

Glass octal type used as half-wave rectifier or voltage doubler in ac/dc receivers. Outline 22, OUTLINES SECTION. The heater is provided with a tap for operation of a panel lamp. Without panel lamp, heater volts (ac/dc) of entire heater (pins 2 and 7), 50; amperes, 0.15. With panel lamp, heater volts (ac/dc) of panel-section (pins 6 and 7) with 0.15 ampere between pins 2 and 7, 2. Maximum ratings as rectifier or doubler: peak inverse plate volts, 700 maz; peak plate ma. per plate, 400 maz; dc output ma. per plate with panel lamp, 65 maz; peak heater-cathode volts, 350 maz; panel lamp section volts (pins 6 and 7), 2.5 maz. This is a DISCONTINUED type listed for reference only.

50Z7G

HIGH-MU TWIN POWER TRIODE

Glass type used in output stage of ac-operated receivers as a class B power amplifier. Outline 27, OUTLINES SECTION. Tube requires medium seven-contact (0.855-inch pin-circle diameter) socket. Heater volts (ac/dc), 2.5; amperes, 2.0. Except for heater rating, this type is electrically identical with metal type 6N7. Type 53 is a DISCONTINUED type listed for reference only.

53

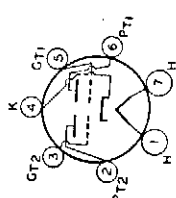

POWER PENTODE

Miniature type used in output stages of audio amplifiers, especially in two-tube series-string stereo systems. This type has extremely high power-sensitivity and can be driven to full output by a ceramic or crystal phonograph pickup. Outline 7C, OUTLINES SECTION. Tube requires seven-contact socket and may be mounted in any position.

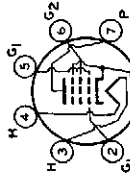

60FX5
Related type:
12FX5

HEATER VOLTAGE (AC/DC)	60	volts
HEATER CURRENT	0.1	ampere
DIRECT INTERELECTRODE CAPACITANCES (Approx.):		
Grid No.1 to Plate	0.45	pf
Grid No.1 to Cathode, Heater, Grid No.2, and Grid No.3	0.17	pf
Plate to Cathode, Heater, Grid No.2, and Grid No.3	9	pf

CLASS A₁ AMPLIFIER

Maximum Ratings, (Design-Maximum Values):

PLATE VOLTAGE	150	maaz
GRID-NO.2 (SCREEN-GRID) VOLTAGE	130	maaz
PLATE DISSIPATION	5	3 maaz
GRID-NO.2 INPUT	2	maaz
PEAK HEATER-CATHODE VOLTAGE:		
Heater negative with respect to cathode	200	maaz
Heater positive with respect to cathode	200	maaz
BULB TEMPERATURE (At hottest point)	225	maaz

Typical Operation:

Plate Supply Voltage	110	volts
Grid-No.2 Supply Voltage	115	volts
Cathode-Bias Resistor	62	ohms
Peak AF Grid-No.1 Voltage	3	volts
Zero-Signal Plate Current	36	ma
Maximum-Signal Plate Current	35	ma
Zero-Signal Grid No.2 Current	10	ma
Maximum-Signal Grid No.2 Current	12	ma
Plate Resistance	17500	ohms
Transconductance	18500	ohms
Load Resistance	8000	ohms
Total Harmonic Distortion	8	per cent
Maximum-Signal Power Output	1.3	watts

Maximum Circuit Values:

Grid-No.1-Circuit Resistance:	0.1	maaz
For fixed-bias operation	0.5	maaz
For cathode-bias operation		megohm
		megohm

AVERAGE CHARACTERISTICS

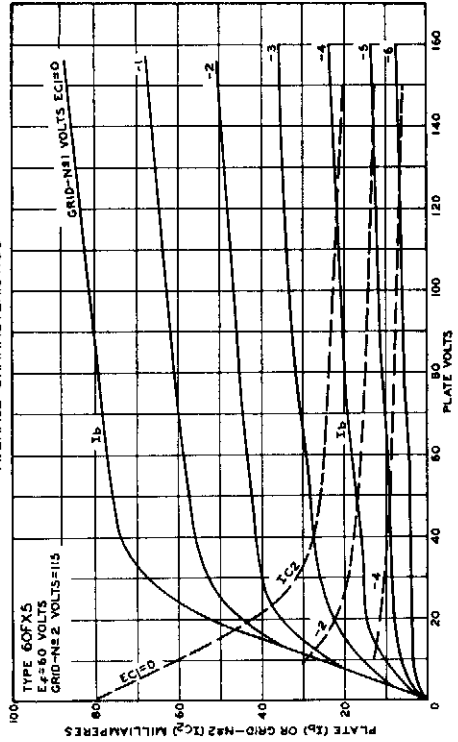

70L7GT

RECTIFIER—BEAM POWER TUBE

Glass octal type used as combined half-wave rectifier and output amplifier in ac/dc receivers. Outline 14E, OUTLINES SECTION. Tube requires octal socket. Heater volts (ac/dc), 70; amperes, 0.15. Maximum ratings of rectifier unit: peak inverse plate volts, 350; peak heater ma., 420; dc output ma., 70; peak heater-cathode volts, 175; minimum total effective plate-supply impedance, 15 ohms. Typical operation and maximum ratings of beam power unit as class A₁ amplifier: plate and grid-No.2 volts, 110 (117 maz); grid-No.1 volts, -7.5; plate ma., 40; grid-No.2 ma., 3; plate resistance, 15000 ohms; transconductance, 7500 μmhos; load resistance, 2000 ohms; output watts, 1.8; plate dissipation, 5 maz watts; grid-No.2 input, 1 maz watt. This type is used principally for renewal purposes.

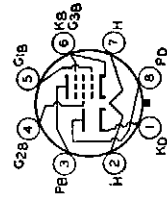

75

TWIN DIODE—HIGH-MU TRIODE

Glass type used as combined detector, amplifier, and avc tube in radio receivers. Outline 24B, OUTLINES SECTION. Tube requires six-contact socket. Heater volts (ac/dc), 6.3; amperes, 0.3. Except for interelectrode capacitances and plate volts of 250 maz, this type is identical electrically with metal type 6SQ7. Type 75 is used principally for renewal purposes.

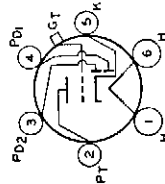

78

REMOTE-CUTOFF PENTODE

Glass type used in rf and if stages of radio receivers, particularly those employing avc. Outline 24B, OUTLINES SECTION. Tube requires six-contact socket. Heater volts (ac/dc), 6.3; amperes, 0.3. Except for capacitances, this type is identical electrically with metal type 6K7. Type 78 is used principally for renewal purposes.

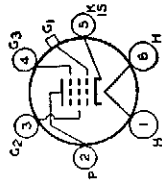

80

FULL-WAVE VACUUM RECTIFIER

Glass type used in power supply of radio equipment having moderate direct-current requirements. Outline 27, OUTLINES SECTION, except maximum over-all length 4 inches; maximum seated length, 3-3/8 inches. Tube requires four-contact socket and should be mounted preferably in a vertical position. Horizontal mounting is permissible if pins 1 and 4 are in a horizontal plane. Filament volts (ac), 5.0; amperes, 2.0. For filament operation, refer to type 5U4-G. Type 80 is electrically identical with glass octal type 5Y3-CT. Type 80 is used principally for renewal purposes.

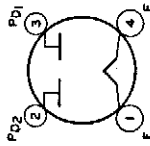

84/6Z4

FULL-WAVE VACUUM RECTIFIER

Glass type used in power supply of automobile and ac-operated radio receivers. Maximum dimensions: over-all length, 4-3/16 inches; seated height, 3-9/16 inches; diameter, 1-9/16 inches. Tube requires five-contact socket. Heater volts (ac/dc), 6.3; amperes, 0.5. Maximum ratings: peak inverse plate volts, 1250 maz; peak plate ma., 180 maz; dc output ma., 60 maz; peak heater-cathode volts, 450 maz. Typical operation with capacitor-input filter: ac plate-to-plate supply volts (rms), 450; minimum total effective plate-supply impedance per plate, 150 ohms; dc output ma., 60. Typical operation with choke-input filter: ac plate-to-plate supply volts (rms), 900; minimum filter-input choke, 10 henries; dc output ma., 60. This type is used principally for renewal purposes.

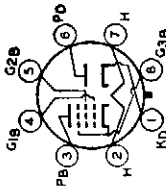
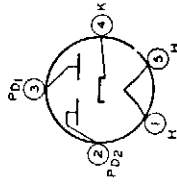

117L7/M7GT

RECTIFIER—BEAM POWER TUBE

Glass octal type used as combined half-wave rectifier and output amplifier in ac/dc receivers. Outline 14E, OUTLINES SECTION. Tube requires octal socket. Heater volts (ac/dc), 117; amperes, 0.09. For ratings and operation of rectifier unit, refer to type 117N7-GT. Typical operation of beam power unit as class A₁ amplifier: plate and grid-No.2 volts, 105 (117 maz); grid-No.1 volts, -5.2; peak at grid-No.1 volts, 5.2; plate ma., 43; grid-No.2 ma., 4 (zero-signal); 5.5 (maximum-signal); plate input, 6 maz watts; grid-No.2 dissipation, 1 maz watt; plate resistance (approx.), 17000 ohms; transconductance, 5800 μmhos; load resistance, 4000 ohms; total harmonic distortion, 5 per cent; maximum-signal power output, 0.85 watt. Type 117L7/M7-GT is used principally for renewal purposes.

RECTIFIER—BEAM POWER TUBE

Glass octal type used as combined half-wave rectifier and output amplifier in ac/dc receivers. Outline 14E, OUTLINES SECTION. Tube requires octal socket and may be mounted in any position. Heater volts (ac/dc), 117; amperes, 0.09. Maximum ratings of rectifier unit as half-wave rectifier: peak inverse plate volts, 350 maz; peak plate ma., 450 maz; dc output ma., 75 maz; peak heater-cathode volts (heater negative with respect to cathode), 175 maz. Typical operation with capacitor-input filter: ac plate supply volts (rms), 177; minimum total effective plate-supply impedance, 15 ohms; dc output ma., 75; dc output volts at input to filter, 122. Typical operation of beam power unit as class A₁ amplifier: plate and grid-No.2 volts, 100 (117 maz); grid-No.1 volts, -6; peak at grid-No.1 volts, 6; plate ma., 51; grid-No.2 ma., 5; plate dissipation, 5.5 maz; grid-No.2 input, 1 maz watt; plate resistance (approx.), 16000 ohms; transconductance, 7000 μmhos; load resistance, 3000 ohms; total harmonic distortion, 6 per cent; maximum-signal power output, 1.2 watts. This type is used principally for renewal purposes.

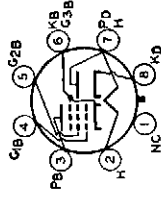

78

RECTIFIER—BEAM POWER TUBE

Glass octal type used as combined half-wave rectifier and output tube. Outline 14E, OUTLINES SECTION. Tube requires octal socket. Heater volts (ac/dc), 117; amperes, 0.09. This type is electrically identical with glass octal type 117L7/M7-GT. Type 117P7-GT is used principally for renewal purposes.

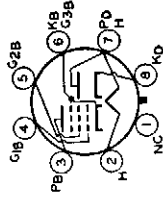

80

HALF-WAVE VACUUM RECTIFIER

Miniature type used in power supply of ac/dc battery radio receivers. The heater is designed for operation directly across a 117-volt ac or dc supply line. Outline 7C, OUTLINES SECTION. Tube requires miniature seven-contact socket. This tube, like other power-heating tubes, must be adequately ventilated. Heater volts (ac/dc), 117; amperes, 0.04. Maximum ratings for half-wave rectifier service: peak inverse plate volts, 350 maz; peak plate ma., 540 maz; dc output ma., 90 maz; peak heater-cathode volts: heater negative with respect to cathode, 175 maz; heater positive with respect to cathode, 100 maz. This type is used principally for renewal purposes.

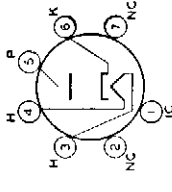

117Z4GT

HALF-WAVE VACUUM RECTIFIER

Glass octal type used in power supply of ac/dc battery radio receivers. Maximum over-all length, 3 inches; maximum diameter, 1-5/16 inches. Tube requires octal socket. Heater volts (ac/dc), 117; amperes, 0.04. Maximum ratings as half-wave rectifier: peak inverse plate volts, 350 maz; peak plate ma., 540 maz; peak heater-cathode volts, 175 maz. Typical operation with capacitor-input filter: ac plate supply volts (rms), 117; minimum total effective plate-supply impedance, 30 ohms; dc output ma., 90. This is a DISCONTINUED type listed for reference only.

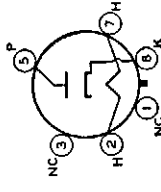

VACUUM RECTIFIER-DOUBLER

Glass octal type used as half-wave rectifier or voltage doubler in ac/dc receivers. Outline 14C, OUTLINES SECTION. Tube requires octal socket and may be mounted in any position. This type may be supplied with pin No.1 omitted. Heater volts (ac/dc), 11.7; amperes, 0.075. Maximum ratings: peak inverse plate volts, 700 max; peak plate ma. per plate, 360 max; dc output ma. per plate, 60 max; peak heater-cathode volts, 350 max. Typical operation as half-wave rectifier with capacitor-input filter or as half-wave or full-wave voltage doubler: ac plate supply volts per plate (rms), 117; filter-input capacitor, 50 μ f; minimum total effective plate-supply impedance per plate, 15 (30 for half-wave doubler service); dc output ma. per plate, 60. This type is used principally for renewal purposes.

117Z6GT

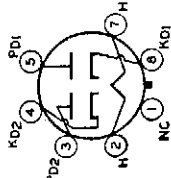

SHARP-CUTOFF PENTODE

Miniature type used as audio amplifier in applications requiring reduced microphonics, leakage noise, and hum. Especially useful in the input stages of medium-gain public-address systems, home sound recorders, and general-purpose audio systems. Outline 8B, OUTLINES SECTION. Tube requires miniature nine-contact socket and may be mounted in any position. For operation as resistance-coupled amplifier, refer to RESISTANCE-COUPLED AMPLIFIER SECTION.

5879

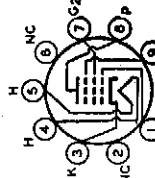

HEATER VOLTAGE (AC/DC).....	6.3	volts
HEATER CURRENT.....	0.15	ampere
DIRECT INTERELECTRODE CAPACITANCES:		
Grid No.1 to Plate.....	0.11 max	pf
Grid No.1 to Cathode, Heater, Grid No.2, and Grid No.3.....	2.7	pf
Plate to Cathode, Heater, Grid No.2, and Grid No.3.....	2.4	pf
Triode Connections*:		
Grid No.1 to Plate.....	1.4	pf
Grid No.1 to Cathode and Heater.....	1.4	pf
Plate to Cathode and Heater.....	0.85	pf

* Grid No.2 and grid No.3 connected to plate.

CLASS A₁ AMPLIFIER

Maximum Ratings, (Design-Maximum Values):	Triode Connection*	330 max	volts
PLATE VOLTAGE.....	275 max		

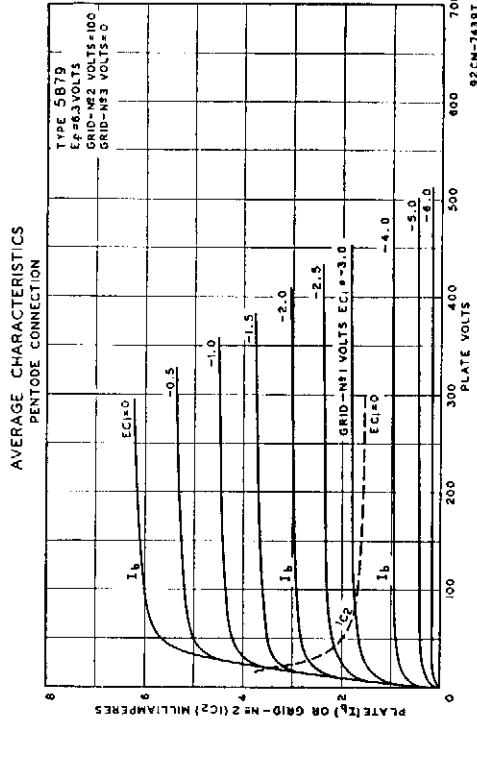

GRID-NO.2 (SCREEN-GRID) VOLTAGE.....	Triode Connection*	Pentode Connection
GRID-NO.2 SUPPLY VOLTAGE.....	-	See curve page 70
GRID-NO.1 (CONTROL-GRID) VOLTAGE:		380 max
Negative-bias value.....	-55 max	volts
Positive-bias value.....	0 max	volts
PLATE DISSIPATION.....	1.7 max	watts
GRID-NO.2 INPUT:		
For grid-No.2 voltages up to 165 volts.....	-	0.25 max
For grid-No.2 voltages between 165 and 350 volts.....	-	See curve page 70
PEAK HEATER-CATHODE VOLTAGE:		
Heater negative with respect to cathode.....	100 max	volts
Heater positive with respect to cathode.....	100 max	volts

Characteristics:

Plate Voltage.....	100	250	250
Grid No.3.....	-	-	Connected to cathode at socket
Grid-No.2 Voltage.....	-3	-3	volts
Grid-No.1 Voltage.....	21	21	volts
Amplification Factor.....	0.017	0.0137	2
Plate Resistance (Approx.).....	1240	1530	megohms
Transconductance.....	-	-	1000
Grid-No.1 Voltage (Approx.) for plate current of 10 μ a.....	2.2	5.5	-8
Plate Current.....	-	-	1.8
Grid-No.2 Current.....	-	-	0.4

Maximum Circuit Value:

Grid-No.1-Circuit Resistance.....	2.2 max	megohms
-----------------------------------	---------	---------

* Grid No.2 and grid No.3 connected to plate.

AVERAGE CHARACTERISTICS

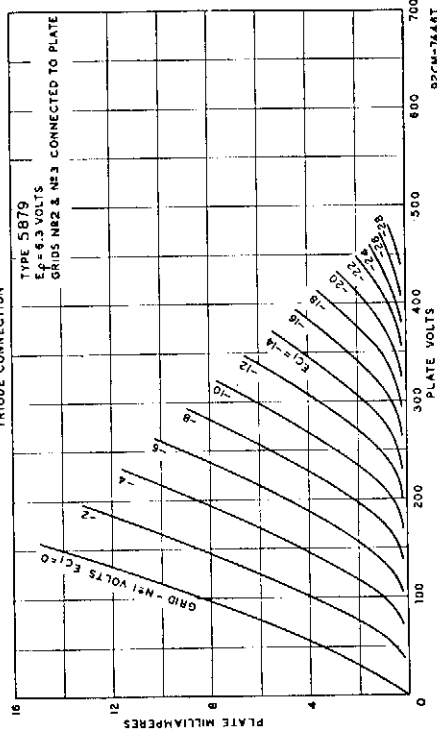

BEAM POWER TUBE

Glass octal type used in the output stages of radio receivers and audio amplifiers, particularly in the push-pull stages of high-fidelity audio amplifiers. Maximum dimensions: over-all length, 3-15/32 inches; seated height, 2-29/32 inches; diameter, 1-7/16 inches. Tube requires octal socket and may be mounted in any position. For typical operation as push-pull class A₁, class AB₁ (within maximum ratings), and class AB₂ amplifier, and for curves of average plate characteristics, refer to type 6L6-GC. Heater volts (ac/dc), 6.3; amperes, 0.9.

5881

CLASS A₁ AMPLIFIER

Maximum Ratings, (Design-Center Values):

PLATE VOLTAGE.....	400 max	Pentode Connection	400 max
GRID-NO.2 (SCREEN-GRID) VOLTAGE.....	400 max	Triode Connection*	400 max
PLATE DISSIPATION.....	28 maz		28 maz
GRID-NO.2 INPUT.....	3 maz		3 maz
PEAK HEATER-CATHODE VOLTAGE:			
Heater negative with respect to cathode.....	200 maz		200 maz
Heater positive with respect to cathode.....	200 maz		200 maz

Typical Operation and Characteristics:

Plate Voltage.....	250	300
Grid-No.2 Voltage.....	250	350
Grid-No.1 (Control-Grid) Voltage.....	-18	-20
Peak AF Grid-No.1 Voltage.....	18	20
Zero-Signal Plate Current.....	52	78
Maximum-Signal Plate Current.....	58	85
Zero-Signal Grid-No.2 Current.....	4.3	2.5
Maximum-Signal Grid-No.2 Current.....	7.6	8.5
Amplification Factor.....	8	
Plate Resistance (Approx.).....	30000	48000
Transconductance.....	5250	8200
Load Resistance.....	4000	4000
Total Harmonic Distortion.....	6	5.5
Maximum-Signal Power Output.....	1.4	1.8

Maximum Circuit Values:

Grid-No.1-Circuit Resistance:	0.1 maz	megohm
For fixed-bias operation.....	0.5 maz	megohm
For cathode-bias operation.....		
* Grid No.2 connected to plate.		

BEAM POWER TUBE

Miniature type used as power amplifier in compact high-fidelity audio equipment. Tube features linear operation over a wide range of power, high power sensitivity, high stability, and is capable of delivering high power output at low distortion.

6973

Double base-pin connections for both grid No.1 and grid No.2 provide cool operation of grids and thus minimize grid emission and permit use of high values of grid-circuit resistance to reduce driving power. Outline 8E, OUTLINESSECTION. Tube requires miniature nine-contact socket and may be mounted in any position.

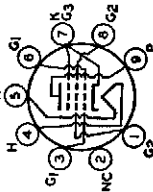

HEATER VOLTAGE (AC/DC).....	6.3	volts
HEATER CURRENT.....	0.45	ampere
DIRECT INTERELECTRODE CAPACITANCES:		
Grid No.1 to Plate.....	0.4	maz
Grid No.1 to Cathode, Heater, Grid No.2, and Grid No.3.....	9	pf
Plate to Cathode, Heater, Grid No.2, and Grid No.3.....	6	pf

CLASS A₁ AMPLIFIER

Characteristics:

Plate Voltage.....	250	volts
Grid-No.2 (Screen-Grid) Voltage.....	250	volts
Grid-No.1 (Control-Grid) Voltage.....	-15	volts
Plate Resistance (Approx.).....	73000	ohms
Transconductance.....	4800	amhos
Plate Current.....	45	ma
Grid-No.2 Current.....	8.5	ma
Grid-No.1 Voltage (Approx.) for plate current of 100 μ a.....	-40	volts

PUSH-PULL CLASS AB₁ AMPLIFIER

Maximum Ratings, (Design-Maximum Values):

PLATE VOLTAGE.....	440 maz	volts
GRID-NO.2 VOLTAGE.....	330 maz	volts
PLATE DISSIPATION.....	12 maz	watts
GRID-NO.2 INPUT.....	2 maz	watts

AVERAGE CHARACTERISTICS WITH EC₂ AS VARIABLE

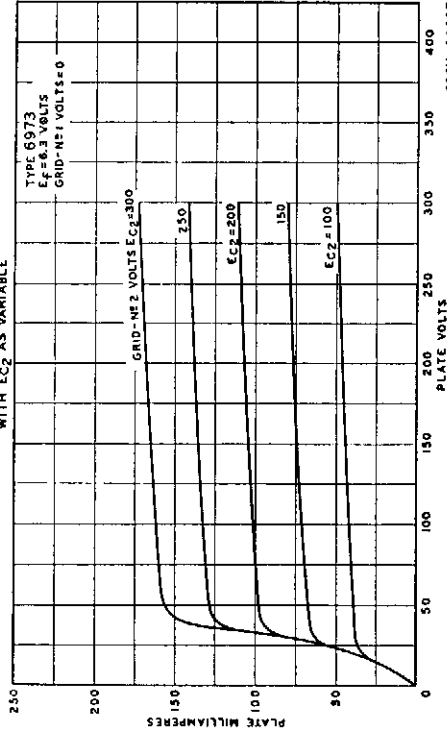

PEAK HEATER-CATHODE VOLTAGE: Heater negative with respect to cathode..... 200 maz
Heater positive with respect to cathode..... 200 maz
BUBB TEMPERATURE (At hottest point)..... 250 maz

Typical Operation, (Values are for two tubes):

Plate Supply Voltage.....	250	350	400	400	310	volts
Grid-No.2 Supply Voltage.....	250	280	290	300	310	volts
Grid-No.1 Voltage.....	-15	-22	-25	-	-	volts
Cathode-Bias Resistor.....	-	-	-	230	270	ohms
Peak AF Grid-No.1-to-Grid-No.1 Voltage.....	30	44	50	48	55	volts
Zero-Signal Plate Current.....	92	58	50	80	77	ma
Maximum-Signal Plate Current.....	105	106	107	96	92	ma
Zero-Signal Grid-No.2 Current.....	7	3.5	2.5	6	5	ma
Maximum-Signal Grid-No.2 Current.....	16	14	13.7	14	14	ma
Effective Load Resistance (Plate-to-plate).....	8000	7500	8000	5500	6000	ohms
Total Harmonic Distortion.....	2	1.5	2	2	4	per cent
Maximum-Signal Power Output.....	12.5	20	24	15	17	watts

Maximum Circuit Values:

Grid-No.1-Circuit Resistance:	0.5 maz	megohm
For fixed-bias operation.....	1 maz	megohm
For cathode-bias operation.....		
* The dc component must not exceed 100 volts.		

AVERAGE CHARACTERISTICS WITH EC₁ AS VARIABLE

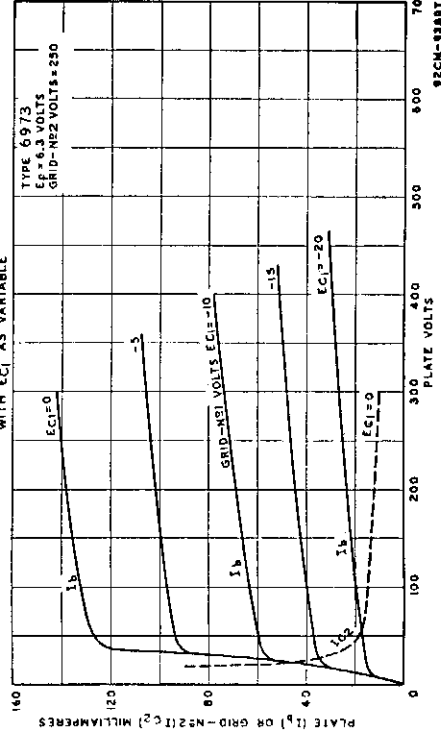

PUSH-PULL CLASS AB₁ AMPLIFIER

Grid No. 2 of Each Tube Connected to Tap on Plate Winding of Output Transformer

Maximum Ratings, (Design-Maximum Values):	Fixed Bias	Cathode Bias
PLATE AND GRID-NO.2 SUPPLY VOLTAGE.....	410 max	370
PLATE DISSIPATION.....	12 maz	—
GRID-NO.2 INPUT.....	1.75 maz	—
PEAK HEATER-CATHODE VOLTAGE:		
Heater negative with respect to cathode.....	200 maz	—
Heater positive with respect to cathode.....	200* maz	—
BULB TEMPERATURE (At hottest point).....	250 maz	—

Typical Operation, (Values are for two tubes):	Fixed Bias	Cathode Bias
Plate Supply Voltage.....	375	370
Grid-No.2 Supply Voltage.....	—	—
Grid-No.1 Voltage*.....	-33.5	—
Cathode-Bias Resistor.....	67	355
Peak A-F Grid-No.1-to-Grid-No.1 Voltage.....	62	62
Zero-Signal Cathode Current.....	95	74
Maximum-Signal Cathode Current.....	12500	84
Effective Load Resistance (Plate-to-plate).....	1.5	13000
Total Harmonic Distortion.....	1.2	—
Maximum-Signal Power Output.....	18.5	15

Maximum Circuit Values*

Grid-No.1-Circuit Resistance:
 For fixed-bias operation..... 0.5 maz megohm
 For cathode-bias operation..... 1 maz megohm

* The dc component must not exceed 100 volts.
 † Obtained from taps on the primary winding of the output transformer. The taps are located on each side of the center tap (B+) so as to apply 50 per cent of the plate signal voltage to grid No.2 of each output tube.
 ‡ Obtained from taps on the primary winding of the putput transformer. The taps are located on each side of the center tap (B+) so as to supply 40 per cent of the plate signal voltage to grid No.2 of each output tube.
 § The type of input-coupling network used should not introduce too much resistance in the grid-No.1 circuit. Transformer- or impedance-coupling devices are recommended.

7025

HIGH-MU TWIN TRIODE

Miniature type used as phase inverter or resistance-coupled amplifier in high-quality, high-fidelity audio amplifiers where low noise and hum are primary considerations. Outline 8B, OUTLINES SECTION. This type is identical with miniature type 12AX7 except that it has a controlled equivalent noise and hum characteristic. For operation as resistance-coupled amplifier, RESISTANCE-COUPLED AMPLIFIER SECTION.

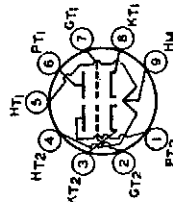

Equivalent-Noise and Hum Voltage Referenced to Grid, (Each U_{rim}):

Average Value (rms)†.....	1.8	avolts
Maximum Value (rms)*.....	7	avolts

† Measured in "true rms" units under following conditions: heater volts (ac), 6.3 (parallel connection); center tap of heater transformer connected to ground; plate supply volts, 250; plate load resistor, 2700 ohms; cathode-bypass capacitor, 100 μf; grid resistor, 0 ohms; and amplifier covering frequency range between 25 to 10000 cycles per second.
 * Same conditions as for "Average Value", except: cathode resistor is unby-passed and grid resistor, 0.05 megohm.

BEAM POWER TUBE

Glass octal types used in push-pull power amplifier circuits of high-fidelity audio equipment. Tubes provide high powersensitivity and high stability and are capable of delivering high power output at low distortion. Double base-pin connections for both grid No.1 and grid No.2 provide for flexibility of circuit arrangement and also cool operation of the grids with the result that reverse grid current is minimized. Outline 19D, OUT-

7027

7027A

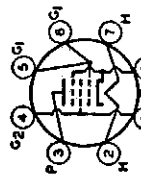

LINES SECTION, except diameter is 1-5/8 inches max. Tubes require octal socket and may be mounted in any position. It is especially important that these tubes, like other power-handling tubes, be adequately ventilated. Type 7027 is a DISCONTINUED type listed for reference only.

HEATER VOLTAGE (AC/DC).....	6.3	volts
HEATER CURRENT.....	0.9	ampere
DIRECT INTERELECTRODE CAPACITANCES (Approx.):		
Grid No.1 to Plate.....	1.5	pf
Plate to Cathode, Heater, Grid No.2, and Grid No.3.....	10	pf
Plate to Cathode, Heater, Grid No.2, and Grid No.3.....	7.5	pf

CLASS A₁ AMPLIFIER

Characteristics:		
Plate Voltage.....	250	volts
Grid-No.2 (Screen-Grid) Voltage.....	250	volts
Grid-No.1 (Control-Grid) Voltage.....	-14	volts
Plate Resistance (Approx.).....	22500	ohms
Transconductance.....	6000	μmhos
Plate Current.....	72	ma
Grid-No.2 Current.....	5	ma

PUSH-PULL CLASS AB₁ AMPLIFIER

Maximum Ratings for 7027-A₁ (Design-Maximum Values):

PLATE VOLTAGE.....	600 max	volts
GRID-NO.2 VOLTAGE.....	500 max	volts
PLATE DISSIPATION.....	35 maz	watts
GRID-NO.2 INPUT.....	5 maz	watts
PEAK HEATER-CATHODE VOLTAGE:		
Heater negative with respect to cathode.....	200 max	volts
Heater positive with respect to cathode.....	200* maz	volts

Typical Operation for 7027-A₁ (Values are for two tubes):

	Fixed Bias	Cathode Bias
Plate Supply Voltage.....	400	400
Grid-No.2 Supply Voltage.....	450	540
Grid-No.1 Voltage.....	300	400
Cathode-Bias Resistor.....	-25*	-38*
Peak A-F Grid-No.1-to-Grid-No.1 Voltage.....	—	200
Zero-Signal Plate Current.....	50	60
Maximum-Signal Plate Current.....	102	95
Zero-Signal Grid-No.2 Current.....	152	194
Maximum-Signal Grid-No.2 Current.....	6	3.4
Effective Load Resistance (Plate-to-Plate).....	17	19.2
Effective Load Resistance (Plate-to-Plate).....	6600	6500
Effective Load Resistance (Plate-to-Plate).....	6600	6600
Effective Load Resistance (Plate-to-Plate).....	4500	4500
Effective Load Resistance (Plate-to-Plate).....	3800	3800

AVERAGE PLATE CHARACTERISTICS

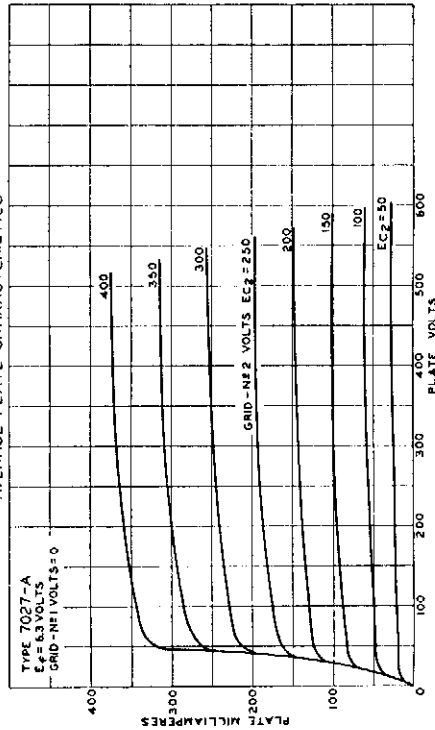

DIRECT INTERELECTRODE CAPACITANCES:

Triode Unit:		
Grid to Plate	2	pf
Grid to Cathode and Heater	2.3	pf
Plate to Cathode and Heater	0.3	pf
Pentode Unit:		
Grid No.1 to Plate	0.06	max
Grid No.1 to Cathode, Heater, Grid No.2, Grid No.3, and Internal Shield	5	pf
Plate to Cathode, Heater, Grid No.2, Grid No.3, and Internal Shield	2	pf

Equivalent-Noise and Hum Voltage Referenced to Grid:

Median Value (rms)	Triode Unit	Pentode Unit
	10 μ	35 μ
Maximum Value (rms)	150 μ	100 μ

† Measured in "true rms" units under the following conditions: heater volts (ac), 6.3; center tap of heater transformer connected to ground; plate-supply volts, 250; plate load resistor, 0.1 megohm; cathode resistor, 1500 ohms; grid resistor, 0.05 megohm; and amplifier covering frequency range between 25 and 10000 cycles per second.

• Same conditions as for triode unit except: grid-No.2 supply volts, 250; grid-No.2 resistor, 0.38 megohm; grid-No.2-bypass capacitor, 0.22 μ f; cathode resistor, 1200 ohms; and grid-No.1 resistor, 0.05 megohm.

CLASS A₁ AMPLIFIER

Maximum Ratings, (Design-Maximum Values):

PLATE VOLTAGE	Triode Unit	Pentode Unit
GRID-NO.2 (SCREEN-GRID) VOLTAGE	380 max	380 max
GRID-NO.2 SUPPLY VOLTAGE	—	See curve page 70
GRID-NO.1 (CONTROL-GRID) VOLTAGE, Positive-bias value	0 max	0 max
PLATE DISSIPATION	2.4 max	3 max
GRID-NO.2 INPUT:		
For grid-No.2 voltages up to 165 volts	—	0.6 max
For grid-No.2 voltages between 165 and 380 volts	200 max	200 max
PEAK HEATER-CATHODE VOLTAGE:	200 μ max	200 μ max
Heater positive with respect to cathode	—	—
Heater negative with respect to cathode	—	—

Characteristics:

Plate Supply Voltage	Triode Unit	Pentode Unit	
Grid No.2 Supply Voltage	215	100	220
Grid-No.1 Voltage	—	50	130
Cathode-Bias Resistor	—	1000	62
Amplification Factor	17	—	0.4
Plate Resistance (Approx.)	0.0081	1500	7000
Transconductance	2100	—	—
Grid-No.1 Voltage (Approx.) for plate current of 10 μ a	-40	1.1	12.5
Plate Current	9	—	3.5
Grid-No.2 Current	—	0.35	—

AVERAGE CHARACTERISTICS, TRIODE UNIT

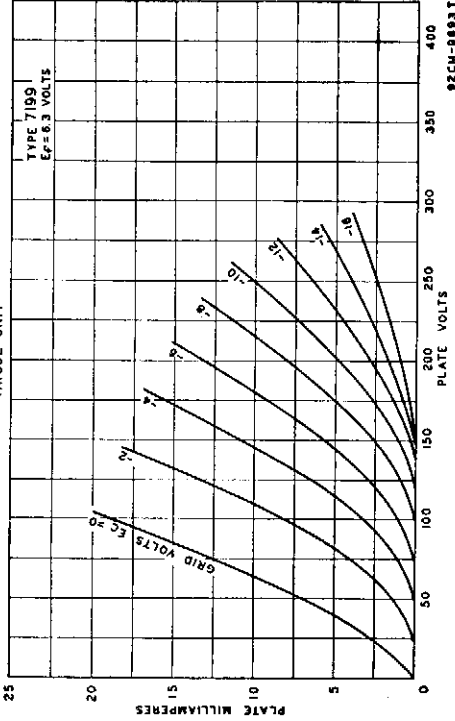

Maximum Circuit Values:

Grid-No.1-Circuit Resistance*	Triode Unit	Pentode Unit
For fixed-bias operation	0.5 max	0.25 max
For cathode-bias operation	1.0 max	1.0 max

* The dc component must not exceed 100 volts.

• If either unit is operated at maximum rated conditions, grid-No.1-circuit resistance for both units should not exceed the stated values.

AVERAGE CHARACTERISTICS, PENTODE UNIT

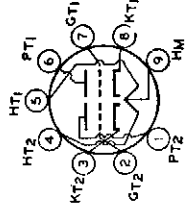
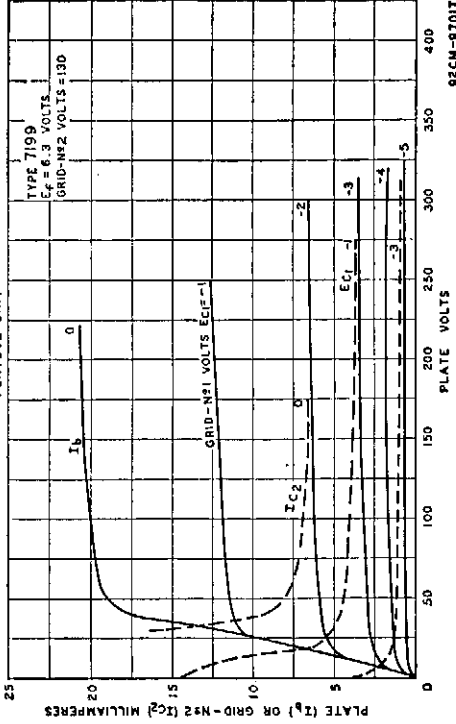

DUAL TRIODE

Miniature type used for combined first- and second-stage audio preamplification in high-fidelity phonograph or tape equipment. Tube has high- μ unit and medium- μ u unit. Outline 8B.

OUTLINES SECTION. Tube requires miniature nine-contact socket and may be operated in any position. Heater volts (ac/dc), 12.6 (series), 6.3 (parallel); amperes, 0.15 (series), 0.3 (parallel).

7247

CLASS A₁ AMPLIFIER

Maximum Ratings, (Design-Maximum Values):

PLATE VOLTAGE	Unit No.1	Unit No.2
GRID VOLTAGE:	380 max	380 max
Negative-bias value	55 max	55 max
Positive-bias value	0 max	0 max
CATHODE CURRENT	22 max	22 max
PLATE DISSIPATION	1.2 max	3 max
PEAK HEATER-CATHODE VOLTAGE:		
Heater negative with respect to cathode	200 max	200 max
Heater positive with respect to cathode	200 μ max	200 μ max

Characteristics:

Plate Voltage	Unit No.1	Unit No.2
Grid Voltage	100	250
Amplification Factor	-1	-2
Plate Resistance (Approx.)	100	100
Transconductance	80000	62500
Plate Current	1250	1600
Grid Voltage (Approx.) for plate current of 10 μ a	0.5	1.2

Maximum Circuit Values:

Grid-Circuit Resistance:	Unit No.1	Unit No.2
For fixed-bias operation	15 max	0.5 max
For cathode-bias operation	—	1 max

Hum Output Voltage:

- Average Value (rms, cathode bypassed) 1.8 μ volts
- Maximum Value (rms, cathode unbypassed) 7 μ volts
- The dc component must not exceed 100 volts.
- Measured in "true rms" units under the following conditions: heater volts (ac), 6.3 (parallel connection); center tap of heater transformer connected to ground; dc plate supply volts, 250; plate load resistor, 0.1 megohm; cathode resistor, 2700 ohms; cathode-bypass capacitor, 100 μ f; grid resistor, 0 ohms; amplifier covering frequency range of 23 to 10000 cps.
- Same conditions as above, except that cathode resistor is unbypassed and grid resistor is 0.05 megohm.

POWER PENTODE

Glass octal type used in the power-output stage of high-fidelity audio-frequency amplifier systems. Outline 14E, OUTLINES SECTION. Tube requires octal socket and may be mounted in any position. Heater volts (ac/dc), 6.3; amperes, 0.8.

7355

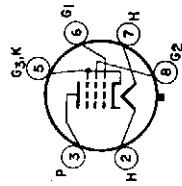

CLASS A₁ AMPLIFIER

Maximum Ratings, (Design-Maximum Values):

PLATE VOLTAGE.....	500 max	volts
GRID-NO.2 (SCREEN-GRID) VOLTAGE.....	400 max	volts
GRID-NO.1 (CONTROL-GRID) VOLTAGE, Positive-bias value.....	0 max	volts
PLATE DISSIPATION.....	18 max	watts
DC GRID-NO.2 INPUT.....	3.5 max	watts
AVERAGE CATHODE CURRENT.....	100 max	ma
PEAK HEATER-CATHODE VOLTAGE: Heater negative with respect to cathode.....	200 max	volts
Heater positive with respect to cathode.....	200 max	volts

Typical Operation and Characteristics:

Plate Voltage.....	250	volts
Grid-No.2 Voltage.....	225	volts
Grid-No.1 Voltage.....	-15	volts
Peak AF Grid-No.1 Voltage.....	15	volts
Plate Resistance (Approx.).....	42000	ohms
Transconductance.....	7600	μ mhos
Zero-Signal Plate Current.....	62	ma
Maximum Signal Plate Current.....	74	ma
Zero-Signal Grid-No.2 Current.....	3.2	ma
Maximum-Signal Grid-No.2 Current.....	16.5	ma
Maximum-Signal Plate Current.....	2500	ohms
Total Harmonic Distortion (Approx.).....	15	per cent
Maximum-Signal Power Output.....	9	watts
Grid-No.1 Voltage (Approx.) for plate current of 500 μ a.....	-85	volts

Maximum Circuit Values:

Grid-No.1-Circuit Resistance: For fixed-bias operation.....	0.3 max	megohm
For cathode-bias operation.....	1 max	megohm

PUSH-PULL CLASS AB₁ AMPLIFIER

Maximum Ratings, (Same as for Class A₁ amplifier):

Typical Operation (Values are for two tubes):		
Plate Voltage.....	300	volts
Grid-No.2 Voltage.....	250	volts
Grid-No.1 Voltage.....	-21	volts
Peak AF Grid-No.1 Voltage.....	42	volts
Zero-Signal Plate Current.....	100	ma
Maximum-Signal Plate Current.....	185	ma
Zero-Signal Grid-No.2 Current.....	5.5	ma
Maximum-Signal Grid-No.2 Current.....	24	ma
Effective Load Resistance (Plate-to-plate).....	4000	ohms
Total Harmonic Distortion.....	2	per cent
Maximum-Signal Power Output.....	28.5	watts
Grid-No.2 input may reach 7 watts during peak levels of speech and music signals.		
The dc component must not exceed 100 volts.		

BEAM POWER TUBE

Glass octal type used as output amplifier tube in high-quality sound systems. Outline 14C, OUTLINES SECTION. Tube requires octal socket and may be mounted in any position. Heater volts (ac/dc), 6.3; amperes, 0.45.

7408

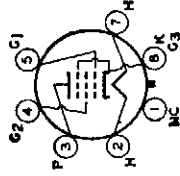

CLASS A₁ AMPLIFIER

Maximum Ratings, (Design-Maximum Values):

PLATE VOLTAGE.....	350 max	volts
GRID-NO.2 (SCREEN-GRID) VOLTAGE.....	315 max	volts
GRID-NO.2 INPUT.....	2.2 max	watts
PLATE DISSIPATION.....	14 max	watts
PEAK HEATER-CATHODE VOLTAGE: Heater negative with respect to cathode.....	200 max	volts
Heater positive with respect to cathode.....	200 max	volts

Typical Operation and Characteristics:

Plate Voltage.....	60	volts
Grid-No.2 Voltage.....	250	volts
Grid-No.1 (Control-Grid) Voltage.....	0	volts
Peak AF Grid-No.1 Voltage.....	-12.5	volts
Zero-Signal Plate Current.....	12.5	ma
Maximum-Signal Plate Current.....	100	ma
Zero-Signal Grid-No.2 Current.....	47	ma
Maximum-Signal Grid-No.2 Current.....	22	ma
Plate Resistance (Approx.).....	50000	ohms
Transconductance.....	4100	μ mhos
Load Resistance.....	5000	ohms
Total Harmonic Distortion.....	7	per cent
Maximum-Signal Power Output.....	4.5	watts

Maximum Circuit Values:

Grid-No.1 Circuit Resistance: For fixed-bias operation.....	0.1 max	megohm
For cathode-bias operation.....	0.5 max	megohm
The dc component must not exceed 100 volts.		
This value can be measured by a method involving a recurrent waveform such that the maximum ratings of the tube will not be exceeded.		

SHARP-CUTOFF PENTODE

Miniature type used in compact audio equipment, especially in low-hum, low-microphonic, high-gain, resistance-coupled-amplifier applications. Outline 7B, OUTLINES SECTION. This type is identical with miniature type 6AU6 except that it has a controlled hum characteristic.

7543

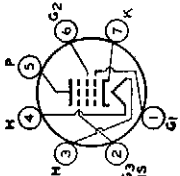

Hum Output Voltage:

- Average Value (rms, cathode bypassed) 1.21 millivolts
- Average Value (rms, cathode unbypassed) 0.9 millivolts
- Measured in "true rms" units under the following conditions: heater volts (ac), 6.3; center tap of heater transformer connected to ground; plate and grid-No.2 supply volts, 250; plate load resistor, 0.27 megohm; grid No.3 and internal shield connected to cathode at socket; grid-No.2 resistor, 0.68 megohm; grid-No.1 resistor, 0.1 megohm; cathode resistor, 1000 ohms; grid resistor of following stage, 10 megohms; and stage gain, 340
- Same conditions as above except cathode resistor is unbypassed and stage gain is 110.

7591

POWER PENTODE

Glass octal type used as audio-frequency power-output tube in high-quality audio applications. Outline 14C, OUTLINES SECTION. Tube requires octal socket and may be mounted in any position. Heater volts (ac/dc), 6.3; amperes, 0.8.

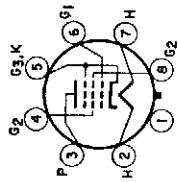

CLASS A₁ AMPLIFIER

Maximum Ratings, (Design-Maximum Values):

PLATE VOLTAGE.....	550 maz	volts
GRID-NO.2 (SCREEN-GRID) VOLTAGE.....	440 maz	volts
CATHODE CURRENT.....	85 maz	ma
PLATE DISSIPATION.....	19 maz	watts
GRID-NO.2 INPUT.....	3.3 ^{ma} maz	watts
PEAK HEATER-CATHODE VOLTAGE: Heater negative with respect to cathode.....	200 maz	volts
Heater positive with respect to cathode.....	200 ^{ma} maz	volts

Typical Operation and Characteristics:

Plate Voltage.....	300	volts
Grid-No.2 Voltage.....	300	volts
Grid-No.1 (Control-Grid) Voltage.....	-10	volts
Peak AF Grid-No.1 Voltage.....	10	volts
Zero-Signal Plate Current.....	60	ma
Maximum-Signal Plate Current.....	75	ma
Zero-Signal Grid-No.2 Current.....	8	ma
Maximum-Signal Grid-No.2 Current.....	15	ma
Triode Amplification Factor*	16.8	
Plate Resistance (Approx.).....	29000	ohms
Transconductance.....	10200	μmhos
Load Resistance.....	13	ohms
Total Harmonic Distortion.....	11	per cent
Maximum-Signal Power Output.....	11	watts

Maximum Circuit Values:

Grid-No.1-Circuit Resistance: For fixed-bias operation.....	0.3 maz	megohms
For cathode-bias operation.....	1 maz	megohm

PUSH-PULL CLASS AB₁ AMPLIFIER

(Same as for Class A₁ Amplifier)

Maximum Ratings, (Values are for two tubes):

Plate Supply Voltage.....	350	450	Fixed Bias
Grid-No.2 Supply Voltage.....	350	400	
Grid-No.1 Supply Voltage.....	-15.5	-21	Cathode Bias
Cathode-Bias Resistor (Common to both cathodes).....	31	42	200
Peak AF Grid-No.1-to-Grid-No.1 Voltage.....	92	66	
Maximum-Signal Plate Current.....	130	144	
Zero-Signal Grid-No.2 Current.....	13	9.4	
Maximum-Signal Grid-No.2 Current.....	28.5	30	
Effective Load Resistance (Plate-to-plate).....	6600	6600	
Total Harmonic Distortion.....	2	1.5	
Maximum-Signal Power Output.....	80	45	

• Grid-No.2 input may reach 6 watts during peak levels of speech and music signals.
 ■ The dc component must not exceed 100 volts.
 * Triode connection, grid No.2 connected to plate.

BEAM POWER TUBE

Neonaval type used as af power-amplifier tube. Outline 11C, OUTLINES SECTION. Tube requires neonaval nine-contact socket and may be mounted in any position. Heater volts (ac/dc), 50 volts; amperes, 0.15.

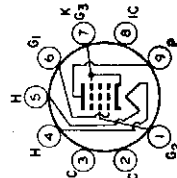

7695

Maximum Ratings, (Design-Maximum Values):

PLATE VOLTAGE.....	150 maz	volts
GRID-NO.2 (SCREEN-GRID) VOLTAGE.....	150 maz	volts
GRID-NO.2 INPUT.....	2.5 maz	watts
PLATE DISSIPATION.....	16 maz	watts
PEAK HEATER-CATHODE VOLTAGE: Heater negative with respect to cathode.....	200 maz	volts
Heater positive with respect to cathode.....	200 ^{ma} maz	volts

Typical Operation and Characteristics:

Plate Supply Voltage.....	130	Fixed Bias
Grid-No.2 Supply Voltage.....	130	Bias
Grid-No.1 (Control-Grid) Voltage.....	-11	
Cathode-Bias Resistor.....	11	
Peak AF Grid-No.1 Voltage.....	11	
Zero-Signal Plate Current.....	100	ma
Maximum-Signal Plate Current.....	108	ma
Zero-Signal Grid-No.2 Current.....	5	ma
Maximum-Signal Grid-No.2 Current.....	15	ma
Plate Resistance (Approx.).....	7000	ohms
Transconductance.....	11000	μmhos
Load Resistance.....	1100	ohms
Total Harmonic Distortion.....	11	per cent
Maximum-Signal Power Output.....	4.5	watts

Maximum Circuit Values:

Grid-No.1-Circuit Resistance: For fixed-bias operation.....	0.1 maz	megohm
For cathode-bias operation.....	0.5 maz	megohm
■ The dc component must not exceed 100 volts.		

PUSH-PULL CLASS AB₁ AMPLIFIER

(Same as for Class A₁ Amplifier)

Maximum Ratings, (Values are for two tubes):

Plate Supply Voltage.....	130	Fixed Bias
Grid-No.2 Supply Voltage.....	130	Bias
Grid-No.1 Voltage.....	-12	
Cathode-Bias Resistor.....	50	
Peak AF Grid-No.1-to-Grid-No.1 Voltage.....	22.6	
Zero-Signal Plate Current.....	195	ma
Maximum-Signal Plate Current.....	220	ma
Zero-Signal Grid-No.2 Current.....	9	ma
Maximum-Signal Grid-No.2 Current.....	24	ma
Effective Load Resistance (Plate-to-plate).....	1800	ohms
Total Harmonic Distortion.....	6	per cent
Maximum-Signal Power Output.....	10	watts

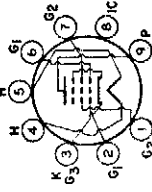

POWER PENTODE

Novar type used in output stages of high-fidelity audio amplifiers or radio receivers; used in applications requiring relatively large power output. Outline 10C, OUTLINES SECTION.

Tube requires novar nine-contact socket and may be operated in any position. It is especially important that this tube, like other power-handling tubes, be adequately ventilated.

Maximum Ratings, (Values are for two tubes):

HEATER VOLTAGE (AC/DC).....	6.3	volts
HEATER CURRENT.....	0.8	ampere
DIRECT INTERELECTRODE CAPACITANCES (Approx.):		
Grid No.1 to Plate.....	0.15	pf
Grid No.1 to Cathode, Heater, Grid No.2, and Grid No.3.....	11	pf
Plate to Cathode, Heater, Grid No.2, and Grid No.3.....	4.4	pf

7868

or heater of the tube at its operating temperature during the short-circuit test, because short-circuits in a tube may sometimes occur only when the electrodes are heated. However, a short-circuit tester having too high a sensitivity may indicate very-high-resistance shorts that do not adversely affect tube operation.

Selection of a Suitable Characteristic for Test

Some characteristics of a tube are far more important in determining its operating worth than are others. The cost of building a device to measure any one of the more important characteristics may be considerably higher than that of a device which measures a less representative characteristic. Consequently, three methods of test will be discussed, ranging from relatively simple and inexpensive equipment to more elaborate, more accurate, and more costly devices.

An emission test is perhaps the simplest method of indicating a tube's condition. (Refer to *Diodes, in ELECTRON TUBES, ELECTRODES, AND ELECTRON TUBES SECTION*, for a discussion of electron emission.) Since emission falls off as the tube wears out, low emission is indicative of the end of tube serviceability. However, the emission test is subject to limitations because it tests the tube under static conditions and does not take into account the actual operation of the tube. On the one hand, coated filaments, or cathodes, often develop active spots from which the emission is so great that the relatively small grid area adjacent to these spots cannot control the electron stream. Under these conditions, the total emission may indicate the tube to be normal although the tube is unsatisfactory. On the other hand, coated types of filaments are capable of such large emission that the tube will often operate satisfactorily after the emission has fallen far below the original value.

Fig. 100 shows the fundamental circuit diagram for an emission test. All of the electrodes of the tube, except the cathode, are connected to the plate. The filament, or heater, is operated at rated voltage; after the tube has reached con-

stant temperature, a low positive voltage is applied to the plate and the electron emission is read on the meter. Readings which are well below the average for a particular tube type indicate that the total number of available electrons has been so reduced that the tube is no longer able to function properly.

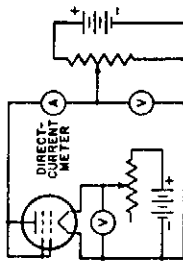

Fig. 100

A transconductance test takes into account a fundamental operating principle of the tube. (This fact will be seen from the definition of transconductance in the Section on *ELECTRON TUBE CHARACTERISTICS*.) It follows that transconductance tests, when properly made, permit better correlation between test results and actual performance than does a straight emission test.

There are two forms of transconductance test which can be utilized in a tube tester. In the first form (illustrated by Fig. 100 giving a fundamental circuit with a tetrode under test), appropriate operating voltages are applied to the

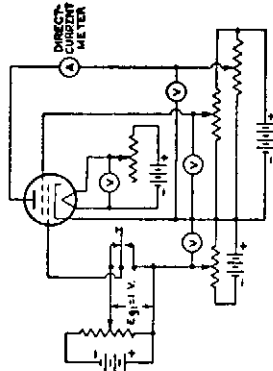

Fig. 101

electrodes of the tube. A plate current depending upon the electrode voltages will then be indicated by the meter. If the bias on the grid is then shifted by the application of a different grid voltage, a new plate-current reading is obtained. The difference between the two plate-current readings is indicative of the transconductance of the tube. This

method of transconductance testing is commonly called the "grid-shift" method, and depends on readings under static conditions. The fact that this form of test is made under static conditions imposes limitations not encountered in the second form of test made under dynamic conditions.

The dynamic transconductance test illustrated in Fig. 102 gives a fundamental circuit with a tetrode under test. This method is superior to the static transconductance test in that ac voltage is applied to the grid. Thus, the tube is tested under conditions which approximate actual operating conditions. The alternating component of the plate current is read by means of an ac ammeter of the dynamometer type. The transconductance of the tube is equal to the

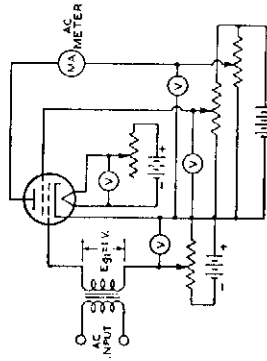

Fig. 102

ac plate current divided by the input-signal voltage. If a one-volt rms signal is applied to the grid, the plate-current-meter reading in milliamperes multiplied by one thousand is the value of transconductance in micromhos.

The power-output test probably gives the best correlation between test results and actual operating performance of a tube. In the case of voltage amplifiers, the power output is indicative of the amplification and output voltages obtainable from the tube. In the case of power-output tubes, the performance of the tube is closely checked. Consequently, although more complicated to set up, the power-output test will give closer correlation with actual performance than any other single test.

Fig. 103 shows the fundamental circuit of a power-output test for class A operation of tubes. The diagram illustrates the method for a pentode. The ac output voltage developed across the

plate-load impedance (L) is indicated by the current meter. The current meter is isolated as far as the dc plate current is concerned by the capacitor (C). The power output can be calculated from the

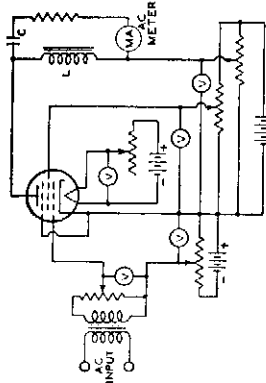

Fig. 103

current reading and known load resistance. In this way, it is possible to determine the operating condition of the tube quite accurately.

Fig. 104 shows the fundamental circuit of a power-output test for class B operation of tubes. With ac voltage applied to the grid of the tube, the current in the plate circuit is read on a dc milliammeter. The power output of the tube is approximately equal to:

$$(I_b^2 \times R_L) / 0.405,$$

where P_o is the power output in watts, I_b is the dc current in amperes, and R_L is the load resistance in ohms.

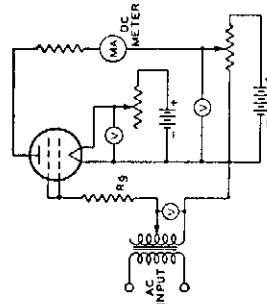

Fig. 104

Essential Tube-Tester Requirements

1. The tester should provide for making a short-circuit test before measurement of the tube's characteristics.
2. It is important that some means of controlling the voltages applied to the electrodes of the tube be provided. If the tester is ac operated, a line-voltage con-

trode voltages.

3. It is essential that the rated voltage applied to the filament or heater be maintained accurately.

4. It is suggested that the characteristics test follow one of the methods described. The method selected and the quality of the parts used in the test will depend upon the user's requirements.

Tube-Tester Limitations

A tube-testing device can only indicate the difference between a given tube's

characteristics and those which are standard for that particular type. Since the operating conditions imposed upon a tube of a given type may vary within wide limits, it is impossible for a tube-testing device to evaluate tubes in terms of performance capabilities for all applications. The tube tester, therefore, cannot be looked upon as a final authority in determining whether or not a tube is always satisfactory. Actual operating test in the equipment in which the tube is to be used will give the best possible indication of a tube's worth.

Resistance-Coupled Amplifiers

Resistance-coupled, audio-frequency voltage amplifiers utilize simple components and are capable of providing essentially uniform amplification over a relatively wide frequency range.

Suitable Tubes

In this section, data are given for over 50 types of tubes suitable for use in resistance-coupled circuits. These types include low- and high- μ triodes, twin triodes, triode-connected pentodes, and pentodes. The accompanying key to tube types will assist in locating the appropriate data chart.

Circuit Advantages

For most of the types shown, the data pertain to operation with cathode bias; for all of the pentodes, the data pertain to operation with series screen-grid resistor. The use of a cathode-bias resistor where feasible and a series screen-grid resistor where applicable offers several advantages over fixed-voltage operation.

The advantages are: (1) effects of possible tube differences are minimized; (2) operation over a wide range of plate-supply voltages without appreciable change in gain is feasible; (3) the low frequency at which the amplifier cuts off is easily changed; and (4) tendency toward motorboating is minimized.

Number of Stages

These advantages can be enhanced by the addition of suitable decoupling filters in the plate supply of each stage of a multi-stage amplifier. With proper filters, three or more amplifier stages can be operated from a single power-supply unit of conventional design without encountering any difficulties due to coupling

Type	Chart No.	Type	Chart No.
3AU6	2	6CG7	8
3AV6	9	6CN7	5
3BC5	11	6EU7	9
3CB6	10	6FQ7	8
3CF6	11	6J5	8
4AU6	2	6SL7GT	5
4BC5	11	6SN7GTB	8
4BQ7A	10	6T8A	5
4BZ7	10	7AU7	3
4CB6	11	8CG7	8
5BK7A	10	12AT6	5
5BQ7A	10	12AT7	4
5T8	5	12AU6	2
6AB4	4	12AU7A	3
6AG5	11	12AV6	9
6AT6	5	12AX7	9
6AU6A	2	12AX7A	9
6AV6	9	12AY7	1
6BC5	11	12SL7GT	5
6BK7B	10	12SN7GTA	8
6BQ7A	10	20EZ7	9
6BZ7	10	5879P	6
6C4	3	5879T	7
6CB6	11	7025	9
6CB6A	11	7199P	12
6CF6	11	7199T	13

T = Triode Unit or Triode Connection
 P = Pentode Unit or Pentode Connection

through the power unit. When decoupling filters are not used, not more than two stages should be operated from a single power-supply unit.

Symbols Used in Resistance-Coupled Amplifier Charts

- C = Blocking Capacitor (μf).
- C_k = Cathode Bypass Capacitor (μf).
- C_{g2} = Screen-Grid Bypass Capacitor (μf).
- E_{bb} = Plate-Supply Voltage (volts).

Voltage at plate equals plate-supply voltage minus drop in R_p and R_k .

- R_k = Cathode Resistor (ohms).
- R_{g2} = Screen-Grid Resistor (megohms).
- R_g = Grid Resistor (megohms) for following stage.
- R_p = Plate Resistor (megohms).
- V.G. = Voltage Gain.

E_o = Output Voltage (peak volts). This voltage is obtained across R_g (for following stage) at any frequency within the flat region of the output vs. frequency curve, and is for the condition where the signal level is adequate to swing the grid of the resistance-coupled amplifier tube to the point where its grid starts to draw current.

Note: The listed values for E_o are the peak output voltages available when the grid is driven from a low-impedance source. The listed values for the cathode resistors are optimum for any signal source. With a high-impedance source, protection against severe distortion and loss of gain due to input loading may be obtained by the use of a coupling capacitor connected directly to the input grid and a high-value resistor connected between the grid and ground.

General Circuit Considerations

In the discussions which follow, the frequency (f_1) is that value at which the high-frequency response begins to fall

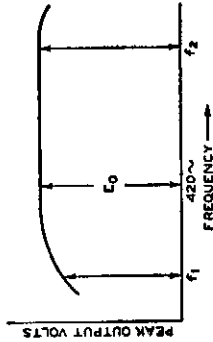

off. The frequency (f_1) is that value at which the low-frequency response drops below a satisfactory value, as discussed below. A variation of 10 per cent in values of resistors and capacitors has only slight effect on performance. One-half-watt resistors are usually suitable for R_{g2} , R_g , R_p , and R_k resistors. Capacitors C and C_{g2} should have a working voltage equal to or greater than E_{bb} . Capacitor C_k may have a low working voltage in the order of 10 to 25 volts.

Triode Amplifier Heater-Cathode Type

Capacitors C and C_k have been chosen to give an output voltage equal to 0.8 E_o for a frequency (f_1) of 100 cycles. For any other value of f_1 , multiply values of C and C_k by 100/ f_1 . In the

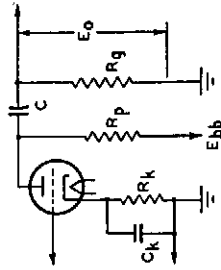

Diagram No. 1

case of capacitor C_k , the values shown in the charts are for an amplifier with dc heater excitation; when ac is used, depending on the character of the associated circuit, the gain, and the value of f_1 , it may be necessary to increase the value of C_k to minimize hum disturbances. It may be desirable to operate the heater at a positive voltage of from 15 to 40 volts with respect to the cathode. The voltage output at f_1 of "n" like stages equals $(0.8)^n \times E_o$, where E_o is the peak output voltage of final stage. For an amplifier of typical construction, the value of f_2 is well above the audio-frequency range for any value of R_p .

Pentode Amplifier Filament-Type

Capacitors C and C_{g2} have been chosen to give an output voltage equal to 0.8 $\times E_o$ for a frequency (f_1) of 100

cycles. For any other value of f_1 , multiply values of C and C_{g2} by 100/ f_1 . The voltage output at f_1 for "n" like stages equals $(0.8)^n \times E_o$, where E_o is peak output voltage of final stage. For an amplifier of typical construction, and for R_p values of 0.1, 0.25, and 0.5 megohm, approximate values of f_2 are 20000, 10000, and 5000 cps, respectively. Note: The

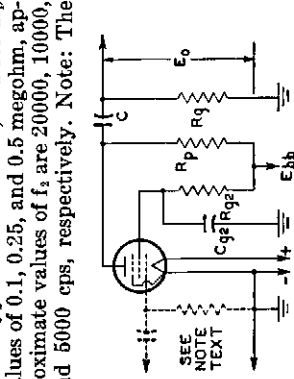

values of input-coupling capacitor in microfarads and of grid resistor in megohms should be such that their product lies between 0.02 and 0.1. Values commonly used are 0.005 μf and 10 megohms.

Pentode Amplifier Heater-Cathode Type

Capacitors C, C_k , and C_{g2} have been chosen to give an output voltage equal to $0.7 \times E_o$ for a frequency (f_1) of

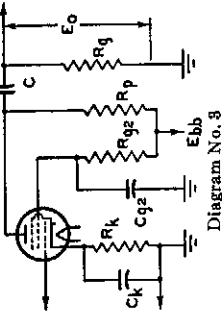

ac is used, depending on the character of the associated circuits, the voltage gain, and the value of f_1 , it may be necessary to increase the value of C_k to minimize hum disturbances. It may be desirable to operate the heater at a positive voltage of from 15 to 40 volts with respect to the cathode. The voltage output at f_1 for "n" like stages equals $(0.7)^n \times E_o$, where E_o is peak output voltage of final stage. For an amplifier of typical construction, and for R_p values of 0.1, 0.25, and 0.5 megohm, approximate values of f_2 are 20000, 10000, and 5000 cps, respectively.

(See page 492 for explanation of column headings)

E_{bb}	R_p	R_g	R_{g2}	R_k	C_{g2}	C_k	C	E_o^*	V.G.
90	0.1 0.24 0.51	0.24 0.51 1.0	-	1800 3700 7600	-	-	-	13 14 16	24 26 27
180	0.1 0.51	0.24 1.0	-	1300 2800 5700	-	-	-	31 33 33	27 29 30
300	0.1 0.51	0.24 1.0	-	1200 2300 4800	-	-	-	58 30 56	28 30 31

* One triode unit. * Peak volts.
† Coupling capacitors should be selected to give desired frequency response. Cathode resistors should be adequately bypassed.



12AY7
See Circuit Diagram 2

(See page 492 for explanation of column headings)

E _{bb}	R _p	R _g	R _{g2}	R _k	C _{g2}	C _k	C	E _o *	V.G.
90	0.22	0.22	0.340	2700	0.057	5.8	0.0081	16	79
	0.47	1.0	0.370	2900	0.050	5.4	0.0055	22	104
	0.47	1.0	0.380	3100	0.050	5.3	0.0034	25	125
	0.47	2.2	1.00	6000	0.027	2.8	0.0042	13	105
180	0.47	1.0	1.00	6200	0.023	2.7	0.0027	17	137
	0.47	2.2	1.00	6300	0.027	2.8	0.0019	25	161
	1.0	1.0	1.90	10800	0.017	1.7	0.0025	10	139
	1.0	2.2	2.40	13100	0.017	1.7	0.0017	19	184
300	0.22	0.22	0.520	1340	0.059	8.8	0.0081	31	143
	0.47	1.0	0.520	1390	0.059	8.7	0.0053	43	192
	0.47	1.0	0.520	1420	0.059	8.6	0.0032	48	223
	0.47	2.2	1.05	2700	0.039	5.5	0.0041	34	189
180	0.47	1.0	1.15	2880	0.037	5.4	0.0027	43	249
	0.47	2.2	1.20	2960	0.036	5.4	0.0019	50	294
	1.0	1.0	2.40	5500	0.028	3.2	0.0023	33	230
	1.0	2.2	2.70	6000	0.022	2.8	0.0015	40	323
300	0.22	0.22	0.530	780	0.077	13.2	0.0082	53	200
	0.47	1.0	0.540	783	0.077	13.2	0.0053	65	270
	0.47	1.0	0.540	800	0.077	13.1	0.0033	74	316
	0.47	2.2	1.15	1590	0.057	8.4	0.0045	56	275
300	0.47	1.0	1.22	1650	0.049	7.4	0.0027	72	357
	0.47	2.2	1.31	1720	0.045	7.2	0.0017	82	418
	1.0	1.0	2.50	3300	0.036	5.3	0.0022	57	352
	1.0	2.2	2.80	3500	0.031	4.2	0.0015	72	466

2

3AU6
4AU6
6AU6A
12AU6

See Circuit
Diagram 3

4

6AB4
12AT7*

See Circuit
Diagram 1

(See page 492 for explanation of column headings)

E _{bb}	R _p	R _g	R _{g2}	R _k	C _{g2}	C _k	C	E _o *	V.G.
90	0.1	0.1	-	2680	-	2.4	0.026	8	24
	0.22	0.47	-	3060	-	2.00	0.014	11	25
	0.22	1.0	-	3390	-	1.84	0.0074	13	28
	0.22	0.47	-	5500	-	1.33	0.0136	10	25
180	0.47	1.0	-	6300	-	1.01	0.0067	14	28
	0.47	2.2	-	6930	-	0.92	0.0038	15	28
	0.47	1.0	-	10900	-	0.63	0.007	13	26
	0.47	2.2	-	12500	-	0.52	0.0043	14	28
300	0.1	0.1	-	1407	-	3.6	0.029	20	31
	0.22	0.47	-	1674	-	3.0	0.016	28	33
	0.47	1.0	-	1786	-	2.6	0.0083	31	34
	0.22	0.47	-	2890	-	1.75	0.0140	24	33
180	0.22	1.0	-	3860	-	1.34	0.0077	35	33
	0.47	2.2	-	4660	-	1.14	0.0047	42	33
	0.47	1.0	-	6960	-	0.83	0.0075	31	31
	0.47	2.2	-	8450	-	0.67	0.0046	39	32
300	0.1	0.1	-	9600	-	0.55	0.0032	45	32
	0.22	0.47	-	974	-	4.0	0.028	37	34
	0.47	1.0	-	1404	-	3.1	0.015	57	34
	0.47	2.2	-	2169	-	2.5	0.0083	78	33
300	0.22	0.47	-	2510	-	1.9	0.015	50	33
	0.47	1.0	-	4200	-	1.3	0.0074	78	33
	0.47	2.2	-	4950	-	1.1	0.0046	85	32
	0.47	1.0	-	5700	-	0.90	0.0076	57	33
180	0.47	2.2	-	8720	-	0.62	0.0041	81	32
	0.47	1.0	-	9700	-	0.57	0.0030	88	32

3

6C4
7AU7*
12AU7A*

See Circuit
Diagram 1

E _{bb}	R _p	R _g	R _{g2}	R _k	C _{g2}	C _k	C	E _o *	V.G.
90	0.1	0.1	-	4200	-	2.5	0.025	5.4	22
	0.22	0.47	-	4600	-	2.0	0.014	7.5	30
	0.22	1.0	-	7000	-	1.5	0.013	7.3	30
	0.47	2.2	-	8100	-	1.3	0.007	10	34
180	0.47	1.0	-	12000	-	0.83	0.006	10	36
	0.47	2.2	-	14000	-	0.7	0.0035	14	39
	0.1	0.1	-	1900	-	3.6	0.027	19	30
	0.22	0.47	-	2200	-	3.1	0.014	25	35
300	0.1	0.1	-	2500	-	2.8	0.0065	32	37
	0.22	0.47	-	3400	-	2.2	0.014	24	38
	0.47	1.0	-	4100	-	1.7	0.0065	34	42
	0.47	2.2	-	4600	-	1.5	0.0035	38	44
180	0.47	1.0	-	6600	-	1.1	0.0065	29	44
	0.47	2.2	-	8100	-	0.9	0.0035	38	46
	0.1	0.1	-	9100	-	0.8	0.002	43	47
	0.22	0.47	-	1500	-	4.4	0.027	40	34
300	0.1	0.1	-	1800	-	3.6	0.014	54	38
	0.22	0.47	-	2100	-	3.0	0.0065	63	41
	0.22	0.47	-	2600	-	2.5	0.013	51	42
	0.47	1.0	-	3200	-	1.9	0.0065	65	46
180	0.47	2.2	-	3700	-	1.6	0.0035	77	48
	0.47	1.0	-	5200	-	1.2	0.006	61	48
	0.47	2.2	-	6300	-	1.0	0.0035	74	50
	0.47	1.0	-	7200	-	0.9	0.002	85	51

*Peak volts.

*Peak volts.

(See page 492 for explanation of column headings)

Ebb	R _p	R _g	R _{g2}	R _k	C _{g2}	C _k	C	E _o *	V.G.
90	0.1	0.1	0.35	1700	0.044	4.6	0.020	13	29
	0.22	0.47	0.80	3000	0.046	4.5	0.012	17	39
	0.47	1.0	1.9	7000	0.047	4.4	0.006	20	47
180	0.1	0.22	0.35	700	0.034	3.2	0.010	15	43
	0.22	0.47	0.80	3000	0.035	3.1	0.005	21	59
	0.47	1.0	1.9	7000	0.036	3.0	0.003	24	67
300	0.1	0.22	0.35	700	0.021	1.8	0.005	21	59
	0.22	0.47	0.80	3000	0.022	1.7	0.003	25	75
	0.47	1.0	1.9	7000	0.023	1.7	0.002	28	87
90	0.1	0.22	0.35	1700	0.060	7.4	0.020	24	39
	0.22	0.47	0.80	3000	0.062	7.3	0.012	28	56
	0.47	1.0	1.9	7000	0.064	7.2	0.006	33	65
180	0.1	0.22	0.35	700	0.045	5.5	0.010	24	65
	0.22	0.47	0.80	3000	0.046	5.3	0.005	31	87
	0.47	1.0	1.9	7000	0.048	5.2	0.003	34	101
300	0.1	0.22	0.35	700	0.033	3.5	0.005	27	98
	0.22	0.47	0.80	3000	0.034	3.4	0.003	32	122
	0.47	1.0	1.9	7000	0.035	3.3	0.002	37	140
90	0.1	0.22	0.35	1700	0.075	10.8	0.020	25	51
	0.22	0.47	0.80	3000	0.077	10.6	0.012	32	68
	0.47	1.0	1.9	7000	0.080	10.5	0.006	35	83
180	0.1	0.22	0.35	700	0.056	7.9	0.010	28	81
	0.22	0.47	0.80	3000	0.057	7.5	0.005	37	109
	0.47	1.0	1.9	7000	0.058	7.4	0.003	41	123
300	0.1	0.22	0.35	700	0.044	5.3	0.005	34	125
	0.22	0.47	0.80	3000	0.046	5.2	0.003	42	152
	0.47	1.0	1.9	7000	0.047	5.1	0.002	48	174

6

5879

See Circuit Diagram 3

7

As Triode:
5879

See Circuit Diagram 1

* Peak volts.

(See page 492 for explanation of column headings)

Ebb	R _p	R _g	R _{g2}	R _k	C _{g2}	C _k	C	E _o *	V.G.
90	0.047	0.047	-	1870	-	3.1	0.063	14	13
	0.1	0.22	-	2230	-	2.5	0.031	18	14
	0.47	1.0	-	2500	-	2.1	0.016	20	14
180	0.1	0.22	-	3370	-	1.8	0.034	15	14
	0.22	0.47	-	4100	-	1.3	0.015	20	14
	0.47	1.0	-	4800	-	1.1	0.006	23	15
300	0.1	0.22	-	7000	-	0.80	0.013	16	14
	0.22	0.47	-	9100	-	0.65	0.007	22	14
	0.47	1.0	-	10500	-	0.60	0.004	25	15
90	0.047	0.047	-	1500	-	3.6	0.066	33	14
	0.1	0.22	-	1860	-	2.9	0.055	41	14
	0.47	1.0	-	2160	-	2.2	0.015	47	15
180	0.1	0.22	-	2750	-	1.8	0.028	35	15
	0.22	0.47	-	3550	-	1.4	0.015	45	15
	0.47	1.0	-	4140	-	1.3	0.007	51	16
300	0.1	0.22	-	5150	-	1.0	0.016	36	16
	0.22	0.47	-	7000	-	0.71	0.007	45	16
	0.47	1.0	-	7800	-	0.61	0.004	51	16
90	0.047	0.047	-	1300	-	3.6	0.051	59	14
	0.1	0.22	-	1580	-	3.0	0.032	73	15
	0.47	1.0	-	1800	-	2.5	0.015	83	16
180	0.1	0.22	-	2500	-	1.9	0.031	68	16
	0.22	0.47	-	3130	-	1.4	0.014	82	16
	0.47	1.0	-	3900	-	1.2	0.0065	96	16
300	0.1	0.22	-	4800	-	0.95	0.015	68	16
	0.22	0.47	-	6500	-	0.69	0.0065	85	16
	0.47	1.0	-	7800	-	0.58	0.0035	96	16
90	0.1	0.22	-	4400	-	2.7	0.023	5	29
	0.22	0.47	-	4700	-	2.4	0.013	6	35
	0.47	1.0	-	4800	-	2.3	0.007	8	41
180	0.1	0.22	-	7000	-	1.6	0.012	6	39
	0.22	0.47	-	7400	-	1.4	0.006	9	45
	0.47	1.0	-	7600	-	1.3	0.003	11	48
300	0.1	0.22	-	12000	-	0.9	0.006	9	48
	0.22	0.47	-	13000	-	0.8	0.003	11	52
	0.47	1.0	-	14000	-	0.7	0.002	13	55
90	0.1	0.22	-	1800	-	4.0	0.025	18	40
	0.22	0.47	-	2200	-	3.5	0.013	25	47
	0.47	1.0	-	2200	-	3.1	0.006	32	52
180	0.1	0.22	-	3000	-	2.4	0.012	24	53
	0.22	0.47	-	3500	-	2.1	0.006	34	59
	0.47	1.0	-	3900	-	1.8	0.003	39	63
300	0.1	0.22	-	5800	-	1.3	0.006	30	62
	0.22	0.47	-	6700	-	1.1	0.003	39	66
	0.47	1.0	-	7400	-	1.0	0.002	45	68
90	0.1	0.22	-	1300	-	4.6	0.027	43	45
	0.22	0.47	-	1500	-	4.0	0.013	57	52
	0.47	1.0	-	1700	-	3.6	0.006	66	57
180	0.1	0.22	-	2200	-	3.0	0.013	54	59
	0.22	0.47	-	2800	-	2.3	0.006	69	65
	0.47	1.0	-	3100	-	2.1	0.003	79	68
300	0.1	0.22	-	4300	-	1.6	0.006	62	69
	0.22	0.47	-	5200	-	1.3	0.003	77	73
	0.47	1.0	-	5900	-	1.1	0.002	92	75

* One triode unit. * Peak volts.

8
6CG7*
6FQ7
6J5
6SN7GTB*
8CG7
12SN7GTA*

See Circuit Diagram 1

9

3AV6
6AV6
6EU7*
12AX7*
12AX7A*
20E7*
7025*

See Circuit Diagram 1

(See page 102 for explanation of column headings)

Ebb	R _p	R _g	R _{g2}	R _k	C _{g2}	C _k	C	E _o *	V.G.
90	0.047	0.047	-	1580	-	4.0	0.058	9	18
	0.10	0.10	-	1760	-	3.5	0.032	13	19
	0.22	0.22	-	1820	-	3.0	0.015	16	20
180	0.1	0.1	-	2920	-	2.1	0.029	12	19
	0.22	0.22	-	3570	-	1.7	0.015	17	20
	0.47	0.47	-	4020	-	1.4	0.0075	20	20
300	0.22	0.22	-	6040	-	0.98	0.0135	16	19
	0.47	0.47	-	7500	-	0.78	0.0075	21	20
	1.0	1.0	-	8800	-	0.63	0.0036	25	20
90	0.047	0.047	-	694	-	6.0	0.062	25	23
	0.1	0.1	-	817	-	4.4	0.032	32	24
	0.22	0.22	-	905	-	4.0	0.0155	35	25
180	0.1	0.1	-	1596	-	2.80	0.030	30	23
	0.22	0.22	-	1630	-	2.30	0.0152	32	24
	0.47	0.47	-	1860	-	2.00	0.0073	38	24
300	0.22	0.22	-	3950	-	1.24	0.0150	35	22
	0.47	0.47	-	4500	-	0.96	0.0072	41	23
	1.0	1.0	-	5530	-	0.79	0.0038	49	23
90	0.047	0.047	-	438	-	6.70	0.062	38	26
	0.1	0.1	-	542	-	5.50	0.032	48	27
	0.22	0.22	-	644	-	4.30	0.016	57	27
300	0.10	0.10	-	1009	-	3.5	0.031	42	25
	0.22	0.22	-	1332	-	2.5	0.015	56	26
	0.47	0.47	-	1609	-	2.1	0.0074	64	25
90	0.22	0.22	-	2623	-	1.5	0.015	50	24
	0.47	0.47	-	3900	-	1.1	0.0073	70	24
	1.0	1.0	-	4920	-	0.88	0.0039	84	24

10

- 4BQ7A*
- 4BZ7*
- 5BK7A*
- 5BQ7A*
- 6BK7B*
- 6BQ7A*
- 6BZ7*

See Circuit Diagram 1

11

- 3BC5
- 3CB6
- 3CF6
- 4BC5
- 4CB6
- 6AG5
- 6BC5
- 6CB6
- 6CB6A
- 6CF6

See Circuit Diagram 3

* One triode unit. * Peak volts.

(See page 102 for explanation of column headings)

Ebb	R _p	R _g	R _{g2}	R _k	C _{g2}	C _k	C	E _o *	V.G.
90	0.22	0.22	0.560	3700	0.046	4.50	0.0090	12	73
	0.47	0.47	0.600	3900	0.043	4.00	0.0055	17	95
	1.0	1.0	0.650	4200	0.039	4.00	0.0033	19	109
180	0.47	0.47	0.870	6000	0.036	2.70	0.0046	16	95
	1.0	1.0	0.980	6700	0.044	3.00	0.0030	22	113
	2.2	2.2	1.00	6700	0.043	2.80	0.0020	25	131
300	1.0	1.0	2.00	12200	0.021	1.44	0.0028	15	119
	2.2	2.2	2.20	12800	0.024	1.74	0.0016	21	167
	2.2	2.2	0.530	1570	0.069	7.50	0.0088	32	82
90	0.22	0.22	0.600	1730	0.064	7.40	0.0064	38	164
	0.47	0.47	0.650	1820	0.061	7.30	0.0034	45	190
	1.0	1.0	1.12	3200	0.053	5.30	0.0046	35	147
180	0.47	0.47	1.40	3500	0.042	5.10	0.0028	40	209
	1.0	1.0	1.57	3740	0.040	5.40	0.0019	45	250
	2.2	2.2	2.50	6500	0.039	2.80	0.0024	34	179
300	1.0	1.0	3.40	7500	0.026	2.30	0.0015	39	277
	2.2	2.2	0.600	9200	0.086	11.2	0.0085	52	182
	2.2	2.2	0.670	1010	0.076	10.5	0.0052	66	236
90	0.22	0.22	0.720	1100	0.076	10.0	0.0033	77	257
	0.47	0.47	1.25	1950	0.060	7.0	0.0044	41	221
	1.0	1.0	1.43	3210	0.053	6.4	0.0027	72	296
180	0.47	0.47	1.45	2200	0.055	6.3	0.0019	82	345
	1.0	1.0	3.00	4100	0.040	4.2	0.0022	57	295
	2.2	2.2	3.30	4340	0.037	3.6	0.0016	74	378

12

7199

Pentode Unit

See Circuit Diagram 3

13

7199

Triode Unit

See Circuit Diagram 1

Ebb	R _p	R _g	R _{g2}	R _k	C _{g2}	C _k	C	E _o *	V.G.
90	0.047	0.047	-	1292	-	3.3	0.060	8	12
	0.10	0.10	-	1401	-	2.8	0.032	10	13
	0.22	0.22	-	1470	-	2.4	0.016	11	13
180	0.1	0.1	-	2630	-	1.60	0.029	9	13
	0.22	0.22	-	3090	-	1.24	0.015	12	13
	0.47	0.47	-	3440	-	1.10	0.008	14	14
300	0.22	0.22	-	6550	-	0.70	0.015	12	12
	0.47	0.47	-	8270	-	0.51	0.0077	16	12
	1.0	1.0	-	9130	-	0.44	0.0045	18	12
90	0.047	0.047	-	723	-	4.0	0.061	16	14
	0.1	0.1	-	836	-	3.5	0.032	20	14
	0.22	0.22	-	948	-	2.9	0.016	24	15
180	0.1	0.1	-	1543	-	2.0	0.031	17	14
	0.22	0.22	-	2002	-	1.6	0.016	24	14
	0.47	0.47	-	2522	-	1.2	0.0082	30	13
300	0.22	0.22	-	4390	-	0.79	0.015	24	13
	0.47	0.47	-	5122	-	0.57	0.0078	33	12
	1.0	1.0	-	8060	-	0.47	0.0046	41	12
90	0.047	0.047	-	534	-	4.0	0.061	27	15
	0.1	0.1	-	726	-	3.6	0.031	38	15
	0.22	0.22	-	840	-	3.0	0.015	44	15
180	0.1	0.1	-	1117	-	2.3	0.031	26	15
	0.22	0.22	-	1613	-	1.7	0.0155	41	14
	0.47	0.47	-	2043	-	1.31	0.0078	51	14
300	0.22	0.22	-	3133	-	0.93	0.015	36	13
	0.47	0.47	-	4480	-	0.69	0.0079	51	13
	1.0	1.0	-	4930	-	0.56	0.0045	55	13

* Peak volts.

Outlines

(All dimensions are in inches)

METAL TYPES

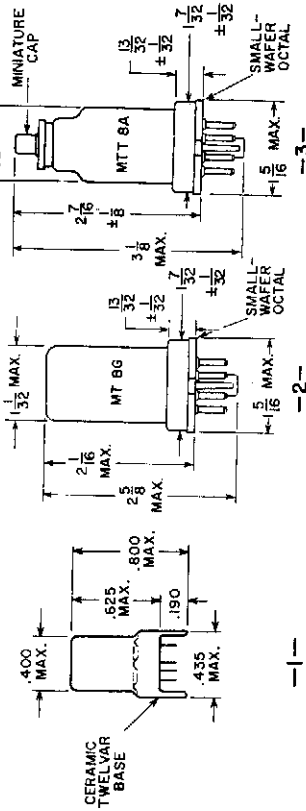

-1-

-2-

-3-

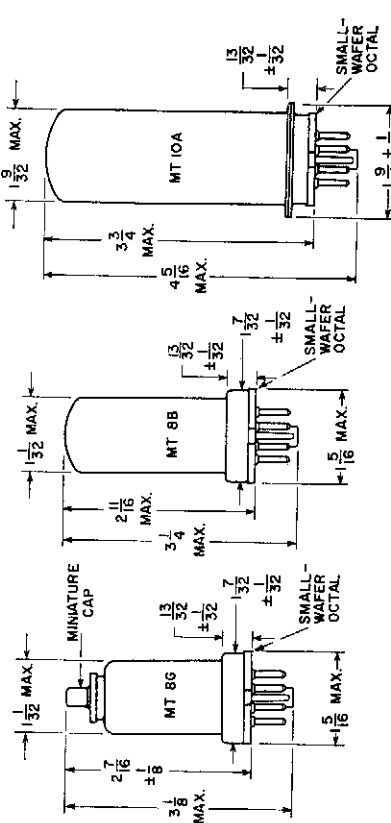

-4-

-5-

-6-

GLASS TYPES

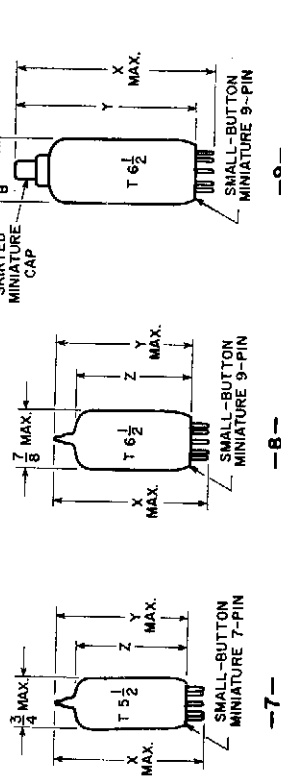

-7-

-8-

-9-

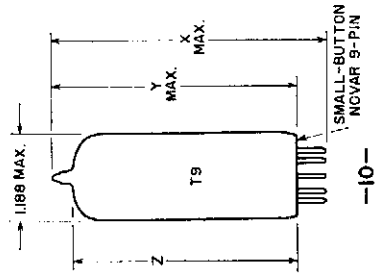

-10-

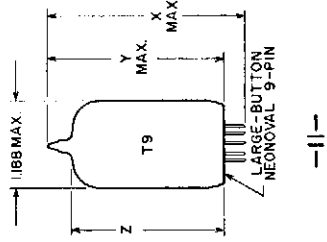

-11-

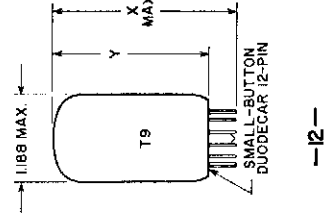

-12-

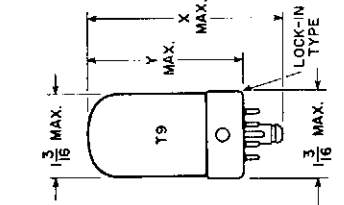

-13-

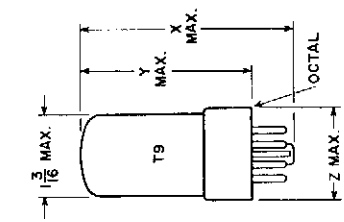

-14-

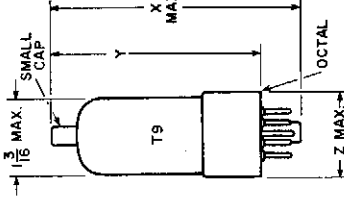

-15-

Outline X Y Z

10A	3.000	2.620	2.100-2.280
10B	3.080	2.700	2.050-2.230
10C	3.110	2.780	2.210-2.390
10D	3.410	3.030	2.510-2.690

Outline X Y Z

11A	2.630	2.320	1.770-2.010
11B	2.980	2.620	2.070-2.310
11C	3.280	2.920	2.370-2.610

Outline X Y

12A	1.875	1.250-1.500
12B	2.375	1.750-2.000
12C	2.625	2.000-2.250
12D	2.875	2.250-2.500

Outline X Y Z

13A	2-25/32	2-1/4	
13B	3-5/32	2-5/8	

Outline X Y Z

14A	2-7/8	2-5/16	1-9/32
14B	3	2-7/16	1-9/32
14C	3-5/16	2-3/4	1-5/16
14D	3-3/8	2-15/16	1-9/32
14E	3-7/16	2-7/8	1-9/32
14F	3-13/16	3-1/4	1-9/32

Outline X Y Z

15A	3-5/16	2-3/4	1-5/16
15B	3-9/16	3	1-9/32
15C	3-7/8	3-5/16	1-9/32
15D	4-1/16	3-1/2	1-9/32

Outline X Y Z

7A	1-9/4	1-1/2	1-1/8 ± 3/32
7B	2-1/8	1-7/8	1-1/2 ± 3/32
7C	2-5/8	2-3/8	2 ± 3/32
8A	1-3/4	1-1/2	1-1/8 ± 3/32
8B	2-3/16	1-15/16	1-9/16 ± 3/32
8C	2-13/32	2-5/32	1-25/32 ± 3/32
8D	2-5/8	2-8/8	2 ± 3/32
8E	3-1/16	2-19/16	2-7/16 ± 3/32
9A	2-9/32	2-7/16 ± 1/8	
9B	3-9/32	2-7/8 ± 1/8	
9C	3-1/2	3-1/4 min.	

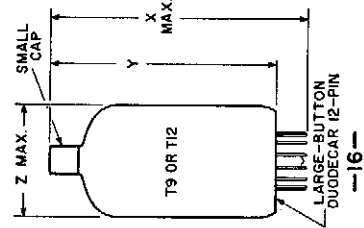

Outline X Y Z
 16A 3.375 2.750-3.000 1.188
 16B 3.625 3.000-3.250 1.188
 16C 3.625 3.000-3.250 1.583
 16D 4.125 3.500-3.750 1.583

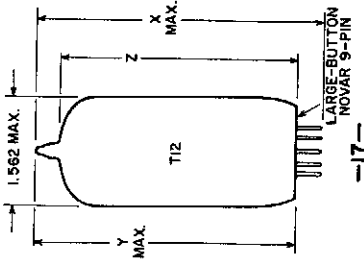

Outline X Y Z
 17A 3.410 3.030 2.510 ± 0.090
 17B 4.160 3.780 3.260 - 3.440

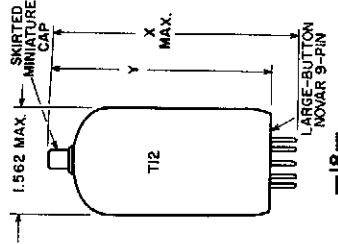

Outline X Y
 18A 3.55 3.04 ± 0.13
 18B 4.60 3.09 ± 0.13

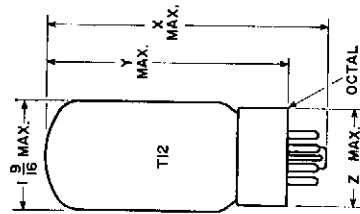

-19-

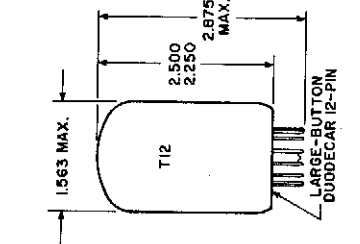

-20-

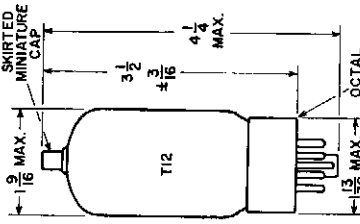

-21-

Outline X Y Z
 19A 3-7/8 3-5/16 1-13/32
 19B 4 3-7/16 1-13/32
 19C 4-1/4 3-11/16 1-3/8
 19D 4-5/8 4-1/16 1-3/8
 19E 4-3/4 4-3/16 1-11/16

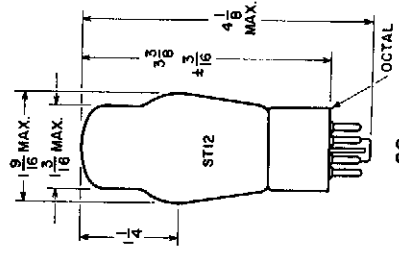

-22-

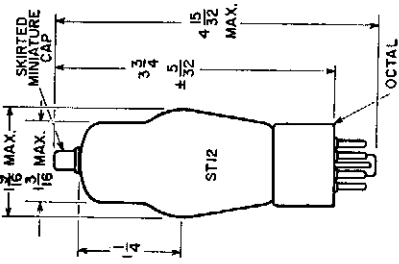

-23-

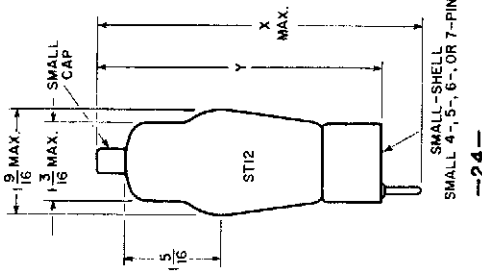

-24-

Outline X Y
 24A 4-15/16 4-3/16 ± 1/8
 24B 4-17/32 3-25/32 ± 1/8

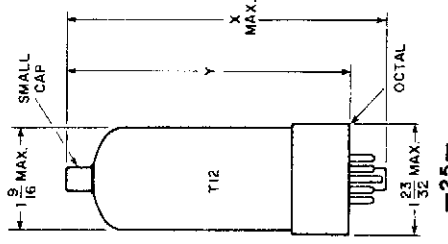

-25-

Outline X Y
 25A 5 4-7/16
 25B 5-7/32 4-1/4

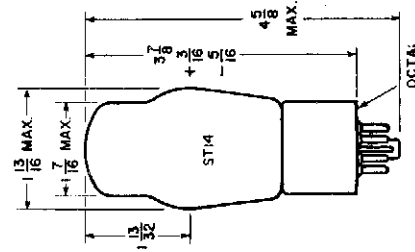

-26-

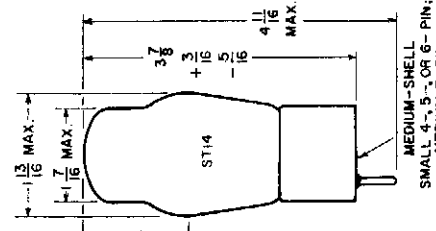

-27-

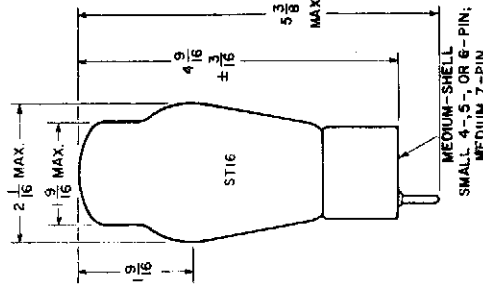

-28-

Circuits

The circuits included in this Manual illustrate some of the more important applications of RCA receiving tubes; they are not necessarily examples of commercial practice. These circuits have been conservatively designed and are capable of excellent performance. Electrical specifications are given for circuit components to assist those interested in home construction. Layouts and mechanical details are omitted because they vary widely with the requirements of individual set builders and with the sizes and shapes of the components employed.

Circuits designed for operation from both ac and dc voltage supplies should be installed in non-metallic cabinets or properly insulated from metallic cabinets. Potentiometer shafts and switches should make use of insulated (plastic) knobs. In practical use, no metallic part of an "ac/dc" chassis should be exposed to touch, accidental or otherwise. When such circuits are tested outside of their cabinets, a line isolation transformer such as the RCA WP-25A Isotap should be used.

Performance of these circuits depends as much on the quality of the components selected and the care employed in layout and construction as on the circuits themselves. Good signal reproduction from receivers and amplifiers requires the use of good-quality speakers, transformers, chokes, and input sources (microphones, phonograph pickups, etc.).

Coils for the receiver circuits may be purchased at local parts dealers by specifying the characteristics required: for rf coils, the circuit position (antenna or interstage), tuning range desired, and tuning capacitances employed; for if coils or transformers, the intermediate frequency, circuit position (1st if, 2nd if, etc.), and, in some cases, the associated tube types; for oscillator coils, the receiver tuning range, the intermediate frequency, the type of converter tube, and the type of winding

used (tapped or transformer-coupled). The voltage ratings specified for capacitors are the minimum dc working voltages required. Paper, mica, or ceramic capacitors having higher voltage ratings than those specified may be used except insofar as the physical sizes of such capacitors may affect equipment layout. However, if electrolytic capacitors having substantially higher voltage ratings than those specified are used, they may not "form" completely at the operating voltage, with the result that the effective capacitances of such units may be below their rated value. The wattage ratings specified for resistors assume methods of construction that provide adequate ventilation; compact installations having poor ventilation may require resistors of higher wattage ratings.

Circuits which work at very high frequencies or which are required to handle very wide bandwidths demand more than ordinary skill and experience in construction. Placement of component parts is quite critical and may require considerable experimentation. All rf leads to components including bypass capacitors must be kept short and must be properly dressed to minimize undesirable coupling and capacitance effects. Correct circuit alignment and oscillator tracking may require the use of a cathode-ray oscilloscope, a high-impedance vacuum-tube voltmeter, and a signal generator capable of supplying a properly modulated signal at the appropriate frequencies. Unless the builder has had considerable experience with broadband, high-frequency circuits, he should not undertake the construction of such circuits.

Information on the characteristics and application features of each tube type are given in the TECHNICAL DATA FOR RCA RECEIVING TUBES SECTION. This information should be helpful in the understanding and utilization of the circuits.

LIST OF CIRCUITS

	Page
22-1	506
22-2	507
22-3	508
22-4	509
22-5	510
22-6	511
22-7	512
22-8	514
22-9	515
22-10	516
22-11	517
22-12	518
22-13	519
22-14	520
22-15	521
22-16	522
22-17	523
22-18	524
22-19	524
22-20	525
22-21	526
22-22	526
22-23	527
22-24	527
22-25	528
22-26	528
22-27	529
22-28	529
22-29	530
22-30	531
22-31	532
22-32	534
22-33	535

(22-1)

PORTABLE BATTERY-OPERATED SUPERHETERODYNE RECEIVER

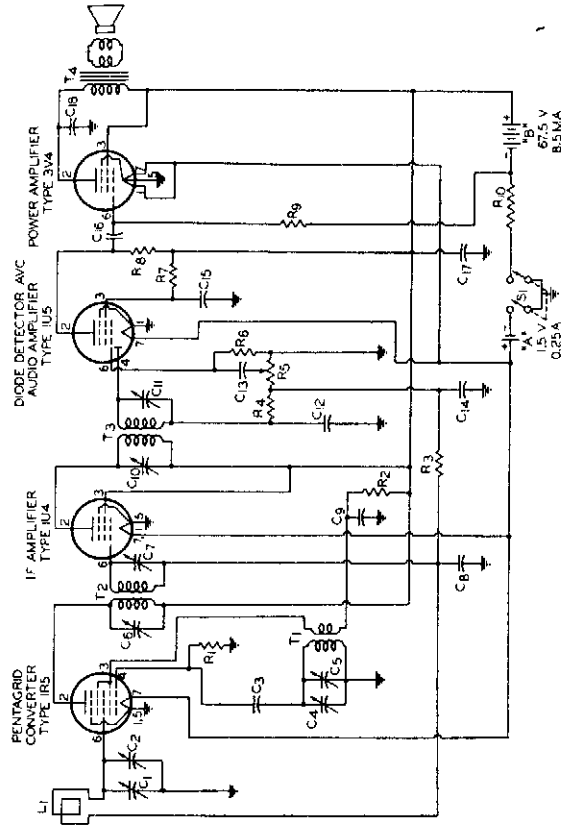

- C₁, C₂ = Ganged tuning capacitors, 7.5-122.5 pf.
- C₃ = 10-274 pf, C₄ = 430 pf
- C₅ = Trimmer capacitors, 2.5 pf, ceramic
- C₆, C₇, C₈ = Trimmer capacitors for IF transformers
- C₉ = 0.05 μf, paper, 50 v.
- C₁₀ = 0.02 μf, paper, 100 v.
- C₁₁ = 0.02 μf, ceramic
- C₁₂ = 0.002 μf, paper, 150 v.
- C₁₃ = 10 megohms, 0.25 watt
- C₁₄ = 10 μf, electrolytic, 100 v.
- C₁₅ = 20 μf, electrolytic, 100 v.
- L₁ = Loop antenna or ferrite-rod antenna, 540-1600 Kc (with specified values of capacitance for C₁ and C₂)
- R₁ = 0.1 megohm, 0.25 watt
- R₂ = 15000 ohms, 0.25 watt
- R₃ = 3.3 megohms, 0.25 watt
- R₄ = 55000 ohms, 0.25 watt
- R₅ = Volume control, potentiometer, 2 megohms
- R₆ = 10 megohms, 0.25 watt
- R₇ = 4.7 megohms, 0.25 watt
- R₈, R₉ = 1 megohm, 0.25 watt
- R₁₀ = 90 v.
- S₁ = Switch, double-pole, single-throw
- T₁ = Oscillator coil for use with tuning capacitor of transformers, 455 Kc (permeability-tuned type may be used)
- T₂ = Output transformer for matching impedance of voice coil to 10000-ohm tube load

(22-2)

PORTABLE 3-WAY SUPERHETERODYNE RECEIVER

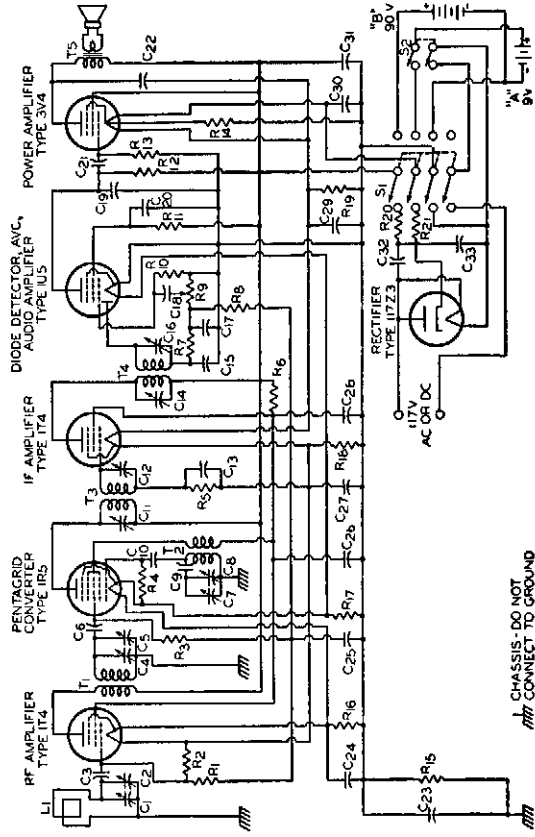

- C₁, C₂ = Ganged tuning capacitors, 20-450 pf
- C₃ = Trimmer capacitors, 430 pf
- C₄, C₅ = Trimmer capacitors, 2.5 pf, ceramic
- C₆ = 50 pf, ceramic
- C₇, C₈ = Trimmer capacitors for IF transformers
- C₉ = 0.05 μf, paper, 400 v.
- C₁₀ = 0.02 μf, paper, 400 v.
- C₁₁ = 0.02 μf, ceramic
- C₁₂ = 0.002 μf, paper, 400 v.
- C₁₃ = 0.1 μf, paper, 200 v.
- C₁₄ = 0.05 μf, paper, 50 v.
- C₁₅ = 10 μf, electrolytic, 25 v.
- C₁₆ = 10 μf, electrolytic, 25 v.
- C₁₇ = 1000 ohms, 0.25 watt
- C₁₈ = 20 μf, electrolytic, 100 v.
- C₁₉ = 1500 ohms, 0.25 watt
- R₁ = 1800 ohms, 10 watts
- R₂ = 2300 ohms, 10 watts
- S₁ = Switch, 4-pole double-throw
- S₂ = Switch, double-pole, single-throw
- T₁ = RF transformer, 540-1600 Kc
- T₂ = Oscillator coil for use with a 560-μf padder, 20-450 μf tuning capacitor, and 455 Kc if transformer
- T₃ = Intermediate-frequency transformers, 455 Kc (permeability-tuned type may be used)
- T₄ = Output transformer for matching impedance of voice coil to 10000-ohm tube load

(22-3)

AC-OPERATED SUPERHETERODYNE RECEIVER

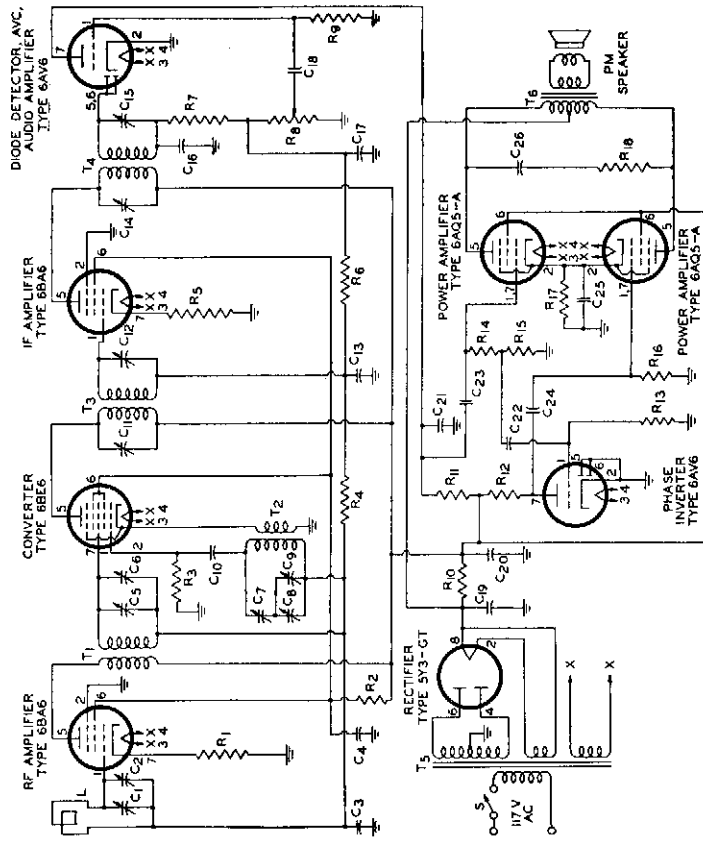

- C₁, C₂, C₃ = Ganged tuning capacitors, 10-365 pf
- C₄, C₅ = Trimmer capacitors, 4-30 pf
- C₆ = 0.05 μf, paper, 50 v.
- C₇ = 0.05 μf, paper, 400 v.
- C₈ = Oscillator padding capacitor—follow oscillator coil manufacturer's recommendation
- C₉ = 56 pf, mica
- C₁₀, C₁₁, C₁₂, C₁₃ = Trimmer capacitors for if transformers
- C₁₄, C₁₅ = 180 pf, mica
- C₁₆, C₁₇ = 20 μf, electrolytic, 450 v.
- C₁₈ = 20 μf, electrolytic, 450 v.
- C₁₉ = 80 μf, electrolytic, 0.5 watt
- C₂₀ = 120 pf, mica
- C₂₁, C₂₂ = 0.02 μf, paper, 400 v.
- C₂₃ = 20 μf, electrolytic, 50 v.
- C₂₄ = 0.05 μf, paper, 600 v.
- C₂₅ = Loop antenna or ferrite-rod antenna, 540-1600 Kc (with specified values of ca. 7-115 μf tuning capacitor and 455-Kc if transformer)
- C₂₆ = 10-365 μf tuning capacitor
- R₁, R₂ = 12000 ohms, 0.5 watt
- R₃ = 39000 ohms, 0.5 watt
- R₄, R₅ = 2.2 megohms, 0.5 watt
- R₆ = 1 megohm, 0.5 watt
- R₇ = 0.1 megohm, 0.5 watt
- R₈ = 15000 ohms, 1 watt
- R₉ = 15000 ohms, 1 watt
- R₁₀ = 10 megohms, 0.5 watt
- R₁₁ = 10 megohms, 0.5 watt
- R₁₂ = 10 megohms, 0.5 watt
- R₁₃ = 10 megohms, 0.5 watt
- R₁₄ = 10 megohms, 0.5 watt
- R₁₅ = 10 megohms, 0.5 watt
- R₁₆ = 10 megohms, 0.5 watt
- R₁₇ = 10 megohms, 0.5 watt
- R₁₈ = 10 megohms, 0.5 watt
- R₁₉ = 10 megohms, 0.5 watt
- R₂₀ = 10 megohms, 0.5 watt
- R₂₁ = 10 megohms, 0.5 watt
- R₂₂ = 10 megohms, 0.5 watt
- R₂₃ = 10 megohms, 0.5 watt
- R₂₄ = 10 megohms, 0.5 watt
- R₂₅ = 10 megohms, 0.5 watt
- R₂₆ = 10 megohms, 0.5 watt
- T₁ = RF transformer, 540-1600 Kc
- T₂ = Intermediate-frequency transformer, 455 Kc (permeability-tuned type may be used)
- T₃ = Volume control potentiometer, 250-0-250 volts rms, 120 ma, dc
- T₄ = Output transformer for matching impedance of voice coil to a 10000-ohm plate-to-plate tube load
- T₅ = 5Y3-GT rectifier

(22-4)

AC/DC SUPERHETERODYNE RECEIVER

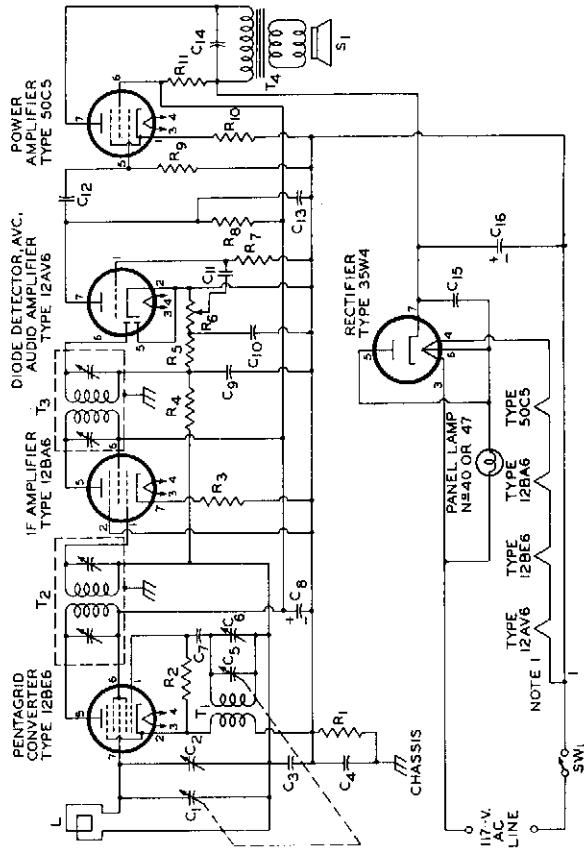

- C₁, C₂ = Ganged tuning capacitors: C₁, 10-365 pf; C₂, 7-115 pf
- C₃ = Trimmer capacitor, 4-30 pf
- C₄ = 0.05 μf, paper, 50 v.
- C₅ = 0.1 μf, paper, 400 v.
- C₆ = Trimmer capacitor, 2-17 pf
- C₇ = 56 pf, ceramic
- C₈ = 30 μf, electrolytic, 150 v.
- C₉, C₁₀ = 0.02 μf, paper, 400 v.
- C₁₁ = 80 μf, electrolytic, 0.5 watt
- C₁₂ = 80 μf, mica
- C₁₃ = 0.05 μf, paper, 400 v.
- C₁₄ = 50 μf, electrolytic, 150 v.
- C₁₅ = Loop antenna or ferrite-rod antenna, 540-1600 Kc (with specified values of ca. 7-115 μf tuning capacitor and 455-Kc intermediate-frequency transformer)
- C₁₆ = 10-365 μf tuning capacitor
- R₁, R₂ = 100 ohms, 0.5 watt
- R₃ = 33000 ohms, 0.5 watt
- R₄ = 3.3 megohms, 0.5 watt
- R₅ = 47000 ohms, 0.5 watt
- R₆ = Volume control potentiometer, 0.5 megohm, 0.5 watt
- R₇ = 4.7 megohms, 0.5 watt
- R₈, R₉ = 0.47 megohm, 0.5 watt
- R₁₀ = 15000 ohms, 0.5 watt
- R₁₁ = 12000 ohms, 1 watt
- T₁ = RF transformer, 540-1600 Kc
- T₂ = Intermediate-frequency transformer, 455 Kc (permeability-tuned type may be used)
- T₃ = Volume control potentiometer, 250-0-250 volts rms, 120 ma, dc
- T₄ = Output transformer for matching impedance of voice coil to a 10000-ohm plate-to-plate tube load
- T₅ = 5Y3-GT rectifier

(22-7)

CITIZENS-BAND TRANSCEIVER

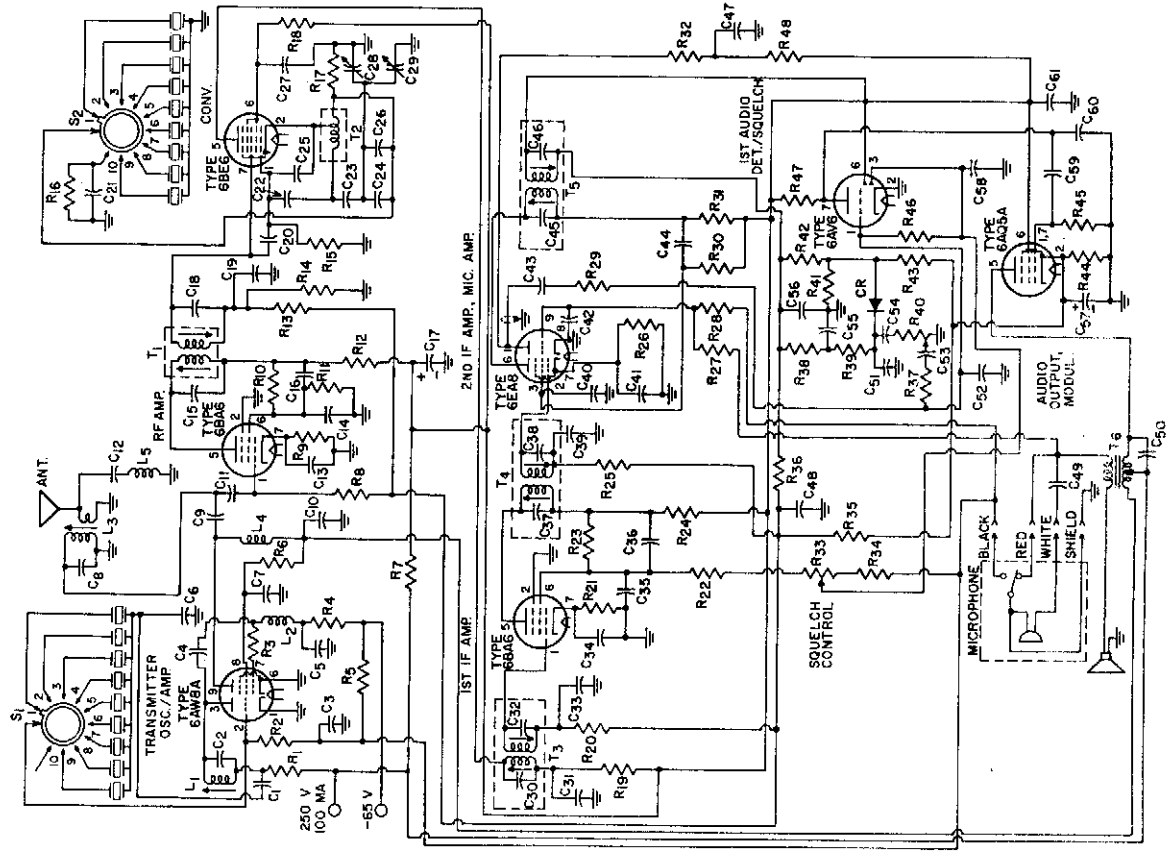

(22-7)

CITIZENS-BAND TRANSCEIVER (Cont'd)

- C_1 = 470 pf, ceramic, 500 v.
 C_2 = 3.3 pf, ceramic, 500 v.
 C_3 = C₃; C₃ C₁₀ C₁₁ C₁₄ C₁₇
 C_4 C₈ C₉ C₁₁ = 1000 pf, ceramic, 500 v.
 C_5 C₇ = 5 pf, ceramic, 500 v.
 C_6 = 190 pf, ceramic, 500 v.
 C_7 = 18 pf, mica, 500 v.
 C_8 = 24 pf, mica, 500 v.
 C_9 = 10 pf, ceramic, 500 v.
 C_{10} = 50 μ f, electrolytic, 500 v.
 C_{11} = 8 pf, ceramic, 500 v, N750
 C_{12} C₁₃ C₁₄ C₁₅ C₁₆ C₁₇
 C_{18} C₁₉ = 0.01 μ f, ceramic, 500 v.
 C_{20} = 2.2 pf, ceramic, 500 v.
 C_{21} = 270 pf, mica, 500 v.
 C_{22} C₂₃ = 56 pf, mica, 500 v.
 C_{24} = 62 pf, mica, 500 v.
 C_{25} = 18 pf, ceramic, 500 v., N750
 C_{26} = 56 pf, ceramic, 500 v., N880
 C_{27} = 0.015 μ f, paper, 400 v.
 C_{28} = Variable, 2.3—15 pf, ceramic, 600 v.
 C_{29} C₃₀ = Part of T₁
 C_{31} C₃₂ C₃₃ C₃₄ C₃₅ = 5000 pf, ceramic, 500 v.
 C_{36} C₃₇ = Part of T₂
 C_{38} C₃₉ = 100 pf, ceramic, 500 v.
 C_{40} C₄₁ C₄₂ C₄₃ C₄₄ C₄₅ C₄₆ C₄₇ C₄₈ C₄₉ C₅₀
 C_{51} = 4300 pf, paper, 600 v.
- R_1 = 150 ohms, 0.5 watt
 R_2 = 0.1 megohm, 0.5 watt
 R_3 = 0.68 megohm, 0.5 watt
 R_4 = 27000 ohms, 2 watts
 R_5 = 68000 ohms, 0.5 watt
 R_6 = 3 megohms, 0.25 watt
 R_7 = 0.33 megohm, 0.5 watt
 R_8 = 1 megohm, 0.5 watt
 R_9 = 2 megohms, 0.5 watt
 R_{10} = 0.22 megohm, 0.5 watt
 R_{11} = 330 ohms, 1 watt
 R_{12} = 8.2 megohms, 0.5 watt
 S_1 = Rotary switch, channel select transmit, RCA stock No. 226189 or equiv.
 S_2 = Rotary switch, channel select receive, RCA stock No. 226189 or equiv.
 T_1 = RF interstage transformer, RCA stock No. 226191 or equiv.
 T_2 = Oscillator coil, receiver, RCA stock No. 226192 or equiv.
 T_3 T₄ T₅ = IF transformers, RCA stock No. 226193 or equiv.
 T_6 = Output and modulation transformer, RCA stock No. 226194 or equiv.
- L_1 = Oscillator coil, transmitter, RCA stock No. 226189 or equiv.
 L_2 = 500 μ f, rf choke
 L_3 = Power-amplifier coil, RCA stock No. 226184 or equiv.
 L_4 = 2nd-harmonic trap, RCA stock No. 226187 or equiv.
 R_1 R₂ R₃ R₄ R₅ R₆ = 47000 ohms, 0.5 watt
 R_7 = 56 ohms, 0.5 watt
 R_8 R₉ R₁₀ R₁₁ R₁₂ = 27000 ohms, 0.5 watt
 R_{13} R₁₄ R₁₅ = 56000 ohms, 0.5 watt
 R_{16} = 5600 ohms, 1 watt
 R_{17} = 1000 ohms, 0.5 watt
 R_{18} R₁₉ = 18 megohm, 0.5 watt
 R_{20} = 27000 ohms, 0.5 watt
 R_{21} R₂₂ R₂₃ = 4700 ohms, 1 watt
 R_{24} R₂₅ R₂₆ = 2.2 megohms, 0.5 watt
 R_{27} = 39 ohms, 0.5 watt
 R_{28} = 82 ohms, 0.5 watt
 R_{29} = 15000 ohms, 1 watt
 R_{30} R₃₁ = 1.5 megohms, 0.5 watt
 R_{32} R₃₃ R₃₄ R₃₅ = 0.47 megohm,

NOTE: See general considerations for construction of high-frequency and broad-band circuits on page 504.

(22-10)

FM TUNER

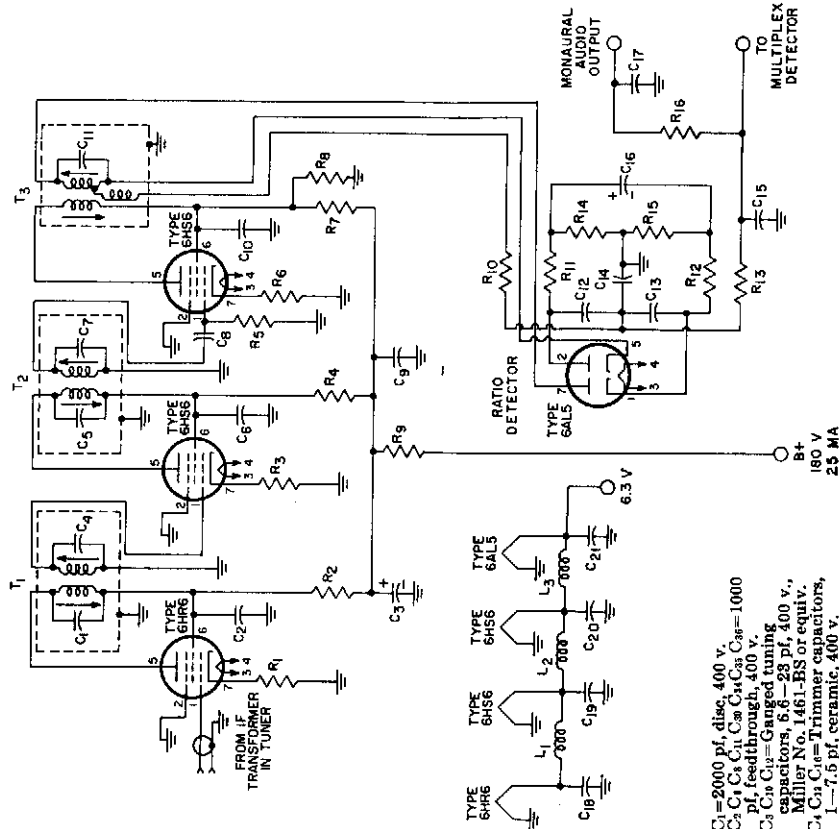

- C₁ = 2000 pf. disc, 400 v.
- C₂, C₃, C₄, C₅, C₆, C₇, C₈, C₉, C₁₀, C₁₁, C₁₂, C₁₃ = 1000 pf. feedthrough, 400 v.
- C₁₄, C₁₅ = Ganged tuning capacitors, 5.6 - 23 pf, 400 v., Miller No. 1461-FSS or equiv.
- C₁₆, C₁₇ = Trimmer capacitors, 1 - 7.5 pf, ceramic, 400 v.
- C₁₈, C₁₉ = 10 pf, ceramic, 400 v.
- C₂₀ = 2000 pf, ceramic, 400 v.
- C₂₁ = 10000 pf, ceramic, 400 v.
- C₂₂ = 22 pf, ceramic, 400 v.
- C₂₃ = 47 pf, ceramic, 400 v.
- C₂₄, C₂₅, C₂₆, C₂₇ = 0.01 μf, disc, 400 v.
- C₂₈ = 6.8 pf, ceramic, 400 v.
- C₂₉ = Part of T₁.
- C₃₀ = Capacitor inserted in place of tuning capacitor in secondary winding of T₁, value, with cable of T₁, tunes input to 10.7 MC.
- L₁ = 12 turns No. 22 Enam. close-wound on 1/4-inch coil form; slug ferrite Mullite No. 5101 ferrite or equiv.
- L₂ = 5 turns No. 22 Enam. close-wound on 1/4-inch coil form.
- L₃ = 4 μf, r choke, Miller
- * A metal shield should be provided between the grid and plate terminals on the socket for the 6CW4.
- If an AFC network is included, C₁₈ must be decreased by the capacitance loading the oscillator tank.

(22-11)

THREE-STAGE IF AMPLIFIER/LIMITER AND DETECTOR
For Monoaural or Stereo Tuner

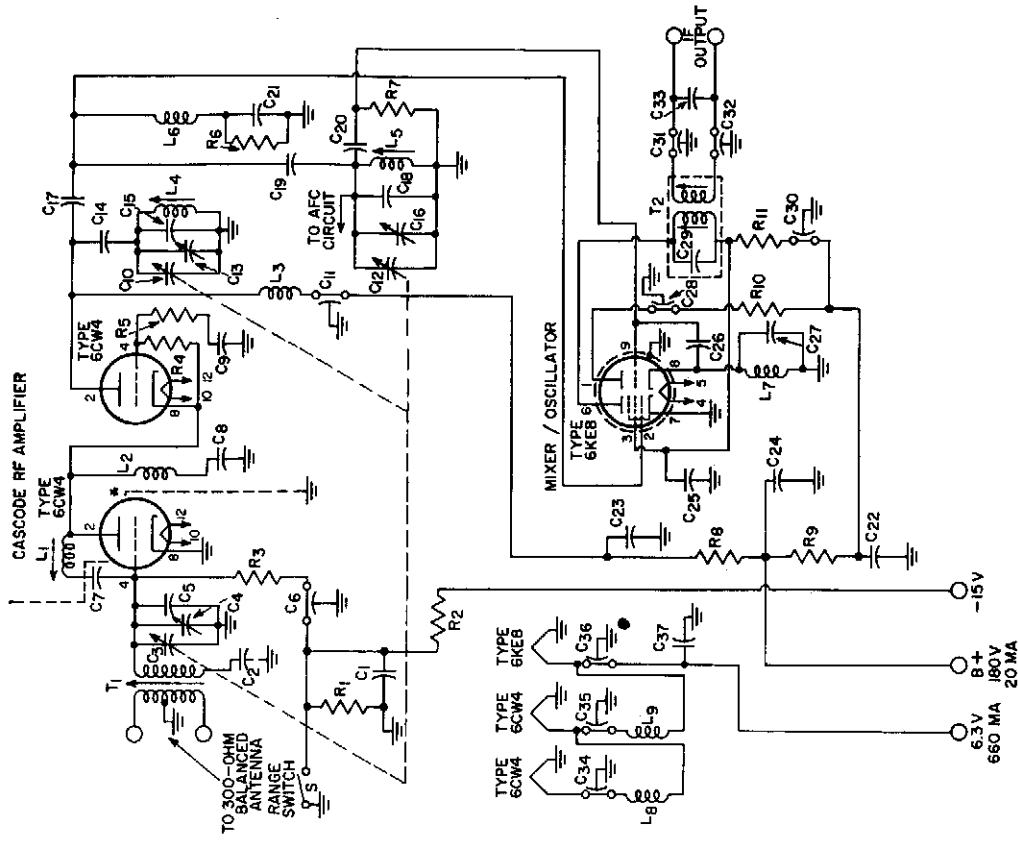

- C₁, C₂ = Part of T₁.
- C₃, C₄ = 2200 pf, ceramic disc, 400 v.
- C₅ = 50 pf, electrolytic, 450 v.
- C₆, C₇ = Part of T₂.
- C₈ = 47 pf, ceramic disc, 400 v.
- C₉, C₁₀, C₁₁, C₁₂ = 0.01 μf, ceramic disc, 400 v.
- C₁₃ = 1500 pf, ceramic disc, 400 v.
- C₁₄ = Part of T₃.
- C₁₅ = 68 ohms, 0.5 watt.
- C₁₆ = 3300 ohms, 0.5 watt.
- C₁₇ = 0.1 megohm, 0.5 watt.
- C₁₈ = 100 ohms, 0.5 watt.
- C₁₉ = 15000 ohms, 0.5 watt.
- C₂₀ = 22000 ohms, 0.5 watt.
- C₂₁ = 1200 ohms, 3 watts.
- C₂₂ = 890 ohms, 0.5 watt.
- C₂₃ = 6800 ohms, 0.5 watt.
- C₂₄ = 1 μh.
- C₂₅ = 68 ohms, 0.5 watt.
- C₂₆ = 3300 ohms, 0.5 watt.
- C₂₇ = 0.1 megohm, 0.5 watt.
- C₂₈ = Part of T₂.
- C₂₉ = 1000 pf, ceramic disc, 400 v.
- C₃₀ = 1000 pf, ceramic disc, 400 v.
- C₃₁, C₃₂ = 100 ohms, 0.5 watt.
- C₃₃ = 100 ohms, 0.5 watt.
- L₁, L₂, L₃ = 1 μh.
- L₄, L₅ = 68 ohms, 0.5 watt.
- L₆ = 3300 ohms, 0.5 watt.
- R₁ = 15000 ohms, 0.5 watt.
- R₂ = 3300 ohms, 0.5 watt.
- R₃ = 0.1 megohm, 0.5 watt.
- R₄ = 100 ohms, 0.5 watt.
- R₅ = 15000 ohms, 1 watt.
- R₆ = 4700 ohms, 0.5 watt.
- R₇ = 2200 ohms, 0.5 watt.
- R₈ = 15000 ohms, 0.5 watt.
- R₉ = 15000 ohms, 1 watt.
- R₁₀ = 15000 ohms, 1 watt.
- R₁₁ = A.M./F.M. range switch; open position is used for local stations, closed position for distant stations.
- T₁ = RF transformer; primary 2 turns No. 32 wire with type B nylon insulation, Alpha No. 1860 or equiv., center-tapped; secondary 3 turns No. 16 Enam. double-slug 1/4-inch coil form; slug 1/8-inch Mullite No. 5101 ferrite or equiv.
- T₂ = 10.7-Mc. if transformer; tuning capacitor in secondary removed and replaced by C₃₀.
- T₃ = Part of T₃.

NOTE: Tube shields may be required if regeneration is encountered. See general considerations for construction of high-frequency and broadband circuits on page 504.

(22-12)

FM STEREO MULTIPLEX ADAPTER

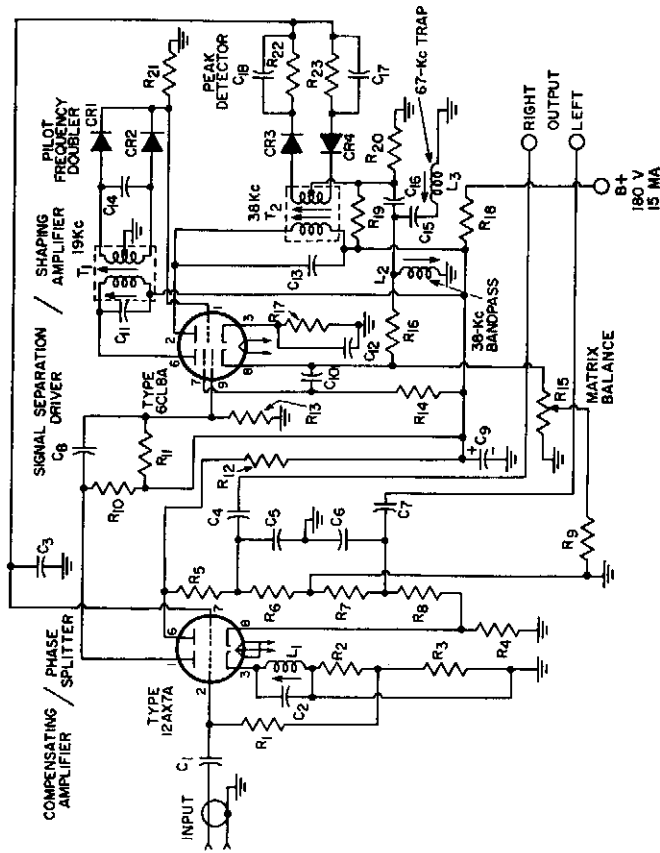

- C₁, C₂, C₃, C₁₂, C₁₃, C₁₇, C₁₈=0.01 μf, ceramic, 500 v.
- C₄, C₁₄=2200 pf, film, 500 v., N150
- C₅=470 pf, ceramic, 500 v.
- C₆=270 pf, ceramic, 500 v., N750
- C₇=0.047 μf, paper, 200 v.
- C₈=40 μf, electrolytic, 450 v.
- C₉=0.22 μf, paper, 400 v.
- C₁₀, C₁₆=1500 pf, film, 500 v., N150
- C₁₁=1000 pf, film, 500 v., N150
- C₁₅=3800 pf, ceramic, 500 v.
- CR₁, CR₂, CR₃, CR₄=Crystal diodes, RCA stock No.11207
- L₁, L₂=Coil, 67-Kc trap, RCA stock No.111047 or equiv.
- L₃=Coil, 38-Kc bandpass, RCA stock No.11048 or equiv.
- R₁=0.56 megohm, 0.5 watt
- R₂=15000 ohms, 0.5 watt
- R₃, R₄, R₅, R₆, R₇, R₈, R₉, R₁₀, R₁₁=22000 ohms, 0.5 watt
- R₁₂, R₁₃, R₁₄=0.1 megohm, 0.5 watt
- R₁₅=68000 ohms, 0.5 watt
- R₁₆=3.9 megohms, 0.5 watt
- R₁₇=1 megohm, 0.5 watt
- R₁₈, R₁₉=10000 ohms, 0.5 watt
- R₂₀, R₂₁, R₂₂=47000 ohms, 0.5 watt
- T₁=Transformer, 19-Kc, RCA stock No.111045 or equiv.
- T₂=Transformer, 38-Kc tank, RCA stock No. 111046 or equiv.

NOTE: See general considerations for construction of high-frequency and broad-band circuits on page 504.

(22-13)

HIGH-FIDELITY AUDIO AMPLIFIER
Class AB₁; Power Output, 15 Watts

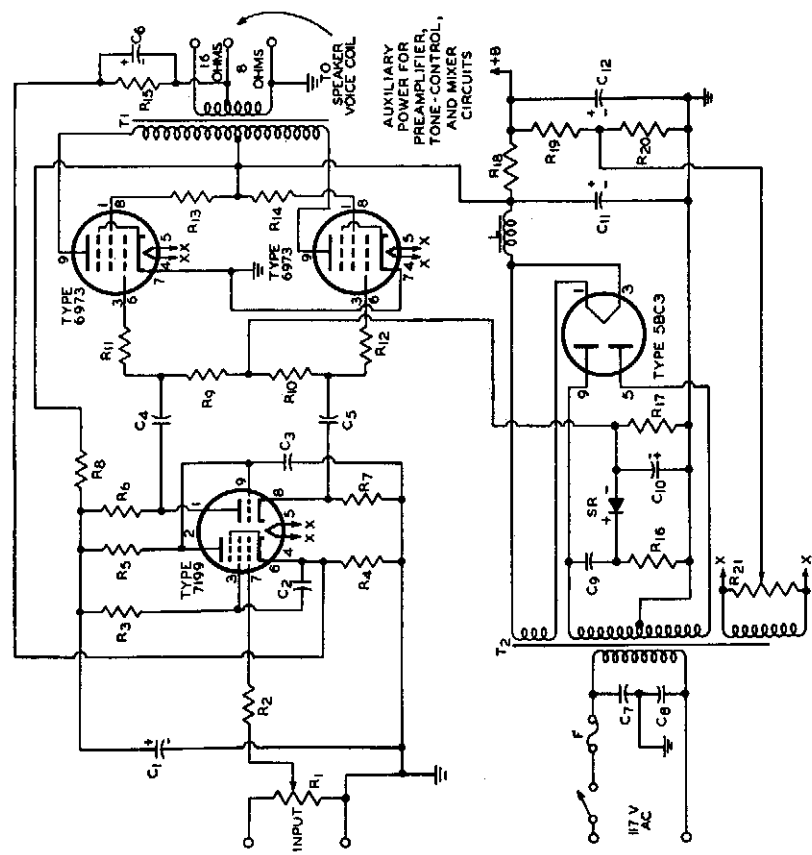

- C₁=40 μf, electrolytic, 450 v.
- C₂, C₃=0.25 μf, paper, 400 v.
- C₄=3.3 pf, ceramic or mica, 600 v.
- C₅=150 pf, ceramic or mica, 400 v.
- C₆, C₇=0.05 μf, paper, 400 v.
- C₈=0.02 μf, paper, 600 v.
- C₉=100 μf, electrolytic, 50 v.
- C₁₀=80 μf, electrolytic, 450 v.
- C₁₁=40 μf, electrolytic, 450 v.
- F=Fuse, 3 amperes
- L=Choke, 3 h., 150 ma., dc resistance 75 ohms or less
- R₁=Volume control, potentiometer, 1 megohm
- R₂=10000 ohms, 0.5 watt
- R₃=0.82 megohm, 0.5 watt
- R₄=820 ohms, 0.5 watt
- R₅=0.22 megohm, 0.5 watt
- R₆, R₇=15000 ohms ± 5 per cent, 2 watts
- R₈=3900 ohms, 2 watts
- R₉, R₁₀=0.1 megohm, 0.5 watt
- R₁₁, R₁₂=1000 ohms, 0.5 watt
- R₁₃, R₁₄=100 ohms, 0.5 watt
- R₁₅=8200 ohms, 0.5 watt
- R₁₆=15600 ohms, 1 watt
- R₁₇=68000 ohms, 1 watt
- R₁₈=4700 ohms, 2 watts
- R₁₉=0.27 megohm, 1 watt
- R₂₀=47000 ohms, 0.5 watt
- R₂₁=Hum balance adjustment, potentiometer, 100 ohms, 0.5 watt
- SR= Selenium rectifier, 20 ma., 135 volts rms
- T₁= Output transformer, (having 8-ohm tap for feedback connection) for matching impedance of voice coil to 6600-ohm plate-to-plate tube load; 50 watts; frequency response, 10 to 60000 cps.
- T₂= Power transformer, 360-0-360 volts rms, 120 ma.; 6.3 v., 3.5 a.; 5V, 3A.

(22-14)

HIGH-FIDELITY AUDIO AMPLIFIER
Class AB₁; Power Output, 30 Watts

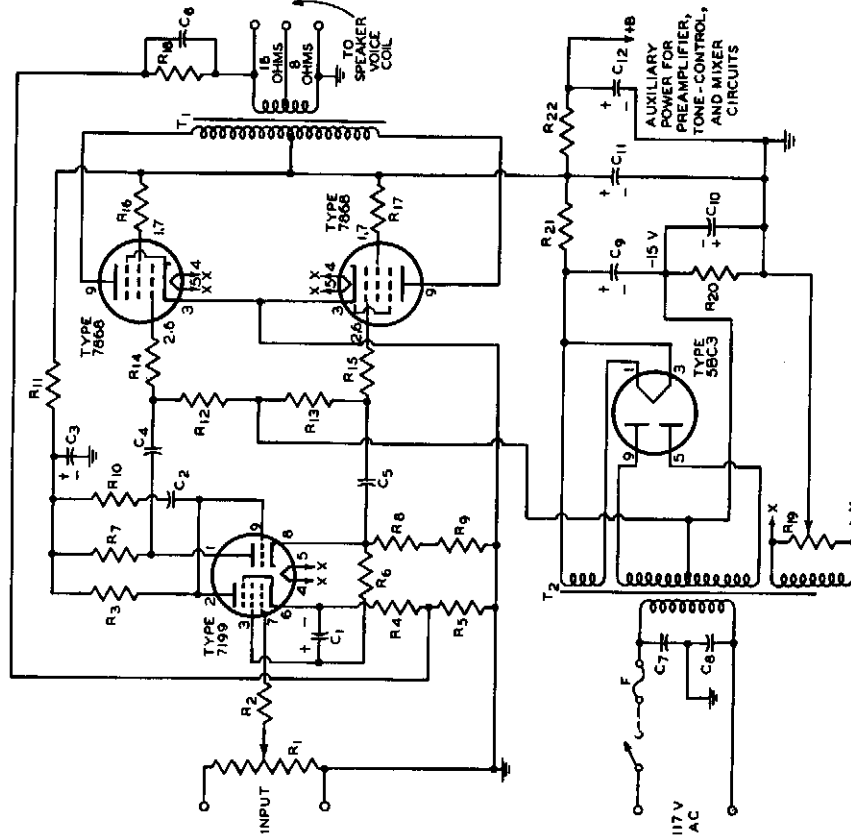

- C₁ = 25 μf, electrolytic, 50 v.
- C₂ = 22 pf, ceramic or mica, 600 v.
- C₃ = 80 μf, electrolytic, 600 v.
- C₄ = 0.25 μf, paper, 600 v.
- C₅ = 0.01 μf, paper, 600 v.
- C₆ = 0.05 μf, paper, 600 v.
- C₇ = 40 μf, electrolytic, 500 v.
- C₈ = 100 μf, electrolytic, 50 v.
- C₉ = 20 μf, electrolytic, 450 v.
- F = Fuse, 3 amperes, 150 v.
- R₁ = Volume control, potentiometer, 1 megohm
- R₂ = 10000 ohms, 0.5 watt
- R₃ = 25 megohm, 0.5 watt
- R₄ = 820 ohms, 0.5 watt
- R₅ = 10 ohms, 0.5 watt
- R₆ = 18 megohm, 0.5 watt
- R₇ = 15000 ohms ± 5 per cent, 2 watts
- R₈ = 15000 ohms ± 5 per cent, 0.5 watt
- R₉ = 1000 ohms, 10 watts
- R₁₀ = 50 ohms, 10 watts
- R₁₁ = 50 ohms, 10 watts
- R₁₂ = 120 ohms, 10 watts
- R₁₃ = 50 ohms, 10 watts
- R₁₄ = 20 ohms, 10 watts
- R₁₅ = 1000 ohms, 0.5 watt
- R₁₆ = 2000 ohms, 0.5 watt
- R₁₇ = 1000 ohms, 0.5 watt
- R₁₈ = 1000 ohms, 0.5 watt
- R₁₉ = 56 ohms, 0.5 watt
- R₂₀ = 270 ohms, 0.5 watt
- R₂₁ = 1000 ohms, 0.5 watt
- R₂₂ = 22000 ohms, 2 watts
- T₁ = Output transformer (having 1 ohm tap for feedback connection) for matching impedance of voice coil to 660-ohm plate-to-plate tube load; 50 watts; frequency response, 10 to 50000 cps.
- T₂ = Power transformer, 375-0-375 volts rms, 160 ma.; 5.3 v., 5 s.; 5 v., 3 s.

(22-15)

HIGH-FIDELITY AUDIO AMPLIFIER
Class AB₁; Power Output, 50 Watts

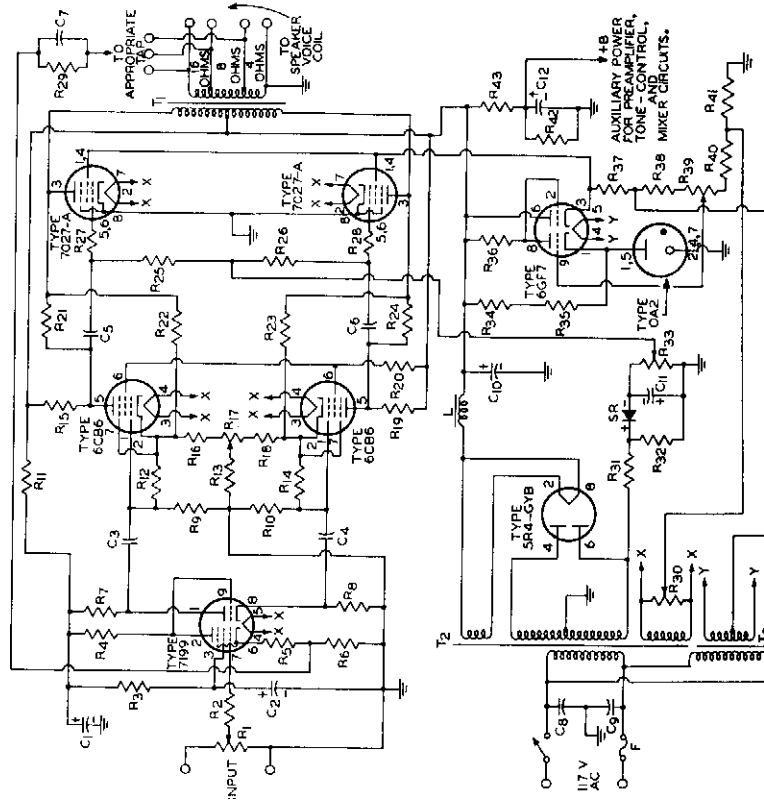

- C₁ = 40 μf, electrolytic, 450 v.
- C₂ = 0.02 μf, ceramic, 400 v.
- C₃ = 1 μf, paper, 400 v.
- C₄ = 0.002 μf to 4-ohm tap; 0.0015 μf to 8-ohm tap; or, 0.001 μf to 16-ohm tap; paper, 400 v.
- C₅ = 0.05 μf, paper, 600 v.
- C₆ = 20 μf, electrolytic, 600 v.
- C₇ = 100 μf, electrolytic, 150 v.
- C₈ = 40 μf, electrolytic, 450 v.
- F = Fuse, 5 amperes
- L = Choke, 8 h., 250 ma., dc resistance 60 ohms, or less
- R₁ = Volume control, potentiometer, 0.5 megohm
- R₂ = 4700 ohms, 0.5 watt
- R₃ = 0.82 megohm, 0.5 watt
- R₄ = 0.22 megohm, 0.5 watt
- R₅ = 820 ohms, 0.5 watt
- R₆ = 10 ohms, 0.5 watt
- R₇ = 15000 ohms, 2 watts
- R₈ = 1.5 megohms, 0.5 watt
- R₉ = 33000 ohms, 2 watts
- R₁₀ = 1.3 megohms, 0.5 watt
- R₁₁ = 47 ohms, 0.5 watt
- R₁₂ = 0.15 megohm, 0.5 watt
- R₁₃ = 390 ohms, 0.5 watt
- R₁₄ = AC balance control, potentiometer, 500 ohms, Note 4
- R₁₅ = 0.15 megohm, 1 watt
- R₁₆ = 0.33 megohm, 1 watt
- R₁₇ = 0.12 megohm, 2 watts
- R₁₈ = 0.1 megohm, 0.5 watt
- R₁₉ = 4700 ohms, 0.5 watt
- R₂₀ = 600 ohms to 4-ohm tap; or, 820 ohms to 8-ohm tap; or, 1200 ohms to 16-ohm tap; 0.5 watt
- R₂₁ = Hum balance adjustment, potentiometer, 100 ohms, Note 3
- R₂₂ = 0.12 megohm, 5 watts
- R₂₃ = 10 ohms, 2 watts
- R₂₄ = 15000 ohms, 2 watts
- R₂₅ = Bias adjustment, potentiometer, 50000 ohms, Note 1
- R₂₆ = 1.3 megohms, 0.5 watt
- R₂₇ = 10000 ohms, 1 watt
- R₂₈ = Screen-grid voltage adjustment, potentiometer, 25000 ohms, 2 watts, Note 2
- R₂₉ = 15000 ohms, 2 watts
- R₃₀ = 12000 ohms, 2 watts
- R₃₁ = 22000 ohms, 2 watts
- SR = Selenium rectifier, 20 ma., 135 volts rms
- T₁ = Output transformer for matching impedance of voice coil to 500-ohm plate-to-plate tube load; 50 watts; frequency response, 10 to 50000 cps
- T₂ = Power transformer, 500-0-500 volts rms, 200 ma., 6.3 v. s.; 5 v., 3 s.
- T₃ = Filament transformer, 6.3 volts, center tapped, 1 ampere

NOTES: All of the following adjustments should be made before amplifier is placed into operation.
(1) With 5R4-GYB rectifier out of socket, adjust R₂₁ for reading of -40 volts between junction of R₂₁ and R₂₅ and B- (ground bus). (2) With speaker connected, adjust R₂₆ for reading of 400 volts from speaker. (3) With input open and volume control R₁ set for maximum volume, adjust R₂₁ for minimum hum from speaker. (4) With input open and volume control R₁ set for maximum volume, adjust R₂₁ for minimum hum from speaker.

(21-16)

TWO-CHANNEL STEREOPHONIC AMPLIFIER

Power Output, 1 Watt Each Channel

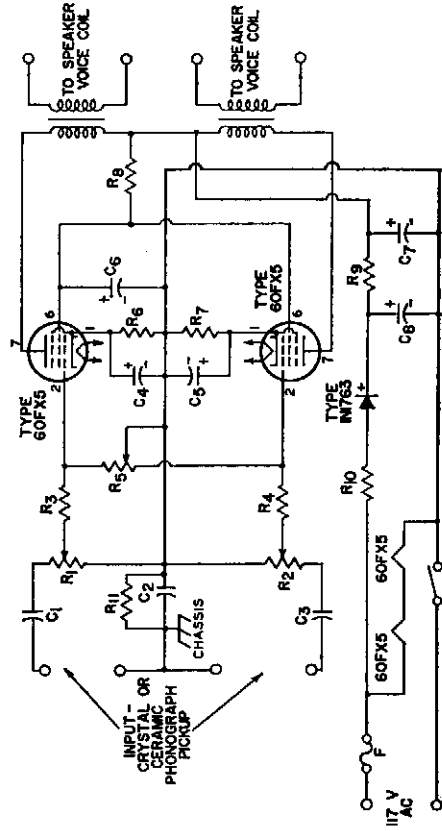

- C₁, C₂ = 0.22 μf, 400 v., paper
- C₃ = 0.1 μf, 400 v., paper
- C₄, C₅ = 50 μf, 25 v., electrolytic
- C₆ = 50 μf, 150 v., electrolytic
- C₇, C₈ = 50 μf, 150 v., electrolytic
- F = Fuse, 3 amperes
- R₁, R₂ = 220 ohms, 2 watts
- R₃ = 280 ohms, 2 watts
- R₄ = 12 ohms, 1 watt
- R₅ = 0.22 megohm, 0.5 watt
- T₁, T₂ = Output transformer for matching impedance of voice coil to 8000-ohm tube load.
- R₆, R₇ = 50 ohms, 1 watt
- R₈, R₉ = 47000 ohms, 0.5 watt
- R₁₀ = Balance control potentiometer, 2 megohms
- R₁, R₂ = 60 ohms, 1 watt

(22-17)

TWO-CHANNEL STEREOPHONIC AMPLIFIER

With Tone Control
Power Output, 1 Watt Each Channel

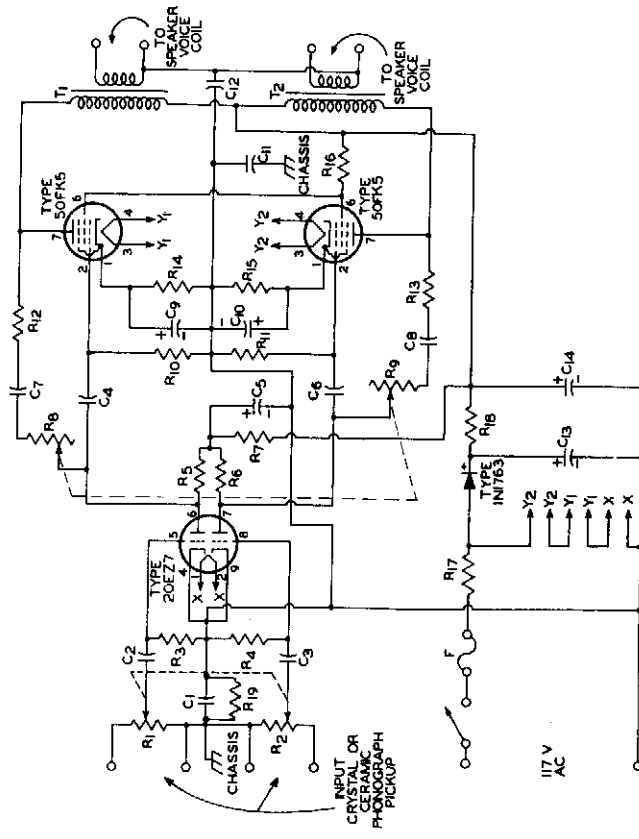

- C₁, C₂ = 0.047 μf, paper, 150 v.
- C₃ = 0.01 μf, paper, 150 v.
- C₄ = 0.022 μf, paper, 150 v.
- C₅ = 8 μf, electrolytic, 150 v.
- C₆ = 680 μf, ceramic or mica, 400 v.
- C₇, C₈ = 50 μf, electrolytic, 25 v.
- C₉ = 0.068 μf, paper, 150 v.
- C₁₀ = 200 μf, electrolytic, 150 v.
- C₁₁ = 100 μf, electrolytic, 150 v.
- C₁₂ = 100 μf, electrolytic, 150 v.
- F = Fuse, 2 amperes
- R₁, R₂ = Volume control potentiometer, 2 megohms, ganged
- R₃, R₄ = 10 megohms, 0.5 watt
- R₅, R₆ = 0.22 megohm, 1 watt
- R₇, R₈ = 0.022 megohm, 2 watts
- R₉, R₁₀ = Tone control potentiometer, 2 megohms, ganged
- R₁₁, R₁₂ = 0.47 megohm, 0.5 watt
- R₁₃, R₁₄ = 0.22 megohm, 0.5 watt
- T₁, T₂ = Output transformer for matching impedance of voice coil to 1000-ohm plate tube load. Turns ratio 20 to 1; primary current 80 ma. dc; power-handling capacity, 3.5 watts minimum.

(22-18)

TWO-CHANNEL AUDIO MIXER

Voltage Gain From Each Grid of 6EU7 to Output is Approximately 20

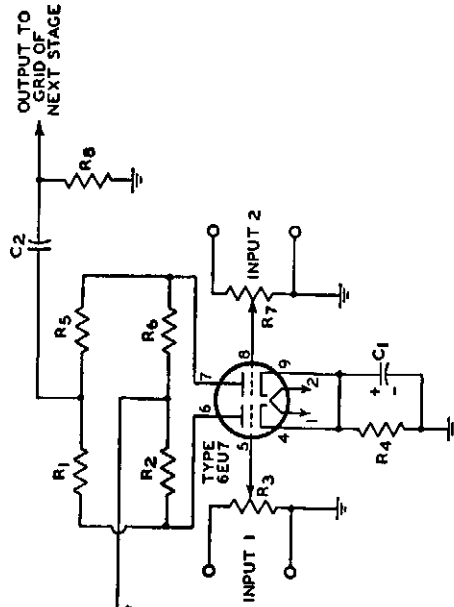

C₁=10 μf, electrolytic, 25 v.
C₂=0.05 μf, paper, 400 v.

R₁, R₄, R₅=1 megohm, 0.5 watt
R₂, R₃=0.1 megohm, 0.5 watt
R₆=1200 ohms, 0.5 watt

R₃, R₇=Potentiometers, 0.1 megohm, audio taper
R₄=1200 ohms, 0.5 watt

(22-19)

PHONOGRAPH AMPLIFIER

Power Output, 1 Watt

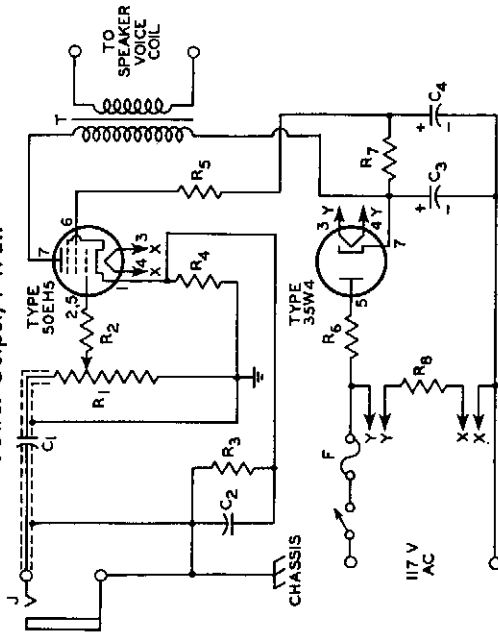

C₁=0.02 μf, paper, 400 v.
C₂=0.082 μf, paper, 400 v.
C₃, C₄=40 μf, electrolytic, 150 v.
F=Fuse, 1 ampere
J=Input connector, shielded, for crystal phonograph pickup.

R₁=Volume control, potentiometer, 0.5 megohm, audio taper
R₂=10000 ohms, 0.5 watt
R₃=0.22 megohm, 0.5 watt
R₄, R₅=56 ohms, 0.5 watt
R₆=22 ohms, 0.5 watt

R₇=3300 ohms, 1 watt
R₈=210 ohms, 10 watts
T=Output transformer for matching impedance of voice coil to 3000-ohm tube load.

(22-20)

MICROPHONE AND PHONOGRAPH AMPLIFIER

Power Output, 8 Watts

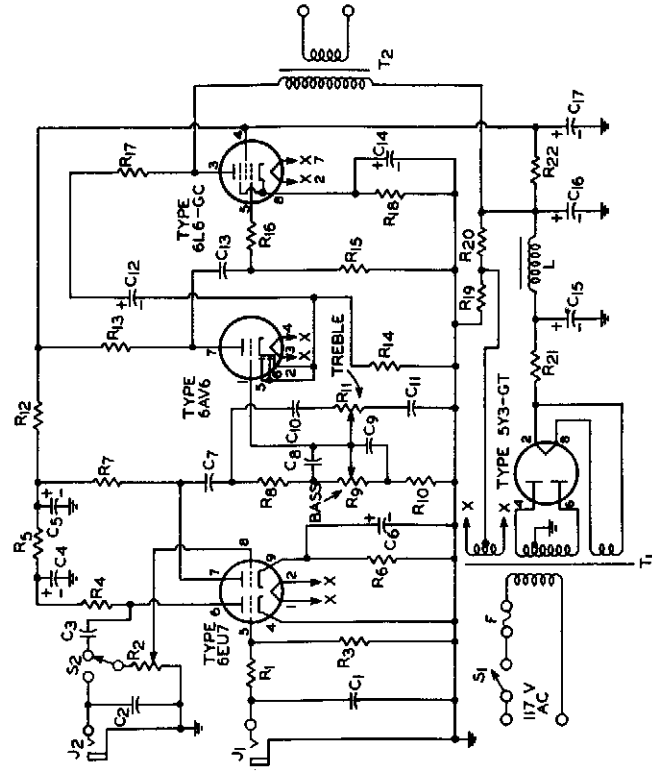

C₁, C₂=100 pf disc-ceramic, 300 v.
C₃=0.05 μf, paper, 200 v.
C₄=8 μf, electrolytic, 450 v.
C₅=16 μf, electrolytic, 450 v.
C₆=25 μf, electrolytic, 450 v.
C₇=0.1 μf, paper, 200 v.
C₈=0.001 μf, disc-ceramic, 300 v.
C₉=0.01 μf, disc-ceramic, 300 v.
C₁₀=470 pf, disc-ceramic, 300 v.
C₁₁=4700 pf, disc-ceramic, 300 v.
C₁₂=4 μf, electrolytic, 450 v.
C₁₃=0.05 μf, paper, 600 v.
C₁₄=25 μf, electrolytic, 25 v.
C₁₅, C₁₆, C₁₇=20 μf, electrolytic, 450 v.
F=Fuse, 1 ampere

J₁=Jack for high-impedance, crystal microphone input; max. input: 2 millivolts peak
J₂=Jack for crystal phonograph pickup input; max. input: 0.5 volt peak
L=Filter choke, 5 henries, 200 ma.
R₁, R₂=10000 ohms, 0.5 watt
R₃=Volume Control, potentiometer, 1 megohm
R₄, R₅=2.2 megohms, 0.5 watt
R₆, R₇, R₈=0.22 megohm, 0.5 watt
R₉=27000 ohms, 0.5 watt
R₁₀=1200 ohms, 0.5 watt
R₁₁, R₁₂=0.1 megohm, 0.5 watt
R₁₃, R₁₄=0.1 megohm, 0.5 watt
R₁₅=Tone control, potentiometer, 0.5 megohm

R₁₆=22000 ohms, 0.5 watt
R₁₇=12000 ohms, 0.5 watt
R₁₈=1800 ohms, 0.5 watt
R₁₉=0.47 megohm, 0.5 watt
R₂₀=0.15 megohm, 0.5 watt
R₂₁=180 ohms, 2 watts
R₂₂=47000 ohms, 1 watt
R₂₃=50 ohms, 10 watts
R₂₄=8200 ohms, 2 watts
S₁=Switch, SPST
S₂=Switch, SPDT
T₁=Power transformer, 900-0-900 v., 90 ma.; 6.3 v., 3.5 a., center tapped; 5 v., 2 a.
T₂=Output transformer for matching impedance of voice coil to 4000-ohm tube load; 10 watts

(22-21)

PREAMPLIFIER FOR AMATEUR RECEIVER FOR 10-METER (30-MEGACYCLE) BAND

Power Gain, 25 to 35 db

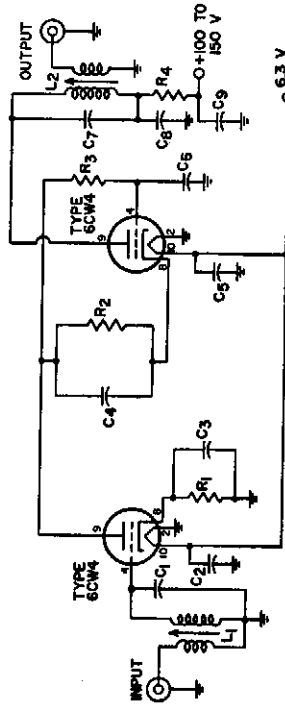

C₁, C₂ = 5 μf, 500 v, mica
 C₃, C₄, C₅, C₆, C₇, C₈, C₉, C₁₀ = 0.001 μf, 500 v, ceramic
 L₁, L₂ = 18 turns of No. 32 Enam. copper wire wound on 1/4" I.D. slug-tuned form. L₁ tuned to 32 Mc; L₂ to 29.5 Mc. Input and output link, 1 1/2 turns. Input and output impedance, 75 ohms.

(22-22)

PREAMPLIFIER FOR MAGNETIC PHONOGRAPH PICKUP

With RIAA Equalization

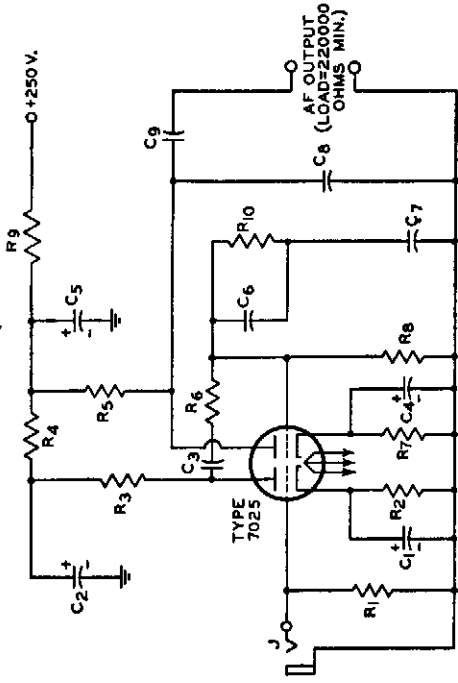

C₁, C₂ = 25 μf, electrolytic, 25 v.
 C₃, C₄ = 20 μf, electrolytic, 450 v.
 C₅ = 0.1 μf, paper, 600 v.
 C₆ = 0.0033 μf ± 5 per cent, paper, 600 v.
 C₇ = 0.01 μf ± 5 per cent, paper, 600 v.
 C₈ = 180 pf ± 5 per cent, ceramic or mica, 500 v. (includes capacitance of output cable)
 R₁, R₂ = 2700 ohms, 0.5 watt
 R₃, R₄ = 0.1 megohm, 0.5 watt
 R₅ = 39000 ohms, 0.5 watt
 R₆ = 0.47 megohm, 0.5 watt
 R₇ = 0.68 megohm, 0.5 watt
 R₈ = 15000 ohms, 1 watt
 R₉ = 22000 ohms, 0.5 watt

526

(22-23)

PREAMPLIFIER FOR CERAMIC PHONOGRAPH PICKUP

Cathode-Follower (Low-Impedance) Output

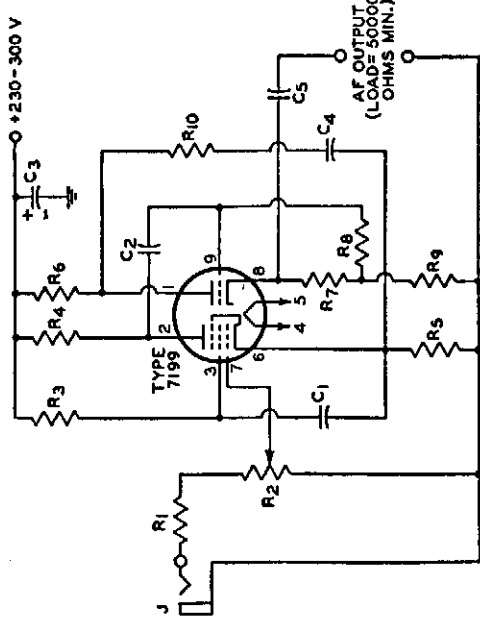

C₁ = 0.1 μf, paper, 400 v.
 C₂ = 0.01 μf, paper, 400 v.
 C₃ = 20 μf, electrolytic, 400 v.
 C₄ = 0.25 μf, paper, 400 v.
 C₅ = 0.22 μf, paper, 600 v.
 J = Input connector, shielded, for high-impedance ceramic

R₁ = 0.22 megohm, 0.5 watt
 R₂ = 1.8 megohms, 0.5 watt
 R₃ = 47000 ohms, 0.5 watt
 R₄ = 4700 ohms, 0.5 watt
 R₅ = 1 megohm, 0.5 watt
 R₆ = 18000 ohms, 0.5 watt

(22-24)

LOW-DISTORTION PREAMPLIFIER
 For Low-Output High-Impedance Microphones

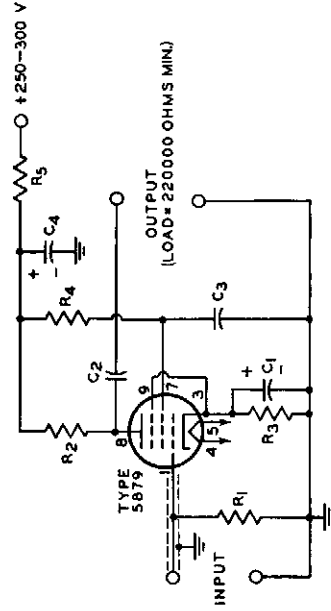

C₁ = 25 μf, electrolytic, 25 v.
 C₂ = 0.04 μf, paper, 400 v.
 C₃ = 0.22 μf, paper, 400 v.
 C₄ = 40 μf, electrolytic, 450 v.
 C₅ = 2.2 megohms, 0.5 watt
 C₆ = 0.1 megohm, 0.5 watt

R₁ = 1000 ohms, 0.5 watt
 R₂ = 0.47 megohm, 0.5 watt
 R₃ = 22000 ohms, 0.5 watt

Sensitivity = 3 millivolts for output of 220 millivolts

527

(22-25)

TWO-STAGE INPUT AMPLIFIER

Cathode-Follower (Low-Impedance) Output

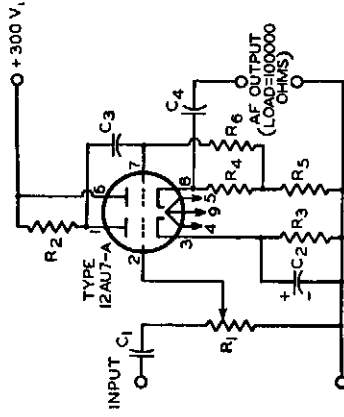

C₁ C₂=0.1 μf, paper, 400 v.
C₃=25 μf, electrolytic, 25 v.
C₄=0.5 μf, paper, 200 v.

R₁ R₂=5600 ohms, 0.5 watt
R₃=27000 ohms, 0.5 watt
R₄=0.56 megohm, 0.5 watt

(22-26)

BASS AND TREBLE TONE-CONTROL AMPLIFIER STAGE

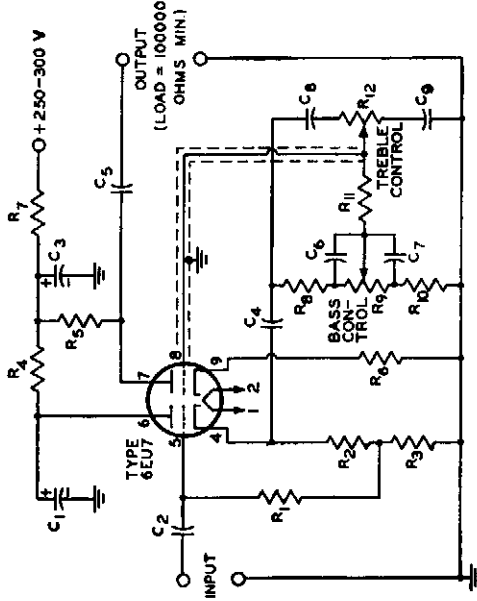

C₁ C₂=20 μf, electrolytic, 450 v.
C₃=0.047 μf, paper, 400 v.
C₄=0.1 μf, paper, 400 v.
C₅=0.22 μf, paper, 400 v.
C₆=0.0022 μf, paper, 400 v.
C₇=0.022 μf, paper, 400 v.
C₈=220 pf, ceramic or mica, 500 v.

R₁ R₂=1000 ohms, 0.5 watt
R₃=Bass control, potentiometer, 1 megohm
R₄=1500 ohms, 0.5 watt
R₅=15000 ohms, 0.3 watt
R₆=10000 ohms, 0.3 watt
R₇=Treble control, potentiometer, 1 megohm

Sensitivity=0.5 volt rms for output of 1.25 volts with controls set for flat response.

(22-27)

AUDIO CONTROL UNIT
With Volume and Tone Controls

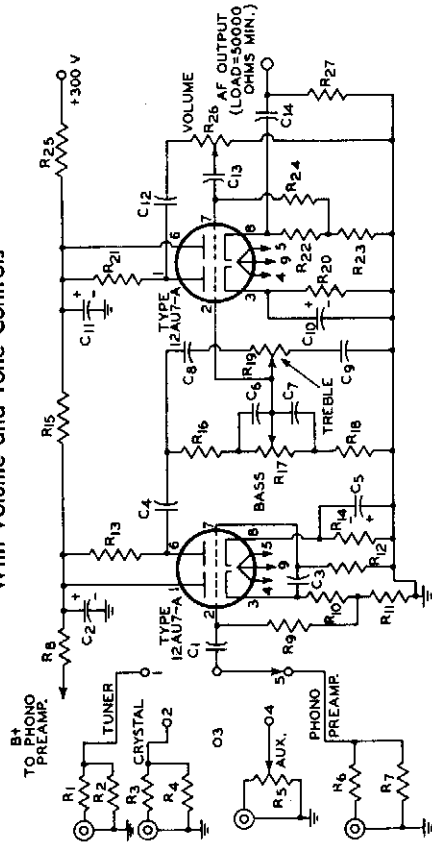

C₁ C₂=0.01 μf, paper, 400 v.
C₃ C₄=20 μf, electrolytic, 450 v.
C₅ C₆=0.1 μf, paper, 400 v.
C₇ C₈=25 μf, electrolytic, 25 v.
C₉ C₁₀=0.001 μf, paper, 400 v.
C₁₁=470 pf, mica, 300 v.
C₁₂ C₁₃=1000 pf, mica, 300 v.
C₁₄ C₁₅=0.033 μf, paper, 400 v.
C₁₆ C₁₇=0.022 μf, paper, 400 v.
C₁₈ C₁₉=0.27 megohm, 0.5 watt
C₂₀ C₂₁=0.1 megohm, 0.5 watt

R₁ R₂=1.5 megohms, 0.5 watt
R₃=2 megohms, 0.5 watt
R₄=Potentiometer, 0.5 megohm, audio taper.
R₅=22000 ohms, 0.5 watt
R₆=0.33 megohm, 0.5 watt
R₇ R₈ R₉=15000 ohms, 0.5 watt
R₁₀=0.56 megohm, 0.5 watt
R₁₁ R₁₂=2200 ohms, 0.5 watt
R₁₃ R₁₄=0.22 megohm, 0.5 watt
R₁₅ R₁₆=1 megohm, 0.5 watt
R₁₇ R₁₈=0.1 megohm, 0.5 watt
R₁₉ R₂₀=Potentiometer, 0.1 megohm, audio taper

(22-28)

CODE-PRACTICE OSCILLATOR

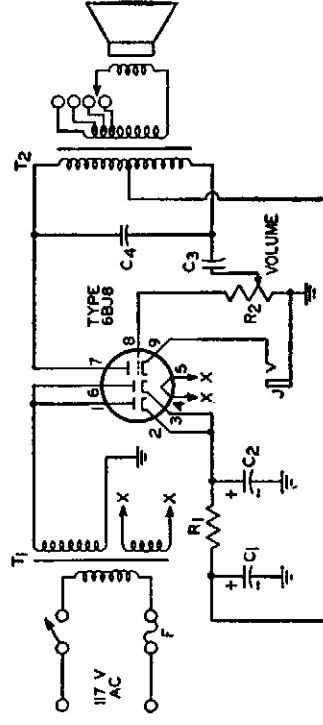

C₁ C₂=20 μf, electrolytic, 150 v.
C₃=0.001 μf, paper, 200 v.
C₄=0.03 μf, paper, 200 v.
F=1/8 ampere

R₁=1500 ohms, 1 watt
R₂=Potentiometer, 0.1 megohm, 0.5 watt
R₃=1/8 ampere
T₁=Power transformer, 125 volts rms, 15 ma; 6.3 volts, 0.6 ampere
T₂=Output transformer, universal

NOTE: Select any two terminals of secondary of T₁ to give desired tone.

(22-30)

ALL-PURPOSE POWER SUPPLY

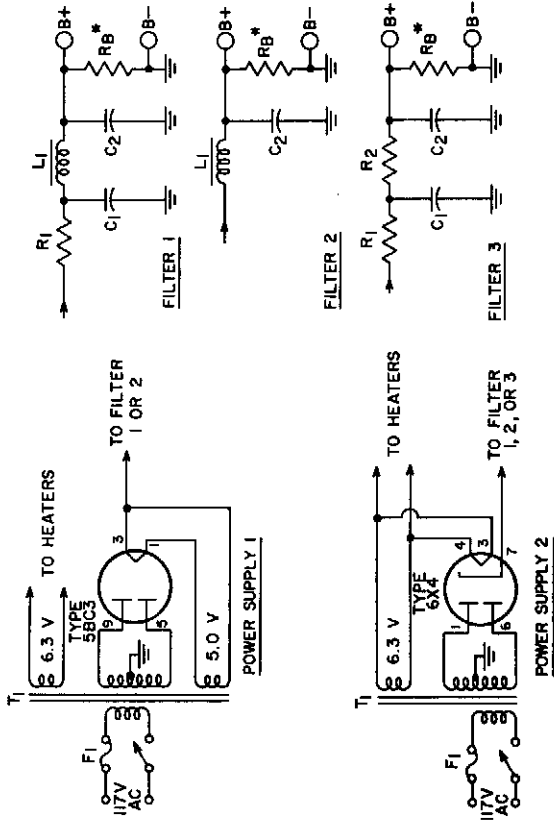

POWER SUPPLY	TRANSFORMER	CHOKE (L ₁)	R ₁	R ₂	C ₁	C ₂	FILTER VOLTS	MA
1 (6BC3)	Stancor PC or PM 8177	140 ma, 7h, 165 ohms Stancor C1421 or equiv.	83 ohms 5W	—	40 μf 450 Vdc	40 μf 450 Vdc	360 340 320	60 80 120
	Stancor PC or PM 8412	200 ma, 4h, 145 ohms Thorndarson 20C54 or equiv.	56 ohms 10W	—	40 μf 600 Vdc	40 μf 600 Vdc	450 425 410	120 160 200
	Stancor P-6368 (300-0-300) or equiv.	80 ma, 12h, 375 ohms Thorndarson 20C58 or equiv.	500 ohms 5W	500 ohms 3W	40 μf 450 Vdc	40 μf 450 Vdc	350 300 260	20 40 60
2 (6X4)	Stancor PC or PM 8419	80 ma, 12h, 500 ohms Thorndarson 20C58 or equiv.	500 ohms 5W	500 ohms 3W	40 μf 450 Vdc	40 μf 450 Vdc	250 230 220	20 40 60
	Stancor P-6368 (300-0-300) or equiv.	80 ma, 12h, 375 ohms Thorndarson 20C58 or equiv.	500 ohms 5W	500 ohms 3W	40 μf 450 Vdc	40 μf 450 Vdc	345 300 250	20 40 60
	Stancor PM or PC 8419	80 ma, 12h, 500 ohms Thorndarson 20C58 or equiv.	500 ohms 5W	500 ohms 3W	40 μf 450 Vdc	40 μf 450 Vdc	265 225 190	20 40 60

NOTE: Bleeder R_g can be omitted if an external load is permanently connected across the output terminals. Bleeder current should be approximately 10 per cent of the load current.

(22-29)

INTERCOMMUNICATION SET

With Master Unit and Two or More Remote Units

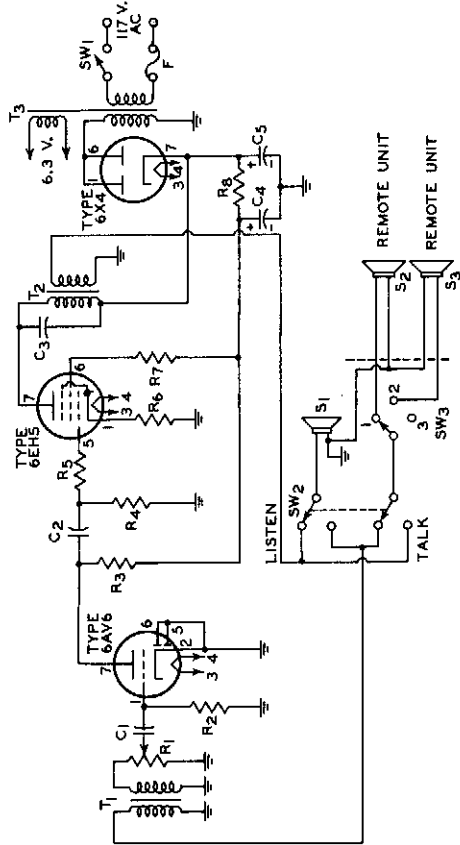

- C₁, C₂ = 0.0022 μf, paper, 200 v.
- C₃ = 0.005 μf, paper, 200 v.
- C₄, C₅ = 60 μf, electrolytic, 150 v.
- F = Fuse, 1 ampere
- R₁ = Volume control, potentiometer, 0.5 megohm, audio taper
- R₂ = 6.5 megohms, 0.5 watt
- R₃, R₄ = 0.47 megohm, 0.5 watt
- R₅ = 10000 ohms, 0.5 watt
- R₆, R₇ = 68 ohms, 0.5 watt
- R₈ = 2200 ohms, 1 watt
- S₁, S₂, S₃ = Speaker, permanent-magnet, voice-coil impedance at 1000 cps, 25000-ohm secondary
- SW₁ = Station-selector switch, rotary
- T₁ = Input transformer, 4-ohm primary, 25000-ohm secondary
- T₂ = Output transformer, 3000-ohm primary, 4-ohm secondary
- T₃ = Power transformer, 120 volts rms, 50 ma., 6.3 volts rms, 2 amperes

NOTES: The leads from the LISTEN-TALK switch to T₁ and T₂ should be kept as far apart as possible to prevent undesirable regeneration effects. Connections to the remote speaker units should be made with low-resistance wire, preferably shielded "intercom" cable.

Index

Absolute Maximum System of Ratings	69
AC/DC Superheterodyne Receiver.....	509
AC-Operated Superheterodyne Receiver.....	508
Admittance Input.....	16
All-purpose Power Supply.....	531
AM Detection.....	42
AM/FM Receiver.....	514
Amplification.....	14
Amplification Factor (μ).....	12
Amplifier:	
audio control unit, circuit.....	529
audio-frequency.....	14
audio mixer, circuit.....	524
cathode-drive.....	27
cathode-follower.....	27, 30
cathode-follower, circuit.....	527, 528
class A.....	14, 17
class AB.....	14, 22
class AB ₂	23
class B.....	25
class B _c	14, 26
class C.....	14
high-fidelity.....	26, 66, 519-521
intermediate-frequency.....	517
limiter.....	36, 45
low-distortion input, circuit.....	527
luminescence.....	38
parallel.....	17
phase-inverter.....	38
preamplifier, circuit.....	526, 527
push-pull.....	17, 20
radio-frequency.....	14, 36
remote-cutoff.....	16, 50
resistance-coupled.....	15, 29, 491
sharp-cutoff.....	50
sync.....	39
television.....	36
tone-control.....	34
tone-control, circuit.....	528
video.....	37
volume.....	14
volume-expander.....	32
Amplitude Modulation (AM).....	42
AM Tuner.....	515
Anode.....	5
Application Guide for RCA Receiving Tubes.....	75
Arc-Back Limit.....	72
Audio Control Unit with Volume and Tone Controls.....	529
Audio Mixer.....	524
Audio Signal Generator.....	584
Automatic Frequency Control (AFC).....	56
Automatic Gain Control (AGC).....	46, 48
Automatic Volume Control (AVC).....	46
Automobile Receiver.....	510
Bass and Treble Tone-Control Amplifier Stage	528
Beam Power Tubes:	
battery.....	60
cathode (self).....	60, 61
diode.....	43
grid-resistor.....	528
cathode-ray oscilloscope.....	532
citizens-band transmitter.....	512
grid-resistor and capacitor.....	512
ratio detector.....	512
static.....	512
stage.....	512
bass and treble tone-control amplifier.....	512
bass and treble tone-control amplifier.....	510
automobile receiver.....	534
audio signal generator.....	529
audio-control unit.....	514
AM/FM receiver.....	531
All-purpose power supply.....	531
ac-operated superheterodyne receiver.....	508
ac/dc superheterodyne receiver.....	509
Circuit Diagram of:	
Chrominance Channel.....	38
Choke-Input Filter.....	65
resistance-coupled amplifier.....	491
outline drawings.....	600
picture tube characteristics chart.....	484
grid-No. 2 input rating chart.....	70
Charts and Tables:	
static.....	12
plate resistance.....	12
dynamic.....	12
conversion transconductance.....	13
control-grid-plate transconductance.....	13
amplification factor.....	12
control-grid-plate transconductance.....	12
characteristic curves, interpretation of.....	73
Characteristic Curves, Interpretation of:	
types.....	3
ionic-heated.....	61
resistor.....	61
directly heated.....	3
drive.....	27
follow.....	27, 30, 527, 528
indirectly heated.....	4
remote-cutoff.....	4
resistance-coupled.....	6
sharp-cutoff.....	6
sync.....	6
television.....	6
tone-control.....	6
tone-control, circuit.....	6
video.....	6
volume.....	6
volume-expander.....	6
Amplitude Modulation (AM).....	6
AM Tuner.....	6
Anode.....	6
Application Guide for RCA Receiving Tubes.....	6
Arc-Back Limit.....	6
Audio Control Unit with Volume and Tone Controls.....	6
Audio Mixer.....	6
Audio Signal Generator.....	6
Automatic Frequency Control (AFC).....	6
Automatic Gain Control (AGC).....	6
Automatic Volume Control (AVC).....	6
Automobile Receiver.....	6
Bass and Treble Tone-Control Amplifier Stage	6
Beam Power Tubes:	
battery.....	6
cathode (self).....	6
diode.....	6
grid-resistor.....	6
cathode-ray oscilloscope.....	6
citizens-band transmitter.....	6
grid-resistor and capacitor.....	6
ratio detector.....	6
static.....	6
stage.....	6
bass and treble tone-control amplifier.....	6
bass and treble tone-control amplifier.....	6
automobile receiver.....	6
audio signal generator.....	6
audio-control unit.....	6
AM/FM receiver.....	6
All-purpose power supply.....	6
ac-operated superheterodyne receiver.....	6
ac/dc superheterodyne receiver.....	6
Circuit Diagram of:	
Chrominance Channel.....	6
Choke-Input Filter.....	6
resistance-coupled amplifier.....	6
outline drawings.....	6
picture tube characteristics chart.....	6
grid-No. 2 input rating chart.....	6
Charts and Tables:	
static.....	6
plate resistance.....	6
dynamic.....	6
conversion transconductance.....	6
control-grid-plate transconductance.....	6
amplification factor.....	6
control-grid-plate transconductance.....	6
characteristic curves, interpretation of.....	6
Characteristic Curves, Interpretation of:	
types.....	6
ionic-heated.....	6
resistor.....	6
directly heated.....	6
drive.....	6
follow.....	6
indirectly heated.....	6
remote-cutoff.....	6
resistance-coupled.....	6
sharp-cutoff.....	6
sync.....	6
television.....	6
tone-control.....	6
tone-control, circuit.....	6
video.....	6
volume.....	6
volume-expander.....	6
Amplitude Modulation (AM).....	6
AM Tuner.....	6
Anode.....	6
Application Guide for RCA Receiving Tubes.....	6
Arc-Back Limit.....	6
Audio Control Unit with Volume and Tone Controls.....	6
Audio Mixer.....	6
Audio Signal Generator.....	6
Automatic Frequency Control (AFC).....	6
Automatic Gain Control (AGC).....	6
Automatic Volume Control (AVC).....	6
Automobile Receiver.....	6
Bass and Treble Tone-Control Amplifier Stage	6
Beam Power Tubes:	
battery.....	6
cathode (self).....	6
diode.....	6
grid-resistor.....	6
cathode-ray oscilloscope.....	6
citizens-band transmitter.....	6
grid-resistor and capacitor.....	6
ratio detector.....	6
static.....	6
stage.....	6
bass and treble tone-control amplifier.....	6
bass and treble tone-control amplifier.....	6
automobile receiver.....	6
audio signal generator.....	6
audio-control unit.....	6
AM/FM receiver.....	6
All-purpose power supply.....	6
ac-operated superheterodyne receiver.....	6
ac/dc superheterodyne receiver.....	6
Circuit Diagram of:	
Chrominance Channel.....	6
Choke-Input Filter.....	6
resistance-coupled amplifier.....	6
outline drawings.....	6
picture tube characteristics chart.....	6
grid-No. 2 input rating chart.....	6
Charts and Tables:	
static.....	6
plate resistance.....	6
dynamic.....	6
conversion transconductance.....	6
control-grid-plate transconductance.....	6
amplification factor.....	6
control-grid-plate transconductance.....	6
characteristic curves, interpretation of.....	6
Characteristic Curves, Interpretation of:	
types.....	6
ionic-heated.....	6
resistor.....	6
directly heated.....	6
drive.....	6
follow.....	6
indirectly heated.....	6
remote-cutoff.....	6
resistance-coupled.....	6
sharp-cutoff.....	6
sync.....	6
television.....	6
tone-control.....	6
tone-control, circuit.....	6
video.....	6
volume.....	6
volume-expander.....	6
Amplitude Modulation (AM).....	6
AM Tuner.....	6
Anode.....	6
Application Guide for RCA Receiving Tubes.....	6
Arc-Back Limit.....	6
Audio Control Unit with Volume and Tone Controls.....	6
Audio Mixer.....	6
Audio Signal Generator.....	6
Automatic Frequency Control (AFC).....	6
Automatic Gain Control (AGC).....	6
Automatic Volume Control (AVC).....	6
Automobile Receiver.....	6
Bass and Treble Tone-Control Amplifier Stage	6
Beam Power Tubes:	
battery.....	6
cathode (self).....	6
diode.....	6
grid-resistor.....	6
cathode-ray oscilloscope.....	6
citizens-band transmitter.....	6
grid-resistor and capacitor.....	6
ratio detector.....	6
static.....	6
stage.....	6
bass and treble tone-control amplifier.....	6
bass and treble tone-control amplifier.....	6
automobile receiver.....	6
audio signal generator.....	6
audio-control unit.....	6
AM/FM receiver.....	6
All-purpose power supply.....	6
ac-operated superheterodyne receiver.....	6
ac/dc superheterodyne receiver.....	6
Circuit Diagram of:	
Chrominance Channel.....	6
Choke-Input Filter.....	6
resistance-coupled amplifier.....	6
outline drawings.....	6
picture tube characteristics chart.....	6
grid-No. 2 input rating chart.....	6
Charts and Tables:	
static.....	6
plate resistance.....	6
dynamic.....	6
conversion transconductance.....	6
control-grid-plate transconductance.....	6
amplification factor.....	6
control-grid-plate transconductance.....	6
characteristic curves, interpretation of.....	6
Characteristic Curves, Interpretation of:	
types.....	6
ionic-heated.....	6
resistor.....	6
directly heated.....	6
drive.....	6
follow.....	6
indirectly heated.....	6
remote-cutoff.....	6
resistance-coupled.....	6
sharp-cutoff.....	6
sync.....	6
television.....	6
tone-control.....	6
tone-control, circuit.....	6
video.....	6
volume.....	6
volume-expander.....	6
Amplitude Modulation (AM).....	6
AM Tuner.....	6
Anode.....	6
Application Guide for RCA Receiving Tubes.....	6
Arc-Back Limit.....	6
Audio Control Unit with Volume and Tone Controls.....	6
Audio Mixer.....	6
Audio Signal Generator.....	6
Automatic Frequency Control (AFC).....	6
Automatic Gain Control (AGC).....	6
Automatic Volume Control (AVC).....	6
Automobile Receiver.....	6
Bass and Treble Tone-Control Amplifier Stage	6
Beam Power Tubes:	
battery.....	6
cathode (self).....	6
diode.....	6
grid-resistor.....	6
cathode-ray oscilloscope.....	6
citizens-band transmitter.....	6
grid-resistor and capacitor.....	6
ratio detector.....	6
static.....	6
stage.....	6
bass and treble tone-control amplifier.....	6
bass and treble tone-control amplifier.....	6
automobile receiver.....	6
audio signal generator.....	6
audio-control unit.....	6
AM/FM receiver.....	6
All-purpose power supply.....	6
ac-operated superheterodyne receiver.....	6
ac/dc superheterodyne receiver.....	6
Circuit Diagram of:	
Chrominance Channel.....	6
Choke-Input Filter.....	6
resistance-coupled amplifier.....	6
outline drawings.....	6
picture tube characteristics chart.....	6
grid-No. 2 input rating chart.....	6
Charts and Tables:	
static.....	6
plate resistance.....	6
dynamic.....	6
conversion transconductance.....	6
control-grid-plate transconductance.....	6
amplification factor.....	6
control-grid-plate transconductance.....	6
characteristic curves, interpretation of.....	6
Characteristic Curves, Interpretation of:	
types.....	6
ionic-heated.....	6
resistor.....	6
directly heated.....	6
drive.....	6
follow.....	6
indirectly heated.....	6
remote-cutoff.....	6
resistance-coupled.....	6
sharp-cutoff.....	6
sync.....	6
television.....	6
tone-control.....	6
tone-control, circuit.....	6
video.....	6
volume.....	6
volume-expander.....	6
Amplitude Modulation (AM).....	6
AM Tuner.....	6
Anode.....	6
Application Guide for RCA Receiving Tubes.....	6
Arc-Back Limit.....	6
Audio Control Unit with Volume and Tone Controls.....	6
Audio Mixer.....	6
Audio Signal Generator.....	6
Automatic Frequency Control (AFC).....	6
Automatic Gain Control (AGC).....	6
Automatic Volume Control (AVC).....	6
Automobile Receiver.....	6
Bass and Treble Tone-Control Amplifier Stage	6
Beam Power Tubes:	
battery.....	6
cathode (self).....	6
diode.....	6
grid-resistor.....	6
cathode-ray oscilloscope.....	6
citizens-band transmitter.....	6
grid-resistor and capacitor.....	6
ratio detector.....	6
static.....	6
stage.....	6
bass and treble tone-control amplifier.....	6
bass and treble tone-control amplifier.....	6
automobile receiver.....	6
audio signal generator.....	6
audio-control unit.....	6
AM/FM receiver.....	6
All-purpose power supply.....	6
ac-operated superheterodyne receiver.....	6
ac/dc superheterodyne receiver.....	6
Circuit Diagram of:	
Chrominance Channel.....	6
Choke-Input Filter.....	6
resistance-coupled amplifier.....	6
outline drawings.....	6
picture tube characteristics chart.....	6
grid-No. 2 input rating chart.....	6
Charts and Tables:	
static.....	6
plate resistance.....	6
dynamic.....	6
conversion transconductance.....	6
control-grid-plate transconductance.....	6
amplification factor.....	6
control-grid-plate transconductance.....	6
characteristic curves, interpretation of.....	6
Characteristic Curves, Interpretation of:	
types.....	6
ionic-heated.....	6
resistor.....	6
directly heated.....	6
drive.....	6
follow.....	6
indirectly heated.....	6
remote-cutoff.....	6
resistance-coupled.....	6
sharp-cutoff.....	6
sync.....	6
television.....	6
tone-control.....	6
tone-control, circuit.....	6
video.....	6
volume.....	6
volume-expander.....	6
Amplitude Modulation (AM).....	6
AM Tuner.....	6
Anode.....	6
Application Guide for RCA Receiving Tubes.....	6
Arc-Back Limit.....	6
Audio Control Unit	

Grid-Plate Capacitance.....	7	Noise.....	36, 73
Grid-Plate Transconductance.....	13	Noise Figure.....	37
Half-Wave Rectifier.....	5, 40	Novar.....	10
Harmonic Distortion.....	19, 21, 25	Novar Tube, Parts of.....	74
Heater:		Nuvistor.....	10
cathode.....	4	Nuvistor Tube, Structure of.....	2
cathode bias.....	60	Operation, Typical Values.....	73
cathode connection.....	60	Oscillator:	
resistor.....	59	considerations.....	50
series operation.....	58	multivibrator.....	50
shunt resistor.....	59	relaxation.....	50
supply voltage.....	58	synchronizing.....	51
warm-up time.....	69	Oscilloscope.....	532
Hexode Mixer.....	55	Outlines of Tubes.....	500
High-Fidelity Amplifiers.....	26, 66	Output Capacitance.....	73
High-Fidelity, 15-w Audio Amplifier.....	519	Output Circuits:	
High-Fidelity, 30-w Audio Amplifier.....	520	horizontal.....	53
High-Fidelity, 50-w Audio Amplifier.....	521	vertical.....	52
Horizontal Output Circuits.....	53	Output-Coupling Devices.....	66
Hum and Noise Characteristics.....	73	Parallel Operation.....	17, 40
IF Amplifier/Limiter and Ratio Detector.....	517	Peak Inverse Plate Voltage.....	72
Impedance, Input.....	16	Peak Plate Current.....	71
Input Capacitance.....	73	Peak-to-Peak Voltage.....	9, 54
Instantaneous Peak Voltage.....	72	Pentagrid Mixer.....	55
Intercommunication Set.....	530	Pentode Considerations.....	8
Interelectrode Capacitances.....	7, 73	Phase Inverter.....	33
Intermediate Frequency, Production of.....	54	Phonograph Amplifier.....	524
Interpretation of Tube Data.....	69	Phonograph and Tape Preamplifiers.....	35
Inverse Feedback:		Picture Tube:	
constant-current type.....	29	basin diagrams.....	486
constant-voltage type.....	28	characteristics chart.....	484
Key: Basing Diagrams.....	Inside Back Cover	corona considerations.....	68
Kinescopes.....	10	deflection.....	10
Limiters.....	36	dust considerations.....	68
Load:		essential elements.....	10
resistance.....	20	handling precautions.....	68
resistance line.....	18, 23	high-voltage considerations.....	68
Low-Distortion preamplifier.....	527	humidity considerations.....	68
Luminance Amplifier.....	38	safety considerations.....	68
structure.....	10	screen.....	10
x-ray radiation precautions.....	68	structure.....	10
Maximum Ratings.....	69	x-ray radiation precautions.....	68
considerations.....	6	Plate:	
interference from.....	66	current.....	5
load.....	13	dissipation.....	70
microphone and Phonograph Amplifier.....	525	efficiency.....	13
Miniature Tube, Structure of.....	82	load.....	20
Mixer:		resistance.....	12
audio.....	524	resistance supply.....	60
hexode.....	55	Plate-Cathode Capacitance.....	7, 73
pentagrid.....	55	Portable Superheterodyne Receiver.....	506
Modulated Wave.....	42, 45	Receiver.....	507
Modulation.....	42	Power Output:	
Modulation-Distortion.....	16, 62	calculations.....	18, 20, 21, 24
Multi-Electrode and Multi-Unit Tubes.....	9	test.....	489
Multiplex Adapter for FM Stereo.....	518	Power Sensitivity.....	13
Multivibrator.....	50	Power Supply.....	66, 531
Mutual Conductance (see Transconductance)		Preamplifier for Amateur Receiver.....	526
		Preamplifier for Ceramic Phonograph Pickup.....	527

Preamplifier for Magnetic Phonograph Pickup.....	526	Symbols Used in Resistance-Coupled Amplifier Charts.....	492
Preamplifiers, Phonograph and Tape.....	35	Sync Circuits.....	39
Push-Pull Operation.....	17, 20	Synchromode.....	51
Radio-Frequency:		Tables and Charts (see Charts and Tables)	
amplifier.....	14, 36	Technical Data for Tube Types.....	83
filter.....	65	Television Picture Tubes.....	10
Ratings:		Television RF Amplifiers.....	36
absolute-maximum system.....	69	Television Sync Circuits.....	39
design-center system.....	69	Testing Electron Tubes.....	487
design-maximum system.....	69	Tetrode Considerations.....	7
Ratio Detector.....	46, 517	Three-Stages IF Amplifier/Limiter and Ratio Detector.....	517
Reading List.....	544	Tone-Control Amplifier Stage.....	528
Receiving Tube Chart.....	75	Tone Control.....	34
Rectifiers:		Transconductance.....	512
full-wave.....	5, 40	conversion.....	13
half-wave.....	5, 40	grid-plate.....	13
ionic-heated cathode.....	6	test.....	488
parallel operation of.....	40	TRF AM Tuner.....	515
plate-characteristics curves.....	73	Triode Considerations.....	6
voltage doubler.....	41	Tube.....	
Relaxation Oscillator.....	50	outlines, interpretation of.....	500
Remote-Cutoff Tubes.....	15, 50	ratings, interpretation of.....	69
Resistance-Coupled Amplifier.....	15, 491	tester requirements.....	489
Resistance-Coupled Amplifier.....	33	Tube Types, Technical Data.....	83
Resistor:		Tuner:	
cathode (self-biasing).....	61	FM.....	516
center tap.....	60	TRF AM.....	515
filament.....	59	Tuning Indicators.....	49
filter.....	65	Twin diode—triode.....	9, 43
grid.....	15	Two-Channel Audio Mixer.....	524
plate load.....	20, 21	Two-Channel Stereophonic Amplifier.....	522, 523
screen-grid.....	63, 70	Two-Stage Input Amplifier, Cathode-Follower (Low-Impedance) Output.....	528
Saturation Current.....	5	Typical Operation Values.....	73
Screen Grid (Grid No. 2):		Interpretation of.....	73
considerations.....	7	Vertical Output Circuits.....	52
input.....	70	Video Amplifiers.....	37
voltage supply.....	63	Voltage:	
Secondary Electrons.....	8, 9	amplification, class A.....	14
Secondary Emission.....	8	doubler rectifier.....	41
Self Bias (cathode bias).....	60	peak heater-cathode.....	71
Shielding.....	64	peak inverse plate.....	72
Short-Circuit Test.....	487	supply.....	58
Signal Generator.....	534	Voltage Doubler.....	41
Signal-to-Noise Ratio.....	37	Volt-Ohm Meter.....	535
Space Charge.....	5, 9	Volume Control:	
Static Characteristics.....	12	automatic (AVC).....	46
Stereo Circuits.....	518, 522, 523	by grid-voltage variation.....	62
Superheterodyne Receiver:		by screen-grid-voltage variation.....	64
ac/dc.....	509	delayed automatic (DAYC).....	47
ac-operated.....	508	Volume Compressor and Expander.....	32
portable.....	506	Zero-Bias Operation.....	60
portable 3-way.....	507		
Superegenerative Receiver.....	511		
Suppressor Grid (Grid No. 3).....	8		

RCA Technical Publications

on Electron Tubes, Semiconductor Products, Batteries, and Test and Measuring Equipment

Copies of the publications listed below may be obtained from your RCA distributor or from Commercial Engineering, Radio Corporation of America, Harrison, N. J.

Electron Tubes

● **RCA ELECTRON TUBE HANDBOOK**—HB-3. Five binders, each 7 $\frac{1}{2}$ " L x 5 $\frac{1}{2}$ " W x 2 $\frac{1}{8}$ " D, having gold-imprinted black covers. The "bible" of the industry—contains over 5000 pages of loose-leaf data and curves on RCA receiving tubes, transmitting tubes, cathode-ray tubes, picture tubes, photocells, phototubes, camera tubes, ignitrons, vacuum and gas rectifiers, magnetrons, traveling-wave tubes, premium tubes, pencil tubes, and other miscellaneous types for special applications. Available on subscription basis. Price \$20.00* including service for first year. Also available with RCA Semiconductor Products Handbook HB-10 at special combination price of \$25.00.* Write to Commercial Engineering for descriptive flyer and order form.

● **RADIOTRON† DESIGNER'S HANDBOOK**—4th Edition (8 $\frac{1}{4}$ " x 5 $\frac{1}{2}$ ")—1500 pages. Comprehensive reference thoroughly covering the design of radio and audio circuits and equipment. Written for the design engineer, student, and experimenter. Contains 1000 illustrations, 2500 references, and cross-referenced index of 7000 entries. Edited by F. Langford-Smith of Amalgamated Wireless Valve Co., Pty., Ltd. in Australia. Price \$7.00.*

● **RCA TRANSMITTING TUBES**—TT-5 (8 $\frac{1}{4}$ " x 5 $\frac{1}{2}$ ")—320 pages. Gives data on over 180 power tubes having plate-

input ratings up to 4 kw and on associated rectifier tubes. Provides basic information on generic types, parts and materials, installation and application, and interpretation of data. Contains circuit diagrams for transmitting and industrial applications. Features lie-flat binding. Price \$1.00.*

● **RCA MAGNETRONS AND TRAVELING-WAVE TUBES**—MT-301A (10 $\frac{1}{2}$ " x 8 $\frac{3}{8}$ ")—48 pages. Operating theory for magnetrons and traveling-wave tubes, application considerations, and techniques for measurement of electrical parameters. Price 60 cents.*

● **RCA INTERCHANGEABILITY DIRECTORY OF FOREIGN vs. U.S.A. RECEIVING-TYPE ELECTRON TUBES**—1CE-197B (8 $\frac{3}{8}$ " x 10 $\frac{1}{2}$ ")—8 pages. Covers approximately 800 foreign tube types used principally in AM and FM radios, TV receivers, and audio amplifiers. Indicates U.S.A. direct replacement type or similar type if available. Price 10 cents.*

● **RCA POWER TUBES**—PG101E (10 $\frac{1}{2}$ " x 8 $\frac{3}{8}$ ")—46 pages. Technical information on 200 RCA vacuum power tubes, rectifier tubes, thyratrons, and ignitrons. Includes terminal connections. Price 75 cents.*

● **RCA RECEIVING-TYPE TUBES FOR INDUSTRY AND COMMUNICATIONS**—RIT-104C (10 $\frac{1}{2}$ " x 8 $\frac{3}{8}$ ")—44 pages. Technical information on over 190 RCA "special red" tubes, premium tubes, nuvistors, computer tubes, pencil tubes, glow-discharge tubes, small thyratrons, low-microphonic amplifier tubes, vacuum-gauge tubes, mobile communications tubes, and other special types. Includes

socket-connection diagrams. Price 35 cents.*

● **RCA RECEIVING TUBES AND PICTURE TUBES**—1275-K (10 $\frac{1}{2}$ " x 8 $\frac{3}{8}$ ")—64 pages. New booklet contains classification chart, characteristics chart, and base and envelope connection diagrams on more than 1050 entertainment receiving tubes and picture tubes. Price 50 cents.*

● **RCA INTERCHANGEABILITY DIRECTORY OF INDUSTRIAL-TYPE ELECTRON TUBES**—ID-1020D (10 $\frac{1}{2}$ " x 8 $\frac{3}{8}$ ")—12 pages. Lists more than 1600 basic type designations for 20 classes of industrial tube types; shows the RCA Direct Replacement Type or the RCA Similar Type, when available. Price 35 cents.*

● **RCA NUVISTOR TUBES FOR INDUSTRIAL AND MILITARY APPLICATIONS**—1CE-280 (10 $\frac{7}{8}$ " x 8 $\frac{3}{8}$ ")—16 pages. Describes unique features of nuvistors and includes tabular data, dimensional outlines, curves, terminal diagrams, and socket information. Price 25 cents.*

● **RCA PHOTO AND IMAGE TUBES**—1CE-269 (10 $\frac{1}{2}$ " x 8 $\frac{3}{8}$ ")—32 pages. Includes concise data on RCA multiplier phototubes, gas and vacuum photodiodes, and image-converter tubes. Features recommended multiplier phototubes and image-converter tubes and quick selection charts for phototubes. Includes response curves for photo and image tubes, sockets and shields for phototubes, and dimensional outlines for photo and image tubes. Price 60 cents.*

● **RCA STORAGE AND CATHODE-RAY TUBES**—1CE-270 (10 $\frac{1}{2}$ " x 8 $\frac{3}{8}$ ")—12 pages. Includes technical data on RCA display-storage tubes, computer-storage tubes, scan-converters, radechons, oscillograph-type cathode-ray tubes, and special-purpose kinescopes including monoscopes, transcriber types, monitor types, flying-spot types, projection types, and view-finder types. Gives latest JEDEC "Kelley Chart" and descriptive material on the characteristics of phosphors used in RCA industrial tubes. Price 20 cents.*

● **RCA MICROWAVE TUBES AND PACKAGED SOLID-STATE DEVICES**—1CE-180E (10 $\frac{1}{4}$ " x 8 $\frac{3}{8}$ ")—16 pages. Includes technical data on RCA solid-state

devices, traveling-wave tubes, pencil tubes, integral-cavity pencil tubes, magnetrons, and solenoids for traveling-wave tubes. Single copy free on request.

● **RCA PENCIL TUBES**—1CE-219 (10 $\frac{1}{2}$ " x 8 $\frac{3}{8}$ ")—28 pages. Contains operating theory for pencil tubes, electrical and mechanical circuit-design considerations, environmental considerations, application considerations, and data for commercial types. Price 60 cents.*

● **RCA PHOSPHORS**—TPM-1508A (10 $\frac{1}{2}$ " x 8 $\frac{3}{8}$ ")—20 pages. Contains defining data for over 25 different industrial phosphors, spectral-energy emission curves, persistence curves, and quick-reference classification charts. Price 75 cents.*

● **TECHNICAL BULLETINS**—Authorized information on RCA transmitting tubes and other tubes for communications and industry. Be sure to mention tube-type bulletin desired. Single copy on any type free on request.

● **TV SERVICING**. Bulletin TVS-1080 (10 $\frac{1}{2}$ " x 8 $\frac{3}{8}$ ")—48 pages. Contains articles on TV trouble shooting, TV tuner alignment, and TV circuit analysis by RCA's expert in the field of TV servicing and test equipment—John R. Meagher. Price 35 cents.*

● **TV SERVICING, SUPPLEMENT 1**. Bulletin TVS-1081 (10 $\frac{1}{2}$ " x 8 $\frac{3}{8}$ ")—12-page booklet by John R. Meagher on solving trouble shooting problems in those hard-to-service television receivers known to service technicians as "rough" sets or "dogs." Price 15 cents.*

Semiconductor Products

● **RCA SEMICONDUCTOR PRODUCTS HANDBOOK**—HB-10. Two binders, each 7 $\frac{3}{8}$ " L x 5 $\frac{1}{2}$ " W x 2 $\frac{1}{8}$ " D, having gold-imprinted red covers. Contains over 1000 pages of loose-leaf data and curves on RCA semiconductor devices such as transistors, silicon rectifiers, silicon controlled rectifiers, tunnel diodes, and tunnel rectifiers. Available on subscription basis. Price \$10.00* including service for first year. Also available with RCA Electron Tube Handbook HB-3 at special combination price of \$25.00.* Write to Commercial Engineering for descriptive flyer and order form.

● **RCA TRANSISTOR MANUAL—SC-10** (8 $\frac{3}{8}$ " x 5 $\frac{3}{8}$ ")—304 pages. Contains detailed technical data on RCA semiconductor devices. Easy-to-read text includes information on basic theory, application, and installation of transistors, silicon rectifiers, and semiconductor diodes. Includes circuit diagrams and parts lists for many typical applications. Features lie-flat binding. Price \$1.50.*

● **RCA TUNNEL DIODE MANUAL—TD-30** (8 $\frac{3}{8}$ " x 5 $\frac{3}{8}$ ")—160 pages. Describes the microwave and switching capabilities of tunnel diodes. Contains information on theory and characteristics, and tunnel-diode applications in switching circuits and in microwave oscillator, converter, and amplifier circuits. Includes data for over 40 RCA germanium and gallium arsenide tunnel diodes and tunnel rectifiers. Price \$1.50.*

● **RCA SEMICONDUCTOR PRODUCTS GUIDE—60-S-16R5** (10 $\frac{1}{8}$ " x 8 $\frac{3}{8}$ ")—12 pages. Contains application guide, index, and ratings and characteristics arranged for easy access to RCA's entire line of semiconductor products, as well as digital microcircuits, memory products, and photocells. Single copy free on request.

● **RCA TRANSISTOR REPLACEMENT GUIDE—1L1115** (10 $\frac{1}{8}$ " x 8 $\frac{3}{8}$ ")—36 pages. Contains RCA transistor and rectifier replacement data for more than 1000 portable radio receivers, table radio receivers, tape recorders, and portable equipment of 145 manufacturers. Price 35 cents.*

● **RCA SILICON RECTIFIER INTERCHANGEABILITY DIRECTORY—ICE-229A** (10 $\frac{1}{8}$ " x 8 $\frac{3}{8}$ ")—16 pages. Contains replacement information, ratings, characteristics, and physical dimensions for more than 400 silicon and selenium rectifiers. Price 25 cents.*

● **TRANSISTORIZED VOLTAGE REGULATORS APPLICATION GUIDE—ICE-254** (10 $\frac{1}{8}$ " x 8 $\frac{3}{8}$ ")—12 pages. Discusses transistorized voltage regulators of the series and shunt types. Included are design considerations, step-by-step design procedures, and the solutions to sample design problems. An appendix contains the derivation of design equations. Price

25 cents.*

● **RCA SILICON POWER TRANSISTORS APPLICATION GUIDE—ICE-215** (10 $\frac{1}{8}$ " x 8 $\frac{3}{8}$ ")—28 pages. Describes outstanding features of RCA silicon power transistors and their use in many critical industrial and military applications. Includes construction details, discussion of voltage ratings, thermal stability conditions, and equivalent circuits for these transistors. Price 50 cents.*

● **RCA SILICON VHF TRANSISTORS APPLICATION GUIDE—ICE-228** (10 $\frac{1}{8}$ " x 8 $\frac{3}{8}$ ")—20 pages. Describes unique capabilities of RCA silicon vhf transistors and their use in critical industrial and military applications up to 300 Mc. Price 50 cents.*

● **TECHNICAL BULLETINS—Authorized information on RCA semiconductor products.** Be sure to mention type-number bulletin desired. Single copy on any type free on request.

Batteries

● **RCA BATTERIES—BAT-134F** (10 $\frac{1}{8}$ " x 8 $\frac{3}{8}$ ")—24 pages. Technical data on 113 Leclanché, alkaline, and mercury-type dry batteries, for radios, industrial applications, flashlights, lanterns, electronic toys, and for photoflash service. Price 35 cents.*

● **RCA BATTERY MANUAL—BDG-111** (10 $\frac{1}{8}$ " x 8 $\frac{3}{8}$ ")—64 pages. Contains information for the designer, application engineer, experimenter, and student on dry cells and batteries: carbon zinc (Leclanché), mercury, and alkaline types. Includes battery theory and applications, detailed electrical and mechanical characteristics, a classification chart, dimensional outlines, and terminal connections for each battery type. Price 50 cents.*

● **RCA ALKALINE BATTERIES—ICE-237** (10 $\frac{1}{8}$ " x 8 $\frac{3}{8}$ ")—2 pages. Contains technical data, curves, and dimensional outlines for 4 alkaline batteries in applications having a wide range of current-drain requirements. No recovery period required; batteries have exceptionally long shelf life. Single copy free on request.

Test and Measuring Equipment

INSTRUCTION BOOKLETS— Illustrated instruction booklets, containing specifications, operating and maintenance data, application information, schematic diagrams, and replacement parts lists, are available for all RCA test instruments. Booklets for the following popular instruments are available at the prices indicated. Prices for booklets on other instruments are available on request.

WA-44A (Audio Signal Generator).....\$0.50*
 WA-44C (Audio Oscillator).....1.00*
 WE-93A (Transistor Radio Dynamic Demonstrator Kit).....0.25*
 WE-95A (VOM Dynamic Demonstrator Kit).....0.10*
 WO-33A (Super-Portable Oscilloscope).....1.00*
 WO-88A (5-in. Oscilloscope).....0.50*
 WO-91A (5-in. Oscilloscope).....1.00*
 WR-36A (Dot-Bar Generator).....0.50*
 WR-46A (Video Dot/Crosshatch Generator).....0.75*
 WR-49A (RF Signal Generator) 0.50*
 WR-49B (RF Signal Generator) 1.00*
 WR-50A (RF Signal Generator) 1.00*
 WR-51A (Stereo FM Signal Simulator).....1.00*
 WR-61B (Color-Bar Generator) 1.00*
 WR-64A (Color-Bar/Dot/Crosshatch Generator) 1.00*
 WR-67A (Test-Oscillator).....0.25*
 WR-69A (TV-FM Sweep Generator).....1.00*

WR-70A (RF-IF-VF Marker Adder).....0.75*
 WR-86A (UHF Sweep Generator).....0.50*
 WR-99A (Marker Calibrator) 1.00*
 WV-37B (Radio Battery Tester) 0.25*
 WV-38A (Volt-Ohm-Milliammeter).....0.50*
 WV-65A (VoltOhmystf).....0.25*
 WV-74A (High-Sensitivity AC VTVM).....0.75*
 WV-75A (VoltOhmystf).....0.25*
 WV-76A (AC VTVM).....0.75*
 WV-77A (VoltOhmystf).....0.25*
 WV-77B (VoltOhmystf).....0.25*
 WV-77E (VoltOhmystf).....1.00*
 WV-84C (Ultra-Sensitive DC Microammeter) 0.75*
 WV-95A (VoltOhmystf).....0.25*
 WV-97A (VoltOhmystf).....0.50*
 WV-98B (Senior VoltOhmystf) 1.00*
 WV-98C (Senior VoltOhmystf) 0.50*
 195-A (VoltOhmystf).....0.25*
 WT-100A (Electron-Tube MicroMhoMeter, Ser. No. 1001 and over) 2.00*
 WT-100A (Tube Chart ICE-163).....3.00*
 WT-110A (Automatic Electron-Tube Tester).....1.00*
 WT-110A (ICE-174 Card Punch Data).....0.25*
 WT-110A (ICE-234 Card Punch Data).....1.00*

†Trade Mark Reg. U. S. Pat. Off.

*Prices shown apply in U.S.A. and are subject to change without notice.

*Optional List Price.