

PHILIPS MANUAL

L.F. MILLIVOLTMETER

GM 6012

CONTENTS			
General part	Introduction	7	
	Block diagram	8	
	Technical data	9	
Operating instructions	Installation	10	
	a. Adjustment to the local mains voltage	10	
	b. Earthing	10	
	c. Connection to the mains	11	
	Operation	11	
	a. Switching on	11	
	b. Preliminary deflection	11	
	c. Calibrating	12	
	d. Measuring	12	
	e. When used as an amplifier	13	
	Service data	Description of the working	14
		a. Input attenuator	14
		b. Amplifier	14
c. Meter circuit		15	
d. Calibrating part		15	
e. Supply part		16	
Access to the parts		16	
a. Dismantling of the controls		16	
b. Dismantling of the case		16	
Maintenance			
Survey of the adjustments and the auxiliary apparatus to be used		18	
a. Controls		18	
b. Choice resistors		18	
Checking and adjustment		19	
a. General		19	
b. Supply part		19	
c. Preliminary deflection		19	
d. Sensitivity	20		

e. Attenuators	21
f. Scale check	21
g. Frequency characteristic	21
h. Calibrating voltages	22
j. Mains-voltage dependance	23
k. Total measuring error	23
l. Amplifier	23
m. Interference	24
Replacement of valves and parts	25
Breakdowns	27
List of mechanical parts	28
List of electrical parts	30

List of figures

1. Block diagram	6
2. Front view	9
3. Voltage adaptor	9
4. Calibrating devices	12
5. Removing the knobs	16
6. Removing the cabinet	17
7. Removing the text plate	17
8. Adjusting devices for the sensitivity	20
9. Thermal fuse	25
10. Interior view left side	34
11. Interior view upper side	34
12. Interior view right side	35
13. Interior view back side	35
14. Front view	36
15. Rear view	36
16. Printed circuit A; pre-amplifier	37
17. Printed circuit B; output stage of amplifier	38
18. Printed circuit C; calibrating part	39
19. Printed circuit D; supply part	40
20. Measuring-range switch	41
21. Coaxial connectors	41
22. Switch segment SK1	42
23. Switch segments SK3	42
24. Circuit diagram GM 6012	43

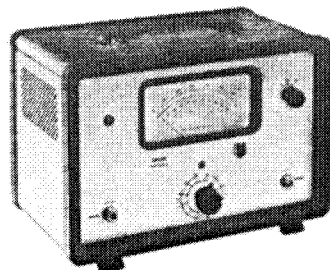

GM 6012

ACCESSORIES

- a. a coaxial 135Ω -cable, at both end provided with an N-connector
- b. a coaxial 135Ω -cable, at one end provided with an N-connector and at the other with two single-pole plugs ($4 \text{ mm } \emptyset$)
- c. a mains cable
- d. an adaptor, on one side provided with an N-connector and on the other side with two sockets for plugs with a diameter of 4 mm.

IMPORTANT !

In correspondence concerning this apparatus please quote the type number and serial number as given on the plate at the back of the apparatus.

INTRODUCTION

The PHILIPS Electronic Voltmeter GM 6012 is suitable for measuring alternating voltages from 0.1 mV up to 300 V in the frequency range from 2 c/s up to 1 Mc/s. The extensive measuring and frequency range makes the apparatus eminently suitable for use in laboratories and electro-technical workshops. The instrument is indispensable for carrying out measurements in the audio and ultrasonic frequency range, for measurements of mechanical vibrations, for measurements on L.F. and M.F. amplifiers and for measurements on carrier-telephony equipment.

The measuring instrument is equipped with scales calibrated both in volts and dB. For calibrating the meter, two voltages are available, viz. a voltage of 30 mV and a voltage of 10 V.

The built-in amplifier can also be used separately.

BLOCK DIAGRAM

The GM 6012 is composed of a wide-band amplifier with 6 stages. The first valve serves as a cathode follower. In this way a high input impedance is obtained, so that the circuit to be measured is only slightly loaded. The attenuator consists of three sections which have been coupled mechanically and are switched over by means of measuring-range switch SK3.

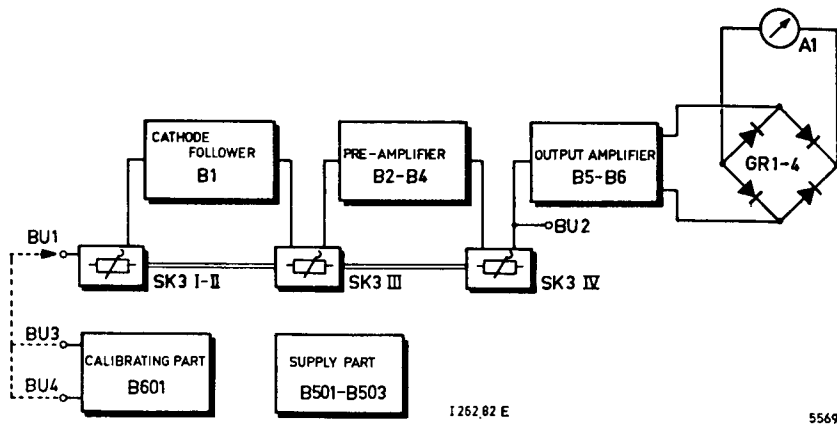

Fig. 1. Block diagram

Mains-voltage fluctuations and ageing of valves have practically no effect on the amplification owing to a strong feed-back. The voltage supplied by the pre-amplifier is applied not only to the output amplifier but also to socket BU2, thus making it possible for the preamplifier to be used separately.

The amplified voltage is rectified in a Graetz circuit and is then applied to the moving-coil instrument A1. To prevent the pointer from vibrating at low frequencies, a very large capacitor (1000 μ F) can be connected across the meter in the range from 2 to 10 c/s. This is effected by means of switch SK1-SK2.

The calibrating part contains a stabilised RC generator producing an a.c. voltage with a frequency of 1000 c/s. The calibrating voltages of 10 V (BU4) and 30 mV (BU3) are taken from this generator via a voltage divider.

TECHNICAL DATA

Properties expressed in numerical values with statement of tolerances are guaranteed. Numerical values without tolerances serve only as orientation and indicate the properties of an average instrument.

Measuring ranges

The instrument has 12 measuring ranges from 1 mV \sim to 300 V \sim (full-scale deflection). These measuring ranges can be adjusted by means of the attenuator switch.

The voltage can be read from scale 0-100 or from scale 0-300. The meter has also a scale calibration in dB.

The positions of the attenuator switch correspond with steps of 10 dB. The scale being calibrated from -20 to + 2 dB, the ranges overlap each other. The level of 0 dB has been chosen at 1 mV in 600 Ω (0.775 V).

	Position of the attenuator		Measuring range in dB
	V	dB	
	1 mV	- 60	- 80 to - 58
	3 mV	- 50	- 70 to - 48
	10 mV	- 40	- 60 to - 38
	30 mV	- 30	- 50 to - 28
	100 mV	- 20	- 40 to - 18
	300 mV	- 10	- 30 to - 8
	1 V	0	- 20 to + 2
	3 V	+ 10	- 10 to + 12
	10 V	+ 20	0 to + 22
	30 V	+ 30	+ 10 to + 32
	100 V	+ 40	+ 20 to + 42
	300 V	+ 50	+ 30 to + 52

Total measuring error (after calibration) for 2 c/s - 5 c/s $\leq 5 \%$
for 5 c/s - 100 kc/s $\leq 2.5 \%$
for 100 kc/s - 1 Mc/s $\leq 5 \%$

Preliminary deflection If the apparatus is earthed and the input short-circuited, the preliminary deflection is smaller than $100 \mu\text{V}$ in position "1 mV" of the measuring-range switch.

Input impedance	Measuring ranges		
	Measuring ranges	Input capacitance	Input resistance
	1 mV - 3 V	20 pF	4 M Ω
	10 V - 300 V	10 pF	10 M Ω

Effect of mains-voltage deviations A deviation $\pm 5 \%$ gives rise to an additional measuring error of maximum 0,5 % after recalibration.

Calibrating voltages For calibrating the voltmeter, two sinusoidal voltages of 30 mV and 10 V (frequency 1000 c/s) are available. These calibrating voltages are not intended for the calibration of other apparatus.

Maximum permissible voltage 300 V in all measuring ranges.

Interference If measurements are taken at frequencies which are practically equal to the mains frequency or a multiple of it (up to 300 c/s), interference may occur as a result

of which the reading may vary by maximum mV.

If used as an amplifier The amplification factor is 50-70.

Supply The apparatus is suitable for connection to a.c. mains of 110, 125, 145, 220 and 245 V (mains frequency 40-100 c/s). At mains frequencies lower than 50 c/s, the mains voltage may not exceed the nominal value. The power consumption is 45 W.

Dimensions Width 35 cm; height 27 cm; depth 21 cm; including feet, controls and handgrip.

Weight 10.5 kg.

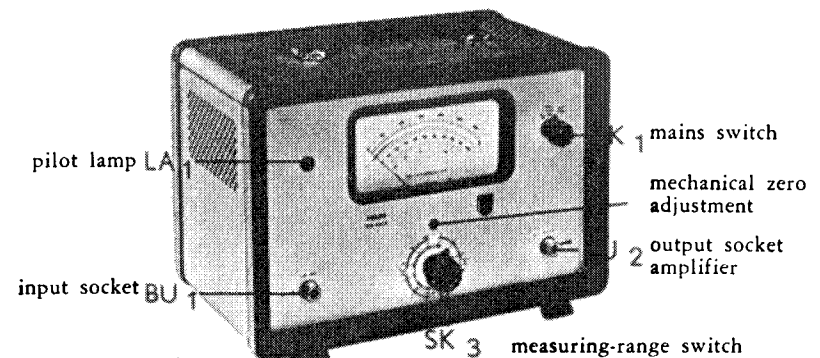

Fig. 2. Front view

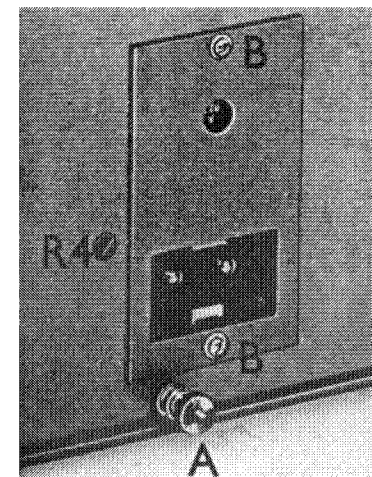

Fig. 3

INSTALLATION

a. Adjustment to the local mains voltage

The apparatus can be adjusted to mains voltages of 110, 125, 145, 200, 220 and 245 V by means of a voltage adaptor. The adjusted value can be read through the circular opening in the rear panel of the apparatus (see Fig.3). When the apparatus is to be adjusted to another mains voltage, one must proceed as follows:

1. Loosen screws "B" and remove the cover plate of the voltage adaptor.
2. Pull out the adaptor a little, turn it until the required voltage is in top position and then push it in again.
3. Refit the cover plate.

b. Earthing

Before connecting the apparatus to the mains, it must be earthed in accordance with the local regulations. Earthing is effected via the earthing screw "A" at the back of the apparatus (see Fig. 3; the earth lead should be as short as possible). If the apparatus is equipped with a three-core mains cable fitted with a plug with rim-earthing, the earth connection can also be established via the mains cable. For measurements of low voltages or for measurements at high frequencies, earthing via the mains cable is not advisable, however, as considerable measuring errors may occur. If the circuit to be measured is already earthed, the voltmeter is earthed via the screening of the measuring cable. In this case the earthing of the GM 6012 via the earth screw should be disconnected.

c. Connection to the mains

1. Check whether the voltage adaptor has been adjusted to the right value.
2. Earth the apparatus.
3. Set switch SK1-SK2 at position "0".
4. Connect the apparatus to the mains via the mains cable supplied.
5. Check whether the pointer of the meter points to "0". If necessary, the pointer can be set at "0" by means of the black screw at the front (mechanical zero adjustment, see Fig.2).

OPERATION

For the functions of controls and connecting sockets, see Figs. 2-4.

a. Switching on

The apparatus is switched on by setting switch SK1-SK2 at position "10 Hz - 1 MHz". The pilot lamp at the front now lights up. In approximately 5 minutes the valves have reached their working temperature and the apparatus is now ready for use.

b. Preliminary deflection

If measuring-range switch SK3 has been set at position "1 mV" and if the input has been short-circuited, the preliminary deflection must be smaller than 0.1 mV. If this is not the case, one should proceed as follows:

1. Remove the short-circuit of the input.
2. Adjust the preliminary deflection to the minimum value by means of the potentiometer R56 ("0") at the right-hand side panel (screw adjustment).
3. If the preliminary deflection continues to be larger than 0.1 mV, in spite of the fact that the apparatus is **properly earthed**, it may help to reverse the plug in the mains socket; see also chapter "*Checking and adjustment*" (page 19).

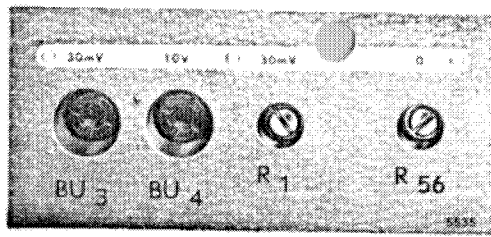

Fig. 4. Calibrating devices

c. Calibrating

For this purpose two stabilized calibrating voltages of 30 mV and 10 V with a frequency of 1000 c/s are available on BU3 ("30 mV") and BU4 ("10 V") respectively. These voltages are exclusively intended for the calibration of the apparatus.

When calibrating, proceed as follows:

1. Set measuring-range switch SK3 at position "30 mV".
2. Connect socket BU1 ("1 mV-300 V") to socket BU3 ("30 mV", on the right-hand side panel).
3. Adjust the meter deflection to exactly 300 calibrations (scale 0-300) by means of potentiometer R1 ("30 mV") on the right-hand side panel (screw adjustment).
4. Then set measuring-range switch SK3 at position "10 V" and connect socket BU1 ("1 mV - 300 V") to socket BU4 ("10 V", on the right-hand side panel).
5. Check whether the meter reading is exactly 100 calibrations (scale 0-100). If necessary, adjust the deflection by means of potentiometer R4 (on the rear panel, see Fig. 3).

d. Measuring

Measuring takes place with switch SK1-SK2 at position "2 Hz-1MHz" or "10 Hz-1 MHz".

At position "2 Hz-1 MHz", a large capacitor is connected across the meter to prevent the pointer from vibrating during measurements at low frequencies

(between 2 and 10 c/s). This capacitor slows the motion of the pointer, however. It is therefore advisable to set switch SK1-SK2 at position "10 Hz - 1 MHz" for measurements at higher frequencies.

The voltage to be measured is connected to socket BU1 ("1 mV-300 V"), the measuring-range switch SK3 being set at position "300 V". This switch is then turned anti-clockwise until the meter deflection is clearly readable. Dependent on the position of SK3, the measured value is read from scale 0-100 or from scale 0-300. Care should be taken that the maximum permissible voltage of 300 V is not exceeded.

Note: Although the meter deflection is proportional to the mean value of the full-wave rectified voltage, the scale of the meter has been calibrated in r.m.s. value for measurements of purely sinusoidal voltages. It is therefore impossible to measure the r.m.s. value of non-sinusoidal voltages with the GM 6012. On the other hand, however, it is possible to use the meter for comparative measurements of non-sinusoidal voltages of the same shape. The value found in this way may deviate from that indicated by, for example, a thermo-couple voltmeter which measures the actual r.m.s. value.

e. When used as amplifier

The output of the pre-amplifier is connected not only to the output amplifier but also to socket BU2, so that the voltmeter can also be used as an amplifier. In that case socket BU1 is the input and socket BU2 the output. The measuring-range switch should then be set at position "1 mV". The amplification factor is 50-70. As only a part of the amplifier is used, nothing can be guaranteed about the frequency characteristic.

SERVICE DATA

DESCRIPTION OF THE WORKING

a. Input attenuator

This attenuator (R2, R3, R4, R11, C1 and C2) is switched on when the measuring-range switch SK3 is set at position "10 V" or higher and gives a fixed attenuation of 100 X.

With trimmer C1 the attenuator can be so adjusted that it is frequency independent. R4 serves for the correct adjustment of the attenuator (100 X).

b. Amplifier

Valves B1 to B6 inclusive form an a.c. amplifier where valve B1 has been connected as a cathode follower. This made it possible to keep ohmic resistance of the attenuator (R5 to R9 inclusive), connected in parallel to R14 and R15, low so that this attenuator is practically frequency independent. B4 is also connected as a cathode follower and is also followed by a low-ohmic attenuator (R35 to R39 inclusive).

As C5 and C10 are electrolytic capacitors, C6 and C12 have been fitted to block the d.c. voltage produced by the leakage current.

The output of the pre-amplifier is led outside (BU2) via C13, so that the pre-amplifier of the valve voltmeter can also be used as a separate amplifier. The amplification is then 50-70 X (measuring-range switch SK3 at position "1 mV").

Frequency characteristic

The RC elements effect the amplification for the low frequencies. Owing to wiring and parallel capacitances the amplification decreases at high frequencies. To compensate this, the following measures have been taken:

1. The leakage resistors R10 and R30 have been connected to a tap of the cathode resistance of B1 and B4 respectively. This causes the input impedance of these valves to become much greater (approx. 7.5 M Ω).
2. The cathode resistors have not been de-coupled so that current feed-back is obtained.

3. The voltage amplification at low frequencies increases owing to RC elements R13-C4 and R18-C7.
4. The anode of B6 is fed back to the cathode of B5 via GR1-GR4 and C20 (current feed-back).
5. The cathode of B4 is fed back to the cathode of B2 via R25 and R24/C11 (voltage feed-back). The frequency characteristic can be corrected by means of C11.
6. For the very low frequencies the time constant of the RC element at the output of B6 has been made high by applying large capacitors (C16, C17 and C18).

c. Meter circuit

The meter circuit consists of a moving-coil instrument of 200 μ A (A1) included in a Graetz circuit of 4 germanium diodes (GR1 to GR4 inclusive). The sensitivity of the meter can be adjusted by means of potentiometer R1. To prevent the pointer from oscillating when measuring voltages with very low frequencies, a large capacitor is connected in parallel to the meter at position "2 Hz-1 MHz" of SK1-SK2. In this position C16 is also connected in parallel to C17/C18 (see point b.6). This slows the motion of the pointer, however.

The non-decoupled cathode resistor of B6 gives a high internal resistance so that the scale of the meter could be made linear.

d. Calibrating part

Valve B601 has been connected as an RC generator. The dimensions of the phase-shifting elements (C603-R615, C605-R614, C604-R613) have been so chosen that the generator produces an a.c. voltage with a frequency of about 1 kc/s. This voltage is applied to a voltage divider (R601 to R605 inclusive) and is then stabilized by the valve section B601' connected as a diode detector. The stabilizing effect takes place as follows (Fig.24):

The cathode of B601' has a positive potential supplied by the voltage divider R606 and R607. When the positive peaks of the anode voltage V_a of B601 are higher than this cathode voltage V_k , B601' will become conductive because the anode voltage of this valve follows the anode voltage of B601 via C602. C602 is now charged by the diode. A part of the voltage across C602 is applied to C606, so that the oscillator valve is adjusted slightly more negative. The anode a.c. voltage decreases and is consequently stabilized. The negative pre-voltage of B601 is practically equal to $V_a\sqrt{2}-V_k$ because the RC time (R609-C606) is great and the capacitor load can only be discharged slowly.

A voltage of 10 V and 30 mV can be taken from sockets BU4 and BU3 respectively.

The voltage on BU4 is set to 10 V by means of R608 (parallel to R606 or R607) and the voltage on BU3 is set to 30 mV by means of R605 (parallel to R604).

e. Supply part

The supply voltages for the valves are kept constant by a stabilizing circuit with B502 as gating valve, B502' as control valve and B503 as reference valve. The supply voltage of 170 V is set to the correct value by means of R510. R56 serves to eliminate a possible preliminary deflection of the pointer due to hum voltages (accessible from the outside). The supply transformer is protected against too high temperatures by the thermal fuse VL1.

ACCESS TO THE PARTS

a. Dismantling of the controls

1. Remove cap "A".
2. Loosen screw "B" slightly and tap it gently while holding the knob.

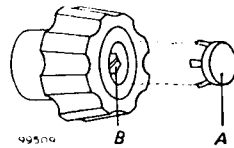

Fig. 5

The knob can now be removed from the spindle.

b. Dismantling of the case

The case has been so designed that the top, bottom, rear and side plates can be removed separately.

1. Rear plate

The rear plate can be taken off after loosening the 7 screws "A" (Fig. 15) and after removing the earth terminal.

2. Bottom plate and side plates

- a. Loosen the 2 screws "B" (Fig. 15) by which the plates are fixed.
- b. Push the panel slightly forward and lift it from the frame (see fig. 6).

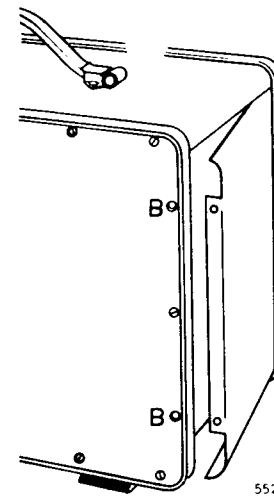

Fig. 6

3. Top plate

- a. Detach the carrying handle by loosening the 4 screws of the fixing brackets
- b. Loosen the 2 screws "C" (Fig. 15).
- c. Push the plate slightly forward and lift it from the frame.

4. Front panel

- a. Remove the controls
- b. Remove top and bottom plate
- c. Loosen the 6 bolts "C" (Fig. 7).

The front panel can now be removed.

5. Text plate

- a. Remove the front panel as indicated in point 4.
- b. Detach the text plate from this panel by removing the 6 distance pieces "D" and the 6 bolts and springs "E" (Fig. 7).

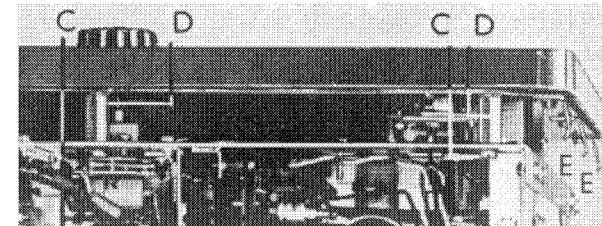

Fig. 7. Removing the text plate

MAINTENANCE

The top plate as well as the side plates are made of aluminium on which a plastic coating has been applied. After having been dismantled, there is no objection against cleaning these plates with water and soap.

SURVEY OF THE ADJUSTMENTS AND THE AUXILIARY APPARATUS TO BE USED

a. Controls

the adjustment refers to :	control	measuring apparatus	recommended PHILIPS measuring apparatus	page
hum compensation (preliminary deflection)	R56	none		19
sensitivity	R1	L.F.generator + valve voltmeter	GM 2317+ GM 6012 or GM 6014	20
sensitivity (measuring range "10 V" and higher")	R4, C1	L.F.generator + valve voltmeter (calibrated) + amplifier	GM 2317 + GM 6012 or GM 6014 + GM 4532	20
frequency characteristic	C11, C19	L.F.generator + L.F.generator + H.F.generator + valve voltmeter	ZV 2312 (Z9 060 69) + GM 2317+ GM 2883+ GM 6012	

b. Choice resistors

the adjustment refers to:	choice resistor	measuring apparatus	recommended PHILIPS measuring apparatus	page
supply voltage	R510	multimeter	P 817 00	19
sensitivity (measuring range "10 mV")	R54	L.F.generator + valve voltmeter (calibrated)	GM 2317 + GM 6012 or GM 6014	20
sensitivity (measuring range "30 mV")	R36	L.F.generator + valve voltmeter (calibrated)	GM 2317 + GM 6012 or GM 6014	20
calibrating voltages "30 mV" "10 V"	R605 R608	L.F.generator + valve voltmeter (calibrated)	GM 2317 + GM 6014 or GM 6014	23

CHECKING AND ADJUSTMENT

The tolerances mentioned below are factory tolerances which are valid only when the apparatus must be readjusted.

a. General

In the tables on page 18 all adjustment controls and choice resistors with a description of their function and the required apparatus are mentioned. The position of the adjustment controls and choice resistors are indicated in the figures 2, 8 and 10-20.

If the apparatus must be re-adjusted (e.g. when all valves have been replaced), the following checking measurements and the consequent adjustments should, at any rate, be carried out.

1. supply voltage, see b
2. zero adjustment and preliminary deflection, see c
3. sensitivity, see d
4. attenuation accuracy, see e
5. frequency characteristic, see g
6. calibrating voltages, see h
7. total measuring error, see k.

b. Supply part

The d.c. voltage across C503 should lie between 165 and 175 V. This voltage can be adjusted by selecting the correct value for R510. The ripple voltage across C503 should be < 10 mV, also at mains voltage deviations of $\pm 5\%$. The stabilizer valve B503 should still ignite at a mains voltage drop of 10%. If this is not the case, the valve must be replaced.

c. Preliminary deflection

If the apparatus is switched off, the pointer should stand at "0". If necessary, adjust by means of the mechanical zero adjustment at the front of the apparatus. Set switch SK1-SK2 at position "10 Hz-1 MHz" and the measuring-range switch SK3 in position "1 mV". Adjust the scale deflection at minimum by means of potentiometer "0" (R56) (screw-driver adjustment on the right-hand side panel, see Fig. 8).

Connect input socket BU1 to earth. Now the preliminary deflection may not exceed 100 μ V. If the deflection is greater, valve B2 (E 83 F) must be replaced.

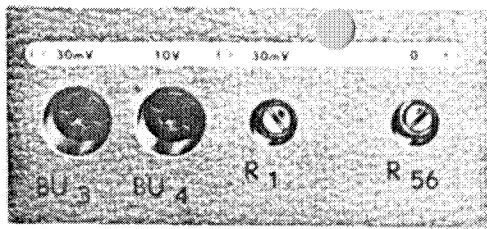

Fig. 8. Adjusting devices for the sensitivity

d. Sensitivity

1. Set switch SK1-SK2 at position "10 Hz-1 MHz".
Set measuring-range switch SK3 at position "10 mV".
Set potentiometer "30 mV" (R1, right-hand side panel) in about middle position.
Connect to the input a sinusoidal calibrating voltage of exactly 10 mV, frequency 10 kc/s.
The meter should now read about 100 scale divisions (if the deviation is considerable, replace R54);
Adjust the meter to exactly 10 mV by means of R1.
2. Set measuring-range switch SK3 at position "30 mV".
Increase the input voltage to exactly 30 mV (10 kc/s).
The meter should now read exactly 300 scale divisions. If necessary, replace R36.
If R36 has been replaced, it is necessary to check the measuring range "10 mV" and to repeat the measurements until both measuring ranges have been adjusted to the correct value by means of R1 and R36.
3. Set measuring-range switch SK3 at position "10 V".
Connect to the input a sinusoidal calibrating voltage of 10 V, with a frequency of 200 c/s.
The meter should now read exactly 10 V. If necessary, adjust by means of potentiometer R4 (at the back of the apparatus).
Increase the frequency of the input voltage to 10 kc/s; keep the amplitude constant.
The meter should still read exactly 10 V.
If this is not the case, adjust by means of C1 (underneath the apparatus)

e. Attenuators

The measuring ranges must be checked with purely sinusoidal calibrating voltages with a frequency of 10 kc/s.

Vi (BU1),	SK3	Meter reading	
		scale 0 - 100	scale 0 - 300
1 mV	1 mV	99 - 101	
3 mV	3 mV		297 - 303
10 mV	10 mV	99 - 101	
30 mV	30 mV		297 - 303
100 mV	100 mV	99 - 101	
300 mV	300 mV		297 - 303
1 V	1 V	99 - 101	
3 V	3 V		297 - 303
10 V	10 V	99 - 101	
30 V	30 V		297 - 303
100 V	100 V	99 - 101	
300 V	300 V		297 - 303

Note: If the L.F.generator GM 2317 is used, the signal can first be amplified by an amplifier (e.g. the GM 4532) as far as input voltages of > 10 V are concerned. The highest voltage range can also be checked at, for instance, 170 V (GM 2317 + GM 4532). The reading should then be between 167 and 173 scale divisions.

f. Scale check

Set measuring-range switch SK3 at position "1 V".	Vi (BU1)	Meter reading
Connect to the input a sinusoidal calibrating voltage of 1 V, 0.8 V, 0.6 V, etc. with a frequency of 10 kc/s.	1 V	100 (ref. point)
The error may not exceed 1.5 % of the full-scale deflection.	0.8 V	78.5 - 81.5
The permissible deviations are given in the table beside.	0.6 V	58.5 - 61.5
	0.4 V	38.5 - 41.5
	0.3 V	28.5 - 31.5
	0.2 V	18.5 - 21.5
	0.1 V	8.5 - 11.5

g. Frequency characteristic

1. Set switch SK1-SK2 at position "2 Hz-1 MHz" and the measuring-range switch SK3 at position "10 mV".

Connect to the input socket an a.c. voltage of such value that the meter reading is exactly 100 scale divisions. Check the characteristic for the following frequencies at a constant input voltage (table 1):

1. frequency Meter reading

10 kc/s	100 (ref.point)
2 c/s *)	97.5 - 102.5
5 c/s	98.5 - 101.5

*) At this frequency the pointer may oscillate 2 % around the scale reading

2. Set switch SK1-SK2 at position "10 Hz-1 MHz".

Check the frequency characteristic at the following frequencies (table 2):

When switching SK1-SK2 from position "10 Hz-1 MHz" to position "2 Hz-1 MHz", the reading may not change more than 3 % at a frequency of 10 kc/s.

2. frequency Meter reading

10 kc/s	100 (ref.point)
10 c/s	98 - 102
100 kc/s	99 - 101
1 Mc/s **)	98 - 102

**) If necessary, adjust C11 and C19 until the scale reading lies within the tolerance.

3. Set switch SK1 at position "10 Hz-1 MHz" and SK3 at position "30 mV".

Check the frequency characteristic at the following frequencies on 1/3 of the scale. (table 3):

3. frequency Meter reading (scale 0-300)

10 kc/s	100 (ref.point)
10 c/s	94 - 106
100 kc/s	97 - 103
1 Mc/s ***)	94 - 106

***) If the reading exceeds the permissible tolerance, it can be adjusted by means of C19. In that case the frequency characteristic at a frequency of 1 Mc/s referred to in point 2, must be checked again after which checking according to point 3 can be resumed.

4. Set measuring-range switch SK3 at position "10 V" (SK1-SK2 at "10 Hz-1MHz"). Increase the input signal again until full-scale deflection is obtained (100 scale divisions) and check the frequency characteristic according to points 1 and 2.

h. Calibration voltages

1. Set switch SK1-SK2 at position "10 Hz-1 MHz" and the measuring-range switch SK3 at position "10 V".

Connect to the input a sinusoidal a.c. voltage of exactly 10 V with a frequency of about 10 kc/s.

The meter should now read exactly 100 scale divisions. If necessary, adjust by means of R1 (at the right-hand side panel, see Fig. 8).

Remove the input voltage and connect BU1 to BU4.

The meter reading should now again be 100 scale divisions ± 0.3 %. If this is not the case, another value should be mounted for R608.

2. Set measuring range switch SK3 at position "30 mV". Connect to the input a purely sinusoidal a.c. voltage of exactly 30 mV with a frequency of about 10 kc/s.

The meter should now read exactly 300 scale divisions. If necessary, adjust by means of R1 (on the right-hand side panel, see Fig. 8).

Remove the input voltage and connect BU1 to BU3.

The meter reading should now again be 300 scale division ± 0.3 %.

If this is not the case, another value should be mounted for R605.

j. Mains-voltage dependence

1. Connect the apparatus to a variable transformer.

Set measuring-range switch SK3 at position "10 mV".

Connect such an a.c. voltage to the input (frequency 10 kc/s) that the meter reads 100 scale divisions.

Increase the mains voltage with 5 %. After 1 minute the meter should read between 100 and 101 scale divisions.

Reduce the mains voltage with 5%. After 1 minute, the meter should read between 99 and 100 scale divisions.

2. The calibrating voltages can be checked in the same manner. 1 minute after the mains voltage has been changed with 5 % the voltage on BU3 must be > 29.85 mV but < 30.15 mV, while the voltage on BU4 must be > 9.95 V but < 10.05 V.

k. Total measuring error

Calibrate the apparatus according to point h.

Check all measuring ranges at full-scale deflection by means of purely sinusoidal a.c. voltages at the following frequencies:

Frequency	Meter reading	
	scale 0 - 100	scale 0 - 300
5 c/s	98 - 102	294 - 306
5 c/s - 100 kc/s	98.5 - 101.5	295.5 - 304.5
2 c/s - 5 c/s 100 kc/s - 1 Mc/s	97 - 103	291 - 309

l. Amplifier

Set measuring-range switch SK3 at position "1 mV".

Connect to the input socket a sinusoidal voltage of 1 mV with a frequency of 10 kc/s.

The voltage measured on connecting socket BU2 should now be between 50-70 mV.

m. Interference

Set measuring-range switch SK3 at position "3 mV".

Connect such an a.c. voltage to input socket BU1 that the meter shows a deflection of 300 scale divisions. The frequency of this a.c. voltage should be equal to the mains frequency or a multiple of it.

The meter reading may now vary between 290 and 310 scale divisions (in total 0.2 mV).

REPLACEMENT OF VALVES AND PARTS

The valves or parts used in the apparatus are not selected. After replacing valves or parts, it may be necessary to re-adjust the relevant circuit. For this, see chapter "Checking and adjustment", page 19. While replacing valves or parts the apparatus should be switched off. For the access of parts, see chapter "Access to the parts", page 16.

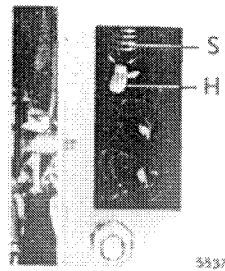

Fig. 9. Thermal fuse

a. Thermal fuse

This fuse blows when the temperature of the supply transformer becomes too high. When this fuse has blown the cause should be traced before the fuse is replaced.

The new fuse should be attached to spring "S" and should then be pulled over hook "H" (see Fig. 9).

b. Supply transformer

The supply transformer can be removed by unscrewing the 3 nuts by which the transformer is fixed to the support at the rear and by loosening the various connections of the transformer.

c. Measuring instrument and coaxial plug sockets

These can be replaced after the control knobs and the front panel have been removed (see chapter "Access to the parts", page 20).

d. Moving-coil system

The moving-coil systems supplied by the Central Service Department have a resistance of $440 \Omega \pm 10 \%$. After replacing the moving-coil system in the magnet, the meter must be adjusted in the apparatus by means of the calibrating voltage.

For this purpose the measuring-range switch must be set at position "10 V" and BU1 should be connected to BU4. The meter reading is adjusted to exactly 10 V by means of R1 (on the right-hand side panel).

If the correct reading lies outside the control range of R1, another value should be mounted for R54.

Furthermore, the scale curve should be checked (see chapter "Checking and adjustment", point f).

e. Valves

Valve B501 and the germanium diodes GR1-GR4 can immediately be replaced. B503 and B601 should be aged for 200 hours. The other valves should be aged for 100 hours.

Aging is effected by connecting the valves as a diode (connect grids, g1, g2 and g3 of the pentodes to the anode a, and grid g of the triodes to anode a). The anode voltage is so selected that at normal heater current, the rest current through the valve is 1/6 of the maximum permissible cathode current.

The rest current for the various valves is as follows:

EF 80	– 2.5 mA	PCL 82 (triode)	– 2.5 mA
E 83 F	– 2.5 mA	PCL 82 (pentode)	– 8 mA
85 Az	– 1.5 mA	E 80 CF (triode)	– 3 mA
		E 80 CF (pentode)	– 3 mA

After having replaced old valves by new valves which have been aged, it is advisable to carry out the checking measurements mentioned in the table below (except for the B601, this can be done by using the calibrating voltages present in the apparatus):

B 205	chapter "Checking and adjustment" point b, j
B1, B6	chapter "Checking and adjustment" point d, g
B2	chapter "Checking and adjustment" point c
B601	chapter "Checking and adjustment" point h

BREAKDOWNS

The arrangement of the valves and the parts is shown in figures 10 up to 15. To facilitate the tracing of breakdown the principal voltages have been indicated in the figures of the printed-wiring plates and the circuit diagram, Figs.16–19 and 24.

The values indicated serve only as a guidance and have been measured with respect to earth by means of valve voltmeter GM 6008.

The values given in the table in the circuit diagram refer to the voltages across the transformer windings at no load.

To make rapid tracing of breakdowns possible, one should become familiar with the working of the apparatus (see chapter "*Description of the working*", page 14).

The Philips Service Organization is always at your service.

Some causes of breakdown

1. The pilot lamp LA1 does not light up when the apparatus is switched on.
 - a. Check the thermal fuse VL1.
 - b. Check whether the mains voltage is present on the supply transformer.
 - c. Check the pilot lamp LA1.
2. The pointer does not deflect.

Check the valves. The arrangement of the valves is shown in Figs. 10-13. After replacing a valve, the apparatus must be re-calibrated according to chapter "*Checking and adjustment*", point e.

3. The preliminary deflection of the meter is too great.

For this see chapter "*Checking and adjustment*", point c.
4. The deflection is unstable, although no voltage is applied to the input.
 - a. Check whether the apparatus is properly earthed.
 - b. Check whether there is no H.F. generator of high power (e.g. transmitter) in operation in the vicinity of the apparatus.
 - c. Check the valves and if necessary, the valve-base contacts.
 - d. A strongly fluctuating mains voltage also causes instability.

LIST OF MECHANICAL PARTS

Fig.	item	number	description	code number	S
14	1	2	coaxial socket	977/C03	*
14	2	1	side plate (left-hand)	M7 771 06	**
14	3	1	text plate	M7 190 29.2	**
14	4	1	lens (red)	A9 864 21	**
14	5	1	top plate	M7 697 65	**
14	6	1	grip	M7 076 17	**
14	7	2	bracket	E2 742 67	**
14	8	1	knob 22 mm Ø	973/52	*
14	9	1	cap for knob 22 mm Ø	973/D51	**
14	10	1	arrow for knob 22 mm Ø	973/P55	**
14	12	1	correction screw	A9 866 21.0	*
14	13	1	knob 30 mm Ø	973/53	*
14	14	1	cap for knob 30 mm Ø	973/D52	**
14	15	1	arrow for knob 30 mm Ø	973/P51	**
14	16	4	rubber support	P7 655 14	**
15	17	2	plug socket	979/11	*
15	18	1	text plate	M7 191 00	**
15	19	1	side plate (right-hand)	M7 771 07	**
15	20	1	mains connection	978/M2X19	*
13	21	1	mains-voltage adaptor	M7 737 11	*
13	22	1	mains switch	B1 590 33	*
13	23	1	valve holder, Min.	976/PW7 × 10	*
13	24	1	pilot-lamp holder	976/1 9	*
13	25	5	feed through (500 V)	978/D17	*
10	26	9	valve holder, Noval	976/PW9 × 12	*
10	27	4	tension spring	C1 311 51	*
10	28	34	soldering eyelet	A3 320 36	**
11	29	1	protecting cap	977/C02	**
21	30	3	coaxial plug	977/CM04	*
21	31	100 cm	H.F.cable 135Ω (11 mm Ø)	R 209 KA/13AA0	*
21	32	100 cm	H.F.cable 135Ω (6 mm Ø)	R 209 KA/11BB0	*
21	33	1	coaxial plug	978/4 × 65	*

Fig.	item	number	description	codenum.	S
21	34	1	plug pin	M7 340 18	*
21	35	1	banana plug	F 041 AA/01	*
			meter complete	P 829 81	**
			adaptor plug	978/VP01	**

Purpose of the column S

Components not marked

These should be present at the Service-Department in the country concerned or at the customer's who is using the apparatus.

They include:

- nearly all electrical components;
- mechanical parts which are vulnerable, or which are subject to wear.

** Components marked which one star*

These components generally have a long or unlimited service-life, but their presence is essential for the correct working of the apparatus.

Stocking up of a few of these components depends on the following factors:

- the number of apparatus present in the country concerned;
- the necessity of having the apparatus working continuously or not;
- the time of delivery of the components with respect to the import possibilities in the country concerned and the duration of the transport.

*** Components marked with two stars*

These components have a long or unlimited service-life and they are not essential for the correct working of the apparatus. Generally there is not a local stock.

IST OF ELECTRICAL PARTS

Only those components which are not standard are indicated in the principal diagram by means of identification marks shown next to the components.

A key is provided in the diagram so that the order number of a specific component may be determined in the following manner:

e.g.



901/120K

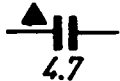

904/4E7

Capacitors

No.	coord. (diagram)	code number	value	tol.	voltage	description
C2*)	A4	905/110E-130E	100 - 130	pF	1 0/0	500 V mica
C4	B1	AC 8308/50 + 50	50	μF		200 V electrolytic
C5	B2	C435DF/H250 + 250	250 + 250	μF		64 V electrolytic
C7	C1	see C4	50	μF		200 V electrolytic
C10	E2	C435DF/H250 + 250	250 + 250	μF		64 V electrolytic
C11	C2	C004FA/6E	6	pF		500 V ceramic (var.)
C16	H1	M7 414 70	6	μF	10 0/0	250 V paper
C19	G2	XU 053 87	25	pF		500 V air trimmer
C20	H2	C435AL/E100	100	μF		16 V electrolytic
C22	H1	M7 414 72	1000	μF		6 V electrolytic
C501	G5	AC 8311/12.5 + 12.5	12.5	μF		500 V electrolytic
C503	G3	911/P8	8	μF		350 V electrolytic
C505	G5	see C501	12.5	μF		500 V electrolytic
C607	B5	910/G25	25	μF		100 V electrolytic

*) The correct value has been fixed when adjusting the apparatus in the factory

Resistors

All resistors are standardized carbon resistors, unless stated otherwise.

no.	coord. (diagram)	code number	value	tol.	power	description
R1	H1	E 199 AA/B13A250E	250	Ω	10 0/0	1 W potentiometer (lin.)
R3	A4	901/180K par. 901/200K	95	kΩ	1 0/0	0.25 W
R4	A4	B8 315 00P/10K	10	kΩ		0.5 W potentiometer (lin.)
R5	B4	901/W18E	18	Ω	0.5 0/0	0.1 W
R6	B4	901/W39E	39	Ω	0.5 0/0	0.1 W
R7	B3	B8 305 23E/123E	123	Ω	0.5 0/0	0.1 W
R8	B3	901/W390E	389	Ω	0.5 0/0	0.1 W
R9	B3	B8 305 23E/1K23	1.23	kΩ	0.5 0/0	0.1 W
R35	E4	B8 305 23E/61E	61	Ω	0.5 0/0	0.1 W
R36*)	E4	901/820E-∞	820	Ω∞	10 0/0	0.5 W
R37	E3	B8 305 23E/130E	130	Ω	0.5 0/0	0.1 W
R38	E3	B8 305 23E/410E	410	Ω	0.5 0/0	0.1 W
R39	E3	B8 305 23E/1K3	1.3	kΩ	0.5 0/0	0.1 W
R54*)	H1	901/47E-100E	47-100	Ω	10 0/0	0.25 W
R56	G5	916/GE300E	300	Ω		0.25 W potentiometer (lin.)
R510*)	H4	901/1M-3M3	1MΩ-3.3	MΩ	10 0/0	0.5 W
R511	G3	E 003 AG/C47K	47	kΩ	5 0/0	1 W
R601	A5	48 123 01/85K	85	kΩ	1 0/0	1.2 W wire-wound
R602	A5	48 123 01/85K	85	kΩ	1 0/0	1.2 W wire-wound
R603	A6	48 123 01/85K	85	kΩ	1 0/0	1.2 W wire-wound
R604	A6	48 761 01/520E	520	Ω	0.5 0/0	0.6 W wire-wound
R605*)	A6	901/10K-39K	10 kΩ - 39	kΩ	10 0/0	0.5 W
R606	A6	48 123 01/100	100	kΩ	1 0/0	1.0 W wire-wound
R607	B6	48 123 01/34K	34	kΩ	1 0/0	1.2 W wire-wound
R608*)	A6-B6	901/220K-4M7	0.22 - 4.7	MΩ	10 0/0	0.5 W

*) The correct value has been fixed when adjusting the apparatus in the factory

Tubes

B1	EF 80	pentode	GR1	OA 73	germanium diode
B2	E 83 F	pentode	GR2	OA 73	germanium diode
B3	EF 80	pentode	GR3	OA 73	germanium diode
B4	EF 80	pentode	GR4	OA 73	germanium diode
B5	EF 80	pentode	LA1	7181 N	pilot lamp 8-10 V; 50 mA
B6	EF 80	pentode			
B501	EZ 80	rectifying valve			
B502	PCL 82	triode-pentode			
B503	85 A 2	diode			
B601	E 80 CF	triode-pentode			

Fuse

VL1	974/T125	thermal fuse
-----	----------	--------------

Transformer

T1	M7 614 74
----	-----------

Fig. 10. Interior view left side

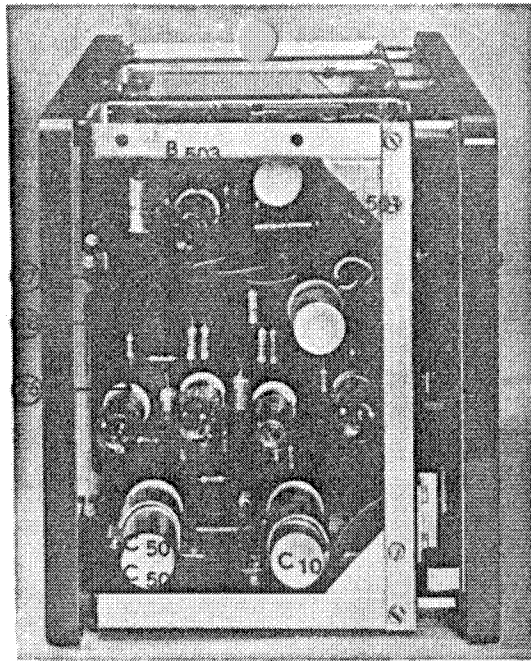
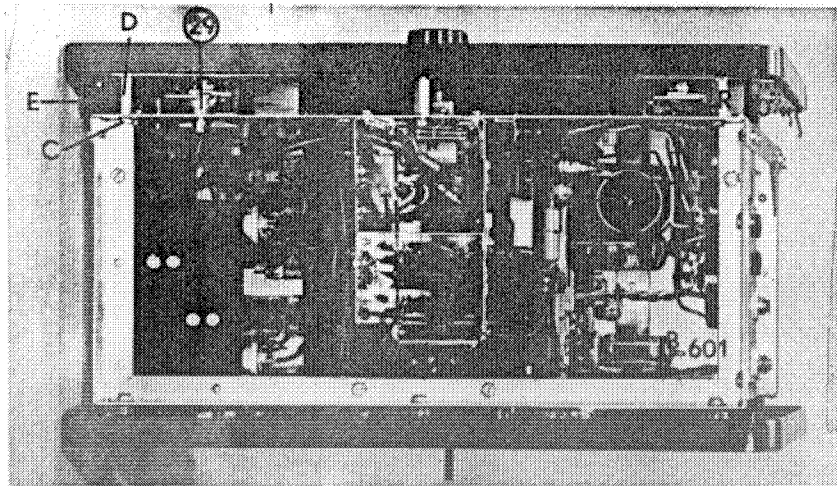
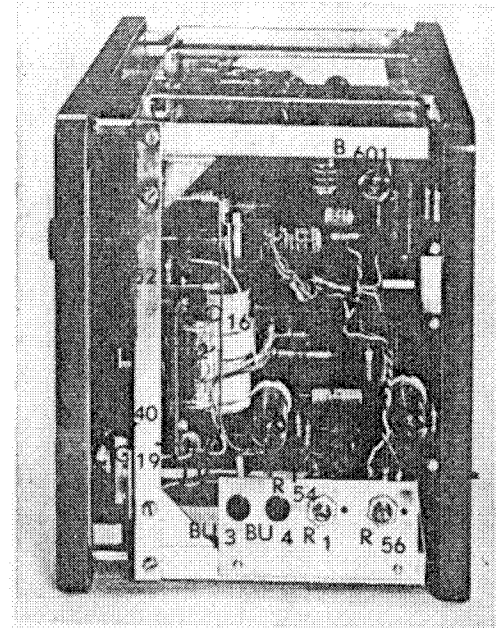

Fig. 11. Interior view upper side



5539



5540

Fig. 12. Interior view right side

Fig. 13. Interior view back side

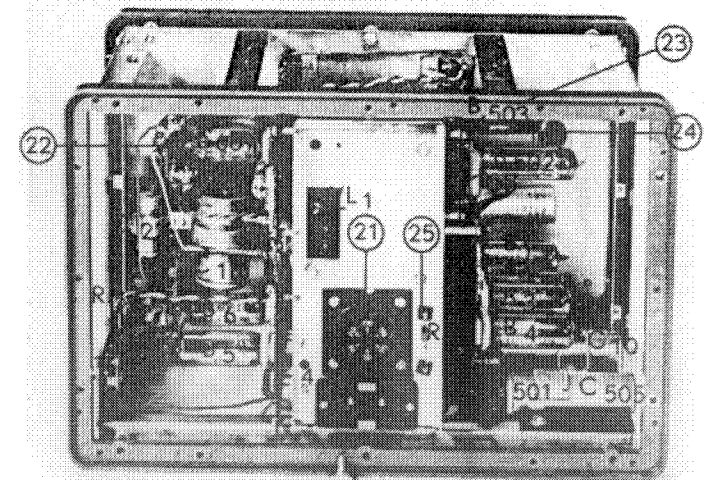

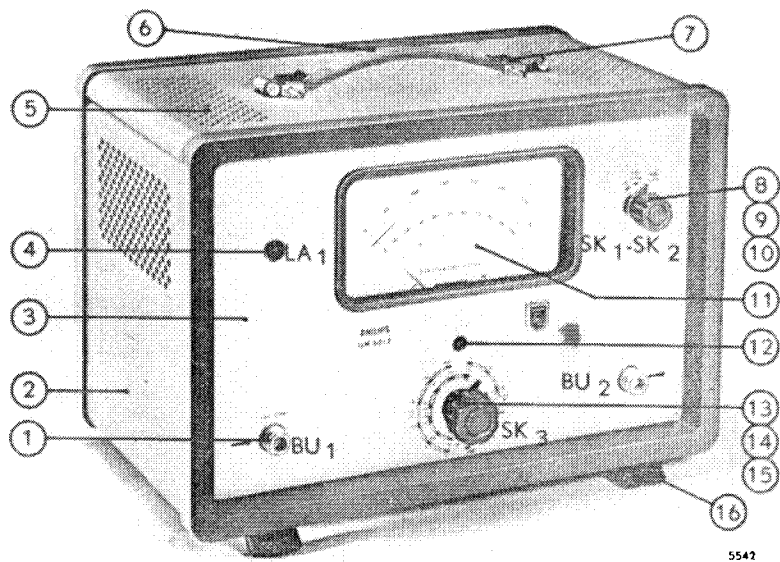

Fig. 14. Front view

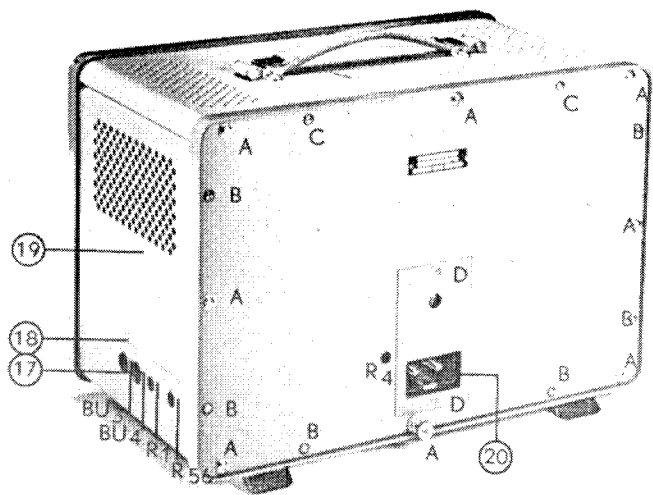

Fig. 15. Rear view

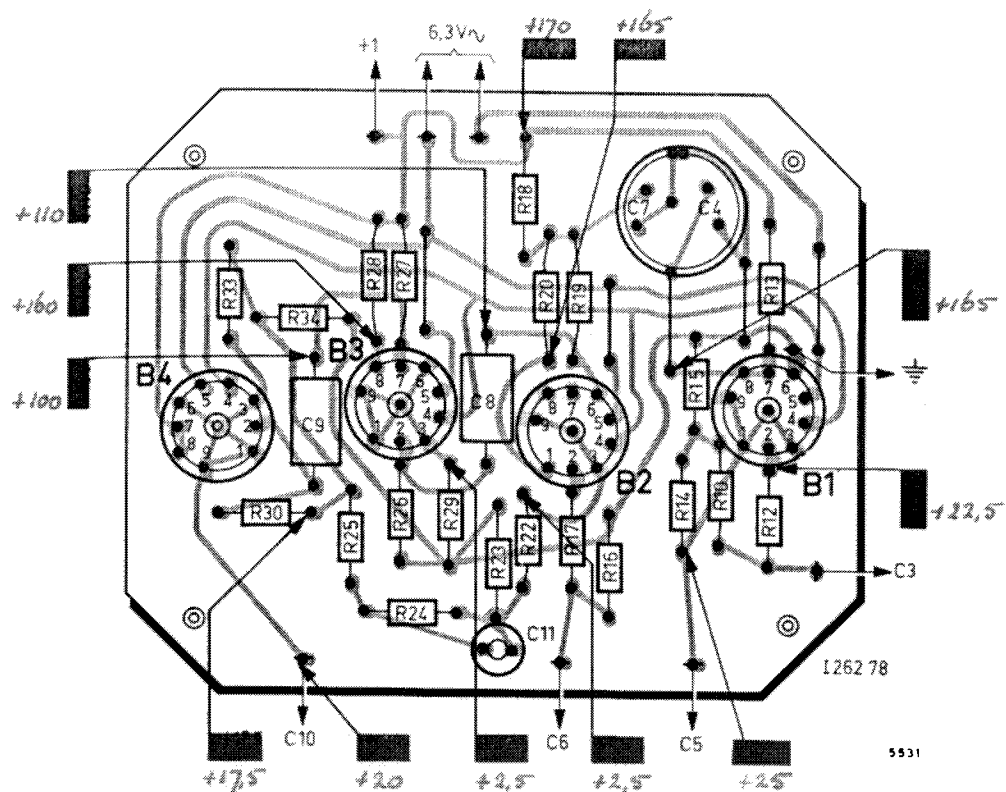

Fig. 16. Printed circuit A (pre-amplifier)

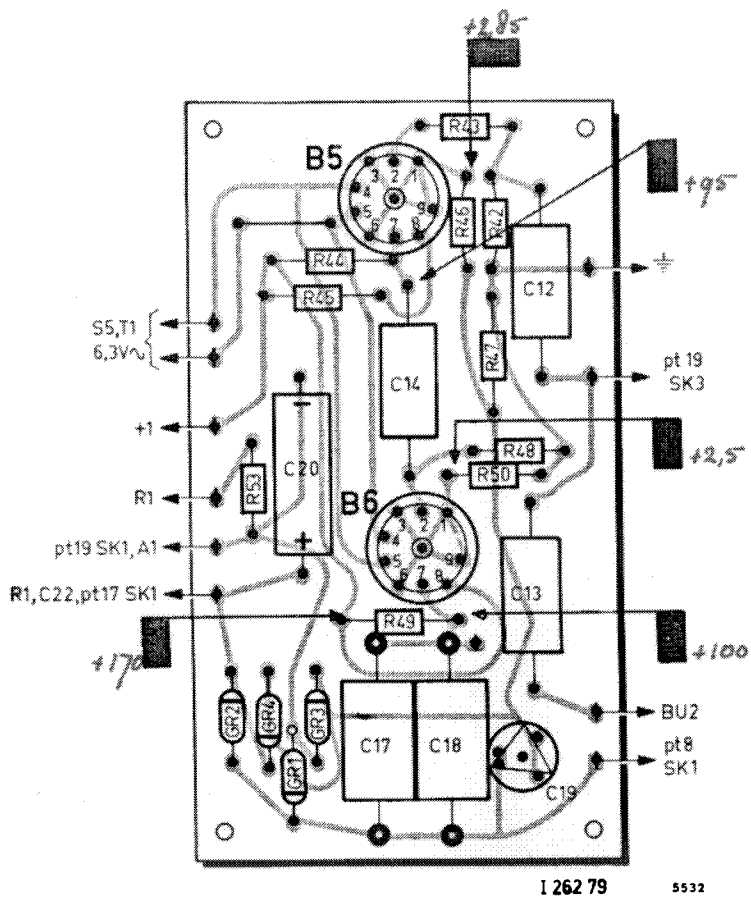

Fig. 17. Printed circuit B (output stage of amplifier)

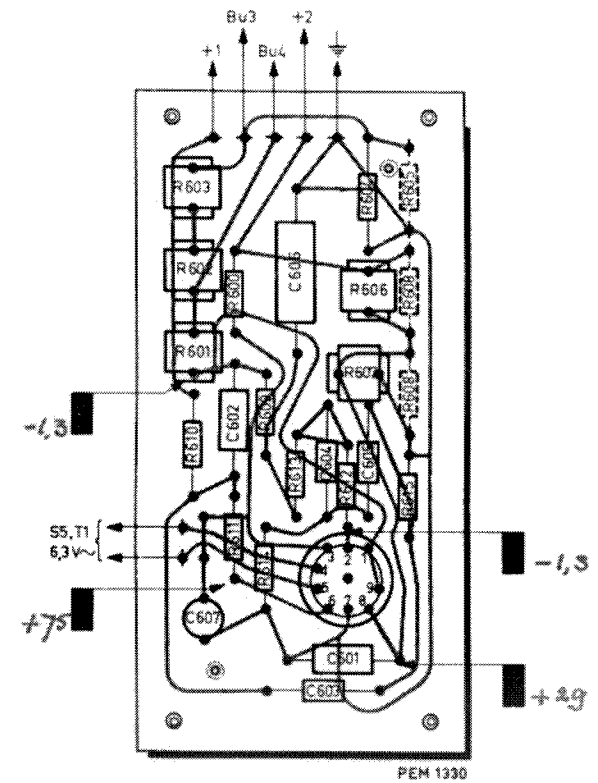

Fig. 18. Printed circuit C (calibrating part)

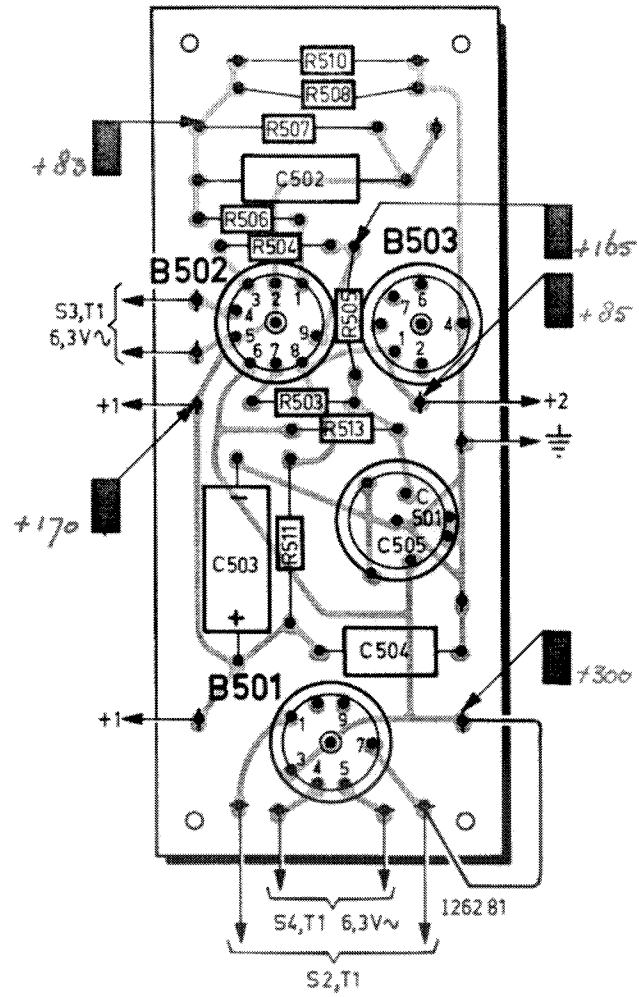

Fig. 19. Printed circuit D (supply part)

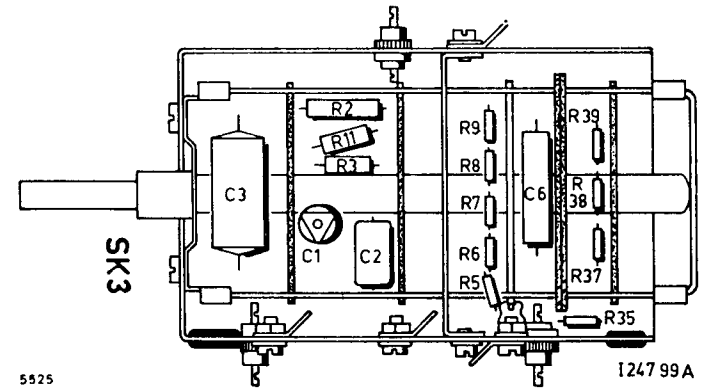

Fig. 20. Measuring-range switch

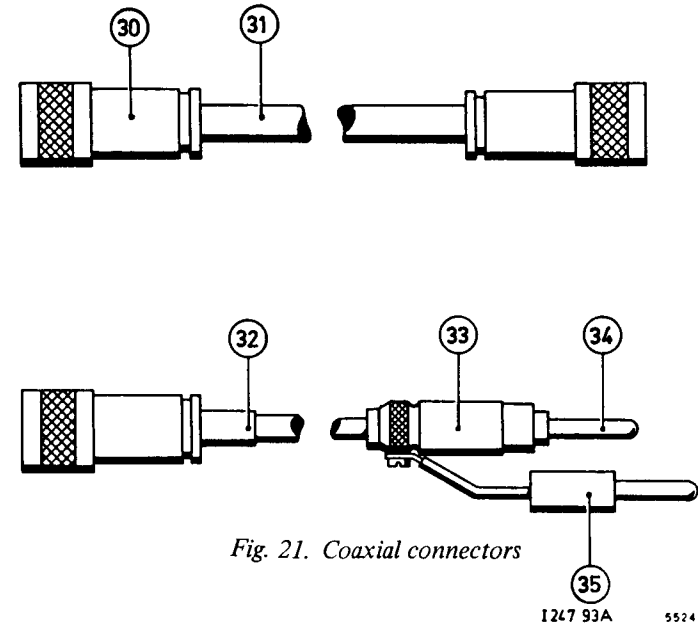

Fig. 21. Coaxial connectors

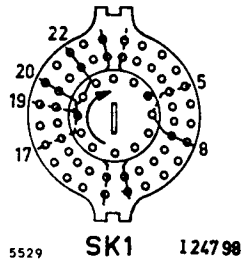

Fig. 22. Switch segment SK1

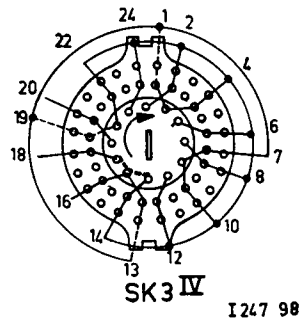
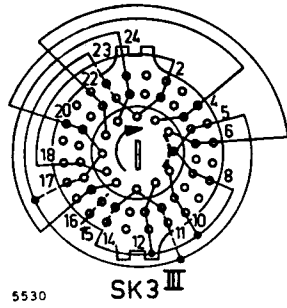
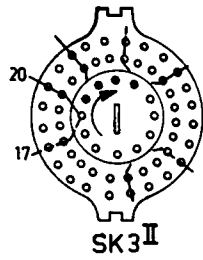
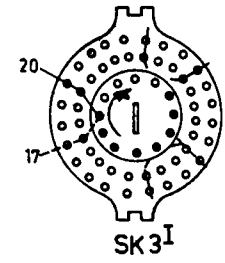

Fig. 23. Switch segments SK3

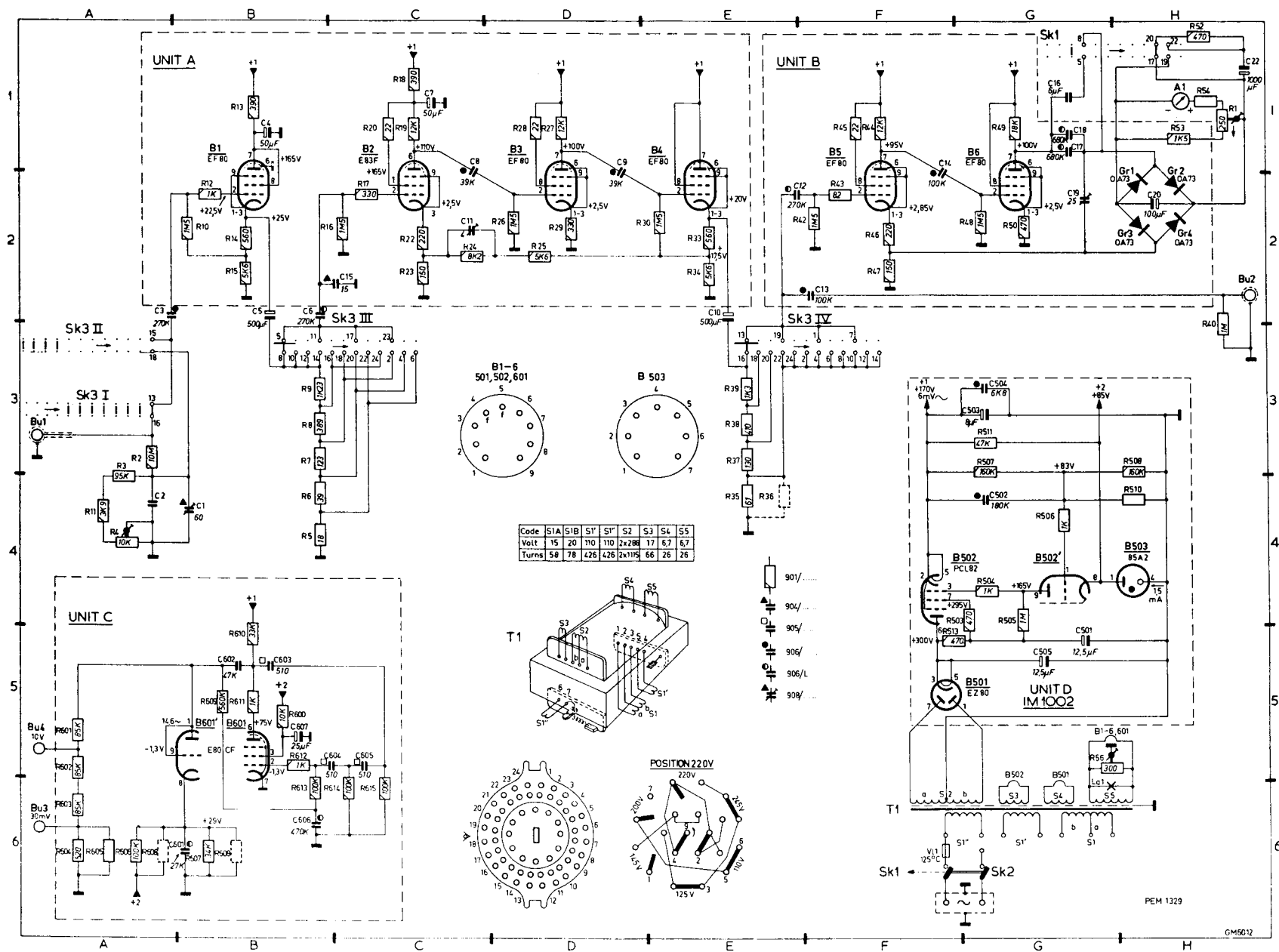

Fig. 24. Circuit diagram GM 6012