

PHILIPS *Service*

20 W Amplifier

EL 3720/00

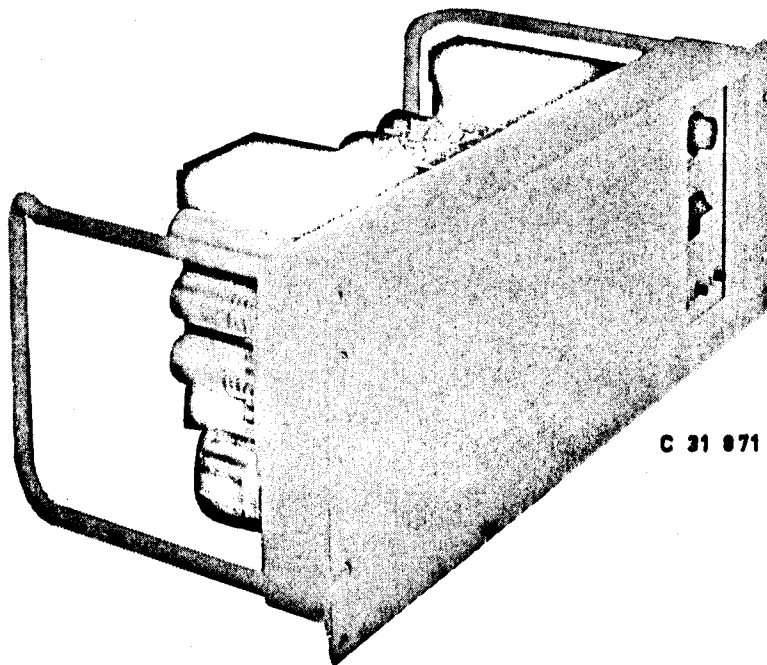

C 31 871

SERVICE INFORMATION										
------------------------	--	--	--	--	--	--	--	--	--	--

Copyright Central Service Division N.V. PHILIPS' GLOEILAMPENFABRIEKEN, Eindhoven
Confidential information for Philips Service Dealers

TABLE OF CONTENTS

- I. General
 - A. Execution
 - B. Technical Data

- II. Instructions for Installation
 - A. Connections
 - B. Adaptation and Rates
 - C. Controls
 - D. Adjusting the Mains Voltage

- III. Description of the Circuit

- IV. Checking and Measuring
 - A. Currents and voltages of the valves
 - B. Measuring in steps
 - C. Frequency characteristic

- V. List of mechanical component parts

- VI. List of electrical component parts

Figures

- Fig. 1 Front view
- 2 Measuring diagram
- 3 Frequency characteristic
- 4 Distorsion characteristic
- 5 Transformer T1
- 6 Transformer T2
- 7 Transformer T3
- 8 Circuit diagram

I. GeneralA. Execution

EL 3720/00

This 20 W monitor amplifier is specially intended for studio purposes.
The apparatus is suitable for mounting into standard 19" rack

B. Technical Data

	Input transformer ratio	
	<u>1:1</u>	<u>1:3</u>
Sensitivity	750 mV	250 mV
Source impedance	< 20,000 Ω	< 2000 Ω
Input impedance at 30-15,000 c/s	> 40,000 Ω	> 4000 Ω
Output voltages at 20 W	100 V 17 V	12 V
Min. load impedances	500 Ω 14 Ω	7 Ω
Damping factor	7	
Frequency response	See characteristic	
Distortion at 20 W		
at 1000 C/s	< 0.2 %	
from 50-10,000 c/s	< 0.5 %	
from 30-15,000 c/s	< 1 %	
Hum and noise level	< -75 dB	
Power consumption	150 W	
Output power	20 W	
Mains voltage	110 V or 220 V	
Mains frequency	40 - 100 c/s	
Valve complement	1 x EF 86	
	2 x EF 80	
	2 x EL 34	
	1 x GZ 34	
Dimensions of the frame	17 $\frac{3}{8}$ " x 9 $\frac{1}{4}$ " x 6 $\frac{3}{4}$ " (440 x 235 x 170 mm)	
Nett weight	41 lbs. 2 ozs. (18.7 kg)	

II. Instructions for Installation

A. Connections

The apparatus is connected by means of a plug-in block fitted on the rear side of the chassis.

The connections are distributed over the pins as follows :

Pin 1-a with 2-b	Connection for	14 Ω	loudspeaker
1-b 2-b	"	500 Ω	"
2-a 2-b	"	7 Ω	"

3-a)
3-b) Not connected

4-a)
4-b) Mains voltage

5-a)
5-b) Not connected

6-a)
6-b)

Connections for a measuring instrument "Philips type P 807 30" for measuring the cathode currents of the tubes.

Pin 6-b is also the earth terminal of the apparatus.

The chassis is connected to this pin by means of a 10 ohm resistor.

7-a)
7-b) Not connected

8-a)
8-b)

Input (free from earth)

N.B. In some apparatus the indications I and II are used instead of a and b.

B. Adaptation and Values

The input transformer T3 presents two possibilities of adaptation namely 40,000 Ω (1:1) and 4,000 Ω (1:3)

To get a transformer ratio of 1:1 we have to connect the terminals 3 and 4 of the plug-in block.

To get a transformer ratio of 1:3 we should connect the terminals 2 and 5.

In both cases the input signal is determined by the terminals 1 and 6.

For adjustment of this transformer the front panel must be removed.

The output transformer T2 has 3 possibilities for adapting viz.

Pins	Output voltage	Min. load impedance
2-b and 1-b	100 V	500 Ω
2-b and 1-a	17 V	14 Ω
2-b and 2-a	12 V	7 Ω

The 100 V output which is most frequently used is adapted according to the method of constant voltage or according to the impedance method.

The 7 V and 14 V outputs are intended for the connection of headphone or low ohmic loudspeakers.

In the case of adaptation according to the method of constant voltage all loudspeakers to be connected are connected in parallel with the amplifier output.

The only condition to apply is that the total power of the loudspeakers may not be higher than the power of the amplifier.

Amplifier and loudspeakers are so constructed that they supply or draw respectively their nominal power at a definite voltage. The sound volume and also the sound quality are independent of the number of loudspeakers to be connected.

In the case of adaptation according to the impedance method one should take care that the common loudspeaker impedance may never be lower than the minimum load impedance of the amplifier at a definite output voltage. Load impedances which are greater than the minimum load impedance are, however, admissible and do not influence the reproduction quality.

C. Controls

At the right side on the front of the apparatus we find a control panel on which the following controls are found :

From top to bottom :

- a. Fuse holder for the mains safety fuse.
- b. Mains switch SK1. Upwards "on", downwards "off".
- c. From left to right 3 push buttons, SK2, SK3 and SK4 by means of which the meter that may be connected to the pins 6-a and 6-b can be switched on.

D. Adjusting the Mains Voltage

If we remove the front panel we see at the right side, near the bottom the change-over strip for the mains voltage. (See fig. 1.)
For 220 V applies change strip between point 2 and 3.
For 110 V applies change strip between point 1 and 2.

III. Description of the circuit

The input signal is sent by way of the input transformer T3 (1:1) valve B1 amplifier and opposite phase valves B2 and B3 and resistances R18 and R19 to the push pull output stage B4 and B5.

A negative feed back voltage emanating from S3 of the output transformer T2 is passed to the cathode of B1.

The anode voltages of the valves are supplied by B6.

The cathode currents can be controlled by a measuring instrument (1 mA, 100 mV type P 807 30) connected to the terminals 6-a and 6-b of the male connecting block.

When depressing the buttons B1 (SK2), B2-B3 (SK3) or B4-B5 (SK4) the indication of the instrument needs always to be 40-60 scale divisions.

IV. Checking and Measuring

A. Currents and voltages of the valves

- * The measurements are carried out without input signal.
- * The use of the Philips meter "type P 807 30" is recommended.
- * The voltages are measured with respect to earth.

<u>Valve</u>	<u>B1</u>	<u>B2 or B3</u>	<u>B4 or B5</u>	<u>B6</u>	
Measuring	EF86	EF80	EL34	GZ34	
Va	183	250	402	-	V
Ia	3.8	9.25	65	-	mA
Vg2	142	137	402	-	V
Ig2	0.8	2.55	10	-	mA
Vk	-1.95	-47	-30	-	V
Vf	6.15 -6.45	6.15-6.45	6.15-6.45	4.85-5.15	V
"Range of the meter" :	8.7	40	270	-	mA
Indication :	53	59	56	Scale divisions	

By the "range of the meter" we understand the cathode current at maximum deflection of the meter.

The meter P 807 30 gives the following indications :

For B1 : the sum of Ia and Ig2.

For B2 + B3 : sum of Ia and Ig2 of both tubes together

For B4 + B5 : sum of Ia and Ig2 of both tubes together

B. Measuring in steps

- Connect the amplifier as shown in fig. 2.
- Set the signal generator to 1000 c/s.
- Switch on the amplifier.
- Apply such an input signal, that the voltage across the load resistor is 100 V.
- The values stated below should now be found at the following points of fig. 7.

Point A	600 mV
B	520 mV
C	530 mV
D	400 mV
E	400 mV
F	200 mV
G1 and G2	12 V
H1 and H2	12 V
K1 and K2	170 V
L	100 V

C. Frequency characteristic

- Connect the amplifier as shown in fig. 2.
- Set the signal generator to 1000 c/s.
- Switch on the amplifier.
- Apply such an input signal that the voltage across the load resistance amounts to 50 V.
- Measure the output voltage by means of a constant input voltage as a function of the frequency.
- The values measured are shown in the characteristic of fig. 3.

V. List of Mechanical Component Parts

<u>Pos.</u>	<u>Code number</u>	<u>Description</u>
1	V3 607 02	Plug socket (16-pole)
2	976/S8x17	Tube holder (octal)
3	974/4x50	Safety fuse holder
4	970/01AA	Sliding switch (bipolar)
5	V3 578 04	Press switch
6	974/2x20	Safety fuse holder
7	976/9x12	Tube holder (noval)
8	V3 607 01	16 pin plug

VI. List of Electrical Component Parts

<u>Pos.</u>	<u>Code number</u>	<u>Description</u>
T1	V3 617 14	Supply transformer
T2	V3 622 33	Output transformer
T3	EL 6800	Input transformer
VB	V3 693 22	Spark gap 400 V
VL1	974/V1000	Safety fuse 1 A (220 V)
	974/V2000	Safety fuse 2 A (110 V)
VL2	08 143 00	Safety fuse 10 A (6.3 V)

Capacitors

C1	906/470K	Paper	0.47	μF	125 V	10 %
C2	912/R25+25	Electrolytic	25+25	μF	500 V	
C3	905/120E	Mica	120	pF	500 V	10 %
C4	912/R25+25	Electrolytic	25+25	μF	500 V	
C5	906/100K	Paper	0.1	μF	400 V	10 %
C6	906/33K	Paper	33000	pF	125 V	10 %
C8	906/V470K	Paper	0.47	μF	700 V	10 %
C9	906/V470K	Paper	0.47	μF	700 V	10 %
C10	912/R25+25	Electrolytic	25+25	μF	500 V	
C11	912/R25+25	Electrolytic	25+25	μF	500 V	
C12	C435AL/H64	Electrolytic	64	μF	64 V	
C13	905/680E	Mica	680	pF	500 V	10 %

Resistors

R1	902/470K	Carbon	470	kΩ	0.5	W	10	%
R2	901/360E	Carbon	360	Ω	0.25	W	2	%
R3	901/110E	Carbon	110	Ω	0.25	W	1	%
R4	901/750E	Carbon	750	Ω	0.25	W	1	%
R5	901/15K	Carbon	15000	Ω	0.25	W	2	%
R6	902/100K	Carbon	100	kΩ	0.5	W	10	%
R7	902/10K	Carbon	10	kΩ	0.5	W	10	%
R8	902/33K	Carbon	33	kΩ	0.5	W	10	%
R9	901/470K	Carbon	0.47M	Ω	0.5	W	5	%
R10	B8 305 08B/33K	Carbon	33	kΩ	2	W	10	%
R11	901/150K	Carbon	0.15M	Ω	0.5	W	5	%
R12	902/1M	Carbon	1	MΩ	0.5	W	10	%
R13	902/1K	Carbon	1000	Ω	0.5	W	10	%
R14	B8 305 08B/2K2	Carbon	2200	Ω	2	W	10	%
R15	901/33E	Carbon	33	Ω	0.25	W	1	%
R16	901/1K3	Carbon	1300	Ω	0.25	W	1	%
R17	900/39K	Carbon	39	kΩ	1	W	10	%
R18	E 003 AG/D15K	Carbon	15	kΩ	1	W	2	%
R19	E 003 AG/D15K	Carbon	15	kΩ	1	W	2	%
R20	902/470K	Carbon	0.47M	Ω	0.5	W	10	%
R21	902/470K	Carbon	0.47M	Ω	0.5	W	10	%
R22	938/A2K7	Wire wound	2700	Ω	5.5	W	10	%
R23	902/1K	Carbon	1000	Ω	0.5	W	10	%
R24	902/1K	Carbon	1000	Ω	0.5	W	10	%
R25	B8 305 08B/470E	Carbon	470	Ω	2	W	10	%
R26	931/A220E	Wire wound	200	Ω	16		5	%
R27	901/W5E6	Wire wound	5.6	Ω	0.4	W	1	%
R28	901/1K5	Carbon	1500	Ω	0.25	W	1	%
R29	902/10E	Carbon	10	Ω	0.5	W	10	%
R30	902/10E	Carbon	10	Ω	0.5	W	10	%
R31	902/5K6	Carbon	5600	Ω	0.5	W	10	%
R32	E 003 AG/D18K	Carbon	18000	Ω	1	W	2	%
R33	E 003 AG/D18K	Carbon	18000	Ω	1	W	2	%

CL/KJ

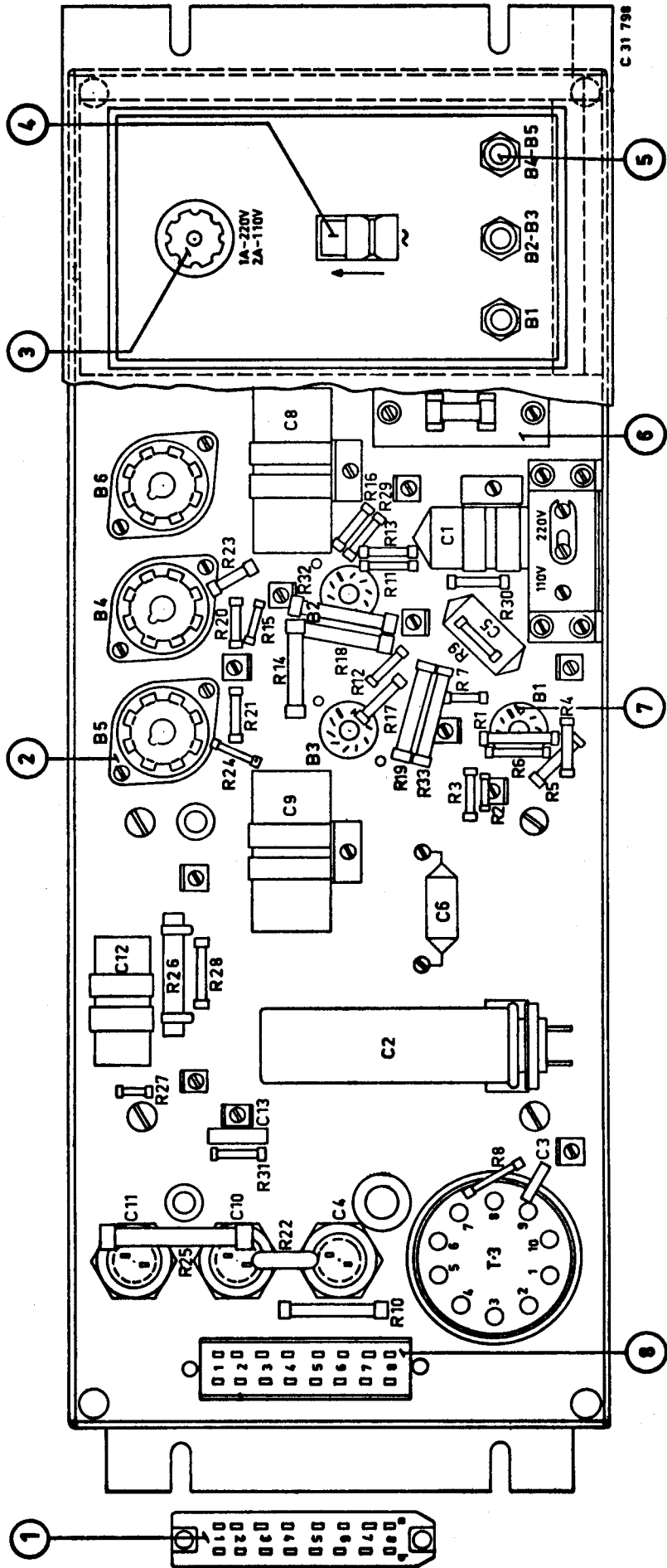

Fig. 1

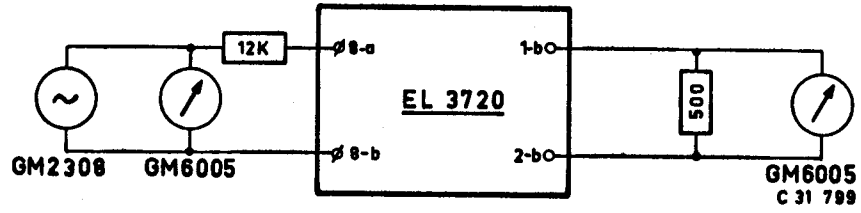

Fig2

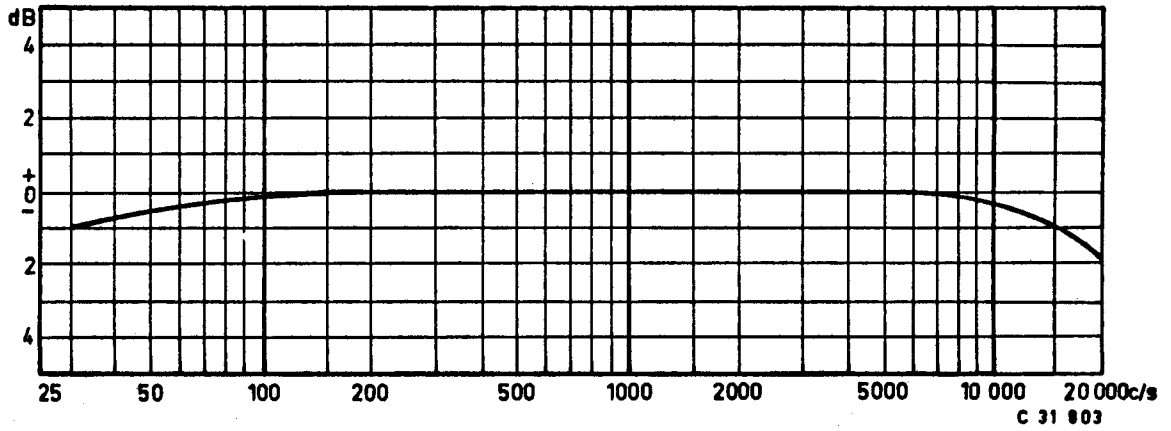

Fig3

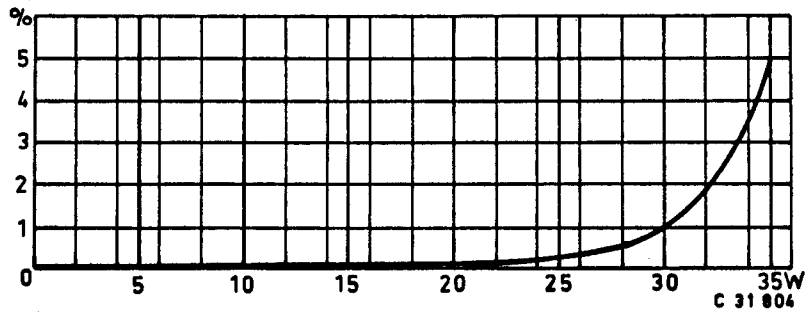

Fig.4

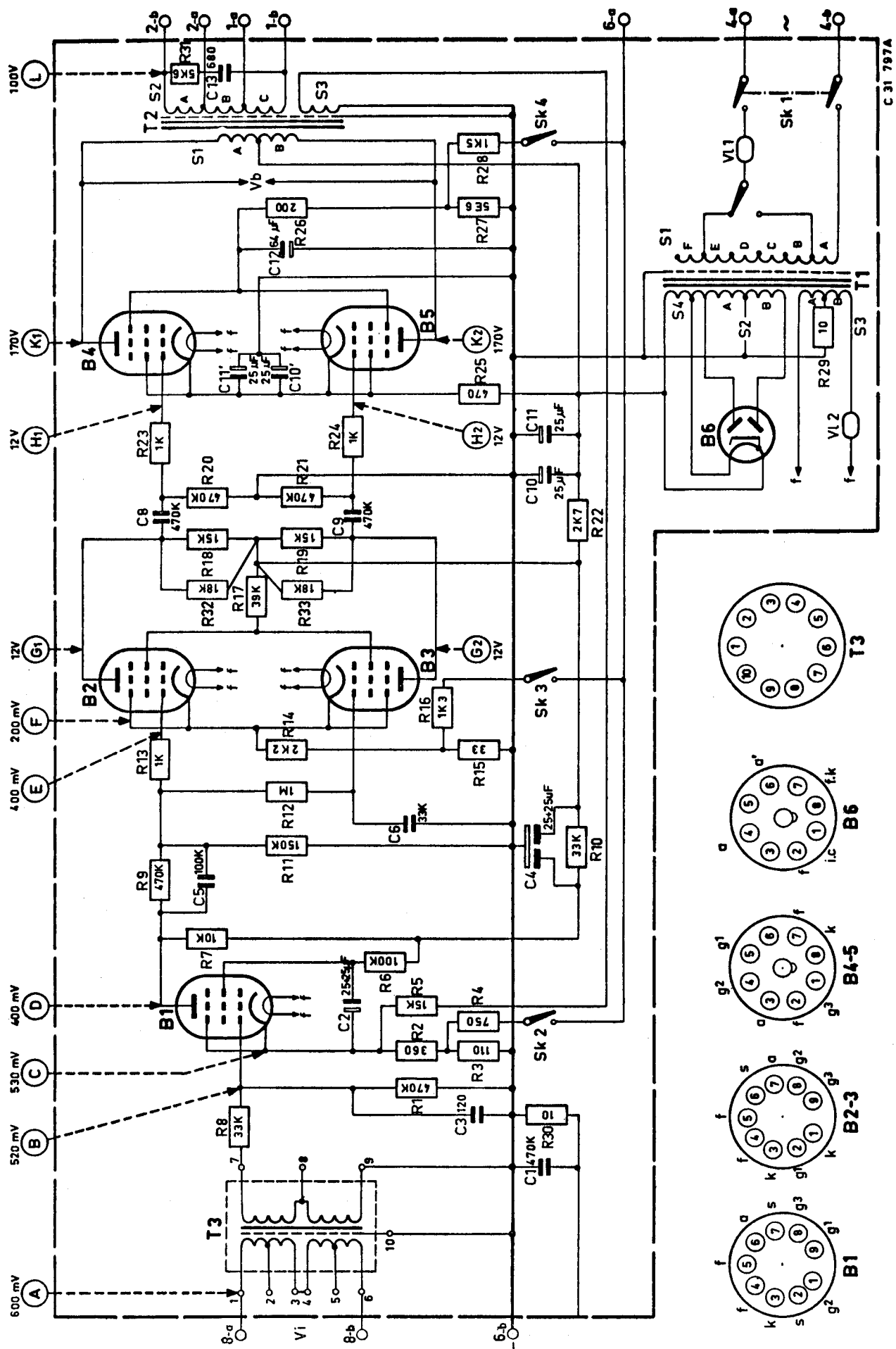
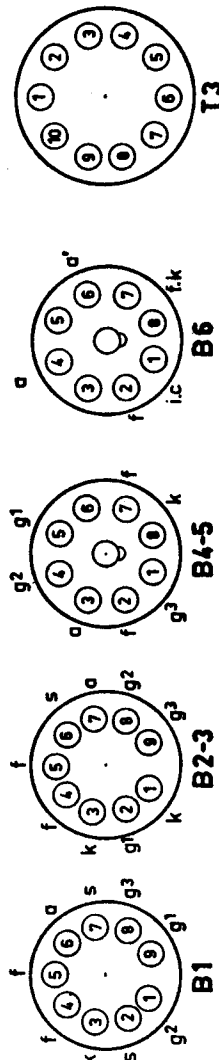

Fig. 8



C 31 7874