

## CMA 1233 CARCINOTRON

The CMA.1233 is a rugged, compact, electronically tunable, crossfield, backward wave oscillator. Its light weight makes it suitable for airborne equipments. Sturdy metal-ceramic construction insures reliable performance in spite of severe environmental conditions.

This M type carcinotron provides an output of at least 250 W over the frequency range of 0.85 to 1.1 GHz. The tube tunes over the entire frequency range by changing the line or sole voltage.

It can be amplitude modulated through its anode. Frequency modulation can be obtained by line or sole voltage variations.

The CMA.1233 uses integral permanent magnet focusing. Liquid cooling insures operation in a wide temperature range.

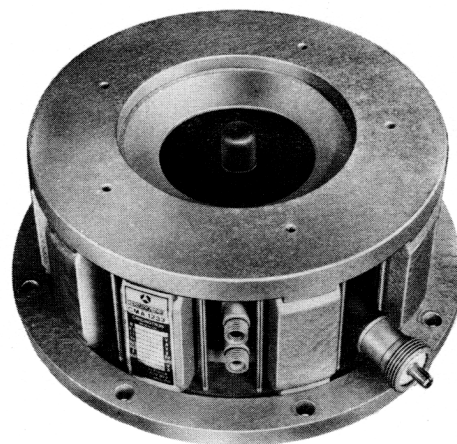

### GENERAL CHARACTERISTICS

#### Electrical (1)

	min.	max.	
Heater voltage .....	6.3		V
Heater current .....	3.5	6.0	A
Output power .....	250	-	W
Frequency range .....	0.85	1.1	GHz
Interelectrodes capacitances :			
Sole to all other electrodes .....	-	105	pF
Anode to all other electrodes .....	-	18	pF
Line to all other electrodes .....	-	105	pF
Sole voltage .....	-0.5	-1.5	kV
Sole current .....	-80	0	mA
Grid voltage .....	-0.1	-1.0	kV
Grid current .....	-	1	mA
Anode voltage .....	-	2.0	kV
Anode current .....	-0.25	+2.0	mA
Line voltage .....	1.5	5.0	kV
Line current .....		350	mA

#### Mechanical

Operating position .....	any
Dimensions .....	see drawing
Weight .....	17 kg
RF output connector .....	coaxial

(1) - All voltages are referred to the cathode.



**COOLING**

**WATER**

Water flow . . . . .	min.	2	l/mn
Pressure drop (1) . . . .	max.	0.05	bar
Coolant temperature . . .	max.	80	°C
Absolute inlet pressure .	max.	2.7	bar

**COOLANOL 35**

Liquid flow . . . . .	min.	4	l/mn
Pressure drop (1) . . . .	max.	0.25	bar
Coolant temperature . . .	max.	80	°C
Absolute inlet pressure .	max.	2.7	bar

**ABSOLUTE RATINGS**

( non simultaneous values )

Warm-up time . . . . .	min.	5	mn	Sole voltage (3) . . . . .	min.	-50	V
Heater voltage . . . . .	6.1	6.6	V	Grid voltage . . . . .	0	-1.1	kV
Heater surge current . . .	-	10	A	Anode voltage . . . . .	-	2.2	kV
Load VSWR (2) . . . . .	-	3:1		Line voltage . . . . .	-	5.2	kV
Ambient temperature . . .	-40	+110	°C	Line current . . . . .	-	375	mA
Vibration : 5 to 15 Hz -	0.5	g		Acceleration . . . . .	-	15	g
15 to 500 Hz -	2	g					

**TYPICAL OPERATION**

Heater voltage . . . . .	6.3	V	Oscillating frequency :	0.85	1.10	GHz
Heater current . . . . .	5.0	A				
Sole voltage . . . . .	-1.1	kV	Anode voltage . . . . .	1.26	1.25	kV
Grid voltage . . . . .	-0.3	kV	Line voltage . . . . .	2.60	4.75	kV
Grid current . . . . .	0	mA	Sole current . . . . .	-15	-60	mA
Line current . . . . .	350	mA	Output power . . . . .	370	570	W

**OPERATING INSTRUCTIONS**

**Application of voltages**

- Before applying any voltages to the tube, check the coolant flow.
- Apply the heater voltage and allow at least five minutes for the cathode to warm-up.
- Apply grid and sole voltages.
- Apply line voltage. The minimum value of the line voltage given on the tube label is for operating at the lower frequency ; when starting the tube, the voltage applied should be slightly higher.
- Apply reduced anode voltage. Increase the voltage slowly and simultaneously check the line voltage, which should not decrease.
- Adjust the voltages for each particular operation.
- Apply modulation voltages.

**Removal of voltages**

- First remove the modulation voltages.
- Remove anode voltage.
- Remove line voltage.
- Remove sole, grid and heater voltages.
- Turn off coolant supply to the tube.

**Caution**

Minimum distance of 15 cm should be kept between the tube and all other magnetic materials.

(1) - 1 bar = approximately 15 psi.  
 (2) - The tube may require a load isolator at load VSWR exceeding 1.5 : 1 to maintain the tube performances.  
 (3) - These minimum and maximum ratings are the allowable deviation from the nominal value given for each tube.



### Characteristic curves

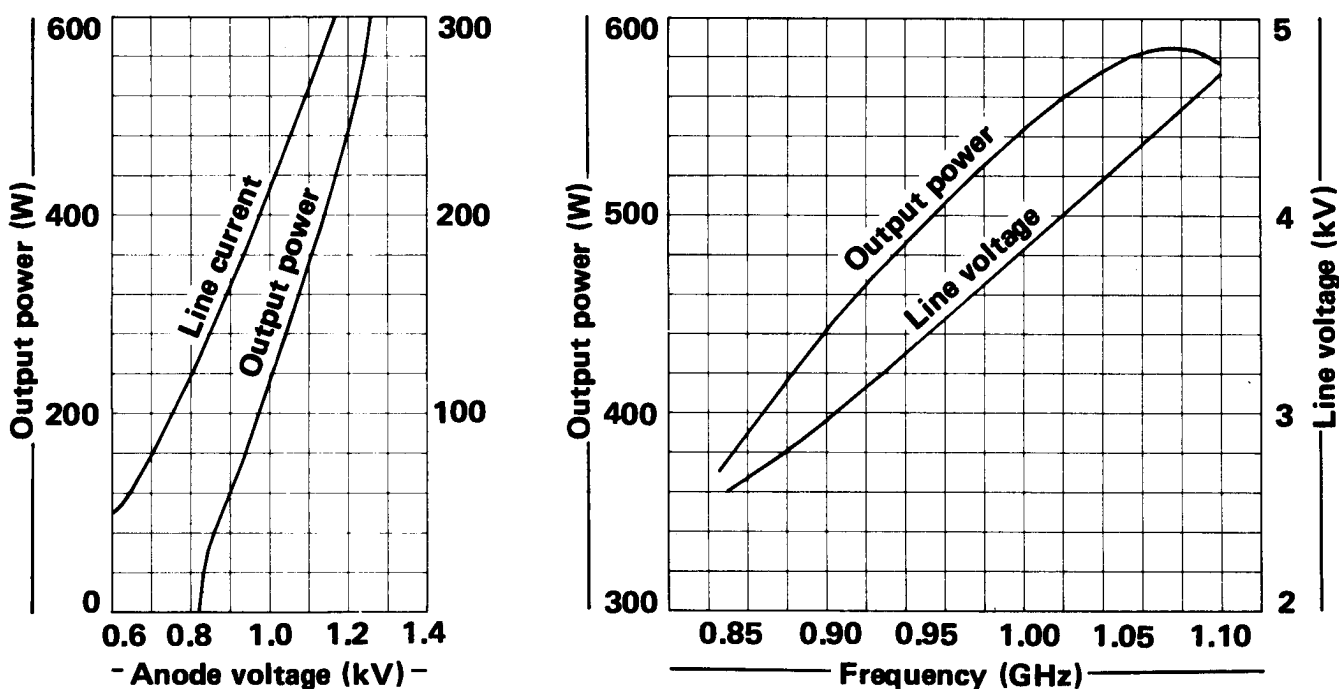

### Supply diagram

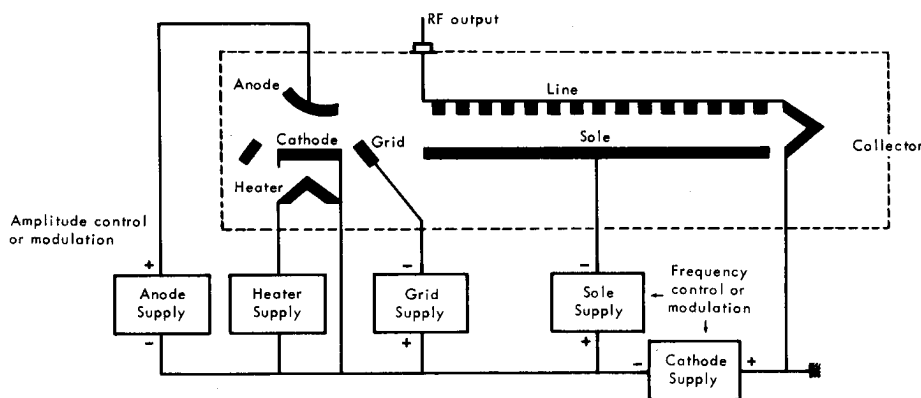



**OUTLINE DRAWING**

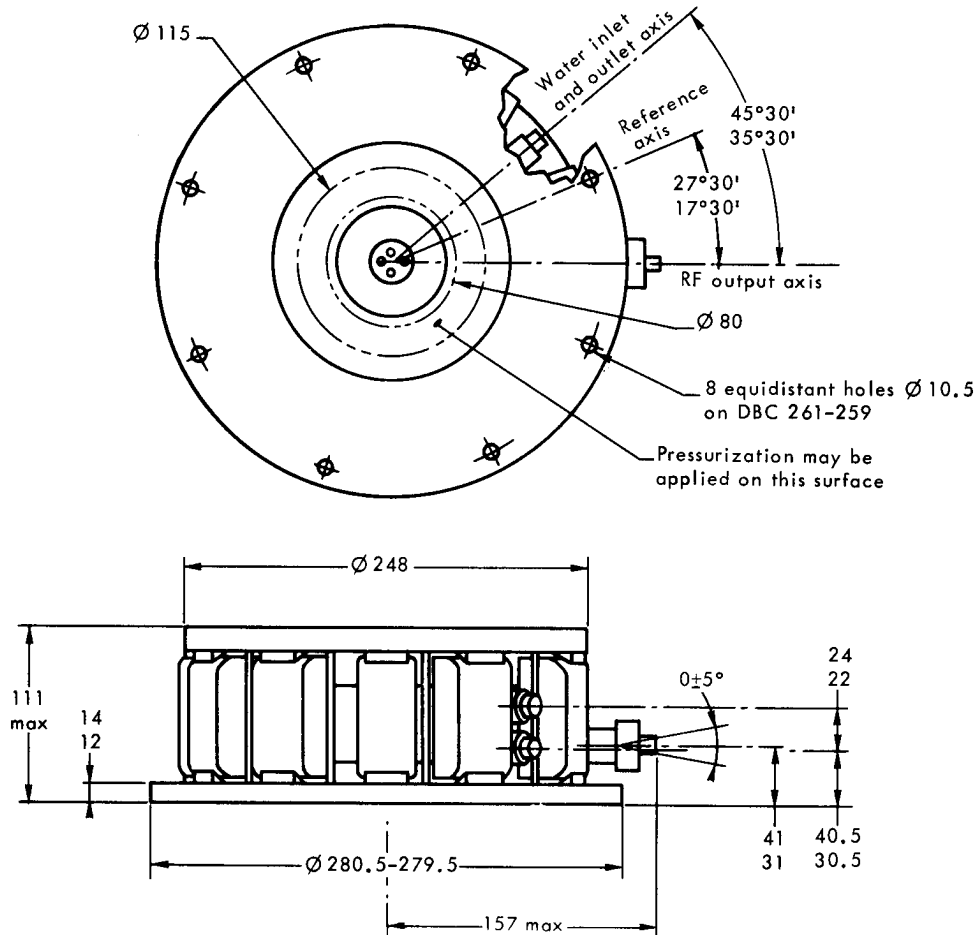

**Water connection**

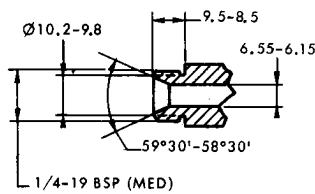

**Pin arrangement**

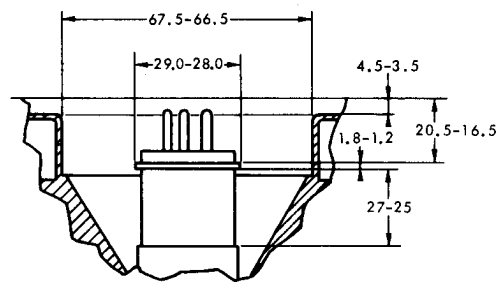

**RF output**

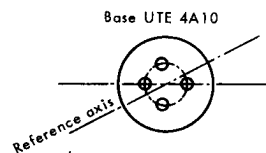
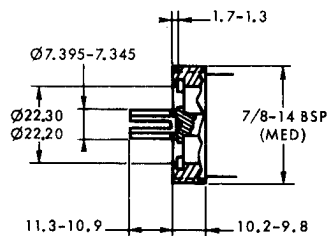

Dimensions in mm

